

Automation Panel 900

User's Manual

Version: **2.21 (March 2015)**
Model no.: **MAAP900-ENG**

All information contained in this manual is current as of its creation/publication. B&R reserves the right to change the contents of this manual without notice. The information contained herein is believed to be accurate as of the date of publication; however, Bernecker + Rainer Industrie-Elektronik Ges.m.b.H. makes no warranty, expressed or implied, with regard to the products or documentation contained within this manual. In addition, Bernecker + Rainer Industrie-Elektronik Ges.m.b.H. shall not be liable for any incidental or consequential damages in connection with or arising from the furnishing, performance or use of the product(s) in this documentation. Software names, hardware names and trademarks are registered by their respective companies.

Chapter 1: General information

Chapter 2: Technical data

Chapter 3: Installation

Chapter 4: Software

Chapter 5: Standards and certifications

Chapter 6: Accessories

Chapter 7: Maintenance and service

Appendix A

Chapter 1 General information.....	8
1 Manual history.....	8
2 Safety guidelines.....	11
2.1 Intended use.....	11
2.2 Protection against electrostatic discharge.....	11
2.2.1 Packaging.....	11
2.2.2 Guidelines for proper ESD handling.....	11
2.3 Policies and procedures.....	11
2.4 Transport and storage.....	12
2.5 Installation.....	12
2.6 Operation.....	12
2.6.1 Protection against touching electrical parts.....	12
2.6.2 Environmental conditions - Dust, moisture, corrosive gases.....	12
2.6.3 Viruses and dangerous programs.....	12
2.7 Environmentally friendly disposal.....	13
2.7.1 Separation of materials.....	13
3 Organization of safety notices.....	14
4 Guidelines.....	14
5 Overview.....	15
Chapter 2 Technical data.....	17
1 Introduction.....	17
2 Complete system.....	18
2.1	18
2.2 Temperature specifications.....	19
2.2.1 Maximum ambient temperature.....	19
2.2.2 Minimum ambient temperature during operation.....	20
2.3 Humidity specifications.....	21
2.4 Power consumption.....	22
2.5 Block diagrams.....	23
2.5.1 AP900 block diagram.....	23
2.5.2 AP900 block diagram with DVI Link.....	23
2.5.3 AP900 with SDL receiver - Block diagram.....	24
2.5.4 AP900 with SDL transceiver - Block diagram.....	24
2.5.5 AP900 with SDL3 receiver - Block diagram.....	25
2.6 Serial number sticker.....	26
3 Individual components.....	27
3.1 Display units.....	27
3.1.1 Automation Panel 10.4" VGA.....	27
3.1.2 Automation Panel 12.1" SVGA.....	57
3.1.3 Automation Panel 15" XGA.....	62
3.1.4 Automation Panel 17" SXGA.....	82
3.1.5 Automation Panel 19" SXGA.....	87
3.1.6 Automation Panel 21.3" UXGA.....	92
3.2 Automation Panel Link plug-in cards.....	97
3.2.1 5DL DVI.1000-01.....	98
3.2.2 5DLSDL.1000-00.....	101
3.2.3 5DLSDL.1000-01.....	103
3.2.4 5DLSD3.1000-00.....	105
Chapter 3 Installation.....	109
1 Installation.....	109
1.1 Important installation information.....	109
1.2 Installation with clamping blocks.....	109
2 Mounting orientation.....	111
2.1 Mounting orientation 0°.....	111
2.2 Mounting orientation 45°.....	111

3 Spacing for air circulation.....	113
4 Fastening cables.....	114
5 Functional grounding clip.....	114
6 General instructions for performing temperature testing.....	115
6.1 Procedure.....	115
6.2 Evaluating temperatures in Windows operating systems.....	115
6.2.1 Evaluating with the B&R Control Center.....	115
6.2.2 Evaluating with the BurnInTest tool from Passmark.....	116
6.3 Evaluating temperatures in operating systems other than Windows.....	118
6.4 Evaluating the measurement results.....	118
7 Connection examples.....	119
7.1 Selecting display units.....	119
7.2 One Automation Panel 900 system via onboard DVI.....	120
7.2.1 Base system requirements.....	120
7.2.2 Link modules.....	120
7.2.3 Cables.....	120
7.2.4 Possible Automation Panel devices, resolutions and segment lengths.....	121
7.2.5 BIOS settings.....	121
7.3 One Automation Panel 900 system via onboard SDL.....	122
7.3.1 Base system requirements.....	122
7.3.2 Link modules.....	122
7.3.3 Cables.....	122
7.3.4 Settings in BIOS.....	123
7.4 Four Automation Panel 900 systems via onboard SDL.....	124
7.4.1 Base system requirements.....	124
7.4.2 Link modules.....	124
7.4.3 Cables.....	124
7.4.4 Settings in BIOS.....	125
7.5 One Automation Panel 900 via SDL3.....	126
7.5.1 Base system requirements.....	126
7.5.2 Link modules.....	126
7.5.3 Cables.....	126
7.5.4 Settings in BIOS.....	127
8 Connecting peripheral USB devices.....	128
8.1 Remote connection to Automation Panel 900 via DVI.....	128
8.2 Remote connection to Automation Panel 800 / 900 via SDL.....	129
8.3 Remote connection to Automation Panel 900 via SDL3.....	130
9 Key and LED configurations.....	131
9.1 Automation Panel 10.4" VGA.....	132
9.1.1 Automation Panel 5AP951.1043-01 / 5AP981.1043-01.....	132
9.1.2 Automation Panel 5AP952.1043-01 / 5AP982.1043-01.....	132
9.1.3 Automation Panel 5AP980.1043-01.....	133
9.2 Automation Panel 15" XGA.....	133
9.2.1 Automation Panel 5AP951.1505-01 / 5AP981.1505-01.....	133
9.2.2 Automation Panel 5AP980.1505-01.....	134
10 Touch screen calibration.....	135
10.1 Windows XP Professional.....	135
10.2 Windows XP Embedded.....	135
10.3 Windows Embedded Standard 2009.....	135
10.4 Windows Embedded Standard 7 Embedded / Premium.....	135
10.5 Windows CE.....	135
10.6 Windows 7 Professional / Ultimate.....	135
10.7 Windows Embedded 8.1 Industry Pro.....	135
10.8 Automation Runtime / Visual Components.....	135
11 Tips for extending the service life of the display.....	136
11.1 Backlight.....	136
11.1.1 How can the service life of the backlight be extended?.....	136

11.2 Screen burn-in.....	136
11.2.1 What causes screen burn-in?.....	136
11.2.2 How can screen burn-in be avoided?.....	136
12 Pixel errors.....	136
Chapter 4 Software.....	137
1 B&R Automation Device Interface (ADI) - Control Center.....	137
1.1 Functions.....	137
1.2 Installation.....	138
2 B&R Automation Device Interface (ADI) Development Kit.....	139
3 B&R Automation Device Interface (ADI) .NET SDK.....	141
4 B&R Key Editor.....	143
Chapter 5 Standards and certifications.....	145
1 Standards and guidelines.....	145
1.1 CE mark.....	145
1.2 EMC directive.....	145
1.3 Low voltage directive.....	145
2 Certifications.....	146
2.1 UL certification.....	146
2.2 GOST-R.....	146
2.3 GL certification (Germanischer Lloyd).....	146
3 SDL flex cable test description.....	149
3.1 Torsion.....	149
3.1.1 Test structure.....	149
3.1.2 Test conditions.....	149
3.1.3 Individual tests.....	149
3.2 Cable drag chain.....	150
3.2.1 Test structure.....	150
3.2.2 Test conditions.....	150
3.2.3 Individual tests.....	150
Chapter 6 Accessories.....	151
1 Power connectors.....	151
1.1 0TB103.9x.....	151
1.1.1 General information.....	151
1.1.2 Order data.....	151
1.1.3 Technical data.....	151
2 Terminal blocks.....	153
2.1 0TB103.8.....	153
2.1.1 General information.....	153
2.1.2 Order data.....	153
2.1.3 Technical data.....	153
3 Legend strip templates.....	154
3.1 5AC900.104X-xx.....	154
3.2 General information.....	154
3.3 Order data.....	154
4 Cables.....	155
4.1 DVI cables.....	155
4.1.1 5CADVI.0xxx-00.....	155
4.2 SDL cables.....	158
4.2.1 5CASDL.0xxx-00.....	158
4.3 SDL cables with 45° male connector.....	161
4.3.1 5CASDL.0xxx-01.....	161
4.4 SDL flex cables.....	164
4.4.1 5CASDL.0xxx-03.....	164
4.5 SDL flex cables with extender.....	167

4.5.1 5CASDL.0xx0-13.....	167
4.6 SDL3 cables.....	171
4.6.1 5CASD3.xxxx-00.....	171
4.7 USB cables.....	174
4.7.1 5CAUSB.00xx-00.....	174
4.8 RS232 cables.....	175
4.8.1 9A0014.xx.....	175
5 USB interface cover.....	177
5.1 5AC900.1200-00.....	177
5.1.1 General information.....	177
5.1.2 Order data.....	177
5.2 5AC900.1200-01.....	177
5.2.1 General information.....	177
5.2.2 Order data.....	177
5.3 5AC900.1201-00.....	177
5.3.1 General information.....	177
5.3.2 Order data.....	177
5.4 5AC900.1201-01.....	178
5.4.1 General information.....	178
5.4.2 Order data.....	178
6 USB flash drives.....	179
6.1 5MMUSB.2048-00.....	179
6.1.1 General information.....	179
6.1.2 Order data.....	179
6.1.3 Technical data.....	179
6.1.4 Temperature/Humidity diagram.....	180
6.2 5MMUSB.xxxx-01.....	181
6.2.1 General information.....	181
6.2.2 Order data.....	181
6.2.3 Technical data.....	181
6.2.4 Temperature/Humidity diagram.....	182
7 AP900 fluorescent tubes.....	183
7.1 General information.....	183
7.2 Order data.....	183
8 Line filter.....	184
8.1 5AC804.MFLT-00.....	184
8.1.1 General information.....	184
8.1.2 Order data.....	184
8.1.3 Technical data.....	184
8.1.4 Dimensions.....	185
8.1.5 Drilling template.....	185
8.1.6 Connecting to the end device.....	185
9 HMI Drivers & Utilities DVD.....	186
9.1 5SWHMI.0000-00.....	186
9.1.1 General information.....	186
9.1.2 Order data.....	186
9.1.3 Contents (V2.20).....	186

Chapter 7 Maintenance and service..... 189

1 Cleaning.....	189
2 Replacing the fluorescent tubes.....	190
2.1 Procedure.....	190
2.1.1 General information.....	191
2.1.2 Procedure for 12.1" Automation Panels.....	191
2.1.3 Procedure for 15" Automation Panels.....	192

Appendix A	194
1 Elo AccuTouch screen.....	194
1.1 Technical data.....	194
1.2 Temperature humidity diagram.....	195
1.3 Cleaning.....	195
2 5-wire AMT touch screen.....	196
2.1 Technical data.....	196
2.2 Temperature/Humidity diagram.....	196
2.3 Cleaning.....	196
3 Panel overlay.....	198
4 Filter glass.....	198
5 Viewing angles.....	199
6 Mounting compatibility.....	200
6.1 Compatibility overview.....	200
6.2 Compatibility details.....	201
6.2.1 Example.....	201
6.2.2 5.7" devices.....	201
6.2.3 10.4" devices.....	203
6.2.4 12.1" devices.....	204
6.2.5 15" devices.....	205
6.2.6 17" devices.....	206
6.2.7 19" devices.....	206
6.2.8 21.3" devices.....	207
7 Glossary.....	208

Chapter 1 • General information

1 Manual history

Version	Date	Change
1.0 Preliminary	14-Dec-04	<ul style="list-style-type: none"> • First version
1.1 Preliminary	22-Apr-05	<ul style="list-style-type: none"> • Updated model numbers. • Keypad devices • Legend strip templates
1.2 Preliminary	31-Jan-06	<ul style="list-style-type: none"> • Added USB interface cover (attached) 5AC900.1200-00. • Added information regarding touch screen driver. • Revised and corrected technical data for SDL cables (AWG, flex radius, etc.). • Added 20-, 25- and 30-meter SDL cables (5CASDL.0200-00, 5CASDL.0250-00 and 5CASDL.0300-00). • Conductor cross section and AWG modifications for the power connector. • Added new front view photos of all Automation Panel devices. • Updated information regarding general tolerances in accordance with DIN ISO 2768 medium in dimension diagrams. • Revised safety notices. • Changed service life of the AP920.1706-01 backlight to 50,000 hours (depends on revision). • Updated display protection information with more detailed specifications (IP20 and IP65). • Revised installation diagrams and tolerance information for dimensions.
1.30	30-Oct-06	<ul style="list-style-type: none"> • Added "ESD" section to safety notices. • Added SDL cables with 45° connector on one end 5CASDL.0018-01, 5CASDL.0050-01, 5CASDL.0100-01, 5CASDL.0150-01. • Added SDL cables with extender 5CASDL.0300-10 and 5CASDL.0400-10. • Revised Elo touch screen specification (see Appendix A). • Implemented extensive changes to the technical data for Automation Panel display units. • Updated section 5 "Standards and certifications". • Updated HMI Drivers & Utilities DVD 5SWHMI.0000-00. • Added information regarding the B&R Key Editor. • Updated section 9 "Key and LED configurations". • Updated section "Anschlussbeispiele". • "Glossary" on page 208 updated. • "USB flash drives" on page 179 updated. • Updated "SDL flex cables" on page 164 and "SDL flex cables with extender" on page 167. • Updated section 7 "Maintenance and service" on page 189. • Updated new clamping blocks and revised mounting instructions. • Updated technical data for the 12.1" Automation Panel 5AP920.1214-01.
1.40	11-Dec-06	<ul style="list-style-type: none"> • Updated 2 GB USB flash drive 5MMUSB.2048-00 from SanDisk. • Modified cable overview of connection examples. • Updated temperatures for devices in Rittal housings. • Changed installation dimensions of 5AP920.1214-01. Changed description of viewing angle. • Updated section 5 "Viewing angles" on page 199. • Updated section 6 "Mounting compatibility" on page 200. • Revised glossary. • Changed firmware names. • Updated ambient temperatures of the 12.1" Automation Panel 5AP920.1214-01. • Updated temperature humidity diagram for the 5AP920.1214-01 display unit. • Modified figure 2 "Automation Panel and Automation Panel Link insert card".
1.50	15-Feb-07	<ul style="list-style-type: none"> • Revised temperature and humidity specifications. • Revised technical data for individual components. • Changed figure Figure 67 "5AP920.1706-01 - Temperature humidity diagram" on page 85. • Updated photos of 5CASDL.0x00-13 SDL cables with an extender. • Changed Figure 126 "5CASDL.0xxx-03 - Pinout" on page 166. Deleted structure of 5CASDL.0xxx-03 SDL cables.
1.60	31-Oct-07	<ul style="list-style-type: none"> • Removed cross-references in chapter 3 "Installation" (replaced by "See the APC620 user's manual). • Revised technical data (flex radius specifications) for SDL cables. • 3 "SDL flex cable test description" on page 149 updated. • Discontinued USB flash drive 5MMUSB.0256-00 and USB flash drive 5MMUSB.1024-00. • Revised section 6 "USB flash drives" on page 179. • Revised Figure 130 "Example of the signal direction for an SDL flex cable with extender" on page 170. • Discontinued devices 5AP951.1043-01, 5AP951.1505-01, 5AP952.1043-01 and 5AP920.2138-01. • Added connection examples for X855 CPU boards and the full-size system unit with 3 PCI slots. • Added information regarding screen burn-in. • Added information regarding touch calibration.

Table 1: Manual history

Version	Date	Change
1.70	26-Mar-08	<ul style="list-style-type: none"> Revised vibration/shock specifications. Revised all cable descriptions. Updated information about derating the ambient temperature depending on altitude.
1.80	01-Apr-09	<ul style="list-style-type: none"> Corrected spelling and sentence structure errors. Replaced text and changed formatting: Pressing more than 2 keys at a time may result in phantom keys and trigger unintended actions in some circumstances. Added 5CASDL.0430-13 SDL flex cable with extender. Updated model numbers for replacement backlights (fluorescent tubes). Corrected error regarding replacement fluorescent tubes. Fluorescent tubes for 10.4" and 21.3" devices can only be replaced at B&R. Updated section 2.7 "Environmentally friendly disposal" on page 13 in chapter 1 "General information". Changed formatting in Table 105 "Chemical resistance of the panel overlay". Revised Figure X "Einbaulage_minus_45_Grad" and Figure X "Einbaulage_plus_45_Grad". Updated CompactFlash entry in glossary. Changed spelling of "Compact Flash" to "CompactFlash" in German documentation. Changed formatting of the phantom key notice in the technical data. Revised section 4 "B&R Key Editor" on page 143. Revised hyperlinks. Removed content of delivery for USB flash drives. Revised wording in technical data throughout the document. Revised USB interface specifications in the technical data (quantity). Updated color for display types in the technical data. Revised figures in section 2 "Replacing the fluorescent tubes" on page 190. Revised BIOS settings sections in the connection examples. Updated cable dimensions (DVI, SDL, SDL with extender). Updated content of delivery for cables (SDL flex, SDL flex with extender). Updated labels in the cables section (in images and tables).
1.90	23-Nov-09	<ul style="list-style-type: none"> Added chapter name to border in chapters 4, 5 and 6. Changed "Temperature resistance" to "Ambient temperatures" (in the technical data for individual components). Changed notation for temperature specifications. Modified informational text ("Information") regarding the panel membrane and filter glass in Appendix A. Checked and revised wording in technical data throughout the document. Updated "Touch screen type" table entry in the technical data for the Automation Panel. Revised temperature humidity diagrams (Automation Panel, USB flash drives, touch screens). Corrected dimension diagrams for SDL cables 5CASDL.xxxx-03 and 5CASDL.0xx0-13. Corrected length tolerances and weight specifications for DVI and SDL cables (see section 4 "Cables" on page 155). Changed general name 5CASDL.0x00-13 to 5CASDL.0xx0-13 (in heading and informational text). Updated section 11 "Tips for extending the service life of the display" on page 136. Updated information/footnote regarding half-brightness time (technical data tables for 5AP9xx.xxxx-xx). Updated information regarding mounting orientation in Figure X "Ambient temperature in relation to mounting orientation" on page . Revised section 4 "B&R Key Editor" on page 143 (version 2.80 changed to version 3.00).
2.00	23-Apr-10	<ul style="list-style-type: none"> Removed information about derating the ambient temperature depending on altitude after the temperature humidity diagrams. Updated information about halogen-free and fire resistance in the technical data for SDL and SDL flex cables. Updated Key Editor screenshots in appendix A. Revised Figure 106 "5AP951.1505-01 / 5AP981.1505-01 - Hardware numbers" on page 133. Updated section 2.5 "Block diagrams" on page 23. Updated USB interface covers 5AC900.1200-01, 5AC900.1200-02 and 5AC900.1200-03. Discontinued USB interface cover 5AC900.1200-00.
2.10	22-Apr-13	<ul style="list-style-type: none"> Moved section 4 "Cables" to 6 "Accessories". Updated 4 "Software". Moved B&R Key Editor to 4 "Software". Updated B&R USB flash drive in 6 "Accessories". Updated section 12 "Pixel errors" on page 136 in 3 "Installation". Changed section 5 "USB interface cover" on page 177. Updated 5 "Standards and certifications" on page 145. Removed content of delivery for display units. Modified section "Organization of safety notices" on page 14, updated descriptions for "Caution" and "Warning". Updated section "Serial number sticker" on page 26. Revised entire manual according to current formatting standards. Updated sections "Connection examples" on page 119 and "Connecting peripheral USB devices" on page 128 in 3 "Installation". Updated sections "B&R Automation Device Interface (ADI) - Control Center" on page 137, "B&R Automation Device Interface (ADI) Development Kit" on page 139 and "B&R Automation Device Interface (ADI) .NET SDK" on page 141 in 4 "Software". Updated section "Tips for extending the service life of the display" on page 136 in 3 "Installation". Updated section "Pixel errors" on page 136 in 3 "Installation".

Table 1: Manual history

Version	Date	Change
2.20	2014-09-02	<ul style="list-style-type: none"> • Updated B&R USB flash drive 5MMUSB.4096-01, see "USB flash drives" on page 179. • Corrected the pinout of the power connector in section "Automation Panel Link plug-in cards" on page 97. • Updated GOST-R certification information in the technical data. • Updated section "GOST-R" on page 146. • Updated sections "B&R Automation Device Interface (ADI) Development Kit" on page 139, "B&R Automation Device Interface (ADI) .NET SDK" on page 141 and "B&R Key Editor" on page 143. • Changed touch screen sensors from Elo to AMT, see technical data for all "Display units". • Updated section "5-wire AMT touch screen" on page 196. • Updated the AP Link card "5DLSD3.1000-00" on page 105. • Updated SDL3 cables "5CASD3.xxxx-00" on page 171.
2.21	2015-03-18	<ul style="list-style-type: none"> • Added descriptions for new display unit revisions, see technical data for "Display units" on page 27. • Updated section "Block diagrams" on page 23.

Table 1: Manual history

2 Safety guidelines

2.1 Intended use

Programmable logic controllers (PLCs), operating/monitoring devices (industrial PCs, Power Panels, Mobile Panels, etc.) and B&R uninterruptible power supplies have been designed, developed and manufactured for conventional use in industrial environments. They were not designed, developed and manufactured for any use involving serious risks or hazards that could lead to death, injury, serious physical damage or loss of any kind without the implementation of exceptionally stringent safety precautions. In particular, such risks and hazards include the use of these devices to monitor nuclear reactions in nuclear power plants, their use in flight control or flight safety systems as well as in the control of mass transportation systems, medical life support systems or weapons systems.

2.2 Protection against electrostatic discharge

Electrical components that can be damaged by electrostatic discharge (ESD) must be handled accordingly.

2.2.1 Packaging

- **Electrical components with a housing**
...do not require special ESD packaging but must be handled properly (see "Electrical components with a housing").
- **Electrical components without a housing**
...are protected by ESD-suitable packaging.

2.2.2 Guidelines for proper ESD handling

Electrical components with a housing

- Do not touch the connector contacts on connected cables.
- Do not touch the contact tips on circuit boards.

Electrical components without a housing

The following applies in addition to the points listed under "Electrical components with a housing":

- Any persons handling electrical components or devices with installed electrical components must be grounded.
- Components are only permitted to be touched on their narrow sides or front plate.
- Components should always be stored in a suitable medium (ESD packaging, conductive foam, etc.). Metallic surfaces are not suitable storage surfaces!
- Components should not be subjected to electrostatic discharge (e.g. through the use of charged plastics).
- Ensure a minimum distance of 10 cm from monitors and TV sets.
- Measuring instruments and equipment must be grounded.
- Probes on potential-free measuring instruments must be discharged on sufficiently grounded surfaces before taking measurements.

Individual components

- ESD protective measures for individual components are thoroughly integrated at B&R (conductive floors, footwear, arm bands, etc.).
- These increased ESD protective measures for individual components are not necessary for customers handling B&R products.

2.3 Policies and procedures

Electronic devices are never completely failsafe. If the programmable control system, operating/monitoring device or uninterruptible power supply fails, the user is responsible for ensuring that other connected devices, e.g. motors, are brought to a secure state.

When using programmable logic controllers or operating/monitoring devices as control systems together with a soft PLC (e.g. B&R Automation Runtime or comparable product) or slot PLC (e.g. B&R LS251 or comparable product), safety precautions relevant to industrial control systems (e.g. the provision of safety devices such as emergency stop circuits, etc.) must be observed in accordance with applicable national and international regulations. The same applies for all other devices connected to the system, such as drives.

All tasks such as the installation, commissioning and servicing of devices are only permitted to be carried out by qualified personnel. Qualified personnel are those familiar with the transport, mounting, installation, commissioning and operation of devices who also have the appropriate qualifications (e.g. IEC 60364). National accident prevention regulations must be observed.

The safety notices, connection descriptions (type plate and documentation) and limit values listed in the technical data are to be read carefully before installation and commissioning and must be observed.

2.4 Transport and storage

During transport and storage, devices must be protected against undue stress (mechanical loads, temperature, moisture, corrosive atmospheres, etc.).

2.5 Installation

- These devices are not ready for use upon delivery and must be installed and wired according to the specifications in this documentation in order for the EMC limit values to apply.
- Installation must be performed according to this documentation using suitable equipment and tools.
- Devices are only permitted to be installed by qualified personnel without voltage applied. Before installation, voltage to the control cabinet must be switched off and prevented from being switched on again.
- General safety guidelines and national accident prevention regulations must be observed.
- Electrical installation must be carried out in accordance with applicable guidelines (e.g. line cross sections, fuses, protective ground connections).

2.6 Operation

2.6.1 Protection against touching electrical parts

To operate programmable logic controllers, operating and monitoring devices, and uninterruptible power supplies, certain components must carry dangerous voltage levels. Touching one of these parts can result in a life-threatening electric shock. This could lead to death, severe injury or damage to equipment.

Before turning on the programmable logic controller, operating/monitoring devices or uninterruptible power supply, the housing must be properly grounded (PE rail). Ground connections must be established even when testing or operating operating/monitoring devices or the uninterruptible power supply for a short time!

Before turning the device on, all parts that carry voltage must be securely covered. During operation, all covers must remain closed.

2.6.2 Environmental conditions - Dust, moisture, corrosive gases

The use of operating/monitoring devices (e.g. industrial PCs, Power Panels, Mobile Panels, etc.) and uninterruptible power supplies in very dusty environments should be avoided. Dust collection on the devices can affect functionality and may prevent sufficient cooling, especially in systems with active cooling systems (fans).

The presence of corrosive gases can also lead to malfunctions. When combined with high temperature and humidity, corrosive gases – e.g. with sulfur, nitrogen and chlorine components – can induce chemical reactions that can damage electronic components very quickly. Signs of the presence of corrosive gases are blackened copper surfaces and cable ends on existing equipment.

For operation in dusty or moist conditions, correctly installed (e.g. cutout installations) operating/monitoring devices like the Automation Panel or Power Panel are protected on the front. The back of all devices must be protected from dust and moisture and cleaned at suitable intervals.

2.6.3 Viruses and dangerous programs

This system is subject to potential risk each time data is exchanged or software is installed from a data medium (e.g. diskette, CD-ROM, USB flash drive, etc.), a network connection or the Internet. The user is responsible for assessing these dangers, implementing preventive measures such as virus protection programs, firewalls, etc. and making sure that software is only obtained from trusted sources.

2.7 Environmentally friendly disposal

All B&R programmable controllers, operating/monitoring devices and uninterruptible power supplies are designed to inflict as little harm as possible on the environment.

2.7.1 Separation of materials

It is necessary to separate different materials so the device can undergo an environmentally friendly recycling process.

Component	Disposal
Programmable logic controllers Operating/Monitoring devices Uninterruptible power supply Batteries and rechargeable batteries Cables	Electronics recycling
Cardboard box / Paper packaging	Cardboard box / Paper recycling
Plastic packaging	Plastic recycling

Table 2: Environmentally friendly separation of materials

Disposal must comply with applicable legal regulations.

3 Organization of safety notices

Safety notices in this manual are organized as follows:

Safety notice	Description
Danger!	Disregarding these safety guidelines and notices can be life-threatening.
Warning!	Disregarding these safety guidelines and notices can result in severe injury or substantial damage to equipment.
Caution!	Disregarding these safety guidelines and notices can result in injury or damage to equipment.
Information:	This information is important for preventing errors.

Table 3: Description of the safety notices used in this documentation

4 Guidelines

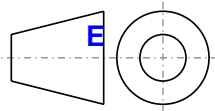

European dimension standards apply to all dimension diagrams in this document.

All dimensions are specified in mm.

Range of nominal sizes	General tolerance according to DIN ISO 2768 (medium)
Up to 6 mm	±0.1 mm
For 6 to 30 mm	±0.2 mm
For 30 to 120 mm	±0.3 mm
For 120 to 400 mm	±0.5 mm
For 400 to 1000 mm	±0.8 mm

Table 4: Range of nominal sizes

5 Overview

Product ID	Short description	on page
Accessories		
5AC804.MFLT-00	Line filter	184
5AC900.104X-03	Legend Strips Template 10,4" for Automation Panel 5AP951.1043-01 and 5AP981.1043-01; for 1 device.	154
5AC900.104X-04	Legend Strips Template 10,4" for Automation Panel 5AP952.1043-01 and 5AP982.1043-01; for 1 device.	154
5AC900.104X-05	Legend Strips Template 10,4" for Automation Panel 5AP980.1043-01; for 3 devices.	154
5AC900.1200-00	USB Cover non-detachable; for Automation Panel and Panel PC.	177
5AC900.1200-01	USB interface cover - Flat - For AP920/98x and PPC700	177
5AC900.1201-00	USB interface cover M20 IP65 flat	177
5AC900.1201-01	USB interface cover M20 IP65 curved	178
5AC900.150X-01	Legend Strips Template 15,0" for Automation Panel 5AP951.1505-01, 5AP980.1505-01 and 5AP981.1505-01 and Panel PC 5PC781.1505-00; for 4 devices.	154
9A0110.18	Backlight (spare part) for panels with Sharp LQ121S1DG41: 5AP920.1214-01 5PC720.1214-00 5PC720.1214-01 5PP120.1214-37 5PP120.1214-37A 5PP320.1214-39	183
9A0110.22	Backlight (spare part) for panels with Sharp LQ150X1LW71N: 4PP120.1505-31 From revision S0 4PP151.1505-31 From revision H0 4PP180.1505-31 From revision I0 4PP181.1505-31 From revision H0 4PP220.1505-75 From revision V0 4PP220.1505-B5 From revision W0 4PP251.1505-75 From revision I0 4PP251.1505-B5 From revision I0 4PP280.1505-75 From revision I0 4PP280.1505-B5 From revision I0 4PP281.1505-75 From revision I0 4PP281.1505-B5 From revision I0 4PP320.1505-31 From revision A0 4PP420.1505-75 From revision A0 4PP420.1505-B5 From revision A0 4PP480.1505-75 From revision A0 4PP480.1505-B5 From revision A0 4PP481.1505-75 From revision A0 5AP820.1505-00 From revision A0 5AP880.1505-00 From revision A0 5AP920.1505-01 From revision A0 5AP951.1505-01 From revision A0 5AP980.1505-01 From revision A0 5AP981.1505-01 From revision A0 5PC720.1505-00 From revision A0 5PC720.1505-01 From revision A0 5PC720.1505-02 From revision A0 5PC781.1505-00 From revision A0 5PP120.1505-37A From revision H0 5PP320.1505-39 From revision A0	183
DVI cables		
5CADVI.0018-00	DVI-D cable - 1.8 m	155
5CADVI.0050-00	DVI-D cable - 5 m	155
5CADVI.0100-00	DVI-D cable - 10 m	155
Display Links		
5DLDMI.1000-01	Automation Panel Link DVI receiver; connections for DVI-D, RS232 and USB 2.0 (Type B); 24 VDC (order screw clamp OTB103.9 or cage clamp OTB103.91 separately).	146
5DLSL.1000-01	Automation Panel Link SDL receiver; connection for SDL In; transmission of display, touch screen, USB 1.1, matrix key and service data; 24 VDC (order screw clamp OTB103.9 or cage clamp OTB103.91 separately).	146
Display links		
5DLSL3.1000-00	Automation Panel Link SDL3 receiver - For Automation Panel 920/98x	105
5DLSL.1000-00	Automation Panel Link SDL receiver; connection for SDL In; transmission of display, touch screen, USB 1.1, matrix key and service data; 24 VDC (order screw clamp OTB103.9 or cage clamp OTB103.91 separately).	101
Display units		
5AP920.1043-01	Automation Panel AP920 10.4" TFT - 640 x 480 pixels (4:3) - Single-touch (analog resistive) - Landscape format - IP65 protection (front)	28
5AP920.1214-01	Automation Panel AP920 12.1" TFT - 800 x 600 pixels (4:3) - Single-touch (analog resistive) - Landscape format - IP65 protection (front)	57
5AP920.1706-01	Automation Panel AP920 17" SXGA color TFT display with touch screen (resistive); 3 USB 2.0 interfaces; slot for Automation Panel link; IP65 protection (from front). 24 VDC.	83
5AP920.2138-01	Automation Panel AP920 21.3" UXGA color TFT display with touch screen (resistive); 3 USB 2.0 interfaces; insert for Automation Panel Link; IP65 protection (front). 24VDC.	93
5AP951.1043-01	Automation Panel AP951 10.4" VGA color TFT display; 10 softkeys; 28 function keys and 20 system keys; 2 USB 2.0 interfaces; slot for Automation Panel link; IP 65 protection (from front). 24 VDC.	32
5AP951.1505-01	Automation Panel AP951 15" XGA color TFT display with; 12 softkeys; 20 function keys and 92 system keys; 3 USB 2.0 interfaces; slot for Automation Panel link; IP 65 protection (front side). 24 VDC.	67
5AP952.1043-01	Automation Panel AP952 10.4" VGA color TFT display; 44 function keys and 20 system keys; 2 USB 2.0 interfaces; slot for Automation Panel link; IP 65 protection (from front). 24 VDC.	37
5AP980.1043-01	Automation Panel AP980, 10.4" VGA color TFT display with touch screen (resistive); 10 soft keys and 12 function keys; 2 USB 2.0 interfaces; insert for Automation Panel Link; IP65 protection (front). 24 VDC.	42
5AP980.1505-01	Automation Panel AP980, 15" XGA color TFT display with touch screen (resistive); 12 soft keys and 20 function keys; 3 USB 2.0 interfaces; insert for Automation Panel Link; IP65 protection (front). 24 VDC.	72
5AP981.1043-01	Automation Panel AP981; 10.4" VGA color TFT display with touch screen (resistive); 10 soft keys; 28 function keys and 20 system keys; 2 USB 2.0 interfaces; insert for Automation Panel Link; IP65 protection (front). 24 VDC.	48
5AP981.1505-01	Automation Panel AP981; 15" XGA color TFT display with touch screen (resistive); 12 soft keys; 20 function keys and 92 system keys; 3 USB 2.0 interfaces; insert for Automation Panel Link; IP65 protection (front). 24 VDC.	78
5AP982.1043-01	Automation Panel AP982; 10.4" VGA color TFT screen (resistive); 44 function keys and 20 system keys; 2 USB 2.0 interfaces; insert for Automation Panel Link; IP65 protection (from front). 24 VDC.	52
Displayeinheiten		
5AP920.1505-01	Automation Panel AP920; 15" XGA color TFT display with touch screen (resistive); 3 USB 2.0 interfaces; insert for Automation Panel Link; IP65 protection (from front). 24 VDC.	146
5AP920.1906-01	Automation Panel AP920; 19" SXGA color TFT display with touch screen (resistive); 3 USB 2.0 interfaces; insert for Automation Panel Link; IP65 protection (from front). 24 VDC.	146
Other		
5SWHMI.0000-00	HMI Drivers & Utilities DVD	186
RS232 cables		
9A0014.02	RS232 extension cable for remote operation of a display unit with touch screen, 1.8 m	175
9A0014.05	RS232 extension cable for remote operation of a display unit with touch screen, 5 m	175
9A0014.10	RS232 extension cable for remote operation of a display unit with touch screen, 10 m	175
SDL cables		
5CASDL.0018-00	SDL cable - 1.8 m	158

Product ID	Short description	on page
5CASDL.0050-00	SDL cable - 5 m.	158
5CASDL.0100-00	SDL cable, 10 m	158
5CASDL.0150-00	SDL cable, 15 m	158
5CASDL.0200-00	SDL cable, 20 m	158
5CASDL.0250-00	SDL cable, 25 m	158
5CASDL.0300-00	SDL cable, 30 m	158
SDL cables with 45° connectors		
5CASDL.0018-01	SDL cable - 45° connector - 1.8 m	161
5CASDL.0050-01	SDL cable with 45° male connector, 5 m	161
5CASDL.0100-01	SDL cable with 45° male connector, 10 m	161
5CASDL.0150-01	SDL cable with 45° male connector, 15 m	161
SDL flex cables		
5CASDL.0018-03	SDL flex cable - 1.8 m	164
5CASDL.0050-03	SDL flex cable, 5 m	164
5CASDL.0100-03	SDL flex cable, 10 m	164
5CASDL.0150-03	SDL flex cable, 15 m	164
5CASDL.0200-03	SDL flex cable, 20 m	164
5CASDL.0250-03	SDL flex cable, 25 m	164
5CASDL.0300-03	SDL flex cable, 30 m	164
5CASDL.0300-13	SDL flex cable with extender, 30 m	167
5CASDL.0400-13	SDL flex cable with extender, 40 m	167
5CASDL.0430-13	SDL flex cable with extender, 43 m	167
SDL3 cable		
5CASD3.0100-00	SDL3 cable, 10 m	171
5CASD3.0150-00	SDL3 cable, 15 m	171
5CASD3.0200-00	SDL3 cable, 20 m	171
5CASD3.0300-00	SDL3 cable, 30 m	171
5CASD3.0500-00	SDL3 cable, 50 m	171
5CASD3.1000-00	SDL3 cable, 100 m	171
Terminal blocks		
0TB103.8	Connector, 24 VDC, 3-pin male, screw clamp, 3.31 mm ² , protected against vibration by the screw flange	153
0TB103.9	Connector 24 VDC - 3-pin female - Screw clamps 3.31 mm ²	151
0TB103.91	Connector 24 VDC - 3-pin female - Cage clamps 3.31 mm ²	151
USB accessories		
5MMUSB.2048-00	USB 2.0 flash drive, 2048 MB	179
5MMUSB.2048-01	USB 2.0 flash drive, 2048 MB, B&R	181
5MMUSB.4096-01	USB 2.0 flash drive, 4096 MB, B&R	181
USB cables		
5CAUSB.0018-00	USB 2.0 connection cable type A - type B, 1.8 m	174
5CAUSB.0050-00	USB 2.0 connection cable type A - type B, 5 m	174

Chapter 2 • Technical data

1 Introduction

The Automation Panel series is a generation of B&R display units ranging from 10.4" to 19" that breaks new ground when it comes to the modularity of interfaces to PC systems. As a result, the transfer of image data is independent of the display unit. This allows future innovations in the area of transfer technology to be implemented using a new Automation Panel Link.



2 Complete system

Display units consist of two components: an Automation Panel and an Automation Panel Link plug-in card. Combined, these two components make up the complete display unit.

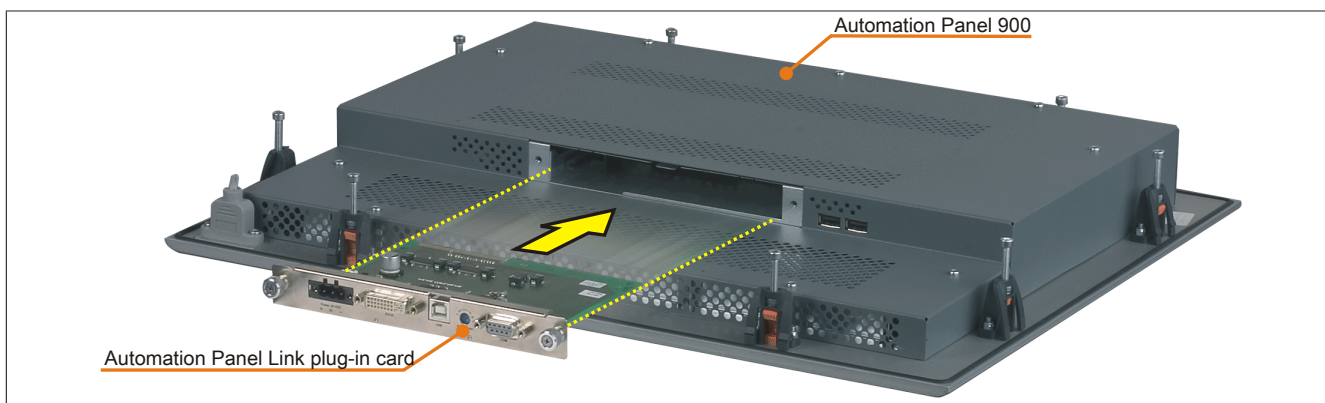

Figure 1: Automation Panel and Automation Panel Link plug-in card

Each device has at least one USB interface on the front and back so that data can be easily exchanged with an industrial PC (e.g. using a USB flash drive).

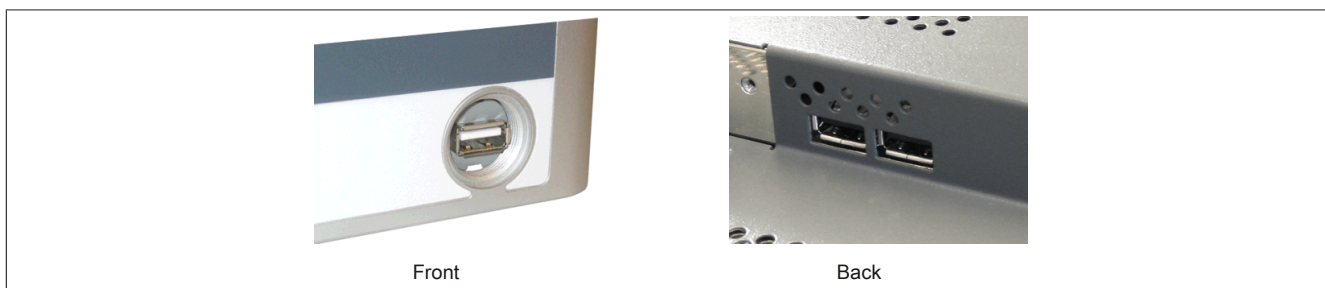

Figure 2: USB interfaces on the Automation Panel (front and back)

2.2 Temperature specifications

2.2.1 Maximum ambient temperature

The following table lists the specifications for minimum and maximum ambient temperature for all available Automation Panel 900 variants during operation in relation to mounting orientation (for specifications, see "Mounting orientation" on page 111).

Automation Panel 900 without Rittal housing

		Automation Panel Link											
		DVI receiver			SDL receiver			SDL transmitter			SDL3 receiver		
		5DL DVI.1000-01			5DLSDL.1000-00			5DLSDL.1000-01			5DLSDL3.1000-00		
All temperature values in degrees Celsius (°C) at 500 m above sea level.													
The maximum ambient temperature is typically derated by 1°C per 1000 meters (starting at 500 meters above sea level).													
Maximum ambient temperature		55	55	55	55	55	55	55	55	55	50	50	50
mounting orientation		0°	-45° ¹⁾	+45° ²⁾	0°	-45° ¹⁾	+45° ²⁾	0°	-45° ¹⁾	+45° ²⁾	0°	-45° ¹⁾	+45° ²⁾
What else can also be operated at the max. ambient temperature, or are there any limits?													
Display units	5AP920.1043-01	50	50	50	50	50	50	50	50	50	-	-	-
	5AP951.1043-01	✓	✓	✓	✓	✓	✓	✓	✓	✓	-	-	-
	5AP952.1043-01	✓	✓	✓	✓	✓	✓	✓	✓	✓	-	-	-
	5AP980.1043-01	50	50	50	50	50	50	50	50	50	✓	✓	✓
	5AP981.1043-01	50	50	50	50	50	50	50	50	50	✓	✓	✓
	5AP982.1043-01	50	50	50	50	50	50	50	50	50	✓	✓	✓
	5AP920.1214-01	50	50	50	50	50	50	50	50	50	✓	✓	✓
	5AP920.1505-01	50	50	45	50	50	45	50	50	45	✓	✓	45
	5AP951.1505-01	50	50	45	50	50	45	50	50	45	-	-	-
	5AP980.1505-01	50	50	45	50	50	45	50	50	45	✓	✓	45
	5AP981.1505-01	50	50	45	50	50	45	50	50	45	✓	✓	45
	5AP920.1706-01	40	45	35	40	45	35	40	45	35	-	-	-
5AP920.1906-01	40	40	40	40	40	40	40	40	40	40	40	40	
5AP920.2138-01	35	35	30	35	35	30	35	35	30	-	-	-	

1) -45°: Display, top
2) +45°: Display, bottom

Table 5: Ambient temperature - AP900 without Rittal housing

Automation Panel 900 with Rittal housing

		Automation Panel Link											
		DVI receiver			SDL receiver			SDL transmitter			SDL3 receiver		
		5DL DVI.1000-01			5DLSDL.1000-00			5DLSDL.1000-01			5DLSDL3.1000-00		
All temperature values in degrees Celsius (°C) at 500 m above sea level.													
The maximum ambient temperature is typically derated by 1°C per 1000 meters (starting at 500 meters above sea level).													
Maximum ambient temperature		50	45	45	50	45	45	50	45	45	45	40	40
mounting orientation		0°	-45° ¹⁾	+45° ²⁾	0°	-45° ¹⁾	+45° ²⁾	0°	-45° ¹⁾	+45° ²⁾	0°	-45° ¹⁾	+45° ²⁾
What else can also be operated at the max. ambient temperature, or are there any limits?													
Display units	5AP920.1043-01	✓	✓	✓	✓	✓	✓	✓	✓	✓	-	-	-
	5AP951.1043-01	✓	✓	✓	✓	✓	✓	✓	✓	✓	-	-	-
	5AP952.1043-01	✓	✓	✓	✓	✓	✓	✓	✓	✓	-	-	-
	5AP980.1043-01	✓	✓	✓	✓	✓	✓	✓	✓	✓	✓	✓	✓
	5AP981.1043-01	✓	✓	✓	✓	✓	✓	✓	✓	✓	✓	✓	✓
	5AP982.1043-01	✓	✓	✓	✓	✓	✓	✓	✓	✓	✓	✓	✓
	5AP920.1505-01	40	40	40	40	40	40	40	40	40	40	✓	✓
	5AP951.1505-01	40	40	40	40	40	40	40	40	40	-	-	-
	5AP980.1505-01	40	40	40	40	40	40	40	40	40	40	✓	✓
	5AP981.1505-01	40	40	40	40	40	40	40	40	40	40	✓	✓

1) -45°: Display, top
2) +45°: Display, bottom

Table 6: Ambient temperature - AP900 with Rittal housing

2.2.2 Minimum ambient temperature during operation

The minimum ambient temperature during operation is 0°C.

2.3 Humidity specifications

The following table lists the minimum and maximum relative humidity values for the individual components that are relevant for the humidity limitations of a complete system. The lowest and highest common values are always used when establishing these limits.

Component	Operation	Storage / Transport
5AP920.1043-01	5 to 90%	5 to 90%
5AP951.1043-01	5 to 95%	5 to 95%
5AP952.1043-01	5 to 95%	5 to 95%
5AP980.1043-01	5 to 90%	5 to 90%
5AP981.1043-01	5 to 90%	5 to 90%
5AP982.1043-01	5 to 90%	5 to 90%
5AP920.1214-01	5 to 90%	5 to 90%
5AP920.1505-01	5 to 90%	5 to 90%
5AP951.1505-01	5 to 95%	5 to 95%
5AP980.1505-01	5 to 90%	5 to 90%
5AP981.1505-01	5 to 90%	5 to 90%
5AP920.1706-01	20 to 90%	5 to 90%
5AP920.1906-01	20 to 90%	5 to 90%
5AP920.2138-01	20 to 90%	5 to 90%
5DL DVI.1000-01	5 to 95%	5 to 95%
5DLSDL.1000-00	5 to 95%	5 to 95%
5DLSDL.1000-01	5 to 95%	5 to 95%
5DLSD3.1000-00	5 to 95%	5 to 95%

Table 7: Overview of humidity specifications for individual components

The specifications listed correspond to the relative humidity at an ambient temperature of 30°C. More detailed information about specific temperature-dependent humidity values can be found in the technical data for the individual components.

2.4 Power consumption

Total consumption is made up of the consumption of the Automation Panel 900 device as well as the power used by Automation Panel Link insert card.

The following table lists the typical consumption for each component. The sum of both equals the total consumption. Both values can also be found in the "Technical data" section for the individual components.

Component	Typical	Maximum	Maximum with USB
5AP920.1043-01	10 W	13 W	19 W
5AP951.1043-01	10 W	14 W	20 W
5AP952.1043-01	10 W	14 W	21 W
5AP980.1043-01	10 W	13 W	20 W
5AP981.1043-01	10 W	14 W	21 W
5AP982.1043-01	10 W	14 W	21 W
5AP920.1214-01	12 W	15 W	21 W
5AP920.1505-01	24 W	31 W	41 W
5AP951.1505-01	24 W	32 W	42 W
5AP980.1505-01	24 W	32 W	42 W
5AP981.1505-01	24 W	32 W	42 W
5AP920.1706-01	27 W	36 W	46 W
5AP920.1906-01	27 W	38 W	48 W
5AP920.2138-01	50 W	63 W	73 W
5DLDVI.1000-01	3 W	3 W	3 W
5DLSDL.1000-00	3 W	3 W	3 W
5DLSDL.1000-01	3 W	3 W	3 W
5DLSD3.1000-00	6 W	6 W	9 W
Total			

Table 8: Power management according to mounting orientation

Specifications for the starting current can be found in the "Technical data" for each Automation Panel 900 variant.

2.5 Block diagrams

2.5.1 AP900 block diagram

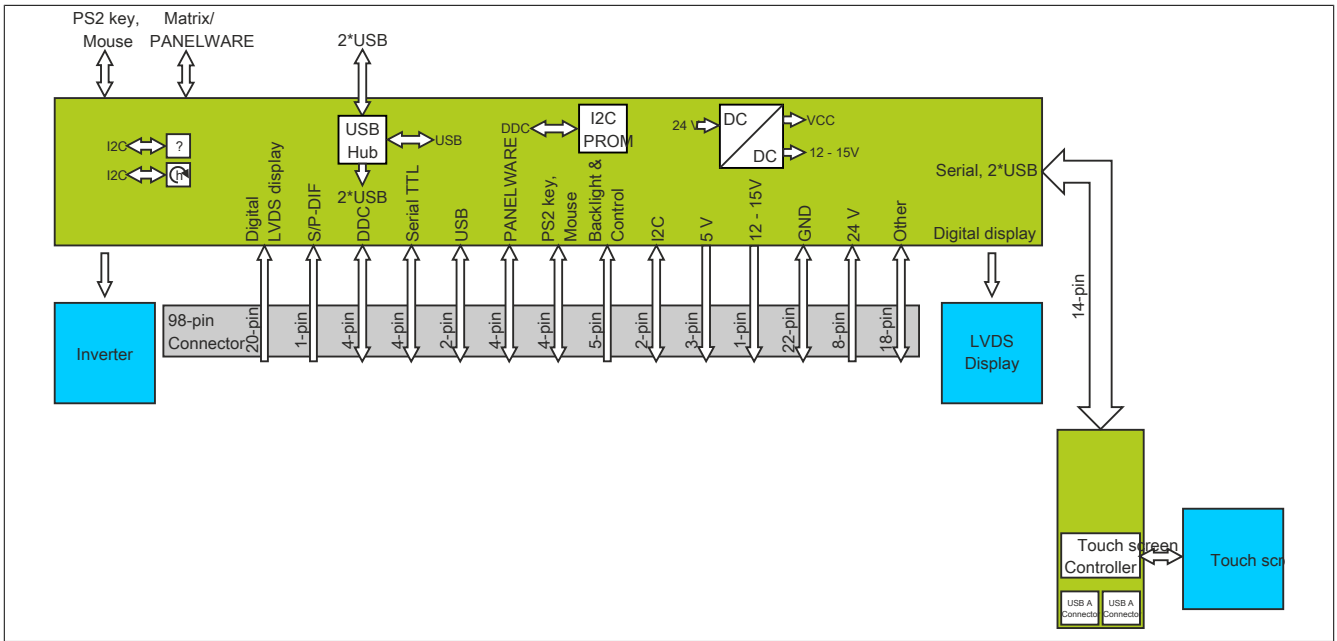

Figure 3: AP900 block diagram

2.5.2 AP900 block diagram with DVI Link

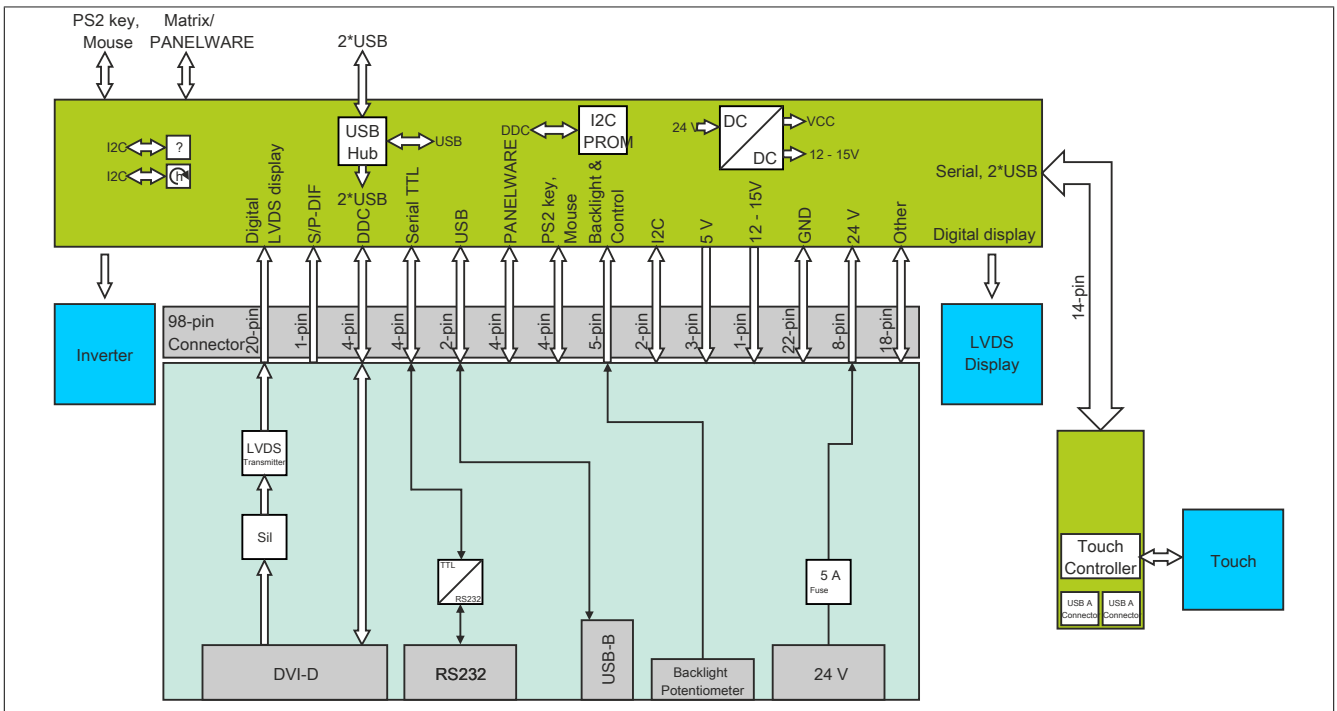

Figure 4: AP900 block diagram with DVI Link

2.5.3 AP900 with SDL receiver - Block diagram

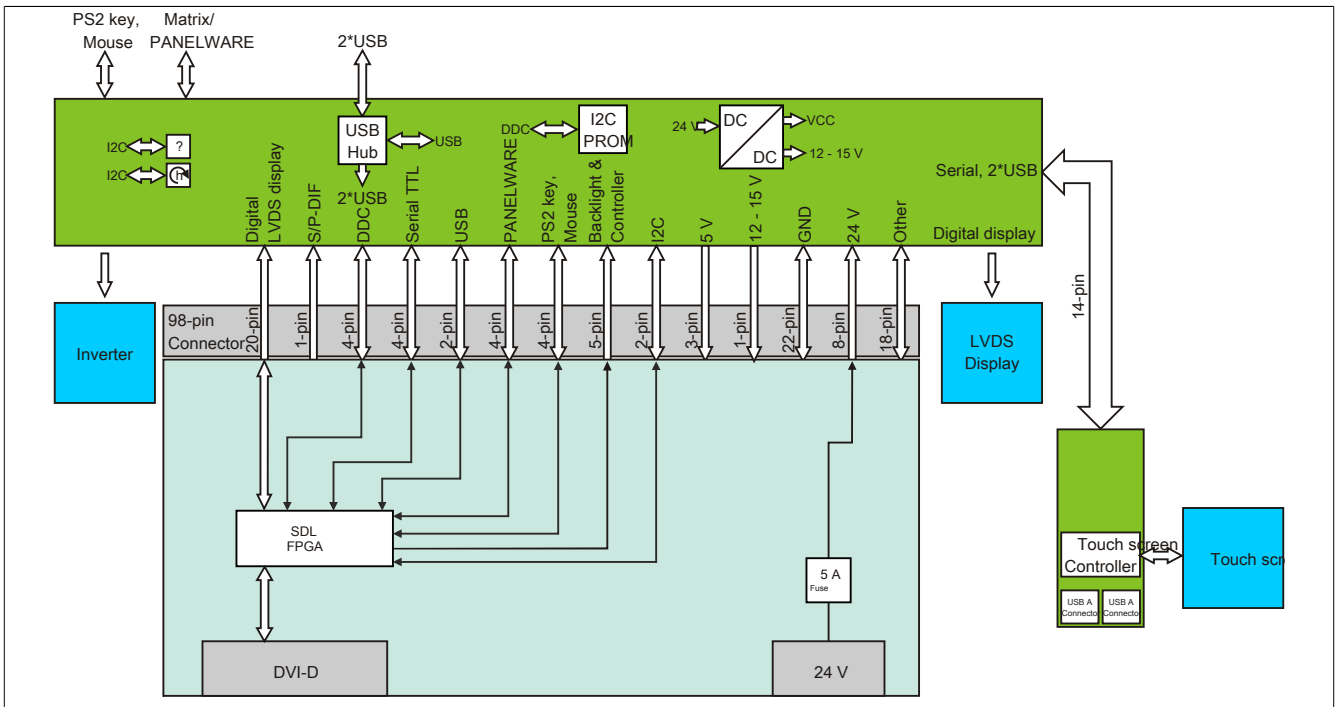

Figure 5: AP900 with SDL receiver - Block diagram

2.5.4 AP900 with SDL transceiver - Block diagram

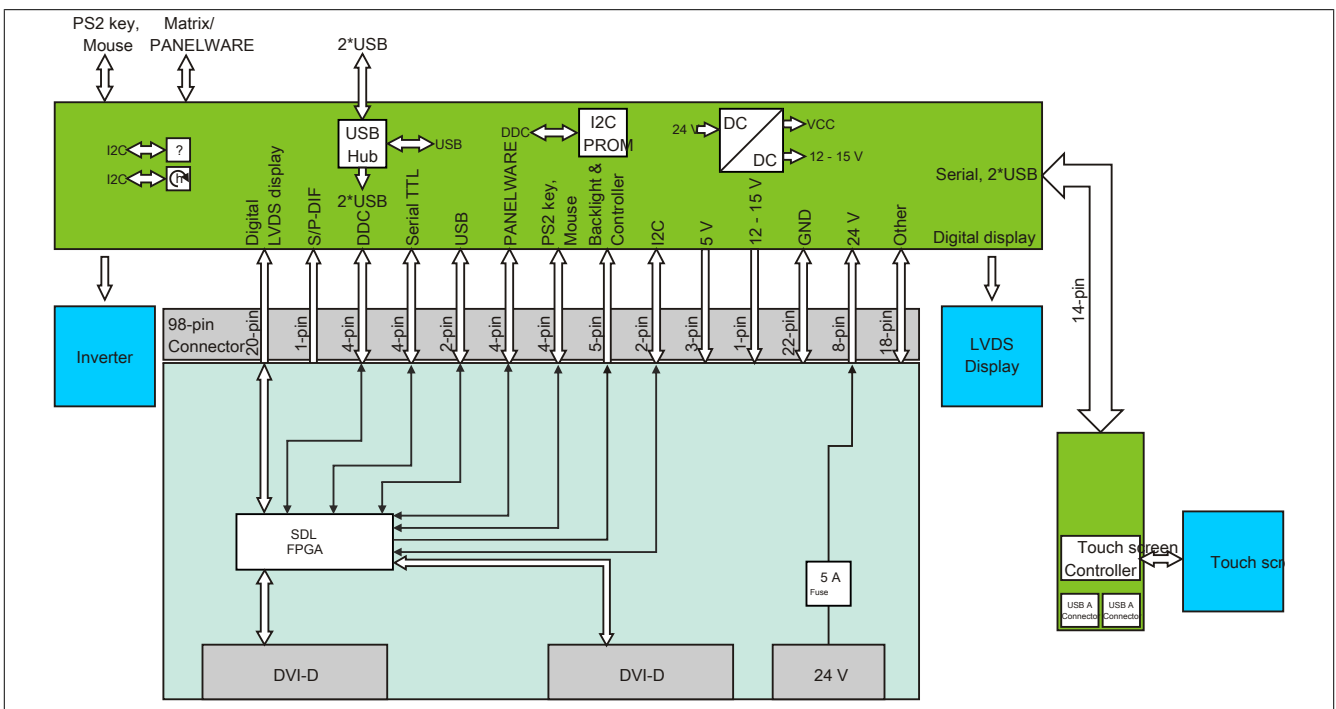

Figure 6: AP900 with SDL transceiver - Block diagram

2.5.5 AP900 with SDL3 receiver - Block diagram

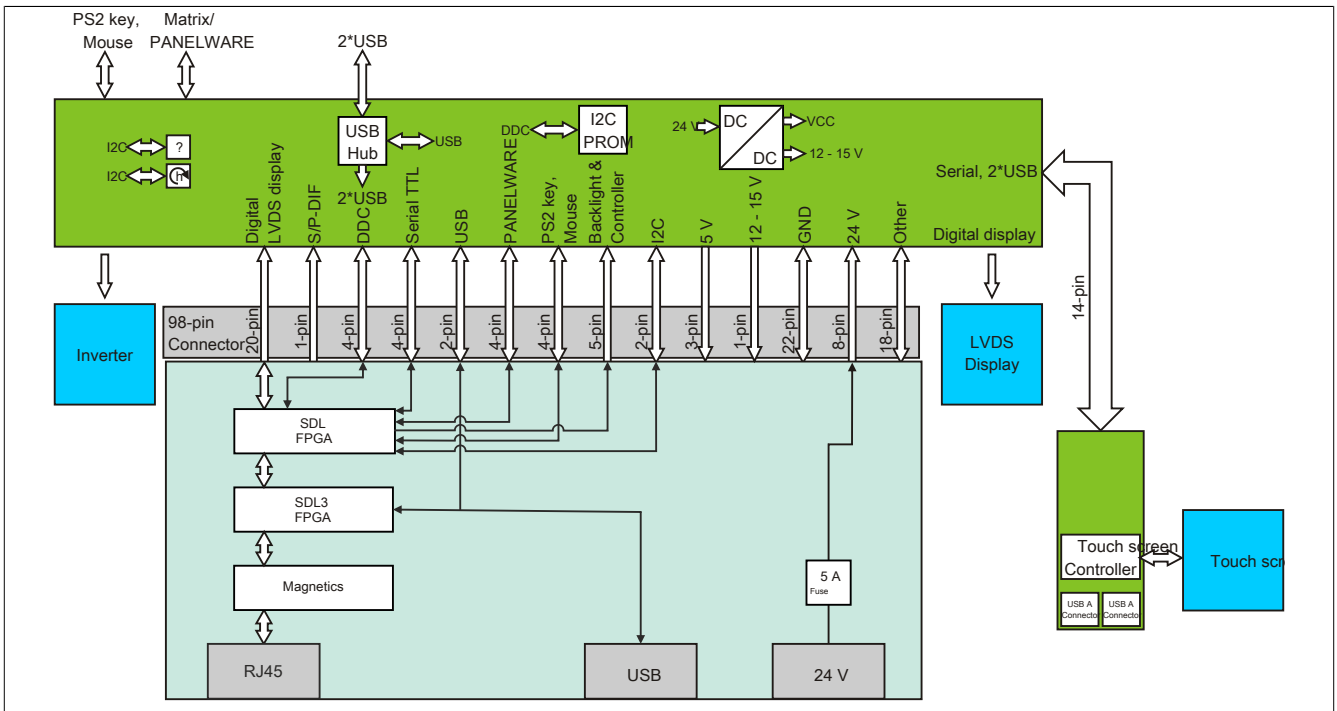

Figure 7: AP900 with SDL3 receiver - Block diagram

2.6 Serial number sticker

A unique serial number sticker with a barcode (Code 128) is affixed to each B&R device for identification purposes. This serial number represents all of the individual components built into the system (model number, name, revision, serial number, delivery date and duration of warranty).

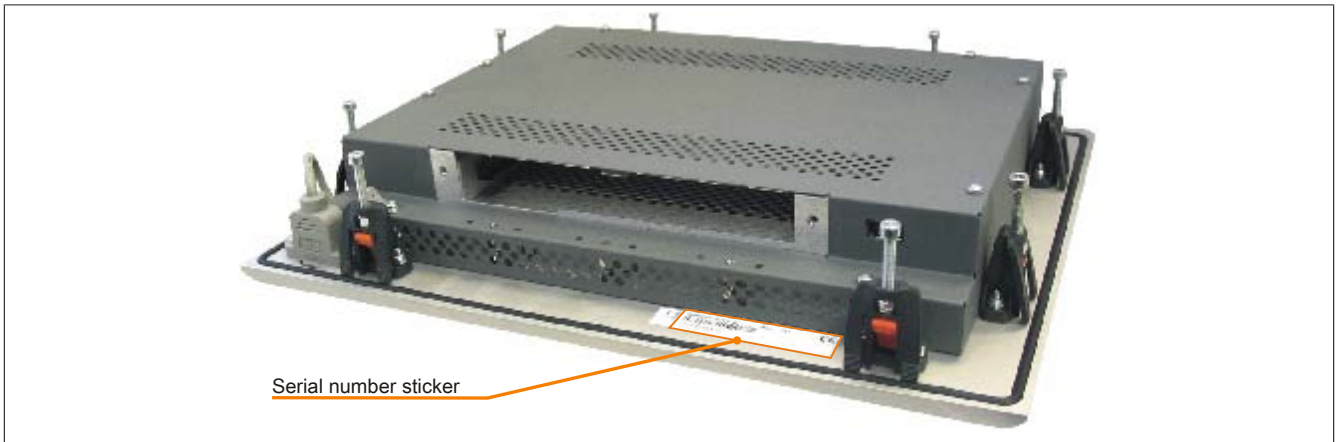

Figure 8: Serial number sticker (back)

This information can also be found on the B&R website by entering the serial number of the complete system in the search field tab (after selecting the "Serial number" option) at the top of the website (www.br-automation.com). The search provides a detailed list of installed components.

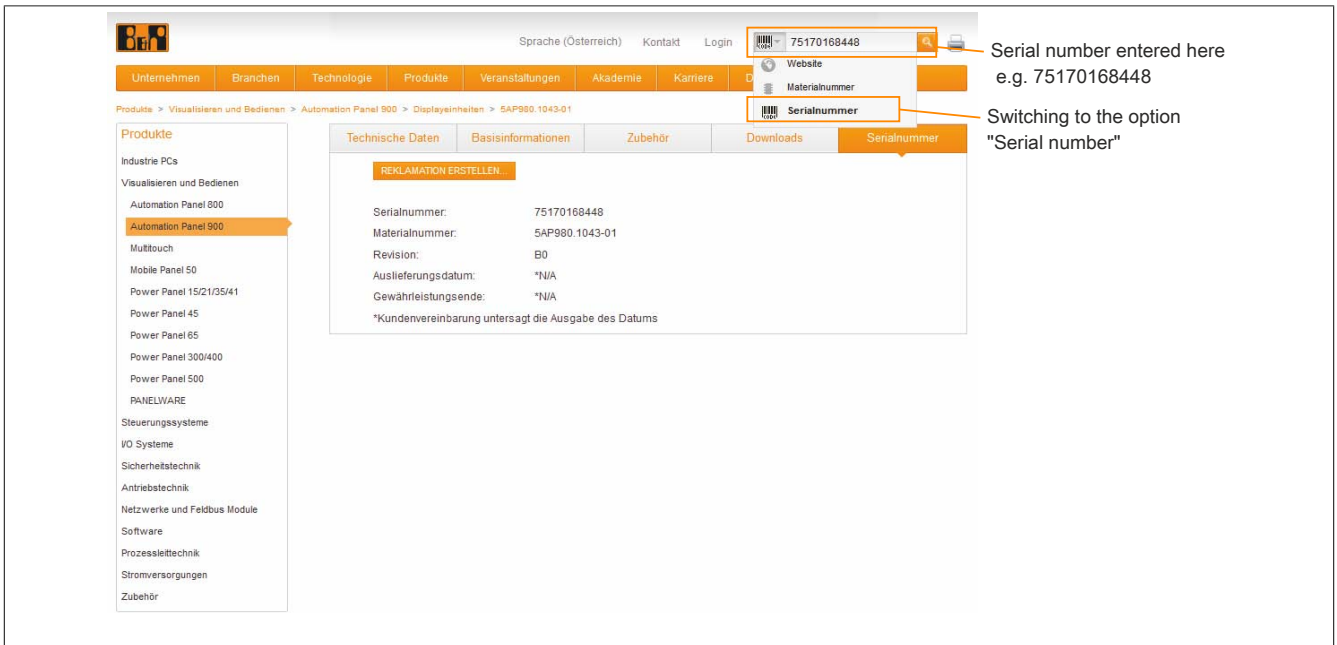

Figure 9: Example of serial number search

3 Individual components

3.1 Display units

3.1.1 Automation Panel 10.4" VGA

3.1.1.1 5AP920.1043-01

3.1.1.1.1 General information

- 10.4" VGA color TFT display
- Analog resistive touch screen
- Small installation depth
- Fan-free operation
- Can be upgraded with Display Link cards or PPC300

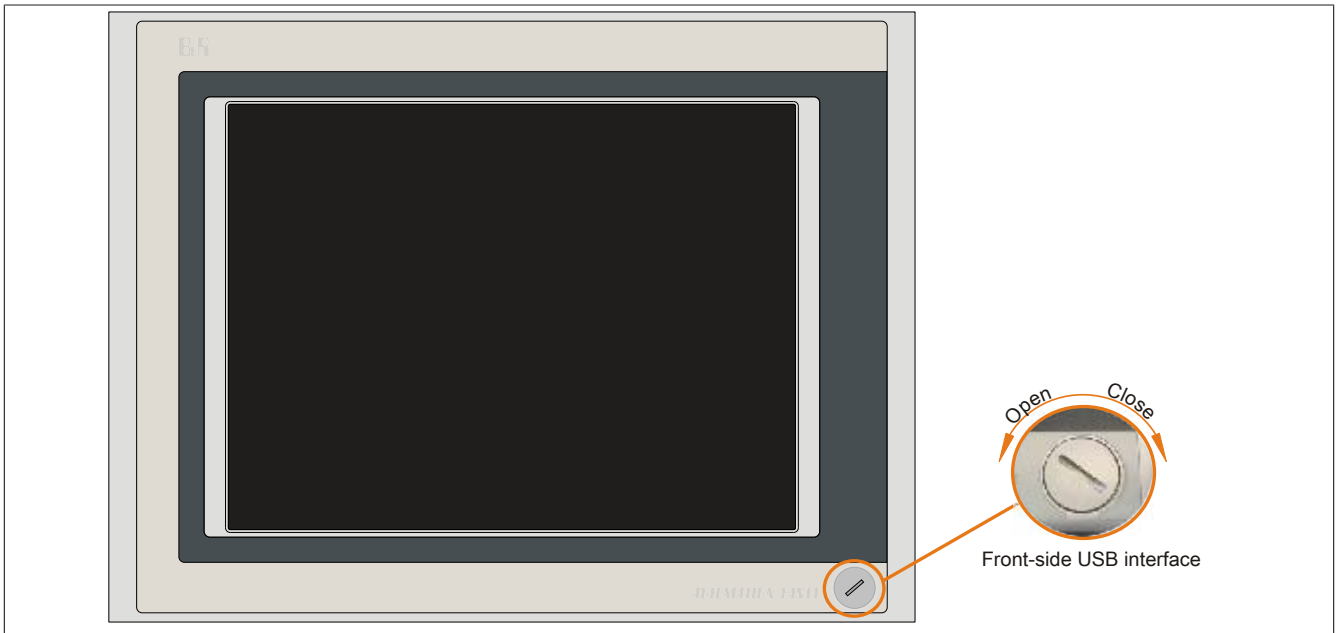

Figure 10: 5AP920.1043-01 - Front view

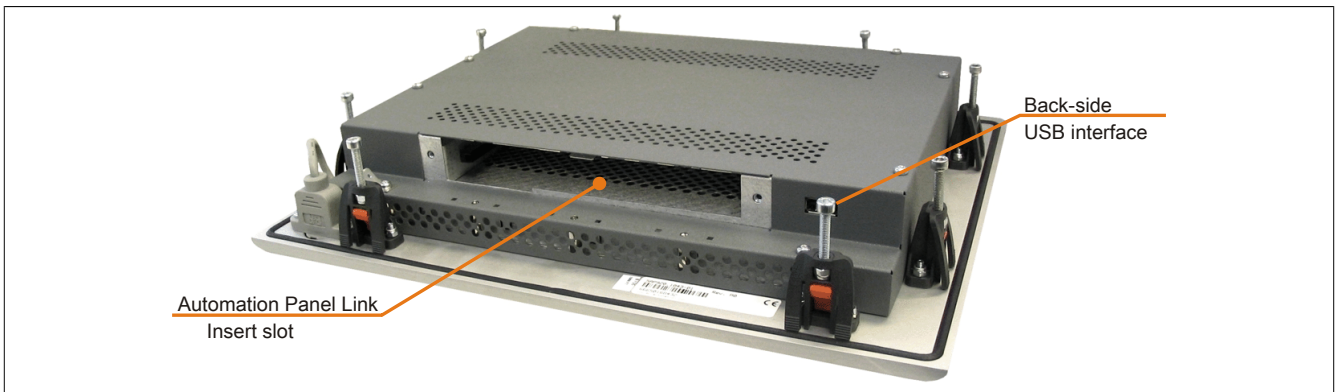

Figure 11: 5AP920.1043-01 - Rear view

3.1.1.1.2 Order data

Model number	Short description	Figure
	Display units	
5AP920.1043-01	Automation Panel AP920 10.4" TFT - 640 x 480 pixels (4:3) - Single-touch (analog resistive) - Landscape format - IP65 protection (front)	
	Required accessories	
	Display links	
5DLDVI.1000-01	Automation Panel Link DVI receiver; connections for DVI-D, RS232 and USB 2.0 (Type B); 24 VDC (order screw clamp 0TB103.9 or cage clamp 0TB103.91 separately).	
5DLSDL.1000-00	Automation Panel Link SDL receiver; connection for SDL In; transmission of display, touch screen, USB 1.1, matrix key and service data; 24 VDC (order screw clamp 0TB103.9 or cage clamp 0TB103.91 separately).	
5DLSDL.1000-01	Automation Panel Link SDL transceiver; connections for SDL In and SDL Out; transmission of display, touch screen, USB 1.1, matrix key and service data; 24 VDC (order screw clamp 0TB103.9 or cage clamp 0TB103.91 separately).	
	Terminal blocks	
0TB103.9	Connector 24 VDC - 3-pin female - Screw clamps 3.31 mm ²	
0TB103.91	Connector 24 VDC - 3-pin female - Cage clamps 3.31 mm ²	
	Optional accessories	
	Panel PC 300 insert cards	
5PC310.L800-00	Panel PC 300 insert card for the Automation Panel 900; 256 MB SDRAM; CompactFlash slot (Type I); 2x ETH 10/100; RS232; USB 2.0 (via integrated USB 2.0 interfaces on the Automation Panel); battery; 24 VDC (order screw clamp 0TB103.9 or cage clamp 0TB103.91 separately)	
5PC310.L800-01	Panel PC 300 insert card for the Automation Panel 900; 512 MB SDRAM; CompactFlash slot (Type I); 2x ETH 10/100; RS232; USB 2.0 (via integrated USB 2.0 interfaces on the Automation Panel); battery; 24 VDC (order screw clamp 0TB103.9 or cage clamp 0TB103.91 separately)	

Table 9: 5AP920.1043-01 - Order data

3.1.1.1.3 Technical data

Product ID	5AP920.1043-01			
Revision	C0	D0	H0	J0
General information				
B&R ID code	0x1A09			
Certification				
CE	Yes			
cULus	Yes			
GOST-R	Yes			
Interfaces				
USB ¹⁾				
Quantity	2			
Type	USB 2.0 ²⁾			
Execution	Type A			
Transfer rate	Low speed (1.5 Mbit/s), full speed (12 Mbit/s), high speed (480 Mbit/s)			
Current load	Max. 500 mA per connection			
Display				
Type	TFT color			
Display size	10.4" (264 mm)			
Colors	262144			16 million
Resolution	VGA, 640 x 480 pixels			
Contrast	300:1			700:1
Viewing angles				
Horizontal	Direction R = 70° / Direction L = 70°			Direction R = 80° / Direction L = 80°
Vertical	Direction U = 40° / Direction D = 70°			Direction U = 80° / Direction D = 60°
Backlight				
Type	CCFL			LED
Brightness	350 cd/m ²			450 cd/m ²
Half-brightness time ³⁾	50,000 h			
Filter glass				
Transmittance	-			
Coating	-			

Table 10: 5AP920.1043-01, 5AP920.1043-01, 5AP920.1043-01, 5AP920.1043-01 - Technical data

Product ID		5AP920.1043-01	
Touch screen ⁴⁾			
Type	Elo AccuTouch		AMT
Technology		Analog, resistive	
Controller		Elo, serial, 12-bit	
Transmittance	80% ±5%		81% ±3%
Keys			
Function keys		No	
Soft keys		No	
System keys		No	
Service life		-	
LED brightness		-	
LED brightness Yellow		-	
Inserts			
Compatible installation for PPC300 insert	No		Yes
Electrical characteristics			
Nominal voltage		24 VDC ±25%	
Nominal current		Max. 3.2 A ⁵⁾	
Starting current		Typ. 6 A, max. 30 A for <300 µs	
Power consumption		Typ. 10 W, max. 13 W or 19 W with USB (without insert)	
Electrical isolation		Yes	
Operating conditions			
EN 60529 protection		Back: IP20 (only with an inserted Automation Panel Link card) Front: IP65 / NEMA 250 type 4X indoor, dust and sprayed water protection	
Environmental conditions			
Temperature Operation		Without Rittal housing Mounting orientation 0°: 0 to 50°C Mounting orientations to -45° display above: 0 to 50°C Mounting orientations to +45° display below: 0 to 50°C With Rittal housing Mounting orientation 0°: 0 to 50°C Mounting orientations to -45° display above: 0 to 45°C Mounting orientations to +45° display below: 0 to 45°C	
Storage Transport		-30 to 70°C	
Vibration Operation (continuous) Operation (occasional) Storage Transport		2 to 9 Hz: 1.75 mm amplitude / 9 to 200 Hz: 0.5 g 2 to 9 Hz: 3.5 mm amplitude / 9 to 200 Hz: 1 g 2 to 8 Hz: 7.5 mm amplitude / 8 to 200 Hz: 2 g / 200 to 500 Hz: 4 g 2 to 8 Hz: 7.5 mm amplitude / 8 to 200 Hz: 2 g / 200 to 500 Hz: 4 g	
Shock Operation Storage Transport		15 g, 11 ms 30 g, 15 ms 30 g, 15 ms	
Altitude Operation		Max. 3000 m ⁶⁾	
Mechanical characteristics			
Housing Material Paint		Metal Similar to Pantone 432CV	
Front ⁷⁾ Frame Design Panel overlay Material Light background Dark gray border around display Gasket		Naturally anodized aluminum Gray Polyester Similar to Pantone 427CV Similar to Pantone 432CV Flat gasket around display front	
Dimensions Width Height Depth		323 mm 260 mm 55 mm	
Weight		Approx. 2900 g	

Table 10: 5AP920.1043-01, 5AP920.1043-01, 5AP920.1043-01, 5AP920.1043-01 - Technical data

- 1) USB devices can only be connected to the Automation Panel directly (i.e. without a hub).
- 2) Depends on the transmission technology, the transfer distance and the Automation Panel Link insert card being used.
- 3) At an ambient temperature of 25°C. Reducing the brightness by 50% can result in an approximately 50% increase in the half-brightness time.
- 4) Touch screen drivers for approved operating systems are available in the Downloads section of the B&R website.
- 5) The specified value applies to Automation Panel systems with an inserted Automation Panel Link card.
- 6) The maximum ambient temperature is typically derated by 1°C per 1000 meters (starting at 500 meters above sea level).
- 7) There may be visible deviations in the color and surface appearance depending on the process or batch.

3.1.1.1.4 Temperature humidity diagram

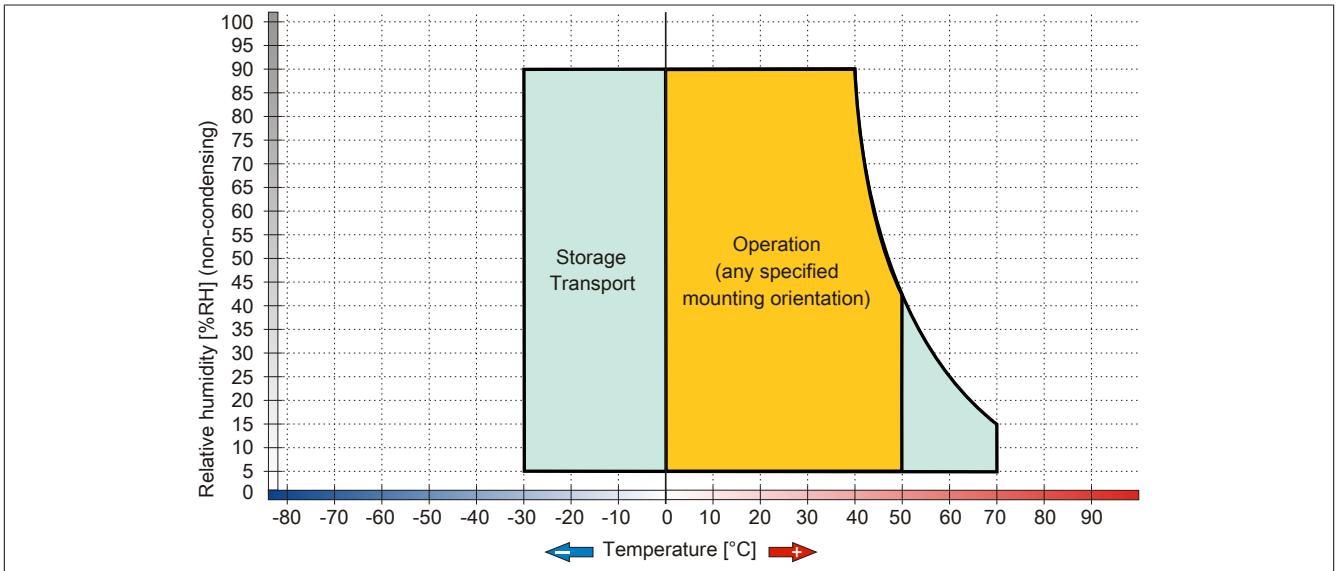

Figure 12: 5AP920.1043-01 - Temperature humidity diagram

3.1.1.1.5 Dimensions

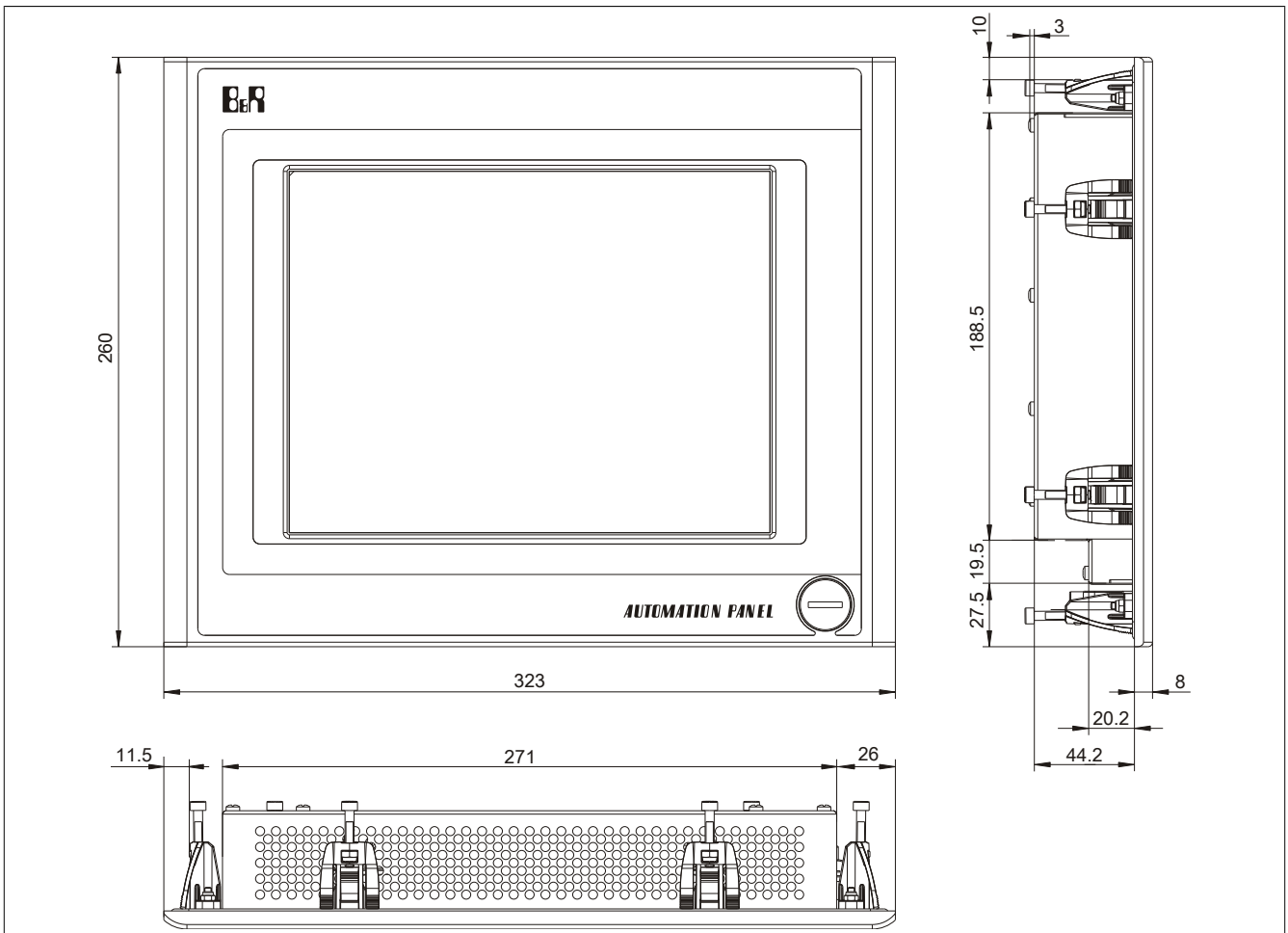

Figure 13: 5AP920.1043-01 - Dimensions

3.1.1.1.6 Cutout installation

The Automation Panel can be installed in a wall cutout using the pre-installed clamping blocks. To do so, it is necessary to make a cutout that corresponds to the following diagram.

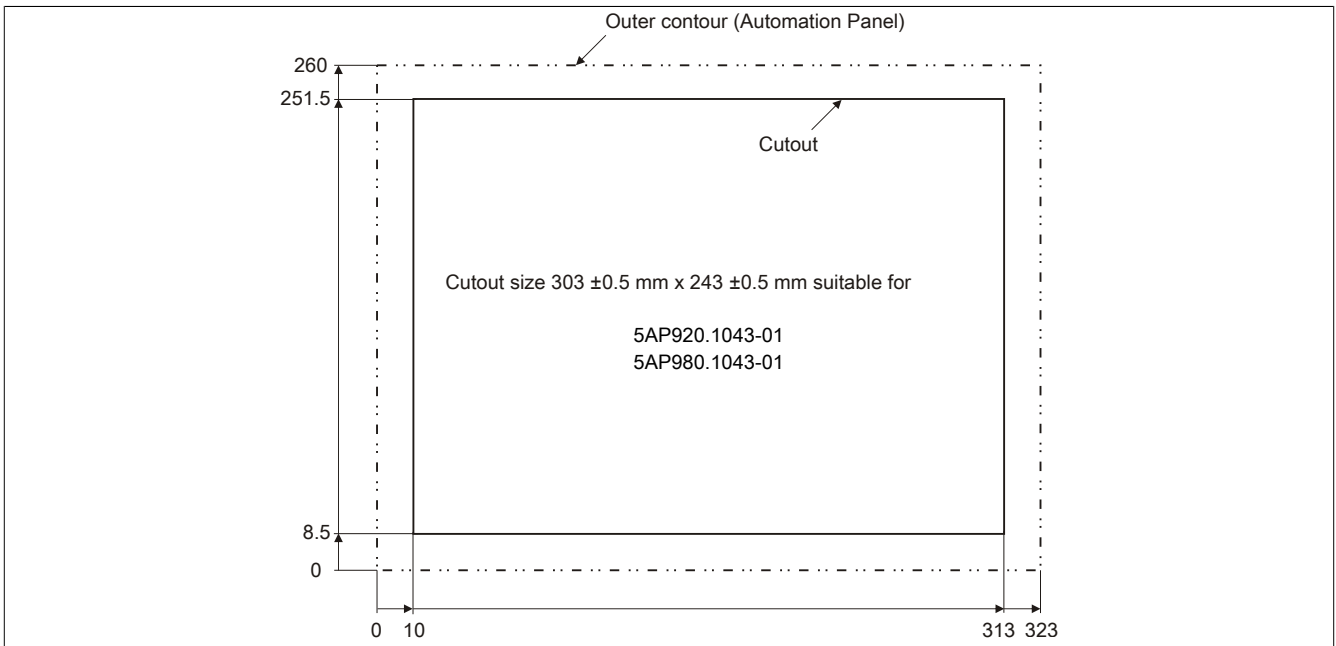

Figure 14: 5AP920.1043-01 - Cutout installation

For additional information regarding installation and mounting orientation, see "Installation" on page 109.

3.1.1.2 5AP951.1043-01

3.1.1.2.1 General information

- 10.4" VGA color TFT display
- Function keys, system keys and soft keys
- Small installation depth
- Fan-free operation
- Can be upgraded using Display Link cards

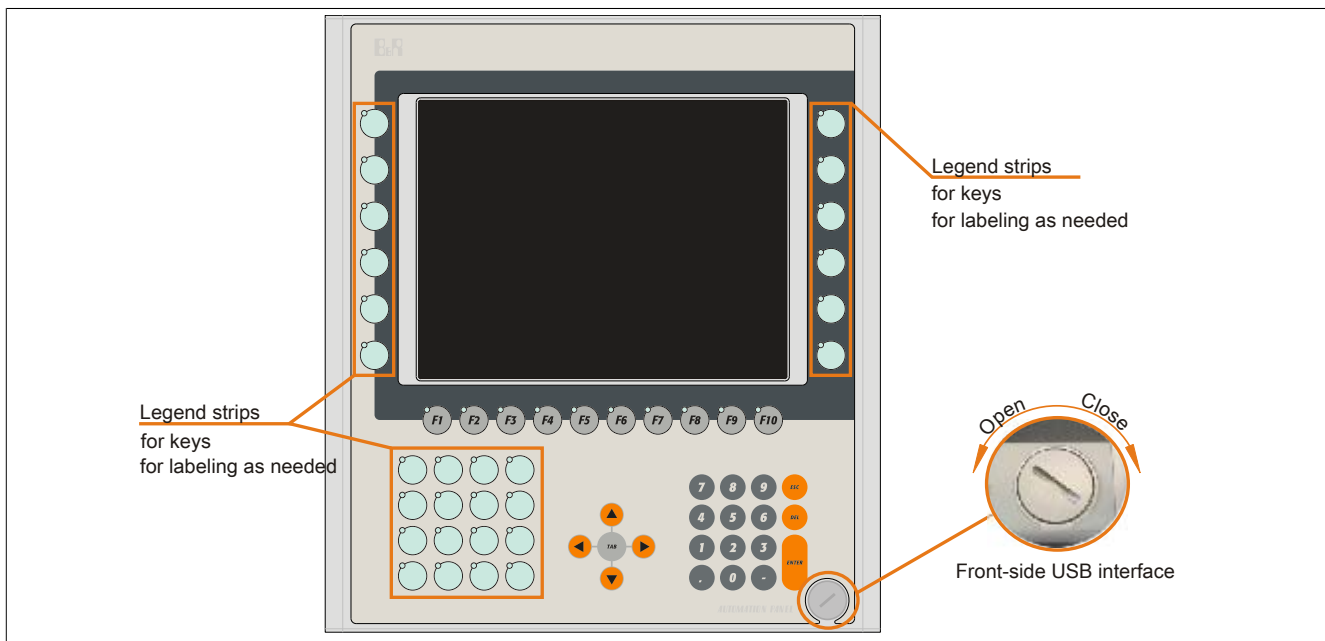

Figure 15: 5AP951.1043-01 - Front view

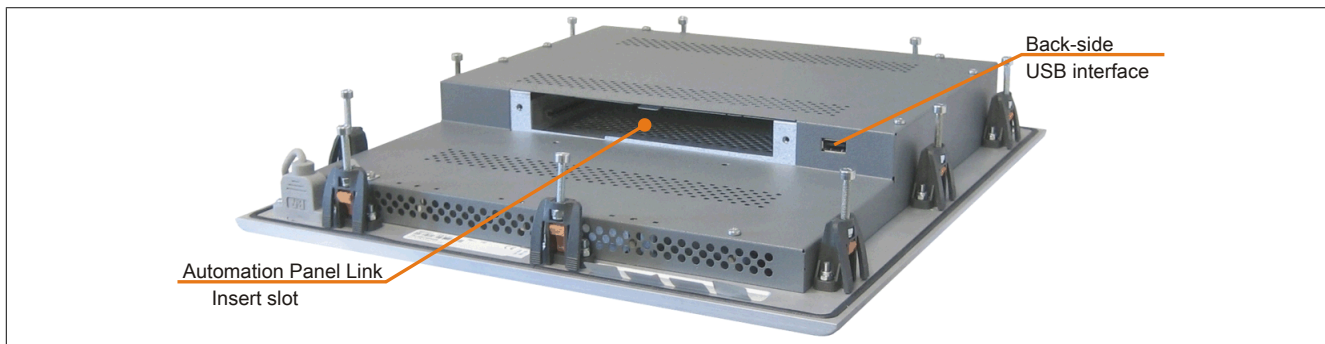

Figure 16: 5AP951.1043-01 - Rear view

3.1.1.2.2 Order data

Model number	Short description	Figure
	Display units	
5AP951.1043-01	Automation Panel AP951 10.4" VGA color TFT display; 10 soft-keys; 28 function keys and 20 system keys; 2 USB 2.0 interfaces; slot for Automation Panel link; IP 65 protection (from front). 24 VDC.	
	Required accessories	
	Display links	
5DL DVI.1000-01	Automation Panel Link DVI receiver; connections for DVI-D, RS232 and USB 2.0 (Type B); 24 VDC (order screw clamp OTB103.9 or cage clamp OTB103.91 separately).	
5DLS DL.1000-00	Automation Panel Link SDL receiver; connection for SDL In; transmission of display, touch screen, USB 1.1, matrix key and service data; 24 VDC (order screw clamp OTB103.9 or cage clamp OTB103.91 separately).	
5DLS DL.1000-01	Automation Panel Link SDL transceiver; connections for SDL In and SDL Out; transmission of display, touch screen, USB 1.1, matrix key and service data; 24 VDC (order screw clamp OTB103.9 or cage clamp OTB103.91 separately).	

Table 11: 5AP951.1043-01 - Order data

Model number	Short description	Figure
0TB103.9	Connector 24 VDC - 3-pin female - Screw clamps 3.31 mm ²	
0TB103.91	Connector 24 VDC - 3-pin female - Cage clamps 3.31 mm ²	
	Optional accessories	
	Accessories	
5AC900.104X-03	Legend Strips Template 10,4" for Automation Panel 5AP951.1043-01 and 5AP981.1043-01; for 1 device.	

Table 11: 5AP951.1043-01 - Order data

3.1.1.2.3 Technical data

Product ID	5AP951.1043-01
General information	
B&R ID code	0x1D5C
Certification CE	Yes
Interfaces	
USB ¹⁾	
Quantity	2
Type	USB 2.0 ²⁾
Execution	Type A
Transfer rate	Low speed (1.5 Mbit/s), full speed (12 Mbit/s), high speed (480 Mbit/s)
Current load	Max. 500mA per connection
Display	
Type	Color TFT
Display size	10.4" (264 mm)
Colors	262144
Resolution	VGA, 640 x 480 pixels
Contrast	300:1
Viewing angles	
Horizontal	Direction R = 70° / Direction L = 70°
Vertical	Direction U = 40° / direction D = 70°
Backlight	
Type	CCFL
Brightness	350 cd/m ²
Half-brightness time ³⁾	50,000 h
Filter glass	
Transmittance	95%
Coating	On both sides
Touch screen	
Technology	-
Controller	-
Transmittance	-
Keys	
Function keys	28 with LED (yellow)
Soft keys	10 with LED (yellow)
System keys	Numeric keys, cursor block
Service life	> 1,000,000 actuations at 1 ±0.3 N to 3 ±0.3 N actuating force
LED brightness Yellow	Typ. 12 mcd
Inserts	
Compatible installation for PPC300 insert	No
Electrical characteristics	
Nominal voltage	24 VDC ±25%
Nominal current	Max. 3.2 A ⁴⁾
Starting current	Typ. 6 A, max. 30 A for < 300 µs
Power consumption	Typ. 10 W (without LED), max. 14 W or 20 W with USB (without insert)
Electrical isolation	Yes
Operating conditions	
EN 60529 protection	IP20 back side (only with Automation Panel Link card inserted) IP65 / NEMA 250 type 4X indoor, dust and sprayed water protection (front side)
Environmental conditions	
Temperature Operation	Without Rittal housing Mounting orientation 0°: 0 to 55°C Mounting orientations to -45° display above: 0 to 55°C Mounting orientations to +45° display below: 0 to 55°C With Rittal housing Mounting orientation 0°: 0 to 50°C Mounting orientations to -45° display above: 0 to 45°C Mounting orientations to +45° display below: 0 to 45°C
Storage Transport	-30 to 70°C -30 to 70°C

Table 12: 5AP951.1043-01 - Technical data

Product ID	5AP951.1043-01
Vibration	
Operation (continuous)	2 to 9 Hz: 1.75 mm amplitude / 9 to 200 Hz: 0.5 g
Operation (occasional)	2 to 9 Hz: 3.5 mm amplitude / 9 to 200 Hz: 1 g
Storage	2 to 8 Hz: 7.5 mm amplitude / 8 to 200 Hz: 2 g / 200 to 500 Hz: 4 g
Transport	2 to 8 Hz: 7.5 mm amplitude / 8 to 200 Hz: 2 g / 200 to 500 Hz: 4 g
Shock	
Operation	15 g, 11 ms
Storage	30 g, 15 ms
Transport	30 g, 15 ms
Altitude	
Operation	Max. 3000 m ⁵⁾
Mechanical characteristics	
Housing	
Material	Metal
Paint	Similar to Pantone432CV
Front ⁶⁾	
Frame	Naturally anodized aluminum
Design	Gray
Panel overlay	
Material	Polyester
Light background	Similar to Pantone 427CV
Dark gray border around display	Similar to Pantone432CV
Dark gray keys	Similar to Pantone 431CV
Orange keys	Similar to Pantone 151CV
Color slide-in labels	Similar to Pantone 429CV
Gasket	Flat gasket around display front
Dimensions	
Width	323 mm
Height	358 mm
Depth	55 mm
Weight	Approx. 3600 g

Table 12: 5AP951.1043-01 - Technical data

- 1) USB devices can only be connected directly to the Automation Panel (without a hub).
- 2) Depends on the transfer technology, the transfer distance and the Automation Panel Link insert card used.
- 3) At 25°C ambient temperature. Reducing the brightness by 50% can result in an approximate 50% increase of the half-brightness time.
- 4) The listed value applies to the Automation Panel device with an inserted Automation Panel Link card.
- 5) Derating the maximum ambient temperature - typically 1°C per 1000 meters (from 500 meters above sea level).
- 6) Depending on the process or batch, there may be visible deviations in the color and surface structure.

3.1.1.2.4 Temperature humidity diagram

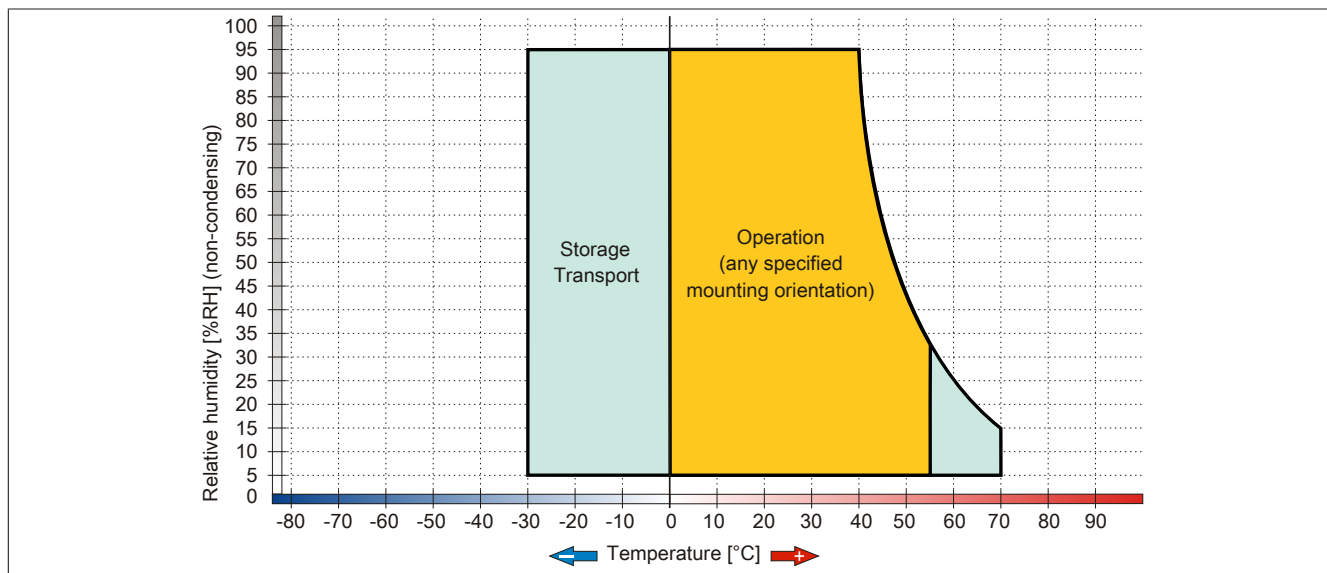

Figure 17: 5AP951.1043-01 - Temperature humidity diagram

3.1.1.2.5 Dimensions

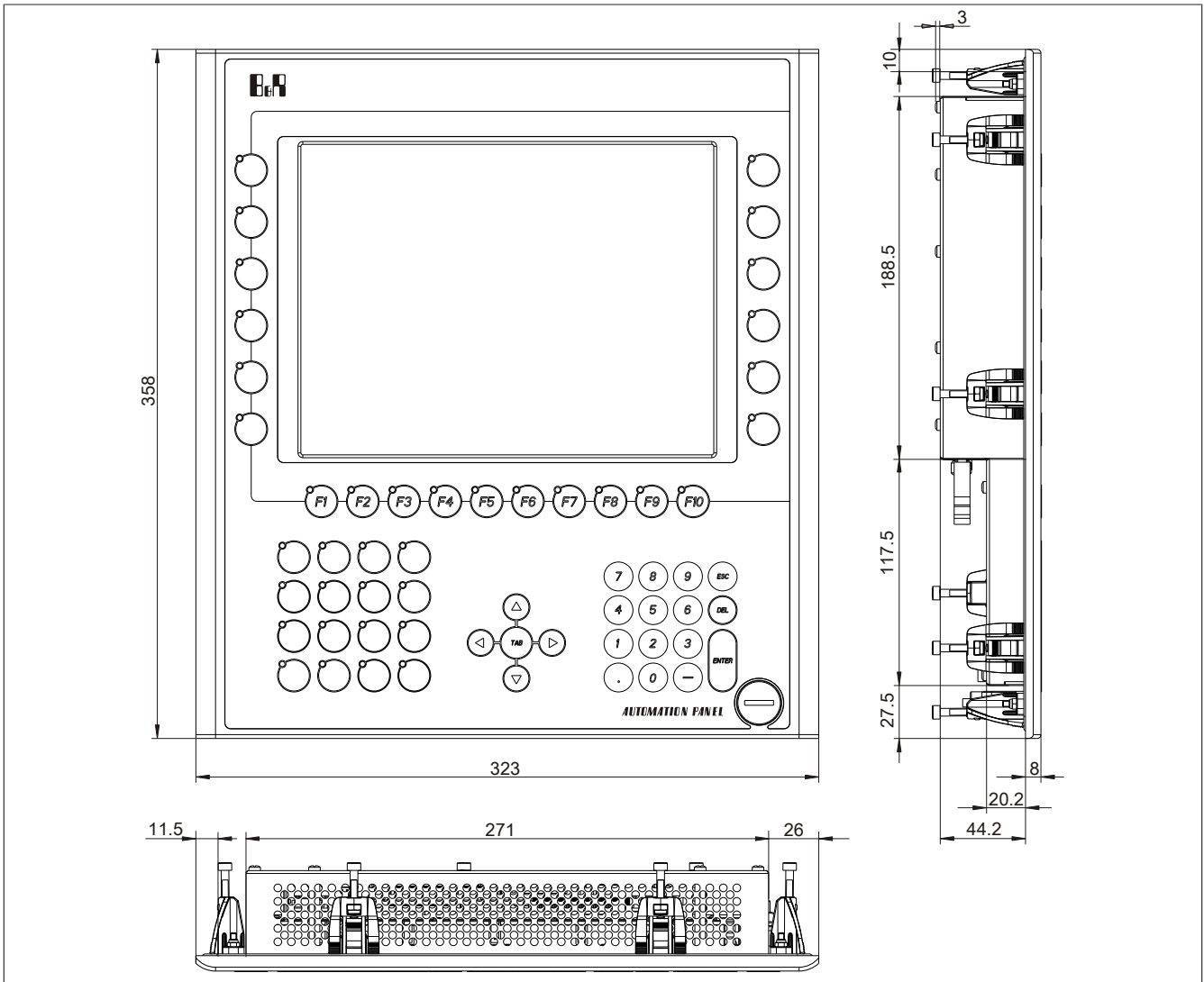

Figure 18: 5AP951.1043-01 - Dimensions

3.1.1.2.6 Cutout installation

The Automation Panel can be installed in a wall cutout using the pre-installed clamping blocks. To do so, it is necessary to make a cutout that corresponds to the following diagram.

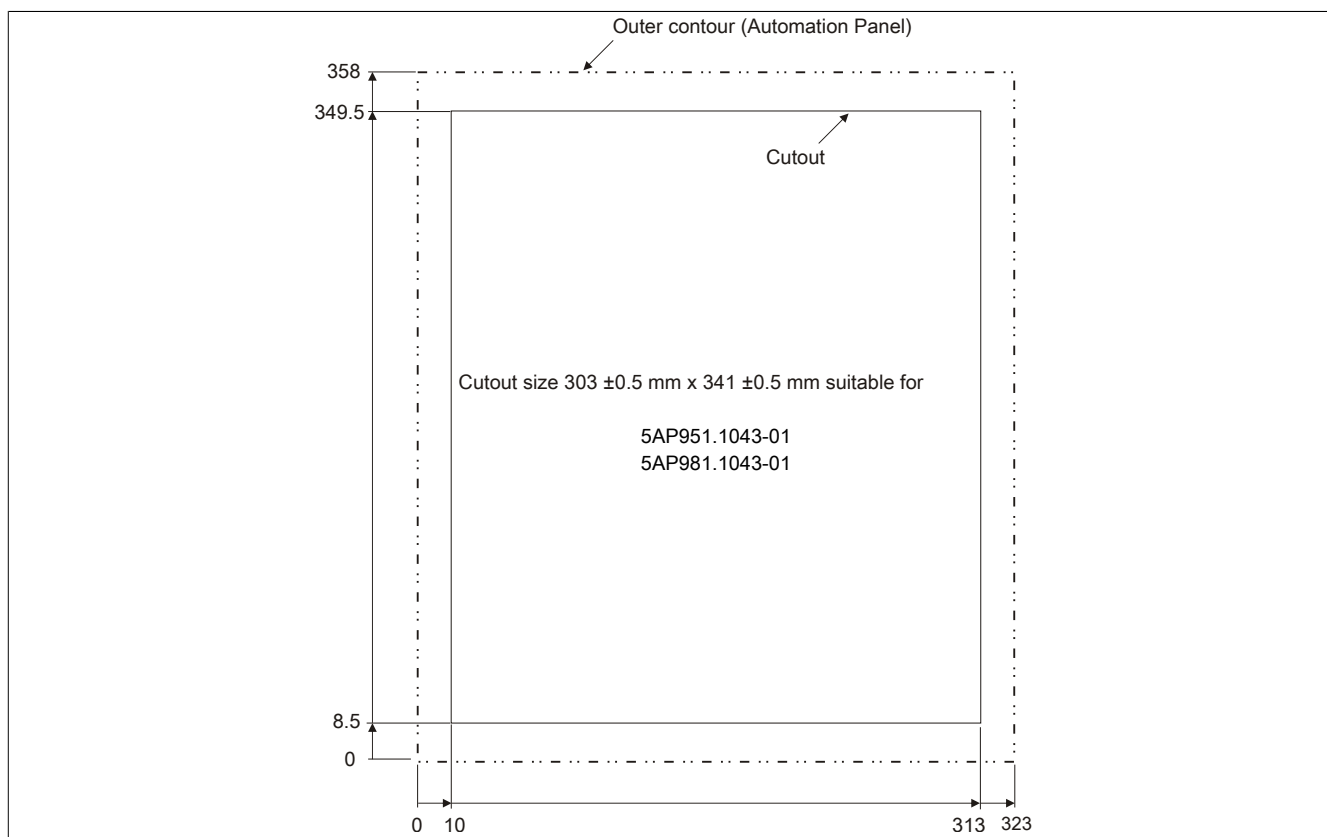

Figure 19: 5AP951.1043-01 - Cutout installation

For additional information regarding installation and mounting orientation, see "Installation" on page 109.

3.1.1.3 5AP952.1043-01

3.1.1.3.1 General information

- 10.4" VGA color TFT display
- Function and system keys
- Small installation depth
- Fan-free operation
- Can be upgraded using Display Link cards

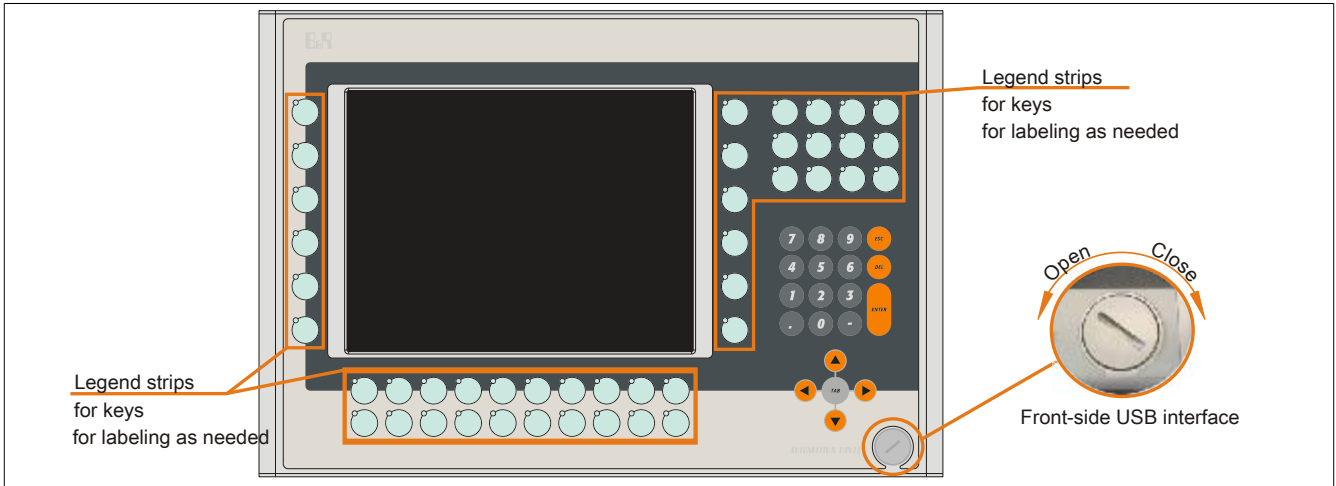

Figure 20: 5AP952.1043-01 - Front view

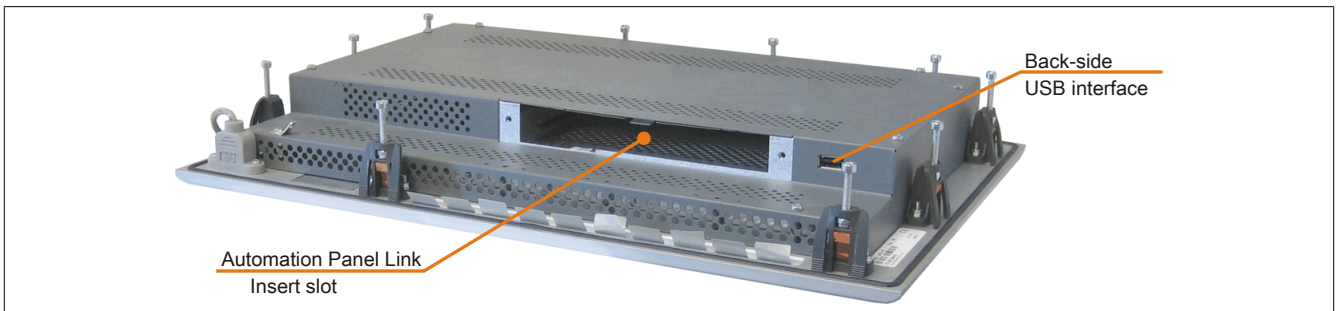

Figure 21: 5AP952.1043-01 - Rear view

3.1.1.3.2 Order data

Model number	Short description	Figure
	Display units	
5AP952.1043-01	Automation Panel AP952 10.4" VGA color TFT display; 44 function keys and 20 system keys; 2 USB 2.0 interfaces; slot for Automation Panel link; IP 65 protection (from front). 24 VDC.	
	Required accessories	
	Display links	
5DLDLVI.1000-01	Automation Panel Link DVI receiver; connections for DVI-D, RS232 and USB 2.0 (Type B); 24 VDC (order screw clamp 0TB103.9 or cage clamp 0TB103.91 separately).	
5DLSDL.1000-00	Automation Panel Link SDL receiver; connection for SDL In; transmission of display, touch screen, USB 1.1, matrix key and service data; 24 VDC (order screw clamp 0TB103.9 or cage clamp 0TB103.91 separately).	
5DLSDL.1000-01	Automation Panel Link SDL transceiver; connections for SDL In and SDL Out; transmission of display, touch screen, USB 1.1, matrix key and service data; 24 VDC (order screw clamp 0TB103.9 or cage clamp 0TB103.91 separately).	
	Terminal blocks	
0TB103.9	Connector 24 VDC - 3-pin female - Screw clamps 3.31 mm ²	
0TB103.91	Connector 24 VDC - 3-pin female - Cage clamps 3.31 mm ²	
	Optional accessories	
	Accessories	
5AC900.104X-04	Legend Strips Template 10,4" for Automation Panel 5AP952.1043-01 and 5AP982.1043-01; for 1 device.	

Table 13: 5AP952.1043-01 - Order data

3.1.1.3.3 Technical data

Product ID	5AP952.1043-01
General information	
B&R ID code	0x1D5B
Certification CE	Yes
Interfaces	
USB ¹⁾	
Quantity	2
Type	USB 2.0 ²⁾
Execution	Type A
Transfer rate	Low speed (1.5 Mbit/s), full speed (12 Mbit/s), high speed (480 Mbit/s)
Current load	Max. 500mA per connection
Display	
Type	Color TFT
Display size	10.4" (264 mm)
Colors	262144
Resolution	VGA, 640 x 480 pixels
Contrast	300:1
Viewing angles	
Horizontal	Direction R = 70° / Direction L = 70°
Vertical	Direction U = 40° / direction D = 70°
Backlight	
Type	CCFL
Brightness	350 cd/m ²
Half-brightness time ³⁾	50,000 h
Filter glass	
Transmittance	95%
Coating	On both sides
Touch screen	
Technology	-
Controller	-
Transmittance	-
Keys	
Function keys	44 with LED (yellow)
Soft keys	No
System keys	Numeric keys, cursor block
Service life	> 1,000,000 actuations at 1 ±0.3 N to 3 ±0.3 N actuating force
LED brightness	
Yellow	Typ. 12 mcd
Inserts	
Compatible installation for PPC300 insert	No
Electrical characteristics	
Nominal voltage	24 VDC ±25%
Nominal current	Max. 3.2 A ⁴⁾
Starting current	Typ. 6 A, max. 30 A for < 300 µs
Power consumption	Typ. 10 W (without LED), max. 14 W or 21 W with USB (without insert)
Electrical isolation	Yes
Operating conditions	
EN 60529 protection	IP20 back side (only with Automation Panel Link card inserted) IP65 / NEMA 250 type 4X indoor, dust and sprayed water protection (front side)
Environmental conditions	
Temperature	
Operation	Without Rittal housing Mounting orientation 0°: 0 to 55°C Mounting orientations to -45° display above: 0 to 55°C Mounting orientations to +45° display below: 0 to 55°C With Rittal housing Mounting orientation 0°: 0 to 50°C Mounting orientations to -45° display above: 0 to 45°C Mounting orientations to +45° display below: 0 to 45°C
Storage	-30 to 70°C
Transport	-30 to 70°C
Vibration	
Operation (continuous)	2 to 9 Hz: 1.75 mm amplitude / 9 to 200 Hz: 0.5 g
Operation (occasional)	2 to 9 Hz: 3.5 mm amplitude / 9 to 200 Hz: 1 g
Storage	2 to 8 Hz: 7.5 mm amplitude / 8 to 200 Hz: 2 g / 200 to 500 Hz: 4 g
Transport	2 to 8 Hz: 7.5 mm amplitude / 8 to 200 Hz: 2 g / 200 to 500 Hz: 4 g
Shock	
Operation	15 g, 11 ms
Storage	30 g, 15 ms
Transport	30 g, 15 ms
Altitude	
Operation	Max. 3000 m ⁵⁾

Table 14: 5AP952.1043-01 - Technical data

Product ID	5AP952.1043-01
Mechanical characteristics	
Housing	
Material	Metal
Paint	Similar to Pantone432CV
Front ⁶⁾	
Frame	Naturally anodized aluminum
Design	Gray
Panel overlay	
Material	Polyester
Light background	Similar to Pantone 427CV
Dark gray border around display	Similar to Pantone432CV
Dark gray keys	Similar to Pantone 431CV
Orange keys	Similar to Pantone 151CV
Color slide-in labels	Similar to Pantone 429CV
Gasket	Flat gasket around display front
Dimensions	
Width	423 mm
Height	288 mm
Depth	55 mm
Weight	Approx. 3800 g

Table 14: 5AP952.1043-01 - Technical data

- 1) USB devices can only be connected directly to the Automation Panel (without a hub).
- 2) Depends on the transfer technology, the transfer distance and the Automation Panel Link insert card used.
- 3) At 25°C ambient temperature. Reducing the brightness by 50% can result in an approximate 50% increase of the half-brightness time.
- 4) The listed value applies to the Automation Panel device with an inserted Automation Panel Link card.
- 5) Derating the maximum ambient temperature - typically 1°C per 1000 meters (from 500 meters above sea level).
- 6) Depending on the process or batch, there may be visible deviations in the color and surface structure.

3.1.1.3.4 Temperature humidity diagram

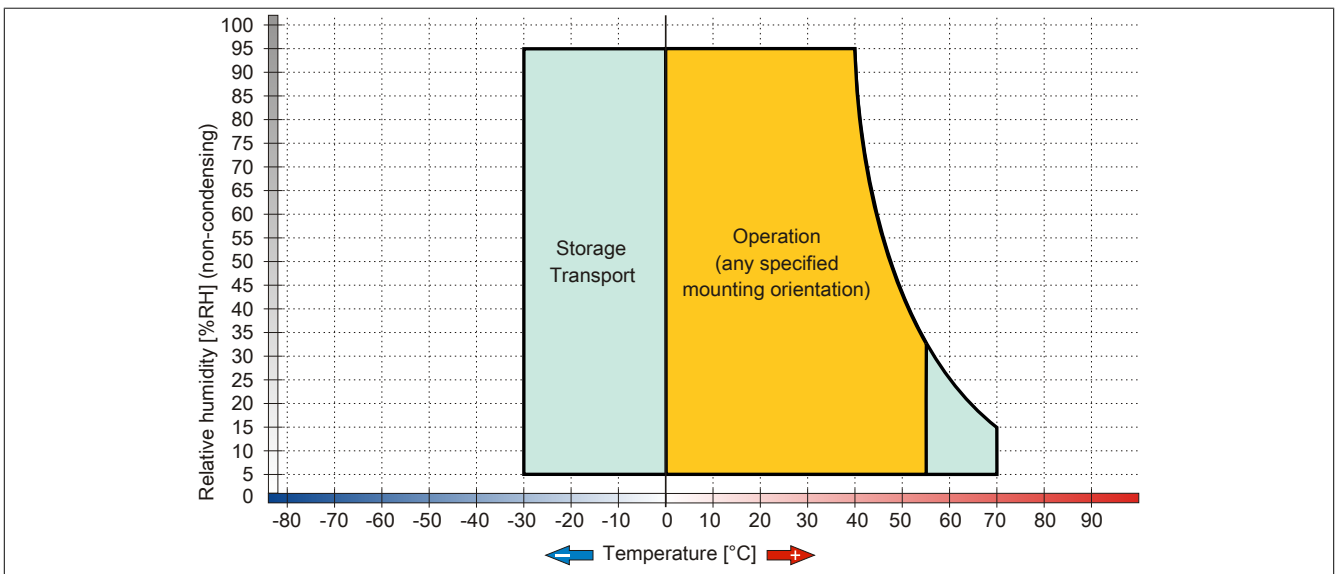

Figure 22: 5AP952.1043-01 - Temperature humidity diagram

3.1.1.3.5 Dimensions

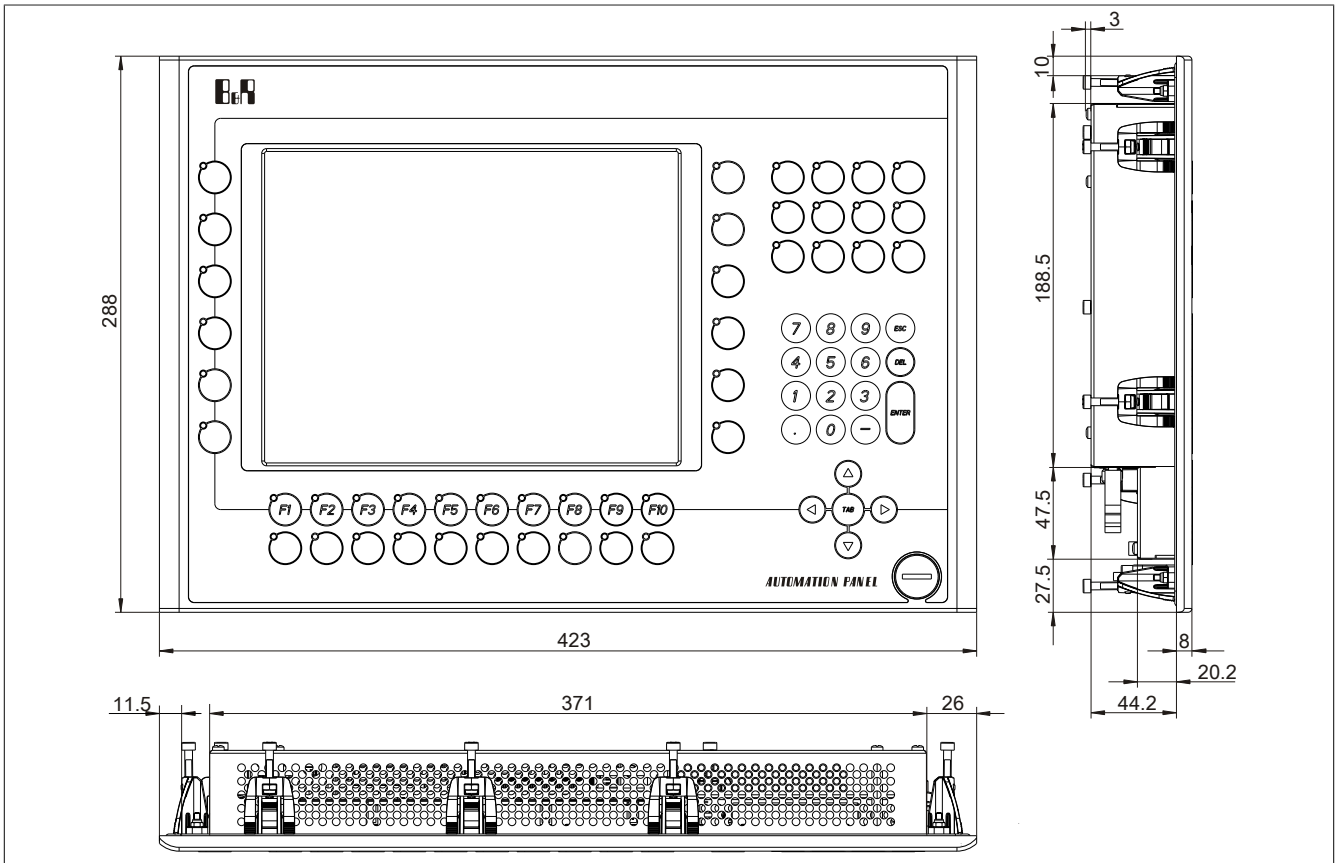

Figure 23: 5AP952.1043-01 - Dimensions

3.1.1.3.6 Cutout installation

The Automation Panel can be installed in a wall cutout using the pre-installed clamping blocks. To do so, it is necessary to make a cutout that corresponds to the following diagram.

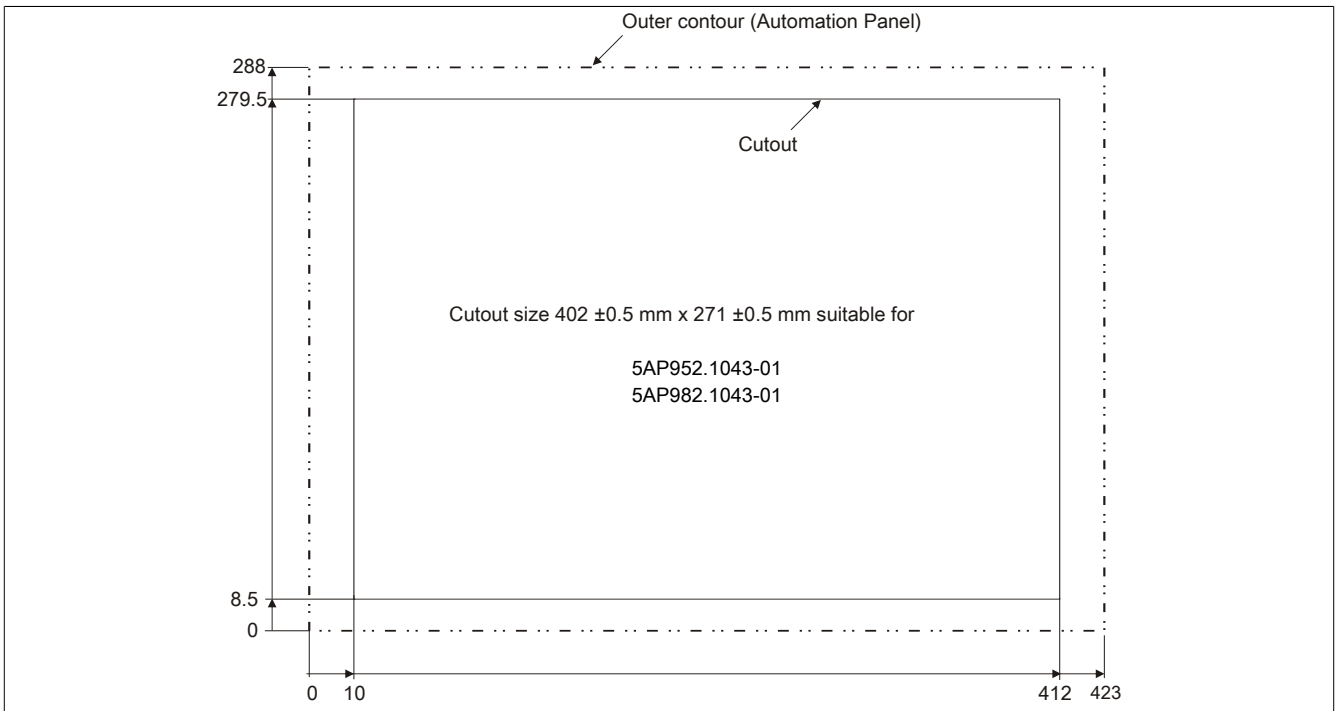

Figure 24: 5AP952.1043-01 - Cutout installation

For additional information regarding installation and mounting orientation, see "Installation" on page 109.

3.1.1.4 5AP980.1043-01

3.1.1.4.1 General information

- 10.4" VGA color TFT display
- Analog resistive touch screen
- Function keys and soft keys
- Small installation depth
- Fan-free operation
- Can be upgraded with Display Link cards or PPC300

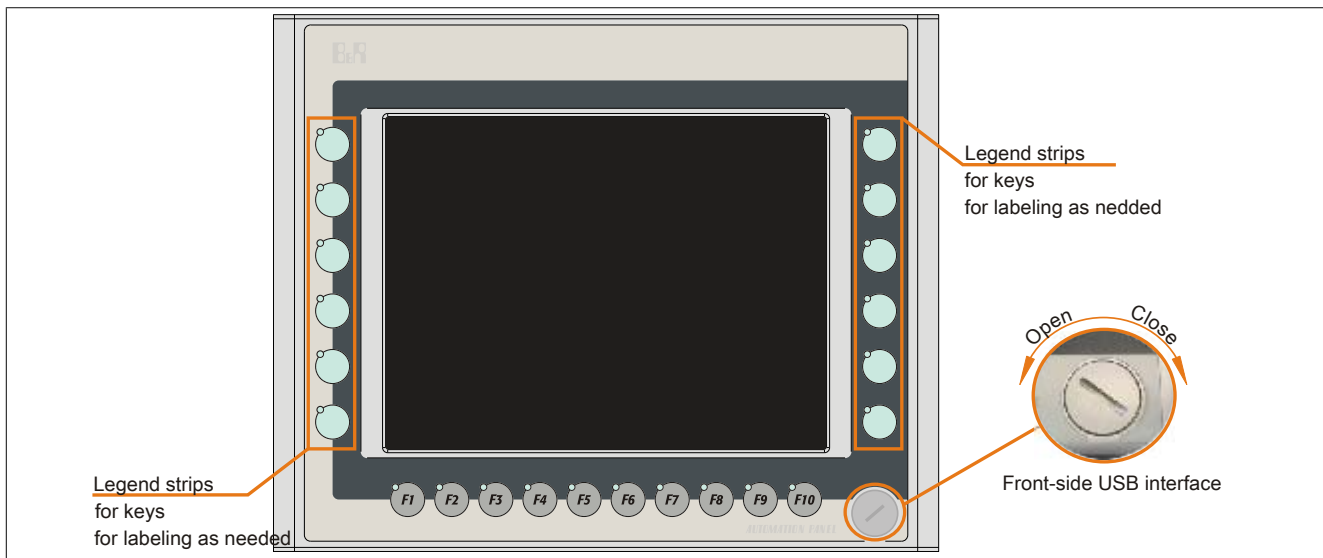

Figure 25: 5AP980.1043-01 - Front view

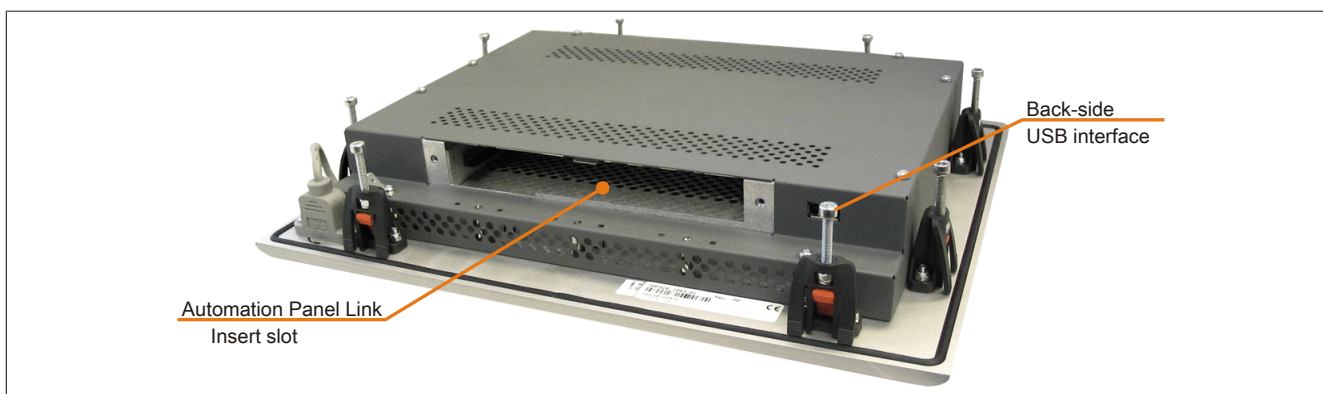

Figure 26: 5AP980.1043-01 - Rear view

3.1.1.4.2 Order data

Model number	Short description	Figure
	Display units	
5AP980.1043-01	Automation Panel AP980, 10.4" VGA color TFT display with touch screen (resistive); 10 soft keys and 12 function keys; 2 USB 2.0 interfaces; insert for Automation Panel Link; IP65 protection (front). 24 VDC.	
	Required accessories	
	Display links	
5DL DVI.1000-01	Automation Panel Link DVI receiver; connections for DVI-D, RS232 and USB 2.0 (Type B); 24 VDC (order screw clamp 0TB103.9 or cage clamp 0TB103.91 separately).	
5DLS D3.1000-00	Automation Panel Link SDL3 receiver - For Automation Panel 920/98x	
5DLS DL.1000-00	Automation Panel Link SDL receiver; connection for SDL In; transmission of display, touch screen, USB 1.1, matrix key and service data; 24 VDC (order screw clamp 0TB103.9 or cage clamp 0TB103.91 separately).	

Table 15: 5AP980.1043-01 - Order data

Model number	Short description	Figure
5DLSDL.1000-01	Automation Panel Link SDL transceiver; connections for SDL In and SDL Out; transmission of display, touch screen, USB 1.1, matrix key and service data; 24 VDC (order screw clamp 0TB103.9 or cage clamp 0TB103.91 separately).	
	Terminal blocks	
0TB103.9	Connector 24 VDC - 3-pin female - Screw clamps 3.31 mm ²	
0TB103.91	Connector 24 VDC - 3-pin female - Cage clamps 3.31 mm ²	
	Optional accessories	
	Accessories	
5AC900.104X-05	Legend Strips Template 10,4" for Automation Panel 5AP980.1043-01; for 3 devices.	
	Panel PC 300 insert cards	
5PC310.L800-00	Panel PC 300 insert card for the Automation Panel 900; 256 MB SDRAM; CompactFlash slot (Type I); 2x ETH 10/100; RS232; USB 2.0 (via integrated USB 2.0 interfaces on the Automation Panel); battery; 24 VDC (order screw clamp 0TB103.9 or cage clamp 0TB103.91 separately)	
5PC310.L800-01	Panel PC 300 insert card for the Automation Panel 900; 512 MB SDRAM; CompactFlash slot (Type I); 2x ETH 10/100; RS232; USB 2.0 (via integrated USB 2.0 interfaces on the Automation Panel); battery; 24 VDC (order screw clamp 0TB103.9 or cage clamp 0TB103.91 separately)	

Table 15: 5AP980.1043-01 - Order data

3.1.1.4.3 Technical data

Product ID	5AP980.1043-01			
Revision	C0	D0	G0	H0
General information				
B&R ID code	0x1D5D			
Certification				
CE	Yes			
cULus	Yes			
GOST-R	Yes			
Interfaces				
USB ¹⁾				
Quantity	2			
Type	USB 2.0 ²⁾			
Execution	Type A			
Transfer rate	Low speed (1.5 Mbit/s), full speed (12 Mbit/s), high speed (480 Mbit/s)			
Current load	Max. 500 mA per connection			
Display				
Type	Color TFT			
Display size	10.4" (264 mm)			
Colors	262144		16 million	
Resolution	VGA, 640 x 480 pixels			
Contrast	300:1		700:1	
Viewing angles				
Horizontal	Direction R = 70° / Direction L = 70°		Direction R = 80° / Direction L = 80°	
Vertical	Direction U = 40° / Direction D = 70°		Direction U = 80° / Direction D = 60°	
Backlight				
Type	CCFL		LED	
Brightness	350 cd/m ²		450 cd/m ²	
Half-brightness time ³⁾	50,000 h			
Filter glass				
Transmittance	-			
Coating	-			
Touch screen ⁴⁾				
Type	Elo AccuTouch		AMT	
Technology	Analog, resistive			
Controller	Elo, serial, 12-bit			
Transmittance	80% ±5%		81% ±3%	
Keys				
Function keys	12 with LED (yellow)			
Soft keys	10 with LED (yellow)			
System keys	No			
Service life	>1,000,000 actuations at 1 ±0.3N to 3 ±0.3 N actuating force			
LED brightness				
Yellow	Typ. 12 mcd			
Inserts				
Compatible installation for PPC300 insert	No	Yes		

Table 16: 5AP980.1043-01, 5AP980.1043-01, 5AP980.1043-01, 5AP980.1043-01 - Technical data

Product ID	5AP980.1043-01	
Electrical characteristics		
Nominal voltage	24 VDC ±25%	
Nominal current	Max. 3.2 A ⁵⁾	
Starting current	Typ. 6 A, max. 30 A for <300 µs	
Power consumption	Typ. 10 W (without LED), max. 13 W or 20 W with USB (without insert)	
Electrical isolation	Yes	
Operating conditions		
EN 60529 protection	Back: IP20 (only with an inserted Automation Panel Link card) Front: IP65 / NEMA 250 type 4X indoor, dust and sprayed water protection	
Environmental conditions		
Temperature Operation	Without Rittal housing Mounting orientation 0°: 0 to 50°C Mounting orientations to -45° display above: 0 to 50°C Mounting orientations to +45° display below: 0 to 50°C	
Storage Transport	With Rittal housing Mounting orientation 0°: 0 to 50°C Mounting orientations to -45° display above: 0 to 45°C Mounting orientations to +45° display below: 0 to 45°C -30 to 70°C -30 to 70°C	
Vibration Operation (continuous) Operation (occasional) Storage Transport	2 to 9 Hz: 1.75 mm amplitude / 9 to 200 Hz: 0.5 g 2 to 9 Hz: 3.5 mm amplitude / 9 to 200 Hz: 1 g 2 to 8 Hz: 7.5 mm amplitude / 8 to 200 Hz: 2 g / 200 to 500 Hz: 4 g 2 to 8 Hz: 7.5 mm amplitude / 8 to 200 Hz: 2 g / 200 to 500 Hz: 4 g	
Shock Operation Storage Transport	15 g, 11 ms 30 g, 15 ms 30 g, 15 ms	
Altitude Operation	Max. 3000 m ⁶⁾	
Mechanical characteristics		
Housing Material Paint	Metal Similar to Pantone 432CV	
Front ⁷⁾ Frame Design Panel overlay Material Light background Dark gray border around display Color slide-in labels Gasket	Naturally anodized aluminum Gray Polyester Similar to Pantone 427CV Similar to Pantone 432CV Similar to Pantone 429CV Flat gasket around display front	
Dimensions Width Height Depth	323 mm 260 mm 55 mm	
Weight	Approx. 2900 g	Approx. 2600 g

Table 16: 5AP980.1043-01, 5AP980.1043-01, 5AP980.1043-01, 5AP980.1043-01 - Technical data

- 1) USB devices can only be connected to the Automation Panel directly (i.e. without a hub).
- 2) Depends on the transmission technology, the transfer distance and the Automation Panel Link plug-in card being used.
- 3) At an ambient temperature of 25°C. Reducing the brightness by 50% can result in an approximately 50% increase in the half-brightness time.
- 4) Touch screen drivers for approved operating systems are available in the Downloads section of the B&R website.
- 5) The specified value applies to Automation Panel systems with an inserted Automation Panel Link card.
- 6) The maximum ambient temperature is typically derated by 1°C per 1000 meters (starting at 500 meters above sea level).
- 7) There may be visible deviations in the color and surface appearance depending on the process or batch.

3.1.1.4.4 Temperature humidity diagram

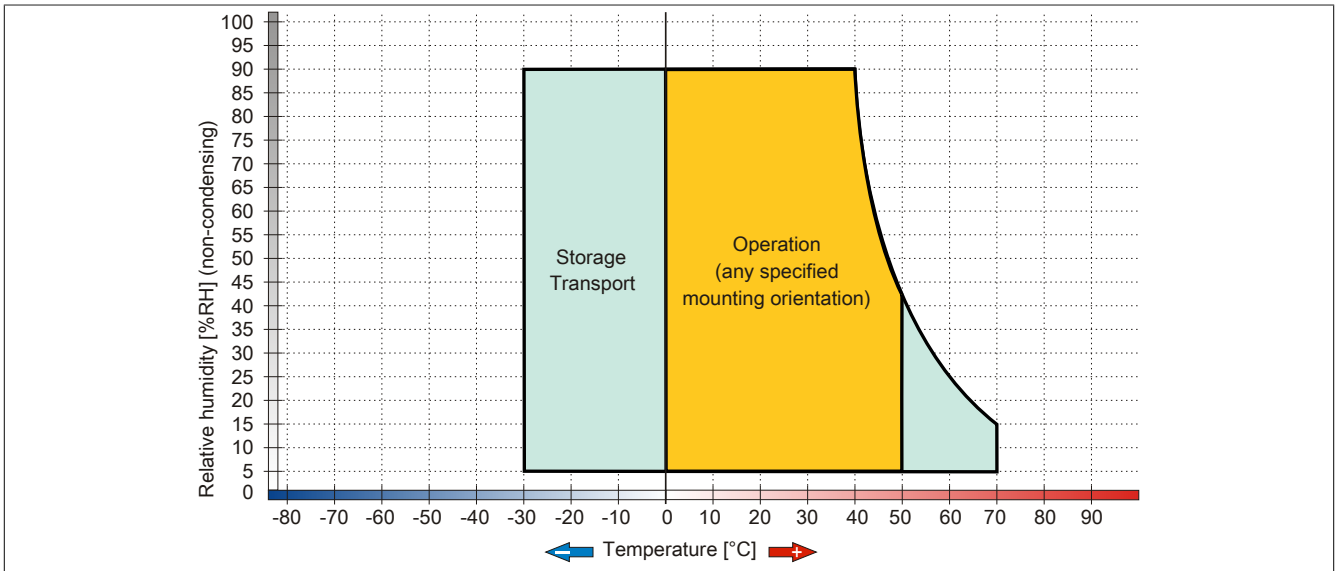

Figure 27: 5AP980.1043-01 - Temperature humidity diagram

3.1.1.4.5 Dimensions

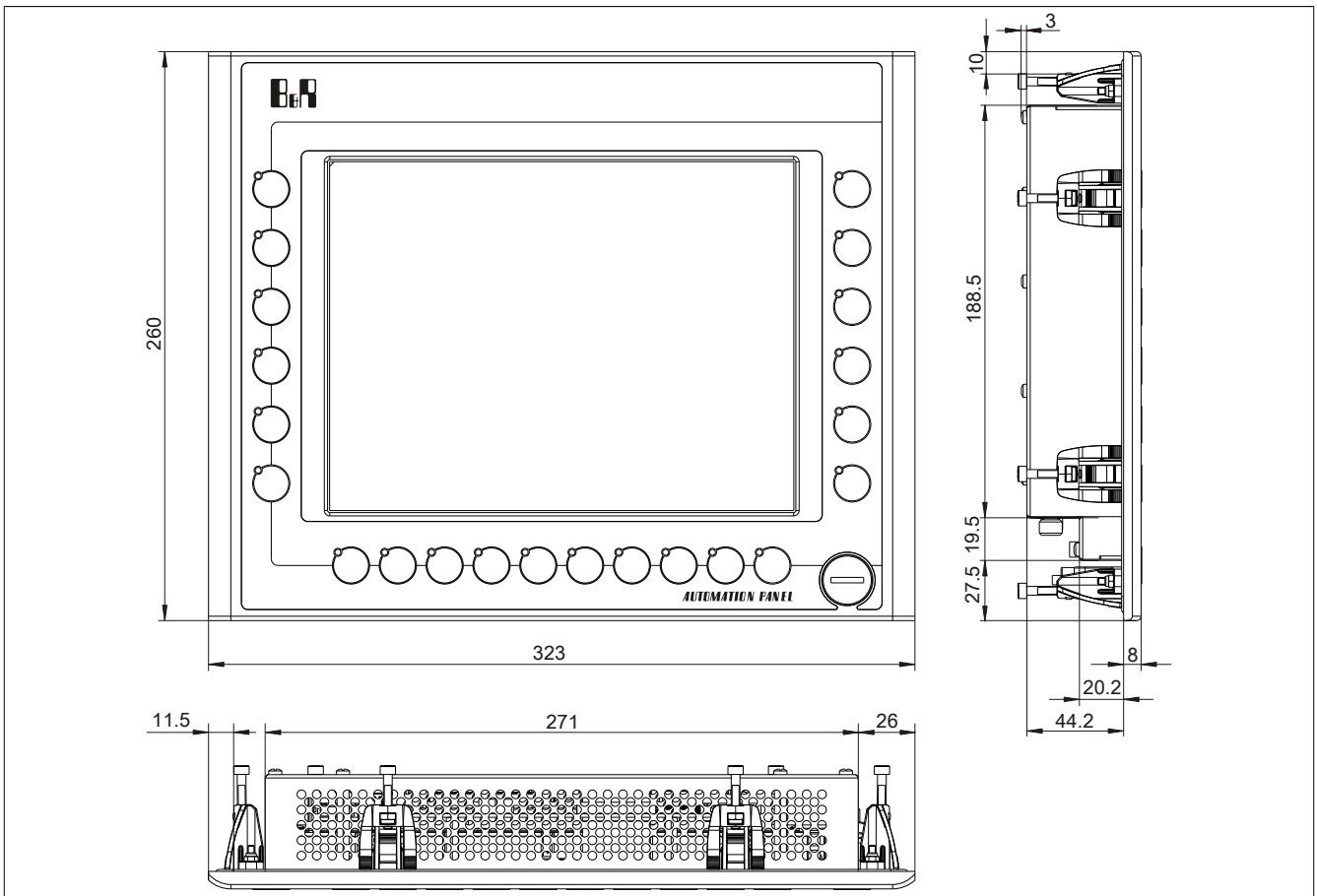

Figure 28: 5AP980.1043-01 - Dimensions

3.1.1.4.6 Cutout installation

The Automation Panel can be installed in a wall cutout using the pre-installed clamping blocks. To do so, it is necessary to make a cutout that corresponds to the following diagram.

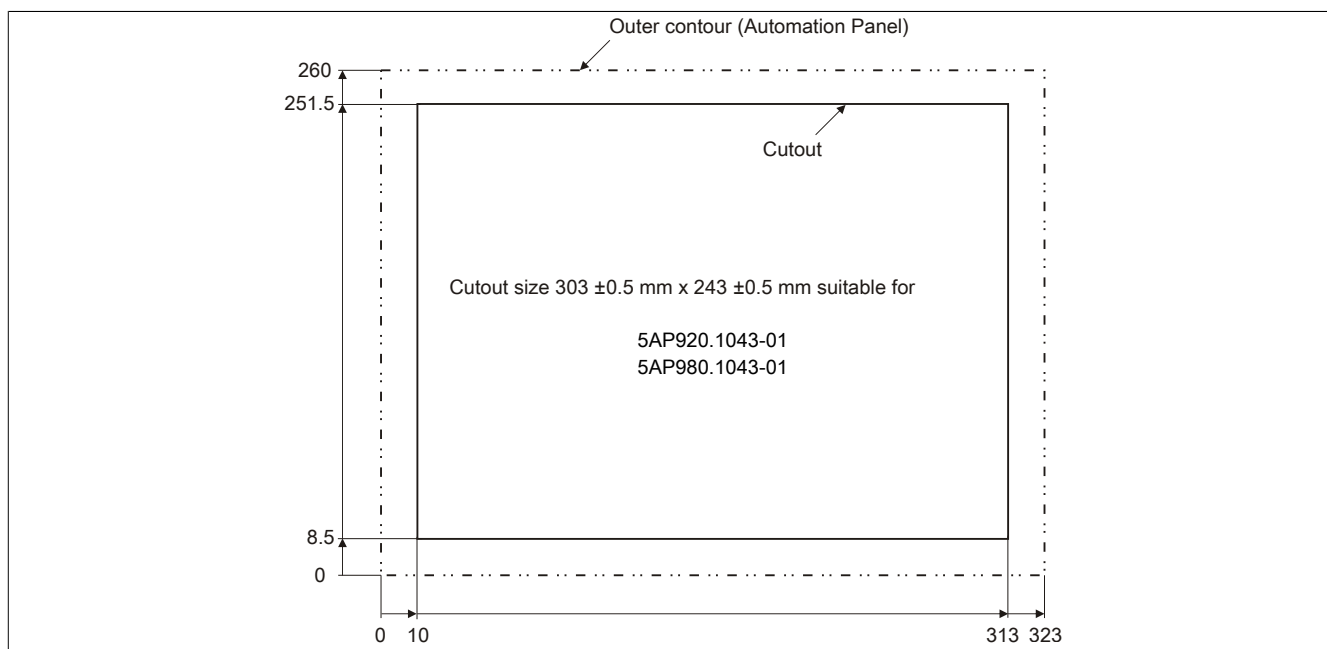

Figure 29: 5AP980.1043-01 - Cutout installation

For additional information regarding installation and mounting orientation, see "Installation" on page 109.

3.1.1.5 5AP981.1043-01

3.1.1.5.1 General information

- 10.4" VGA color TFT display
- Analog resistive touch screen
- Function keys, system keys and soft keys
- Small installation depth
- Fan-free operation
- Can be upgraded with Display Link cards or PPC300

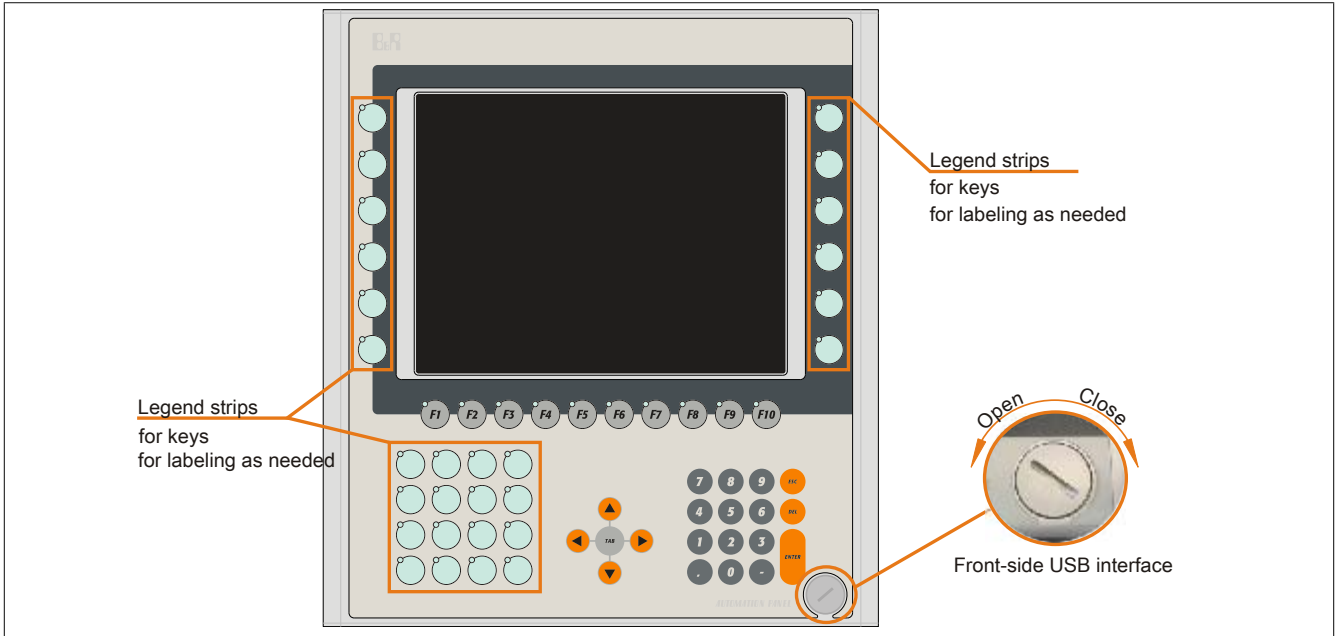

Figure 30: 5AP981.1043-01 - Front view

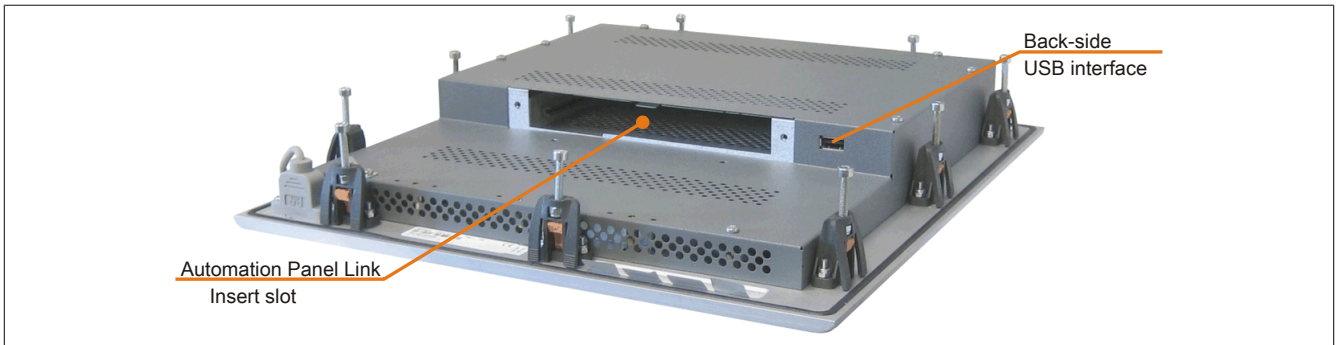

Figure 31: 5AP981.1043-01 - Rear view

3.1.1.5.2 Order data

Model number	Short description	Figure
	Display units	
5AP981.1043-01	Automation Panel AP981; 10.4" VGA color TFT display with touch screen (resistive); 10 soft keys; 28 function keys and 20 system keys; 2 USB 2.0 interfaces; insert for Automation Panel Link; IP65 protection (front). 24 VDC.	
	Required accessories	
	Display links	
5DLDMI.1000-01	Automation Panel Link DVI receiver; connections for DVI-D, RS232 and USB 2.0 (Type B); 24 VDC (order screw clamp OTB103.9 or cage clamp OTB103.91 separately).	
5DLS3.1000-00	Automation Panel Link SDL3 receiver - For Automation Panel 920/98x	
5DLSL.1000-00	Automation Panel Link SDL receiver; connection for SDL In; transmission of display, touch screen, USB 1.1, matrix key and service data; 24 VDC (order screw clamp OTB103.9 or cage clamp OTB103.91 separately).	
5DLSL.1000-01	Automation Panel Link SDL transceiver; connections for SDL In and SDL Out; transmission of display, touch screen, USB 1.1, matrix key and service data; 24 VDC (order screw clamp OTB103.9 or cage clamp OTB103.91 separately).	
	Terminal blocks	
OTB103.9	Connector 24 VDC - 3-pin female - Screw clamps 3.31 mm ²	
OTB103.91	Connector 24 VDC - 3-pin female - Cage clamps 3.31 mm ²	
	Optional accessories	
	Accessories	
5AC900.104X-03	Legend Strips Template 10.4" for Automation Panel 5AP951.1043-01 and 5AP981.1043-01; for 1 device.	
	Panel PC 300 insert cards	
5PC310.L800-00	Panel PC 300 insert card for the Automation Panel 900; 256 MB SDRAM; CompactFlash slot (Type I); 2x ETH 10/100; RS232; USB 2.0 (via integrated USB 2.0 interfaces on the Automation Panel); battery; 24 VDC (order screw clamp OTB103.9 or cage clamp OTB103.91 separately)	
5PC310.L800-01	Panel PC 300 insert card for the Automation Panel 900; 512 MB SDRAM; CompactFlash slot (Type I); 2x ETH 10/100; RS232; USB 2.0 (via integrated USB 2.0 interfaces on the Automation Panel); battery; 24 VDC (order screw clamp OTB103.9 or cage clamp OTB103.91 separately)	

Table 17: 5AP981.1043-01 - Order data

3.1.1.5.3 Technical data

Product ID	5AP981.1043-01			
Revision	C0	D0	H0	I0
General information				
B&R ID code	0x1C63			
Certification				
CE	Yes			
cULus	Yes			
GOST-R	Yes			
Interfaces				
USB ¹⁾				
Quantity	2			
Type	USB 2.0 ²⁾			
Execution	Type A			
Transfer rate	Low speed (1.5 Mbit/s), full speed (12 Mbit/s), high speed (480 Mbit/s)			
Current load	Max. 500 mA per connection			
Display				
Type	TFT color			
Display size	10.4" (264 mm)			
Colors	262144			16 million
Resolution	VGA, 640 x 480 pixels			
Contrast	300:1		700:1	
Viewing angles				
Horizontal	Direction R = 70° / Direction L = 70°			Direction R = 80° / Direction L = 80°
Vertical	Direction U = 40° / Direction D = 70°			Direction U = 80° / Direction D = 60°
Backlight				
Type	CCFL		LED	
Brightness	350 cd/m ²		450 cd/m ²	
Half-brightness time ³⁾	50,000 h			

Table 18: 5AP981.1043-01, 5AP981.1043-01, 5AP981.1043-01, 5AP981.1043-01 - Technical data

Product ID	5AP981.1043-01		
Filter glass			
Transmittance	-		
Coating	-		
Touch screen ⁴⁾			
Type	Elo AccuTouch		AMT
Technology	Analog, resistive		
Controller	Elo, serial, 12-bit		
Transmittance	80% ±5%		81% ±3%
Keys			
Function keys	28 with LED (yellow)		
Soft keys	10 with LED (yellow)		
System keys	Numeric keys, cursor block		
Service life	>1,000,000 actuations at 1 ±0.3N to 3 ±0.3 N actuating force		
LED brightness			
Yellow	Typ. 12 mcd		
Inserts			
Compatible installation for PPC300 insert	No		Yes
Electrical characteristics			
Nominal voltage	24 VDC ±25%		
Nominal current	Max. 3.2 A ⁵⁾		
Starting current	Typ. 6 A, max. 30 A for <300 µs		
Power consumption	Typ. 10 W (without LED), max. 14 W or 21 W with USB (without insert)		
Electrical isolation	Yes		
Operating conditions			
EN 60529 protection	Back: IP20 (only with an inserted Automation Panel Link card) Front: IP65 / NEMA 250 type 4X indoor, dust and sprayed water protection		
Environmental conditions			
Temperature			
Operation	Without Rittal housing Mounting orientation 0°: 0 to 50°C Mounting orientations to -45° display above: 0 to 50°C Mounting orientations to +45° display below: 0 to 50°C		
Storage	With Rittal housing Mounting orientation 0°: 0 to 50°C Mounting orientations to -45° display above: 0 to 45°C Mounting orientations to +45° display below: 0 to 45°C		
Transport	-30 to 70°C		
Vibration			
Operation (continuous)	2 to 9 Hz: 1.75 mm amplitude / 9 to 200 Hz: 0.5 g		
Operation (occasional)	2 to 9 Hz: 3.5 mm amplitude / 9 to 200 Hz: 1 g		
Storage	2 to 8 Hz: 7.5 mm amplitude / 8 to 200 Hz: 2 g / 200 to 500 Hz: 4 g		
Transport	2 to 8 Hz: 7.5 mm amplitude / 8 to 200 Hz: 2 g / 200 to 500 Hz: 4 g		
Shock			
Operation	15 g, 11 ms		
Storage	30 g, 15 ms		
Transport	30 g, 15 ms		
Altitude			
Operation	Max. 3000 m ⁶⁾		
Mechanical characteristics			
Housing			
Material	Metal		
Paint	Similar to Pantone 432CV		
Front ⁷⁾			
Frame	Naturally anodized aluminum		
Design	Gray		
Panel overlay			
Material	Polyester		
Light background	Similar to Pantone 427CV		
Dark gray border around display	Similar to Pantone 432CV		
Dark gray keys	Similar to Pantone 431CV		
Orange keys	Similar to Pantone 151CV		
Color slide-in labels	Similar to Pantone 429CV		
Gasket	Flat gasket around display front		
Dimensions			
Width	323 mm		
Height	358 mm		
Depth	55 mm		
Weight	Approx. 3600 g		

Table 18: 5AP981.1043-01, 5AP981.1043-01, 5AP981.1043-01, 5AP981.1043-01 - Technical data

- 1) USB devices can only be connected to the Automation Panel directly (i.e. without a hub).
- 2) Depends on the transmission technology, the transfer distance and the Automation Panel Link insert card being used.
- 3) At an ambient temperature of 25°C. Reducing the brightness by 50% can result in an approximately 50% increase in the half-brightness time.
- 4) Touch screen drivers for approved operating systems are available in the Downloads section of the B&R website.

- 5) The specified value applies to Automation Panel systems with an inserted Automation Panel Link card.
- 6) The maximum ambient temperature is typically derated by 1°C per 1000 meters (starting at 500 meters above sea level).
- 7) There may be visible deviations in the color and surface appearance depending on the process or batch.

3.1.1.5.4 Temperature humidity diagram

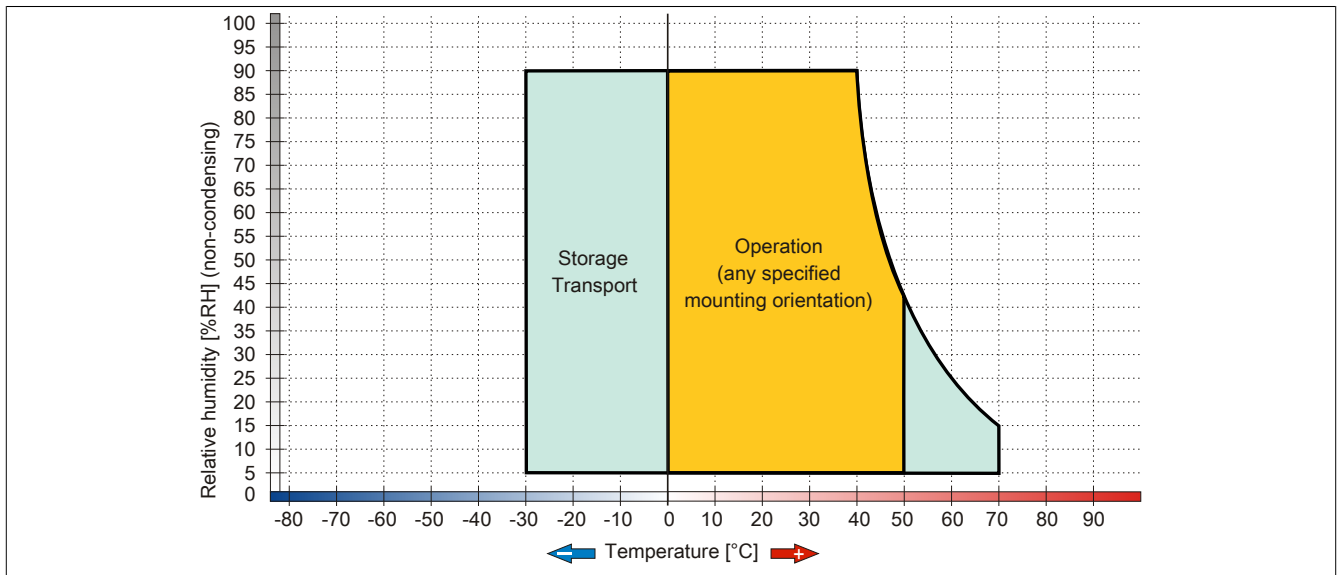

Figure 32: 5AP981.1043-01 - Temperature humidity diagram

3.1.1.5.5 Dimensions

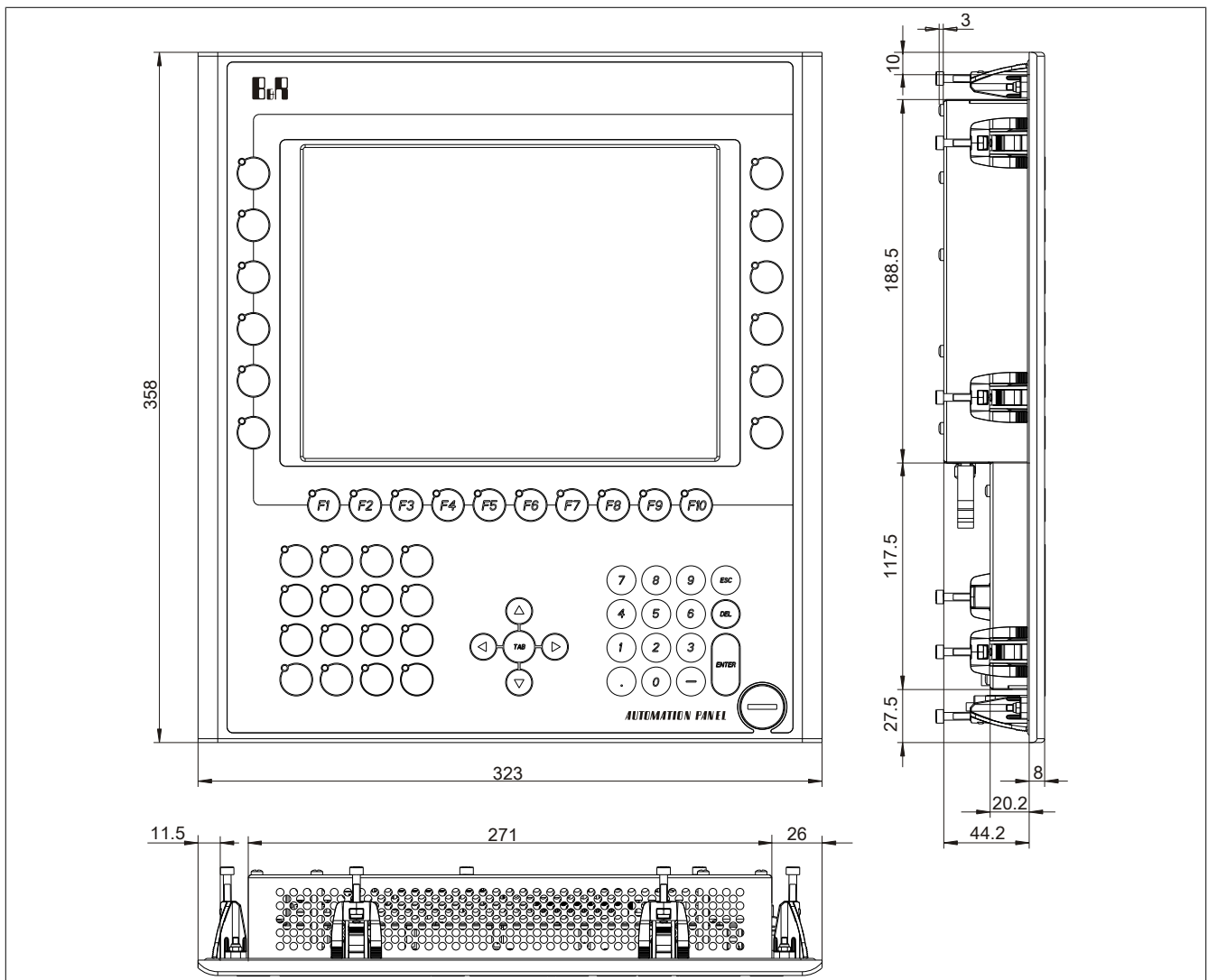

Figure 33: 5AP981.1043-01 - Dimensions

3.1.1.5.6 Cutout installation

The Automation Panel can be installed in a wall cutout using the pre-installed clamping blocks. To do so, it is necessary to make a cutout that corresponds to the following diagram.

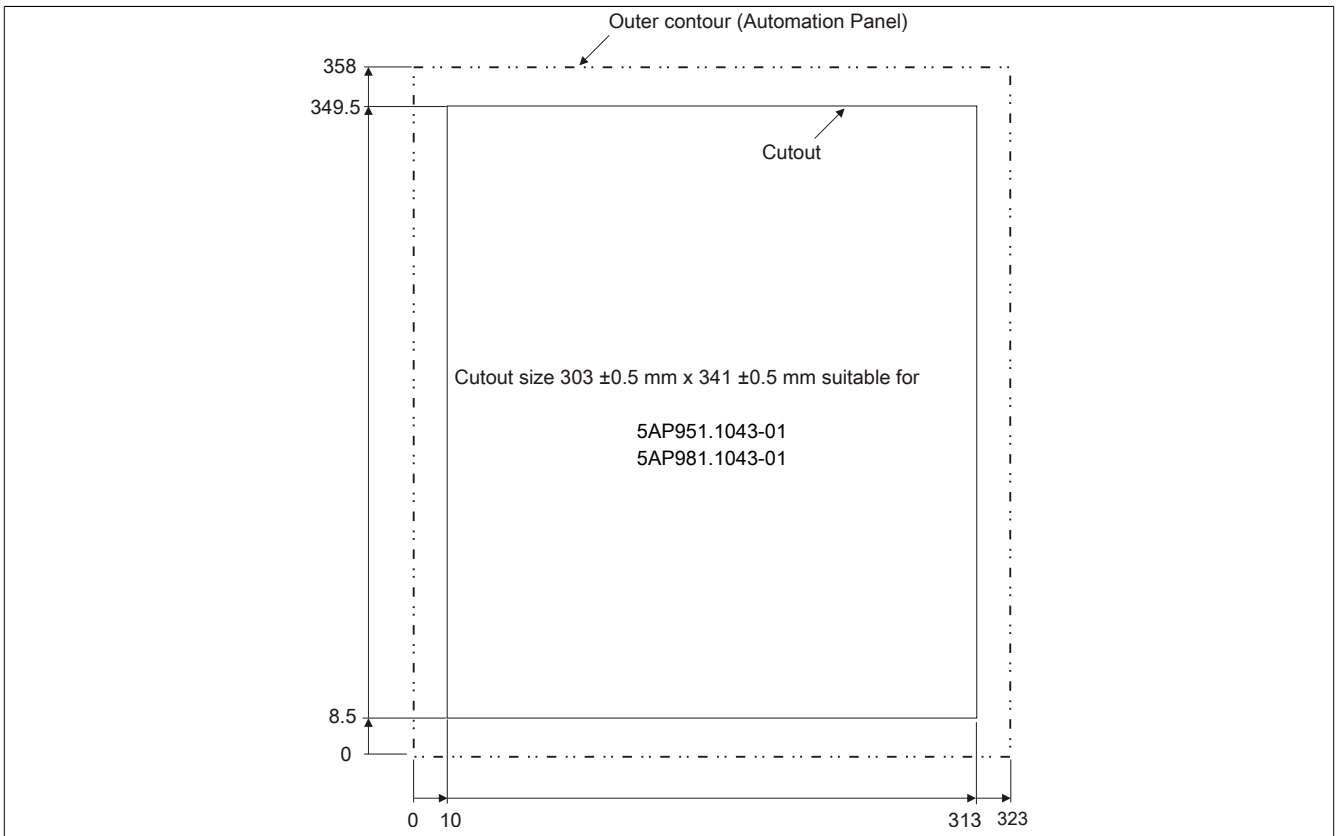

Figure 34: 5AP981.1043-01 - Cutout installation

For additional information regarding installation and mounting orientation, see "Installation" on page 109.

3.1.1.6 5AP982.1043-01

3.1.1.6.1 General information

- 10.4" VGA color TFT display
- Analog resistive touch screen
- Function and system keys
- Small installation depth
- Fan-free operation
- Can be upgraded with Display Link cards or PPC300

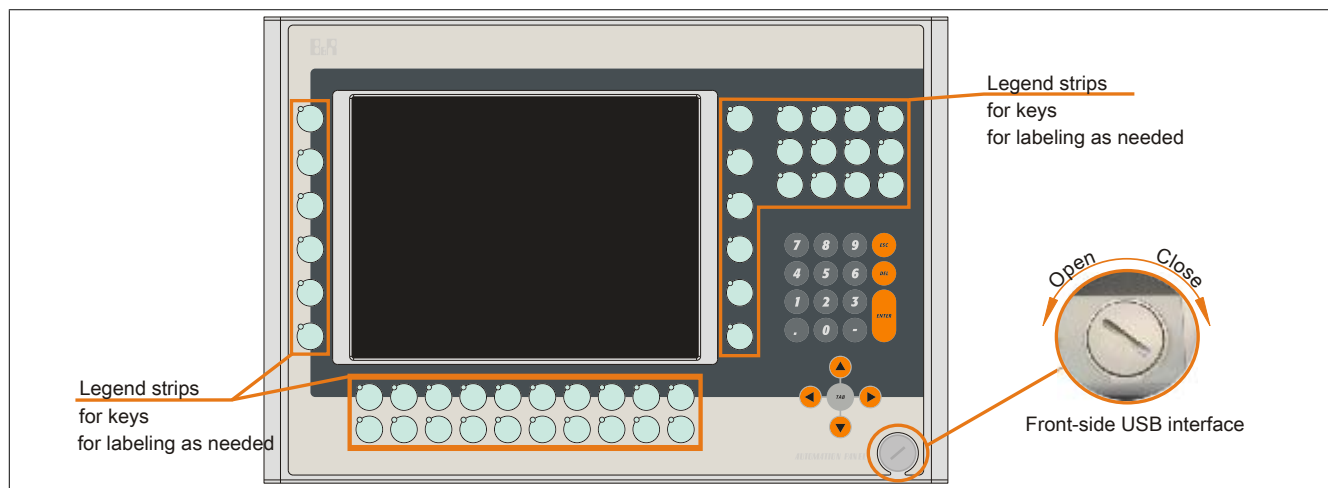

Figure 35: 5AP982.1043-01 - Front view

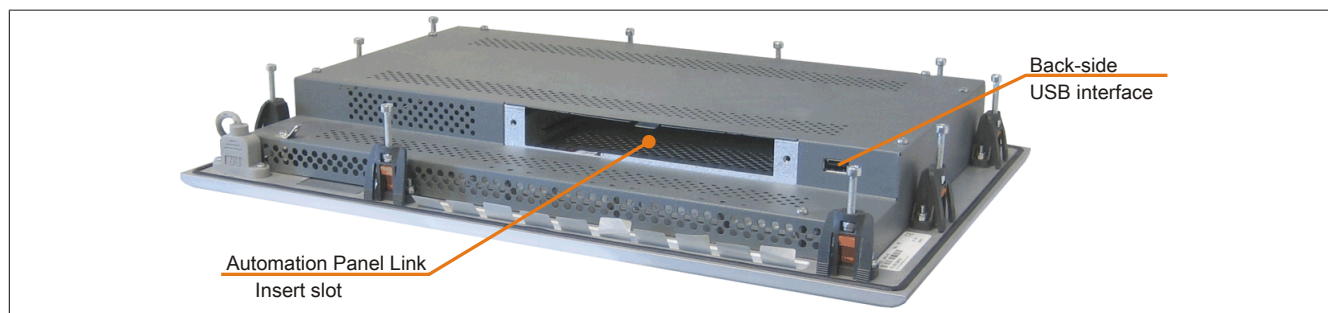

Figure 36: 5AP982.1043-01 - Rear view

3.1.1.6.2 Order data

Model number	Short description	Figure
	Display units	
5AP982.1043-01	Automation Panel AP982; 10.4" VGA color TFT screen (resistive); 44 function keys and 20 system keys; 2 USB 2.0 interfaces; insert for Automation Panel Link; IP65 protection (from front). 24 VDC.	
	Required accessories	
	Display links	
5DLDVI.1000-01	Automation Panel Link DVI receiver; connections for DVI-D, RS232 and USB 2.0 (Type B); 24 VDC (order screw clamp 0TB103.9 or cage clamp 0TB103.91 separately).	
5DLS3.1000-00	Automation Panel Link SDL3 receiver - For Automation Panel 920/98x	
5DLSL.1000-00	Automation Panel Link SDL receiver; connection for SDL In; transmission of display, touch screen, USB 1.1, matrix key and service data; 24 VDC (order screw clamp 0TB103.9 or cage clamp 0TB103.91 separately).	
5DLSL.1000-01	Automation Panel Link SDL transceiver; connections for SDL In and SDL Out; transmission of display, touch screen, USB 1.1, matrix key and service data; 24 VDC (order screw clamp 0TB103.9 or cage clamp 0TB103.91 separately).	
	Terminal blocks	
0TB103.9	Connector 24 VDC - 3-pin female - Screw clamps 3.31 mm ²	
0TB103.91	Connector 24 VDC - 3-pin female - Cage clamps 3.31 mm ²	

Table 19: 5AP982.1043-01 - Order data

Model number	Short description	Figure
	Optional accessories	
	Accessories	
5AC900.104X-04	Legend Strips Template 10,4" for Automation Panel 5AP952.1043-01 and 5AP982.1043-01; for 1 device.	
	Panel PC 300 insert cards	
5PC310.L800-00	Panel PC 300 insert card for the Automation Panel 900; 256 MB SDRAM; CompactFlash slot (Type I); 2x ETH 10/100; RS232; USB 2.0 (via integrated USB 2.0 interfaces on the Automation Panel); battery; 24 VDC (order screw clamp 0TB103.9 or cage clamp 0TB103.91 separately)	
5PC310.L800-01	Panel PC 300 insert card for the Automation Panel 900; 512 MB SDRAM; CompactFlash slot (Type I); 2x ETH 10/100; RS232; USB 2.0 (via integrated USB 2.0 interfaces on the Automation Panel); battery; 24 VDC (order screw clamp 0TB103.9 or cage clamp 0TB103.91 separately)	

Table 19: 5AP982.1043-01 - Order data

3.1.1.6.3 Technical data

Product ID	5AP982.1043-01			
Revision	C0	D0	G0	H0
General information				
B&R ID code	0x1D5A			
Certification				
CE	Yes			
cULus	Yes			
GOST-R	Yes			
Interfaces				
USB ¹⁾				
Quantity	2			
Type	USB 2.0 ²⁾			
Execution	Type A			
Transfer rate	Low speed (1.5 Mbit/s), full speed (12 Mbit/s), high speed (480 Mbit/s)			
Current load	Max. 500 mA per connection			
Display				
Type	TFT color			
Display size	10.4" (264 mm)			
Colors	262144			16 million
Resolution	VGA, 640 x 480 pixels			
Contrast	300:1			700:1
Viewing angles				
Horizontal	Direction R = 70° / Direction L = 70°			Direction R = 80° / Direction L = 80°
Vertical	Direction U = 40° / Direction D = 70°			Direction U = 80° / Direction D = 60°
Backlight				
Type	CCFL			LED
Brightness	350 cd/m ²			450 cd/m ²
Half-brightness time ³⁾	50,000 h			
Filter glass				
Transmittance	-			
Coating	-			
Touch screen ⁴⁾				
Type	Elo AccuTouch		AMT	
Technology	Analog, resistive			
Controller	Elo, serial, 12-bit			
Transmittance	80% ±5%		81% ±3%	
Keys				
Function keys	44 with LED (yellow)			
Soft keys	No			
System keys	Numeric keys, cursor block			
Service life	>1,000,000 actuations at 1 ±0.3N to 3 ±0.3 N actuating force			
LED brightness				
Yellow	Typ. 12 mcd			
Inserts				
Compatible installation for PPC300 insert	No	Yes		
Electrical characteristics				
Nominal voltage	24 VDC ±25%			
Nominal current	Max. 3.2 A ⁵⁾			
Starting current	Typ. 6 A, max. 30 A for <300 µs			
Power consumption	Typ. 10 W (without LED), max. 14 W or 21 W with USB (without insert)			
Electrical isolation	Yes			

Table 20: 5AP982.1043-01, 5AP982.1043-01, 5AP982.1043-01, 5AP982.1043-01 - Technical data

Product ID	5AP982.1043-01
Operating conditions	
EN 60529 protection	Back: IP20 (only with an inserted Automation Panel Link card) Front: IP65 / NEMA 250 type 4X indoor, dust and sprayed water protection
Environmental conditions	
Temperature Operation	Without Rittal housing Mounting orientation 0°: 0 to 50°C Mounting orientations to -45° display above: 0 to 50°C Mounting orientations to +45° display below: 0 to 50°C
Storage Transport	With Rittal housing Mounting orientation 0°: 0 to 50°C Mounting orientations to -45° display above: 0 to 45°C Mounting orientations to +45° display below: 0 to 45°C -30 to 70°C -30 to 70°C
Vibration Operation (continuous) Operation (occasional) Storage Transport	2 to 9 Hz: 1.75 mm amplitude / 9 to 200 Hz: 0.5 g 2 to 9 Hz: 3.5 mm amplitude / 9 to 200 Hz: 1 g 2 to 8 Hz: 7.5 mm amplitude / 8 to 200 Hz: 2 g / 200 to 500 Hz: 4 g 2 to 8 Hz: 7.5 mm amplitude / 8 to 200 Hz: 2 g / 200 to 500 Hz: 4 g
Shock Operation Storage Transport	15 g, 11 ms 30 g, 15 ms 30 g, 15 ms
Altitude Operation	Max. 3000 m ⁶⁾
Mechanical characteristics	
Housing Material Paint	Metal Similar to Pantone 432CV
Front ⁷⁾ Frame Design Panel overlay Material Light background Dark gray border around display Dark gray keys Orange keys Color slide-in labels Gasket	Naturally anodized aluminum Gray Polyester Similar to Pantone 427CV Similar to Pantone 432CV Similar to Pantone 431CV Similar to Pantone 151CV Similar to Pantone 429CV Flat gasket around display front
Dimensions Width Height Depth	423 mm 288 mm 55 mm
Weight	Approx. 3900 g

Table 20: 5AP982.1043-01, 5AP982.1043-01, 5AP982.1043-01, 5AP982.1043-01 - Technical data

- 1) USB devices can only be connected to the Automation Panel directly (i.e. without a hub).
- 2) Depends on the transmission technology, the transfer distance and the Automation Panel Link insert card being used.
- 3) At an ambient temperature of 25°C. Reducing the brightness by 50% can result in an approximately 50% increase in the half-brightness time.
- 4) Touch screen drivers for approved operating systems are available in the Downloads section of the B&R website.
- 5) The specified value applies to Automation Panel systems with an inserted Automation Panel Link card.
- 6) The maximum ambient temperature is typically derated by 1°C per 1000 meters (starting at 500 meters above sea level).
- 7) There may be visible deviations in the color and surface appearance depending on the process or batch.

3.1.1.6.4 Temperature humidity diagram

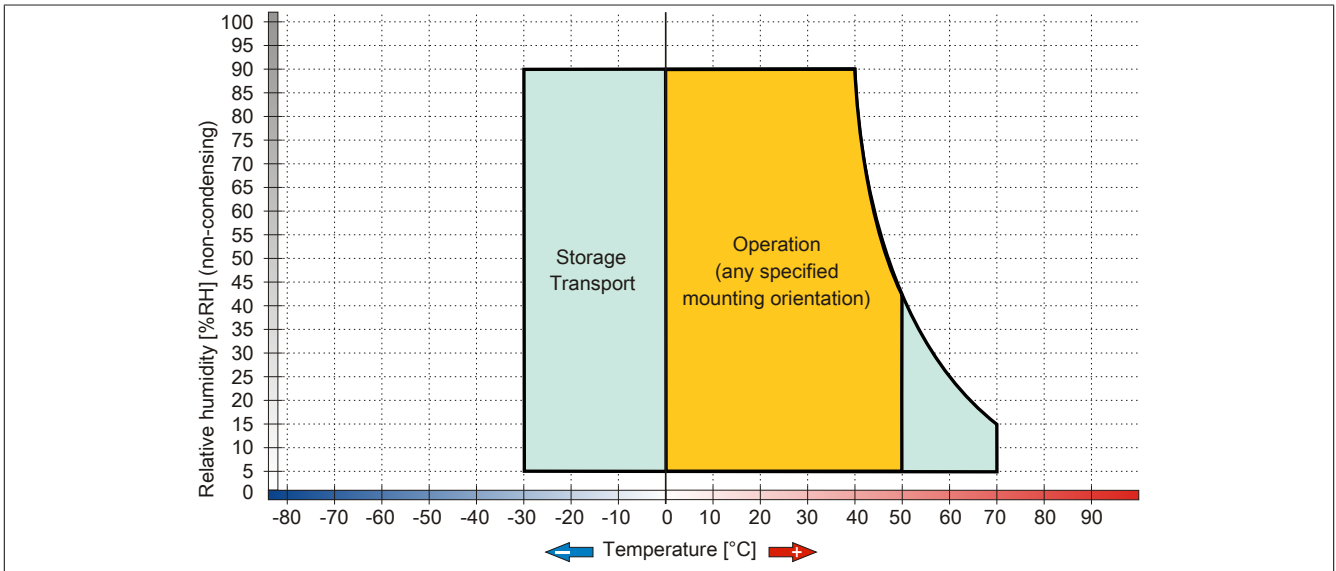

Figure 37: 5AP982.1043-01 - Temperature humidity diagram

3.1.1.6.5 Dimensions

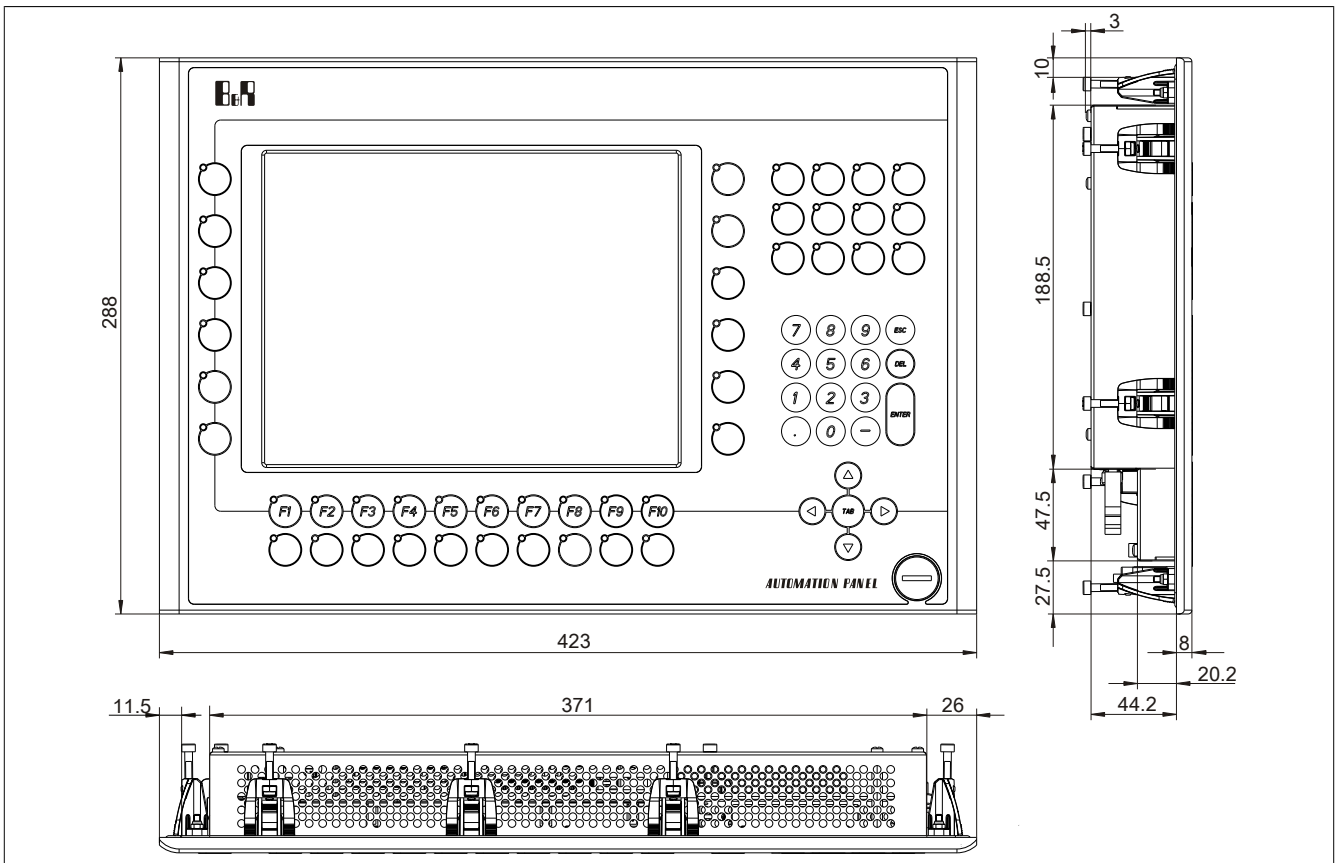

Figure 38: 5AP982.1043-01 - Dimensions

3.1.1.6.6 Cutout installation

The Automation Panel can be installed in a wall cutout using the pre-installed clamping blocks. To do so, it is necessary to make a cutout that corresponds to the following diagram.

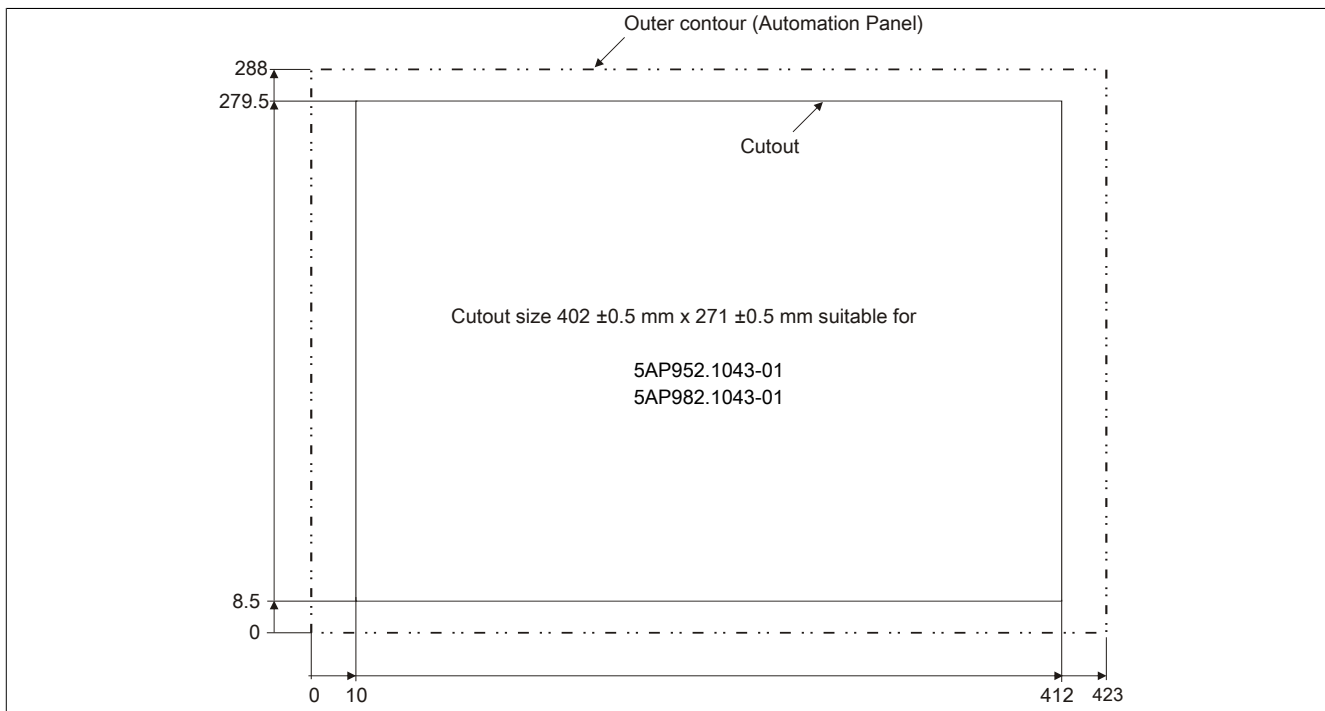

Figure 39: 5AP982.1043-01 - Cutout installation

For additional information regarding installation and mounting orientation, see "Installation" on page 109.

3.1.2 Automation Panel 12.1" SVGA

3.1.2.1 5AP920.1214-01

3.1.2.1.1 General information

- 12.1" SVGA color TFT display
- Analog resistive touch screen
- Small installation depth
- Fan-free operation
- Can be upgraded with Display Link cards or PPC300

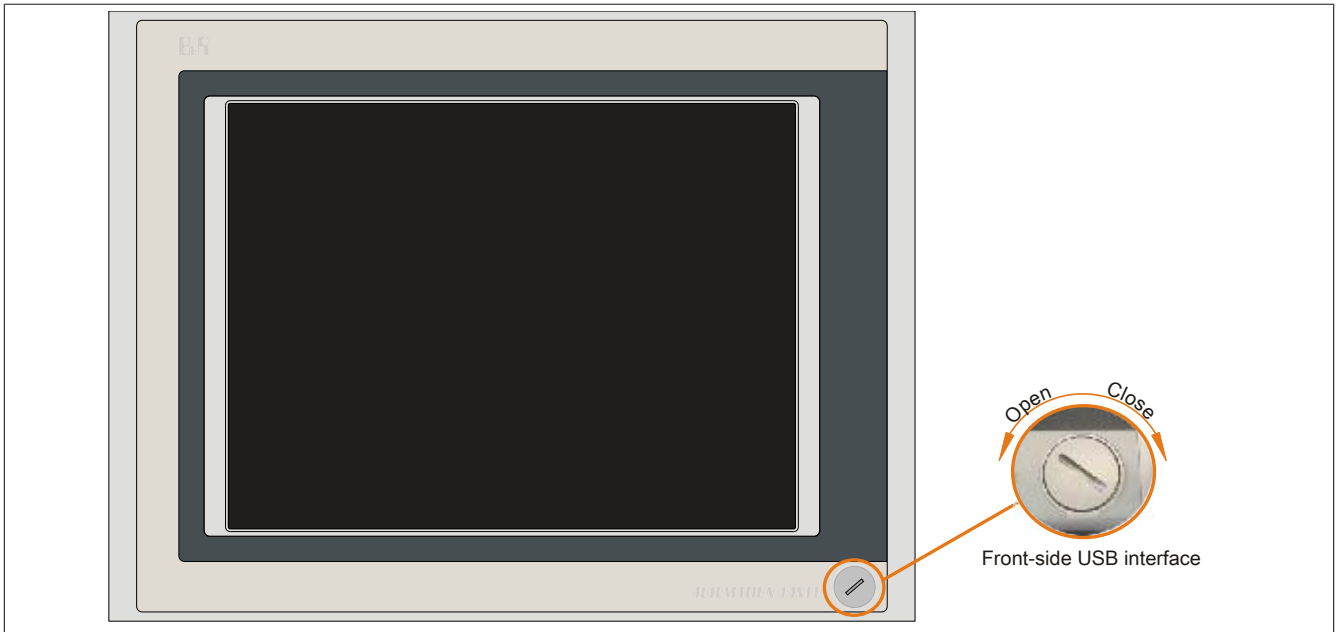

Figure 40: 5AP920.1214-01 - Front view



Figure 41: 5AP920.1214-01 - Rear view

3.1.2.1.2 Order data

Model number	Short description	Figure
	Display units	
5AP920.1214-01	Automation Panel AP920 12.1" TFT - 800 x 600 pixels (4:3) - Single-touch (analog resistive) - Landscape format - IP65 protection (front)	
	Required accessories	
	Display links	
5DLDVI.1000-01	Automation Panel Link DVI receiver; connections for DVI-D, RS232 and USB 2.0 (Type B); 24 VDC (order screw clamp 0TB103.9 or cage clamp 0TB103.91 separately).	
5DLS3.1000-00	Automation Panel Link SDL3 receiver - For Automation Panel 920/98x	
5DLSL.1000-00	Automation Panel Link SDL receiver; connection for SDL In; transmission of display, touch screen, USB 1.1, matrix key and service data; 24 VDC (order screw clamp 0TB103.9 or cage clamp 0TB103.91 separately).	

Table 21: 5AP920.1214-01 - Order data

Technical data • Individual components

Model number	Short description	Figure
5DLSDL.1000-01	Automation Panel Link SDL transceiver; connections for SDL In and SDL Out; transmission of display, touch screen, USB 1.1, matrix key and service data; 24 VDC (order screw clamp 0TB103.9 or cage clamp 0TB103.91 separately).	
	Terminal blocks	
0TB103.9	Connector 24 VDC - 3-pin female - Screw clamps 3.31 mm ²	
0TB103.91	Connector 24 VDC - 3-pin female - Cage clamps 3.31 mm ²	
	Optional accessories	
	Panel PC 300 insert cards	
5PC310.L800-00	Panel PC 300 insert card for the Automation Panel 900; 256 MB SDRAM; CompactFlash slot (Type I); 2x ETH 10/100; RS232; USB 2.0 (via integrated USB 2.0 interfaces on the Automation Panel); battery; 24 VDC (order screw clamp 0TB103.9 or cage clamp 0TB103.91 separately)	
5PC310.L800-01	Panel PC 300 insert card for the Automation Panel 900; 512 MB SDRAM; CompactFlash slot (Type I); 2x ETH 10/100; RS232; USB 2.0 (via integrated USB 2.0 interfaces on the Automation Panel); battery; 24 VDC (order screw clamp 0TB103.9 or cage clamp 0TB103.91 separately)	

Table 21: 5AP920.1214-01 - Order data

3.1.2.1.3 Technical data

Product ID	5AP920.1214-01		
Revision	E0	F0	G0
General information			
B&R ID code	0x2AE7		
Certification			
CE	Yes		
cULus	Yes		
GOST-R	Yes		
Interfaces			
USB ¹⁾			
Quantity	3		
Type	USB 2.0 ²⁾		
Execution	Type A		
Transfer rate	Low speed (1.5 Mbit/s), full speed (12 Mbit/s), high speed (480 Mbit/s)		
Current load	Max. 500mA per connection		
Display			
Type	Color TFT		
Display size	12.1" (307 mm)		
Colors	262144		
Resolution	SVGA, 800 x 600 pixels		
Contrast	300:1		800:1
Viewing angles			
Horizontal	Direction R = 70° / Direction L = 70°		Direction R = 80° / Direction L = 80°
Vertical	Direction U = 50° / direction D = 60°		Direction U = 60° / Direction D = 80°
Backlight			
Type	CCFL		LED
Brightness	350 cd/m ²		450 cd/m ²
Half-brightness time ³⁾	50,000 h		
Filter glass			
Transmittance	-		
Coating	-		
Touch screen ⁴⁾			
Type	Elo AccuTouch		AMT
Technology		Analog, resistive	
Controller		Elo, serial, 12-bit	
Transmittance	80% ±5%		81% ±3%
Keys			
Function keys	No		
Soft keys	No		
System keys	No		
Service life	-		
LED brightness	-		
LED brightness Yellow	-		
Inserts			
Compatible installation for PPC300 insert	Yes		
Electrical characteristics			
Nominal voltage	24 VDC ±25%		
Nominal current	Max. 3.2 A ⁵⁾		

Table 22: 5AP920.1214-01, 5AP920.1214-01, 5AP920.1214-01 - Technical data

Product ID	5AP920.1214-01
Starting current	Typ. 6 A, max. 30 A for < 300 µs
Power consumption	Typ. 12 W, max. 15 W or 21 W with USB (without insert)
Electrical isolation	Yes
Operating conditions	
EN 60529 protection	IP20 back side (only with Automation Panel Link card inserted) IP65 / NEMA 250 type 4X indoor, dust and sprayed water protection (front side)
Environmental conditions	
Temperature Operation	Without Rittal housing Mounting orientation 0°: 0 to 50°C Mounting orientations to -45° display above: 0 to 50°C Mounting orientations to +45° display below: 0 to 50°C
Storage Transport	-30 to 70°C -30 to 70°C
Vibration Operation (continuous) Operation (occasional) Storage Transport	2 to 9 Hz: 1.75 mm amplitude / 9 to 200 Hz: 0.5 g 2 to 9 Hz: 3.5 mm amplitude / 9 to 200 Hz: 1 g 2 to 8 Hz: 7.5 mm amplitude / 8 to 200 Hz: 2 g / 200 to 500 Hz: 4 g 2 to 8 Hz: 7.5 mm amplitude / 8 to 200 Hz: 2 g / 200 to 500 Hz: 4 g
Shock Operation Storage Transport	15 g, 11 ms 30 g, 15 ms 30 g, 15 ms
Altitude Operation	Max. 3000 m ⁶⁾
Mechanical characteristics	
Housing Material Paint	Metal Similar to Pantone432CV
Front ⁷⁾ Frame Design Panel overlay Material Light background Dark gray border around display Gasket	Naturally anodized aluminum Gray Polyester Similar to Pantone 427CV Similar to Pantone432CV Flat gasket around display front
Dimensions Width Height Depth	362 mm 284 mm 54 mm
Weight	Approx. 3400 g

Table 22: 5AP920.1214-01, 5AP920.1214-01, 5AP920.1214-01 - Technical data

- 1) USB devices can only be connected directly to the Automation Panel (without a hub).
- 2) Depends on the transfer technology, the transfer distance and the Automation Panel Link insert card used.
- 3) At 25°C ambient temperature. Reducing the brightness by 50% can result in an approximate 50% increase of the half-brightness time.
- 4) Touch screen drivers can be downloaded from the download area on the B&R homepage (www.br-automation.com).
- 5) The listed value applies to the Automation Panel device with an inserted Automation Panel Link card.
- 6) Derating the maximum ambient temperature - typically 1°C per 1000 meters (from 500 meters above sea level).
- 7) Depending on the process or batch, there may be visible deviations in the color and surface structure.

3.1.2.1.4 Temperature humidity diagram

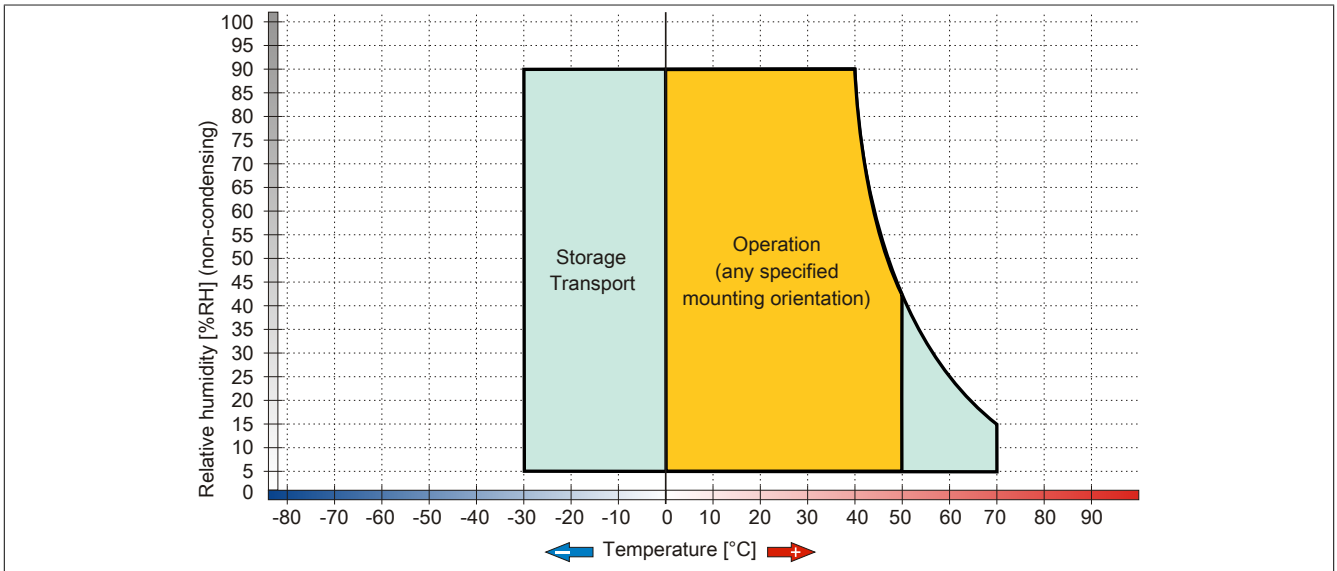

Figure 42: 5AP920.1214-01 - Temperature humidity diagram

3.1.2.1.5 Dimensions

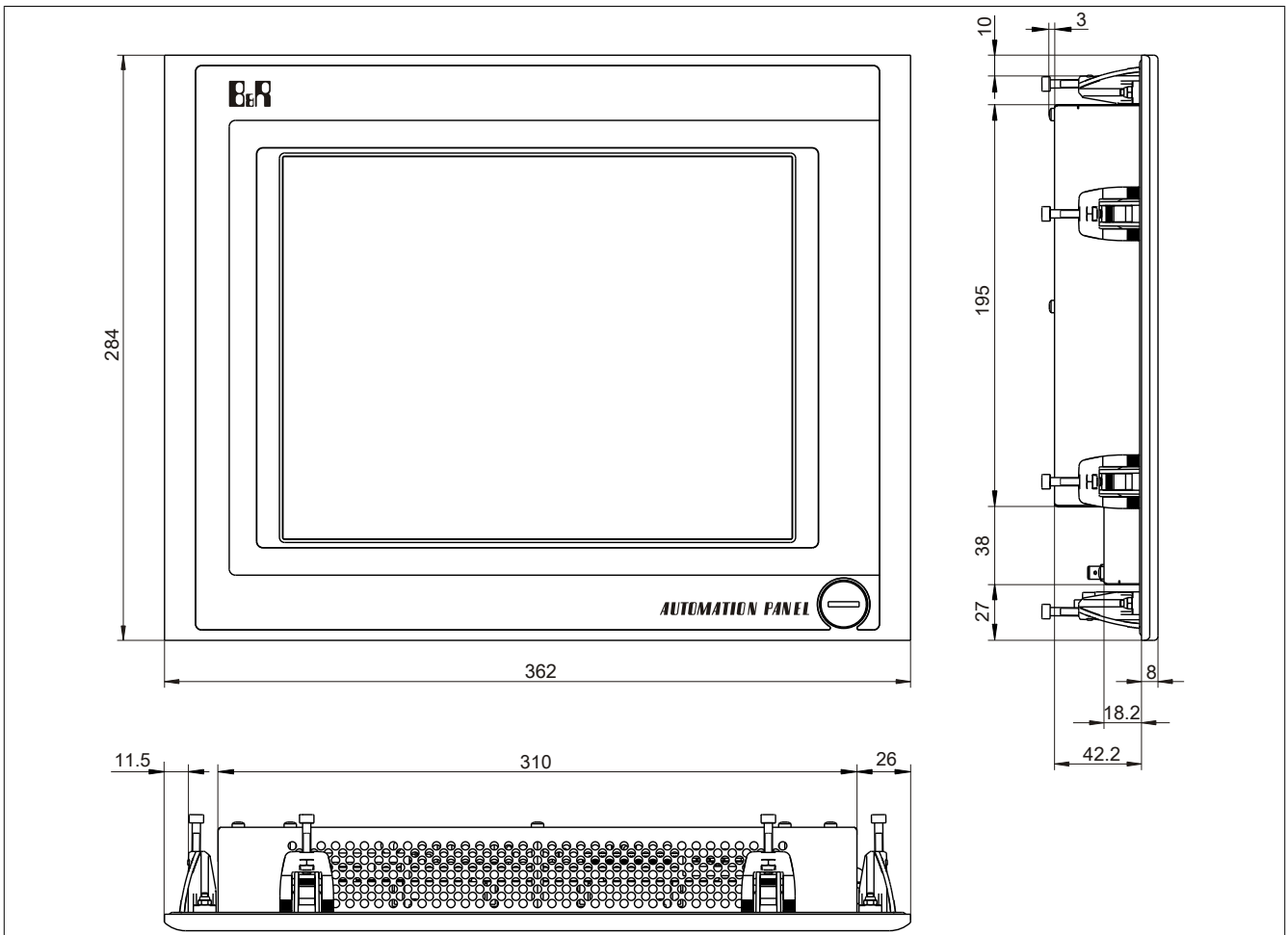

Figure 43: 5AP920.1214-01 - Dimensions

3.1.2.1.6 Cutout installation

The Automation Panel can be installed in a wall cutout using the pre-installed clamping blocks. To do so, it is necessary to make a cutout that corresponds to the following diagram.

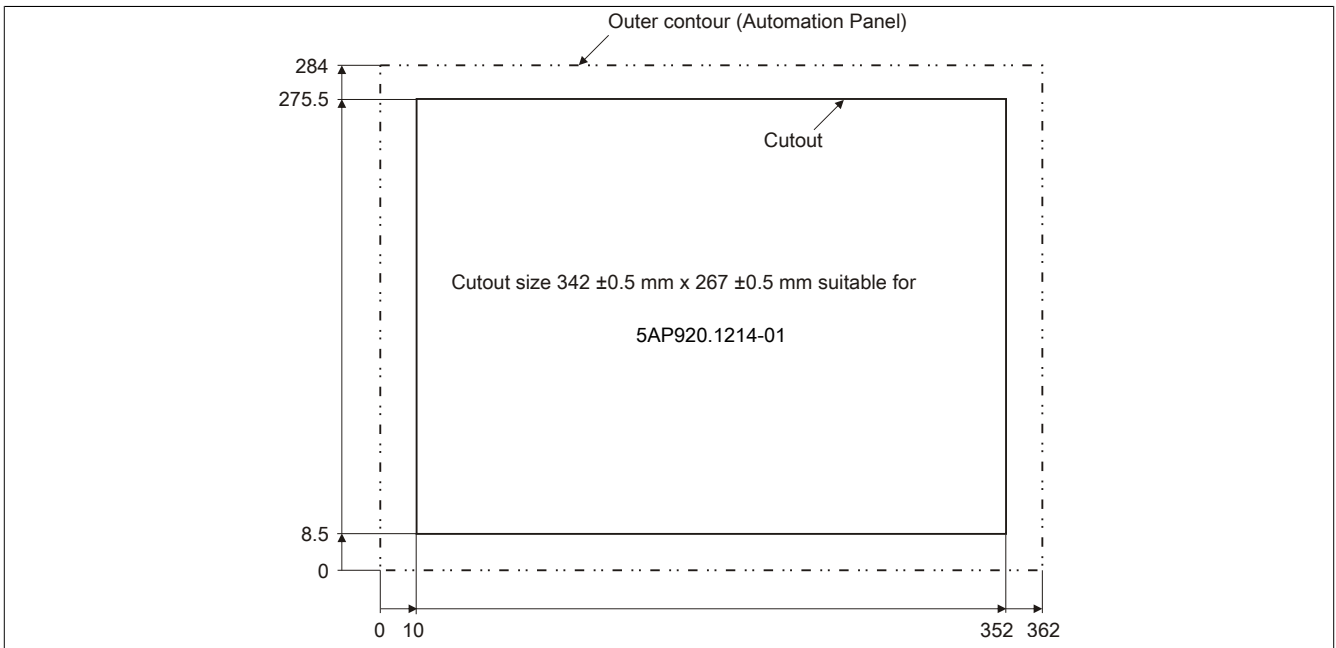

Figure 44: 5AP920.1214-01 - Cutout installation

For additional information regarding installation and mounting orientation, see "Installation" on page 109.

3.1.3 Automation Panel 15" XGA

3.1.3.1 5AP920.1505-01

3.1.3.1.1 General information

- 15" XGA color TFT display
- Analog resistive touch screen
- Small installation depth
- Fan-free operation
- Can be upgraded with Display Link cards or PPC300

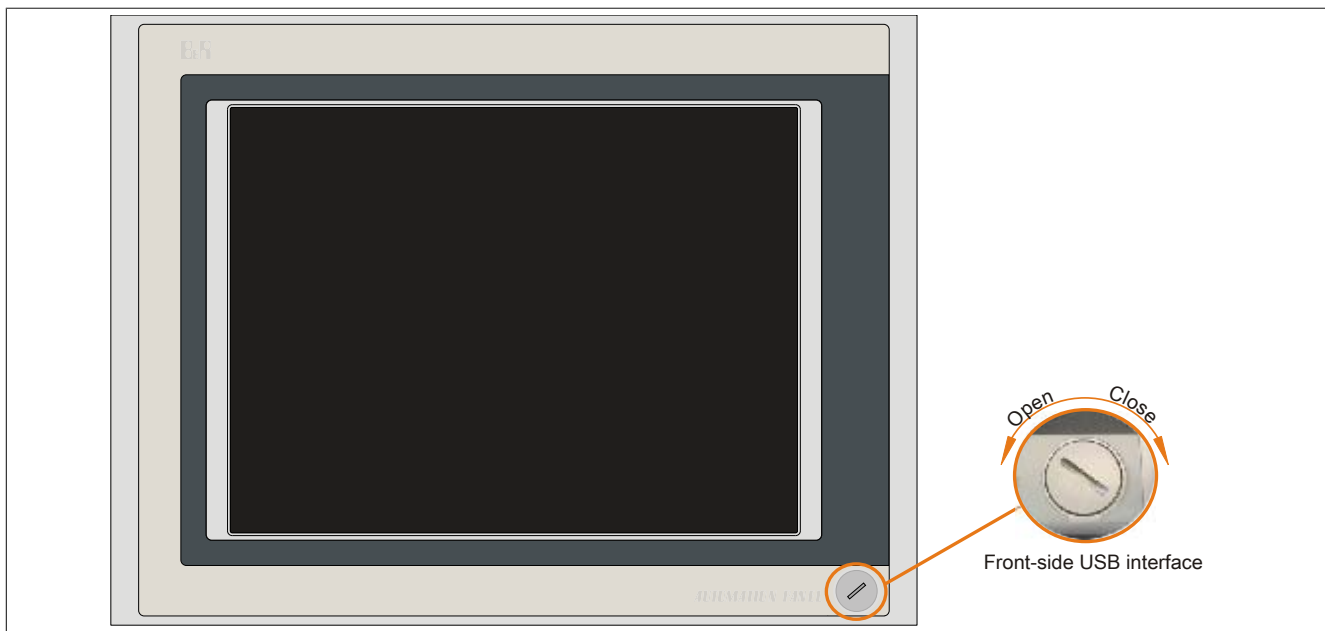

Figure 45: 5AP920.1505-01 - Front view

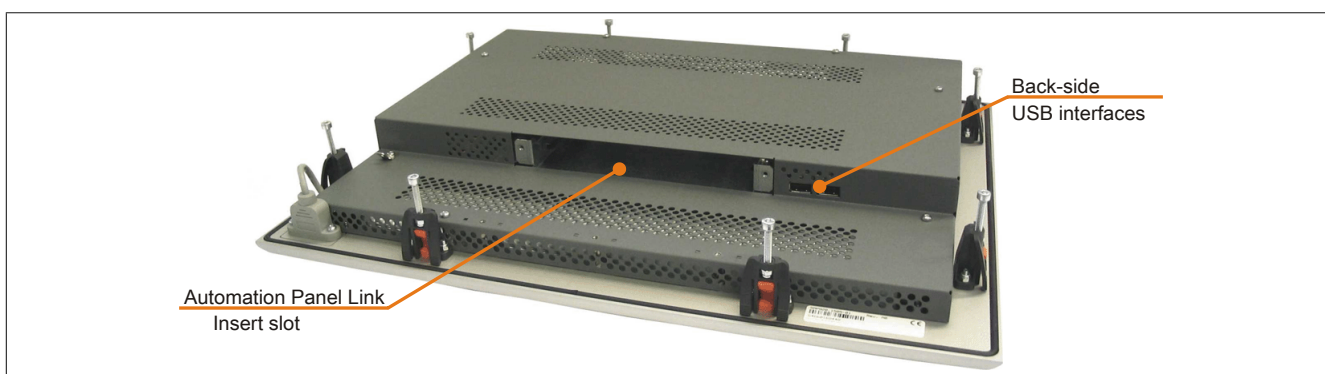

Figure 46: 5AP920.1505-01 - Rear view

3.1.3.1.2 Order data

Model number	Short description	Figure
	Display units	
5AP920.1505-01	Automation Panel AP920; 15" XGA color TFT display with touch screen (resistive); 3 USB 2.0 interfaces; insert for Automation Panel Link; IP65 protection (from front). 24 VDC.	
	Required accessories	
	Display links	
5DLDVI.1000-01	Automation Panel Link DVI receiver; connections for DVI-D, RS232 and USB 2.0 (Type B); 24 VDC (order screw clamp 0TB103.9 or cage clamp 0TB103.91 separately).	
5DLS3.1000-00	Automation Panel Link SDL3 receiver - For Automation Panel 920/98x	
5DLSL.1000-00	Automation Panel Link SDL receiver; connection for SDL In; transmission of display, touch screen, USB 1.1, matrix key and service data; 24 VDC (order screw clamp 0TB103.9 or cage clamp 0TB103.91 separately).	

Table 23: 5AP920.1505-01 - Order data

Model number	Short description	Figure
5DLSDL.1000-01	Automation Panel Link SDL transceiver; connections for SDL In and SDL Out; transmission of display, touch screen, USB 1.1, matrix key and service data; 24 VDC (order screw clamp 0TB103.9 or cage clamp 0TB103.91 separately).	
	Terminal blocks	
0TB103.9	Connector 24 VDC - 3-pin female - Screw clamps 3.31 mm ²	
0TB103.91	Connector 24 VDC - 3-pin female - Cage clamps 3.31 mm ²	
	Optional accessories	
	Panel PC 300 insert cards	
5PC310.L800-00	Panel PC 300 insert card for the Automation Panel 900; 256 MB SDRAM; CompactFlash slot (Type I); 2x ETH 10/100; RS232; USB 2.0 (via integrated USB 2.0 interfaces on the Automation Panel); battery; 24 VDC (order screw clamp 0TB103.9 or cage clamp 0TB103.91 separately)	
5PC310.L800-01	Panel PC 300 insert card for the Automation Panel 900; 512 MB SDRAM; CompactFlash slot (Type I); 2x ETH 10/100; RS232; USB 2.0 (via integrated USB 2.0 interfaces on the Automation Panel); battery; 24 VDC (order screw clamp 0TB103.9 or cage clamp 0TB103.91 separately)	

Table 23: 5AP920.1505-01 - Order data

3.1.3.1.3 Technical data

Product ID	5AP920.1505-01		
Revision	I0	J0	M0
General information			
B&R ID code	0x1942		
Certification			
CE	Yes		
cULus	Yes		
GOST-R	Yes		
GL	Yes ¹⁾		
Interfaces			
USB ²⁾			
Quantity	3		
Type	USB 2.0 ³⁾		
Execution	Type A		
Transfer rate	Low speed (1.5 Mbit/s), full speed (12 Mbit/s), high speed (480 Mbit/s)		
Current load	Max. 500 mA per connection		
Display			
Type	TFT color		
Display size	15" (381 mm)		
Colors	16.7 million		
Resolution	XGA, 1024 x 768 pixels		
Contrast	400:1		1000:1
Viewing angles			
Horizontal	Direction R = 85° / Direction L = 85°		
Vertical	Direction U = 85° / Direction D = 85°		
Backlight			
Type	CCFL		LED
Brightness	250 cd/m ²		350 cd/m ²
Half-brightness time ⁴⁾	50,000 h		70,000 h
Filter glass			
Transmittance	-		
Coating	-		
Touch screen ⁵⁾			
Type	Elo AccuTouch		AMT
Technology		Analog, resistive	
Controller		Elo, serial, 12-bit	
Transmittance	80% ±5%		81% ±3%
Keys			
Function keys	No		
Soft keys	No		
System keys	No		
Service life	-		
LED brightness	-		
LED brightness Yellow	-		
Inserts			
Compatible installation for PPC300 insert	Yes		
Electrical characteristics			
Nominal voltage	24 VDC ±25%		
Nominal current	Max. 3.2 A ⁶⁾		
Starting current	Typ. 6 A, max. 30 A for <300 µs		

Table 24: 5AP920.1505-01, 5AP920.1505-01, 5AP920.1505-01 - Technical data

Product ID	5AP920.1505-01
Power consumption	Typ. 24 W, max. 31 W or 41 W with USB (without insert)
Electrical isolation	Yes
Operating conditions	
EN 60529 protection	Back: IP20 (only with an inserted Automation Panel Link card) Front: IP65 / NEMA 250 type 4X indoor, dust and sprayed water protection
Environmental conditions	
Temperature Operation	Without Rittal housing Mounting orientation 0°: 0 to 50°C Mounting orientations to -45° display above: 0 to 50°C Mounting orientations to +45° display below: 0 to 45°C
Storage Transport	With Rittal housing Mounting orientation 0°: 0 to 40°C Mounting orientations to -45° display above: 0 to 40°C Mounting orientations to +45° display below: 0 to 40°C -25 to 60°C -25 to 60°C
Vibration Operation (continuous) Operation (occasional) Storage Transport	2 to 9 Hz: 1.75 mm amplitude / 9 to 200 Hz: 0.5 g 2 to 9 Hz: 3.5 mm amplitude / 9 to 200 Hz: 1 g 2 to 8 Hz: 7.5 mm amplitude / 8 to 200 Hz: 2 g / 200 to 500 Hz: 4 g 2 to 8 Hz: 7.5 mm amplitude / 8 to 200 Hz: 2 g / 200 to 500 Hz: 4 g
Shock Operation Storage Transport	15 g, 11 ms 30 g, 15 ms 30 g, 15 ms
Altitude Operation	Max. 3000 m ⁷⁾
Mechanical characteristics	
Housing Material Paint	Metal Similar to Pantone 432CV
Front ⁸⁾ Frame Design Panel overlay Material Light background Dark gray border around display Gasket	Naturally anodized aluminum Gray Polyester Similar to Pantone 427CV Similar to Pantone 432CV Flat gasket around display front
Dimensions Width Height Depth	435 mm 330 mm 54 mm
Weight	Approx. 5100 g

Table 24: 5AP920.1505-01, 5AP920.1505-01, 5AP920.1505-01 - Technical data

- 1) Yes, although applies only if all components installed within the complete system have this certification
- 2) USB devices can only be connected to the Automation Panel directly (i.e. without a hub).
- 3) Depends on the transmission technology, the transfer distance and the Automation Panel Link insert card being used.
- 4) At an ambient temperature of 25°C. Reducing the brightness by 50% can result in an approximately 50% increase in the half-brightness time.
- 5) Touch screen drivers for approved operating systems are available in the Downloads section of the B&R website.
- 6) The specified value applies to Automation Panel systems with an inserted Automation Panel Link card.
- 7) The maximum ambient temperature is typically derated by 1°C per 1000 meters (starting at 500 meters above sea level).
- 8) There may be visible deviations in the color and surface appearance depending on the process or batch.

3.1.3.1.4 Temperature humidity diagram

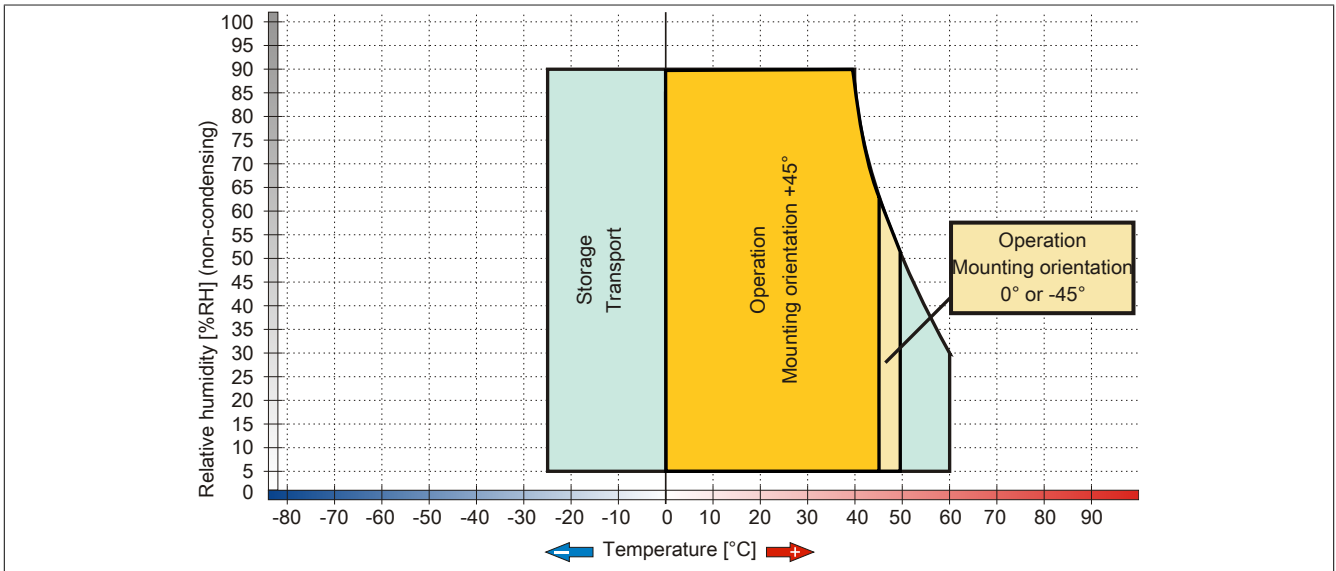

Figure 47: 5AP920.1505-01 - Temperature humidity diagram

3.1.3.1.5 Dimensions

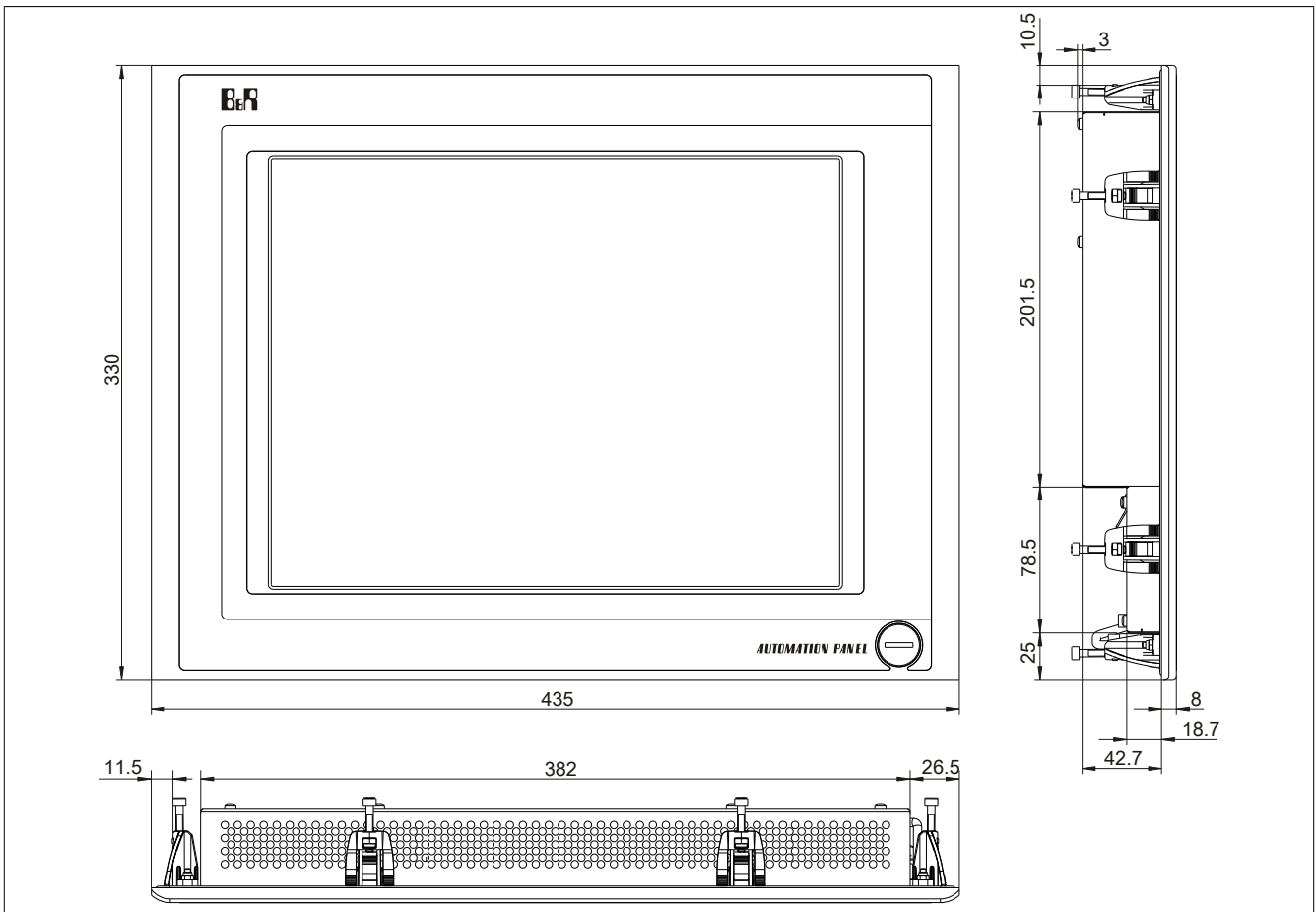

Figure 48: 5AP920.1505-01 - Dimensions

3.1.3.1.6 Cutout installation

The Automation Panel can be installed in a wall cutout using the pre-installed clamping blocks. To do so, it is necessary to make a cutout that corresponds to the following diagram.

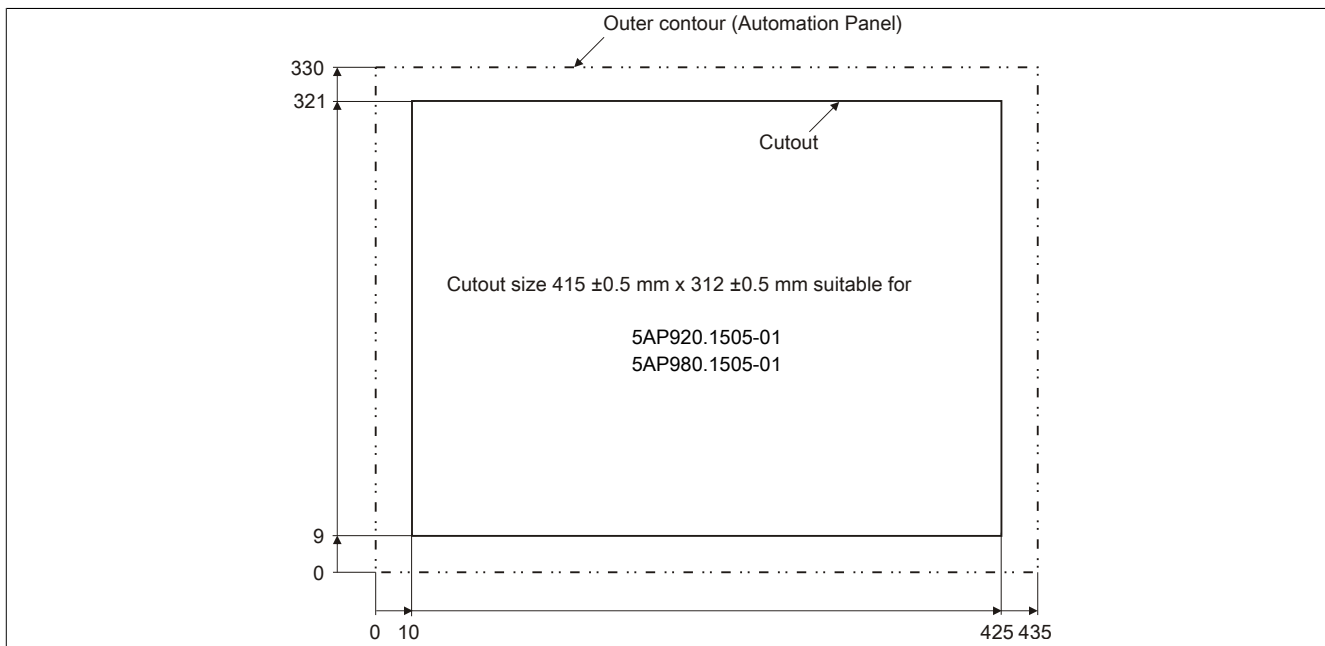

Figure 49: 5AP920.1505-01 - Cutout installation

For additional information regarding installation and mounting orientation, see "Installation" on page 109.

3.1.3.2 5AP951.1505-01

3.1.3.2.1 General information

- 15" XGA color TFT display
- Function keys, system keys and soft keys
- Small installation depth
- Fan-free operation
- Can be upgraded with Display Link cards or PPC300

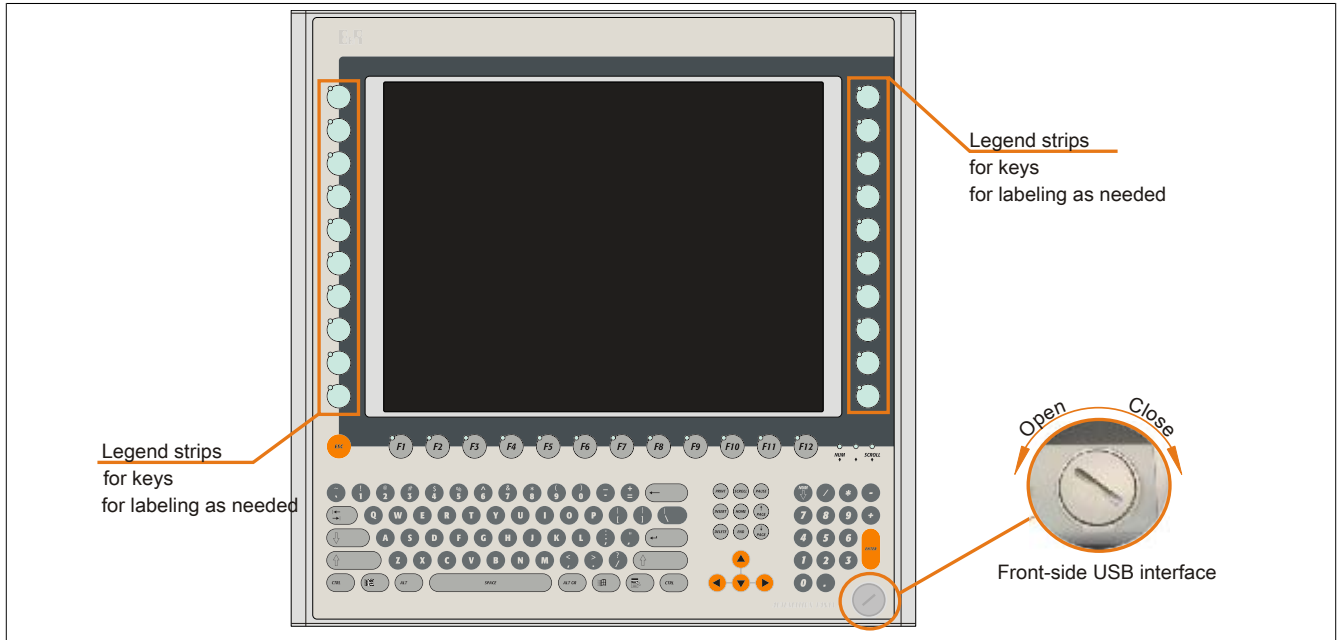

Figure 50: 5AP951.1505-01 - Front view

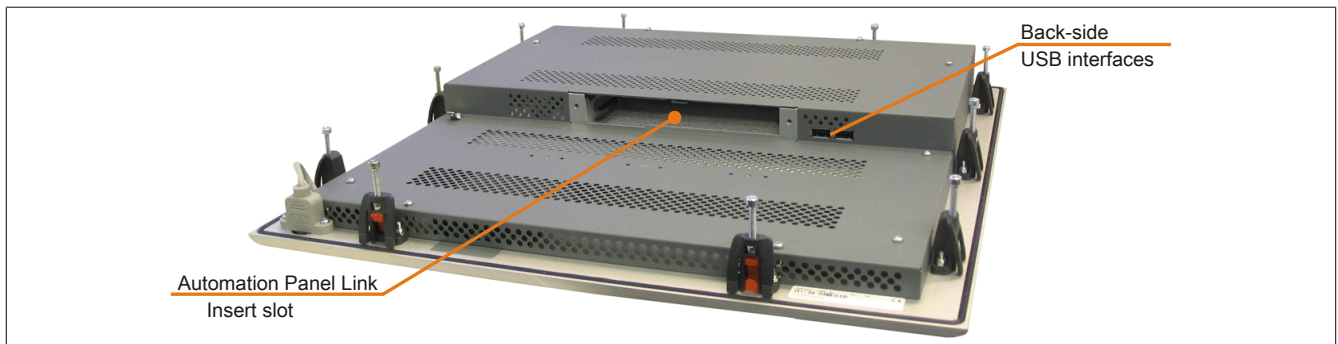

Figure 51: 5AP951.1505-01 - Rear view

3.1.3.2.2 Order data

Model number	Short description	Figure
	Display units	
5AP951.1505-01	Automation Panel AP951 15" XGA color TFT display with; 12 softkeys; 20 function keys and 92 system keys; 3 USB 2.0 interfaces; slot for Automation Panel link; IP 65 protection (front side). 24 VDC.	
	Required accessories	
	Display links	
5DLDLVI.1000-01	Automation Panel Link DVI receiver; connections for DVI-D, RS232 and USB 2.0 (Type B); 24 VDC (order screw clamp OTB103.9 or cage clamp OTB103.91 separately).	
5DLSDL.1000-00	Automation Panel Link SDL receiver; connection for SDL In; transmission of display, touch screen, USB 1.1, matrix key and service data; 24 VDC (order screw clamp OTB103.9 or cage clamp OTB103.91 separately).	
5DLSDL.1000-01	Automation Panel Link SDL transceiver; connections for SDL In and SDL Out; transmission of display, touch screen, USB 1.1, matrix key and service data; 24 VDC (order screw clamp OTB103.9 or cage clamp OTB103.91 separately).	

Table 25: 5AP951.1505-01 - Order data

Model number	Short description	Figure
0TB103.9	Connector 24 VDC - 3-pin female - Screw clamps 3.31 mm ²	
0TB103.91	Connector 24 VDC - 3-pin female - Cage clamps 3.31 mm ²	
	Optional accessories	
	Accessories	
5AC900.150X-01	Legend Strips Template 15,0" for Automation Panel 5AP951.1505-01, 5AP980.1505-01 and 5AP981.1505-01 and Panel PC 5PC781.1505-00; for 4 devices.	

Table 25: 5AP951.1505-01 - Order data

3.1.3.2.3 Technical data

Product ID	5AP951.1505-01
General information	
B&R ID code	0x1D5F
Certification CE	Yes
Interfaces	
USB ¹⁾	
Quantity	3
Type	USB 2.0 ²⁾
Execution	Type A
Transfer rate	Low speed (1.5 Mbit/s), full speed (12 Mbit/s), high speed (480 Mbit/s)
Current load	Max. 500mA per connection
Display	
Type	Color TFT
Display size	15" (381 mm)
Colors	16.7 million
Resolution	XGA, 1024 x 768 pixels
Contrast	400:1
Viewing angles	
Horizontal	Direction R = 85° / Direction L = 85°
Vertical	Direction U = 85° / Direction D = 85°
Backlight	
Type	CCFL
Brightness	250 cd/m ²
Half-brightness time ³⁾	50,000 h
Filter glass	
Transmittance	95%
Coating	On both sides
Touch screen	
Technology	-
Controller	-
Transmittance	-
Keys	
Function keys	20 with LED (yellow)
Soft keys	12 with LED (yellow)
System keys	Alphanumeric keys, numeric keys, cursor block
Service life	> 1,000,000 actuations at 1 ±0.3 N to 3 ±0.3 N actuating force
LED brightness	
Yellow	Typ. 12 mcd
Inserts	
Compatible installation for PPC300 insert	No
Electrical characteristics	
Nominal voltage	24 VDC ±25%
Nominal current	Max. 3.2 A ⁴⁾
Starting current	Typ. 6 A, max. 30 A for < 300 µs
Power consumption	Typ. 24 W (without LED), max. 32 W or 42 W with USB (without insert)
Electrical isolation	Yes
Operating conditions	
EN 60529 protection	IP20 back side (only with Automation Panel Link card inserted) IP65 / NEMA 250 type 4X indoor, dust and sprayed water protection (front side)

Table 26: 5AP951.1505-01 - Technical data

Product ID	5AP951.1505-01
Environmental conditions	
Temperature Operation	Without Rittal housing Mounting orientation 0°: 0 to 50°C Mounting orientations to -45° display above: 0 to 50°C Mounting orientations to +45° display below: 0 to 50°C With Rittal housing Mounting orientation 0°: 0 to 40°C Mounting orientations to -45° display above: 0 to 40°C Mounting orientations to +45° display below: 0 to 40°C
Storage Transport	-25 to 60°C -25 to 60°C
Vibration Operation (continuous) Operation (occasional) Storage Transport	2 to 9 Hz: 1.75 mm amplitude / 9 to 200 Hz: 0.5 g 2 to 9 Hz: 3.5 mm amplitude / 9 to 200 Hz: 1 g 2 to 8 Hz: 7.5 mm amplitude / 8 to 200 Hz: 2 g / 200 to 500 Hz: 4 g 2 to 8 Hz: 7.5 mm amplitude / 8 to 200 Hz: 2 g / 200 to 500 Hz: 4 g
Shock Operation Storage Transport	15 g, 11 ms 30 g, 15 ms 30 g, 15 ms
Altitude Operation	Max. 3000 m ⁵⁾
Mechanical characteristics	
Housing Material Paint	Metal Similar to Pantone432CV
Front ⁶⁾ Frame Design Panel overlay Material Light background Dark gray border around display Dark gray keys Orange keys Color slide-in labels Gasket	Naturally anodized aluminum Gray Polyester Similar to Pantone 427CV Similar to Pantone432CV Similar to Pantone 431CV Similar to Pantone 151CV Similar to Pantone 429CV Flat gasket around display front
Dimensions Width Height Depth	435 mm 430 mm 54 mm
Weight	Approx. 5900 g

Table 26: 5AP951.1505-01 - Technical data

- 1) USB devices can only be connected directly to the Automation Panel (without a hub).
- 2) Depends on the transfer technology, the transfer distance and the Automation Panel Link insert card used.
- 3) At 25°C ambient temperature. Reducing the brightness by 50% can result in an approximate 50% increase of the half-brightness time.
- 4) The listed value applies to the Automation Panel device with an inserted Automation Panel Link card.
- 5) Derating the maximum ambient temperature - typically 1°C per 1000 meters (from 500 meters above sea level).
- 6) Depending on the process or batch, there may be visible deviations in the color and surface structure.

3.1.3.2.4 Temperature humidity diagram

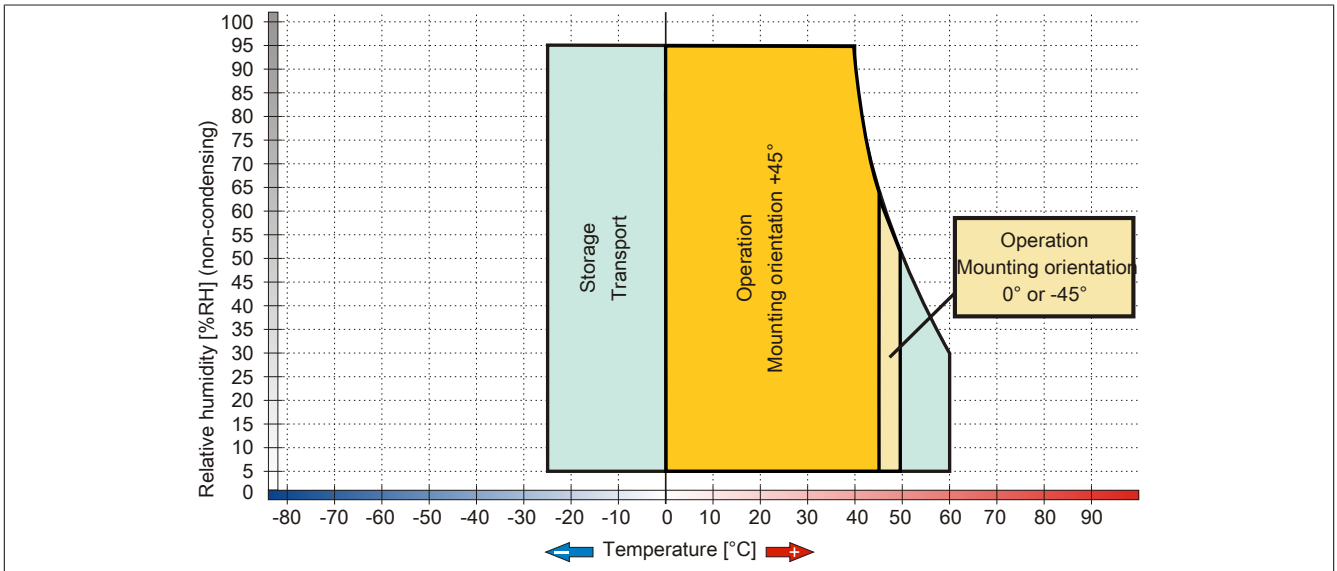

Figure 52: 5AP951.1505-01 - Temperature humidity diagram

3.1.3.2.5 Dimensions

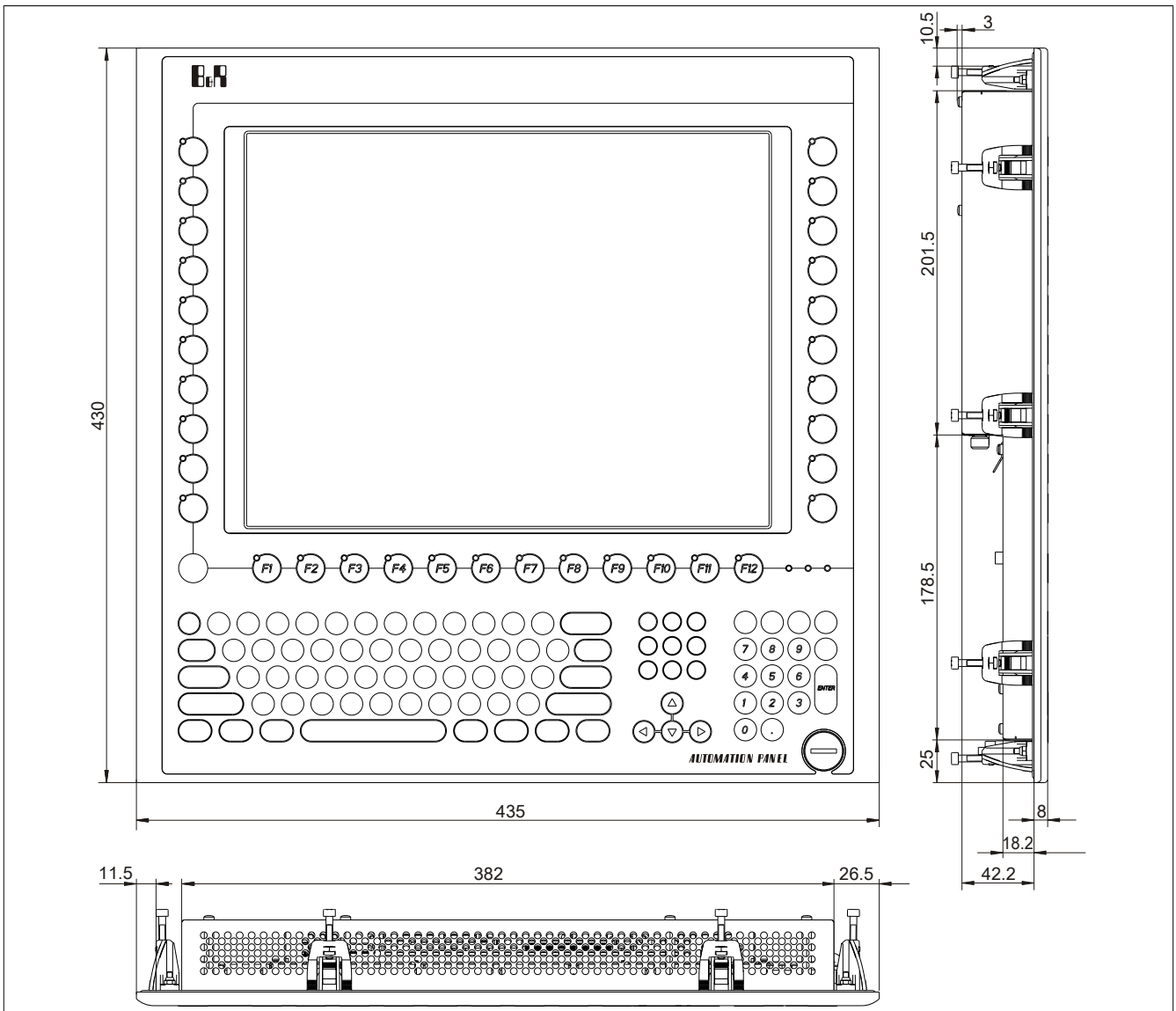

Figure 53: 5AP951.1505-01 - Dimensions

3.1.3.2.6 Cutout installation

The Automation Panel can be installed in a wall cutout using the pre-installed clamping blocks. To do so, it is necessary to make a cutout that corresponds to the following diagram.

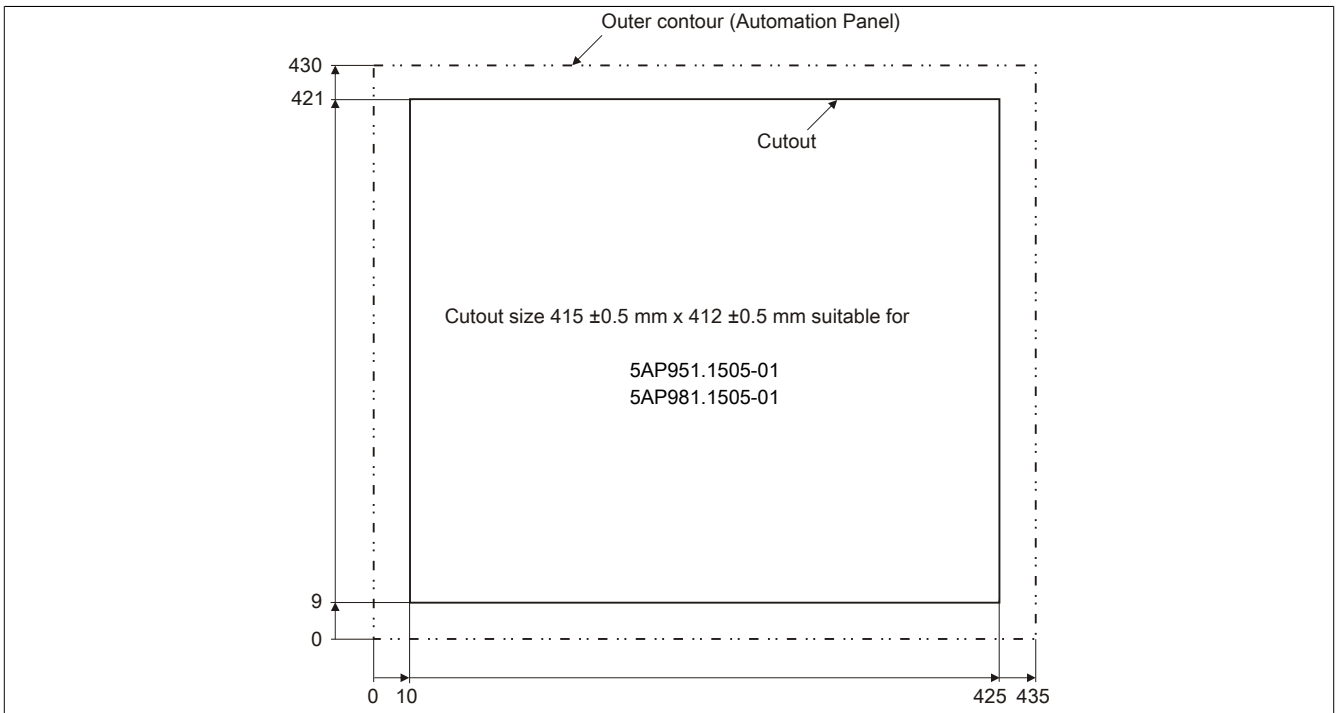

Figure 54: 5AP951.1505-01 - Cutout installation

For additional information regarding installation and mounting orientation, see "Installation" on page 109.

3.1.3.3 5AP980.1505-01

3.1.3.3.1 General information

- 15" XGA color TFT display
- Analog resistive touch screen
- Function keys and soft keys
- Small installation depth
- Fan-free operation
- Can be upgraded with Display Link cards or PPC300

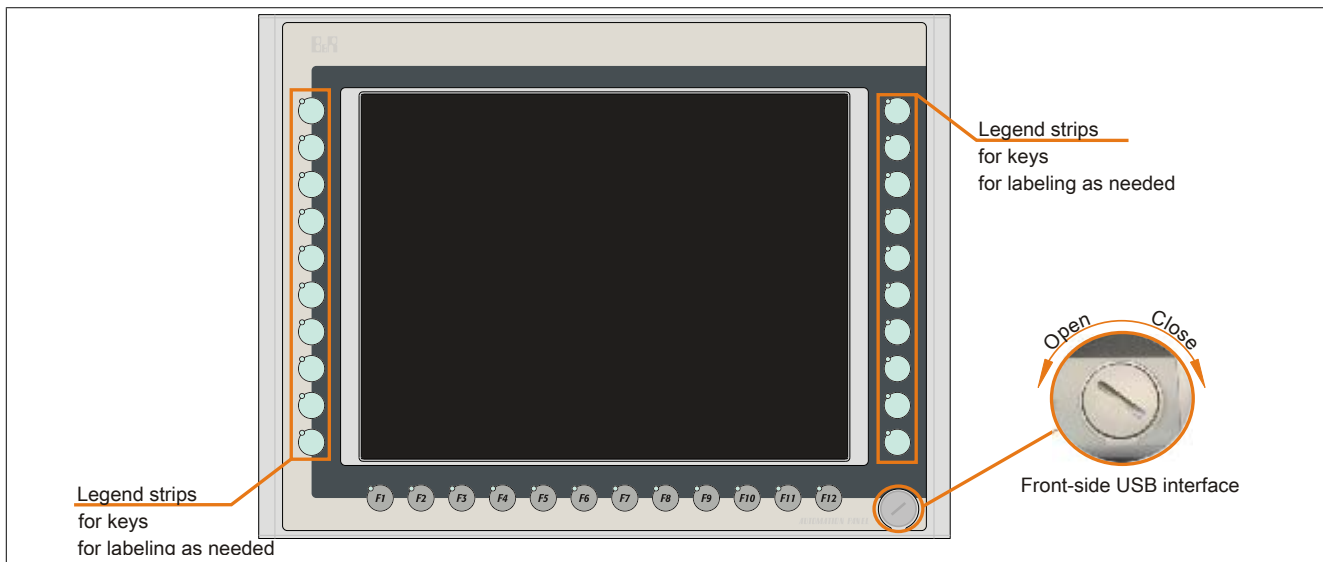

Figure 55: 5AP920.1505-01 - Front view

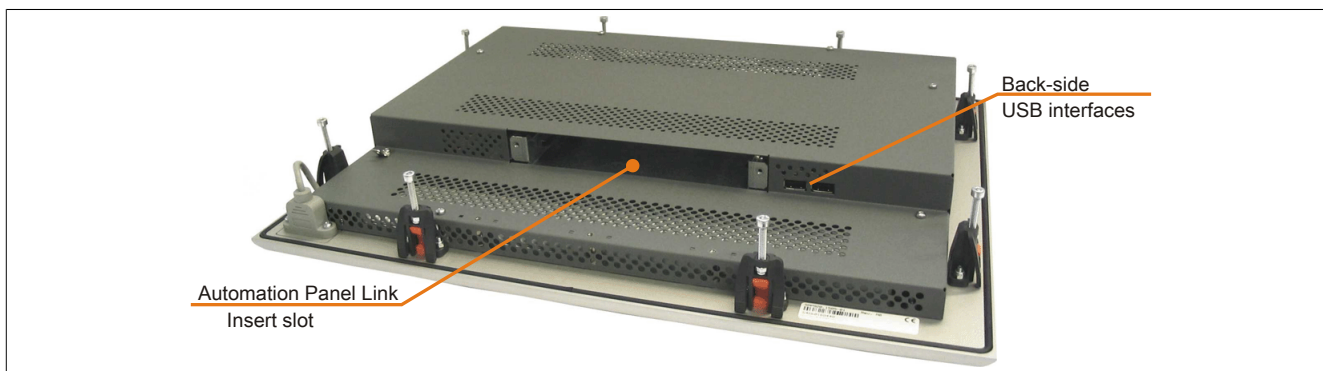

Figure 56: 5AP980.1505-01 - Rear view

3.1.3.3.2 Order data

Model number	Short description	Figure
	Display units	
5AP980.1505-01	Automation Panel AP980, 15" XGA color TFT display with touch screen (resistive); 12 soft keys and 20 function keys; 3 USB 2.0 interfaces; insert for Automation Panel Link; IP65 protection (front). 24 VDC.	
	Required accessories	
	Display links	
5DL DVI.1000-01	Automation Panel Link DVI receiver; connections for DVI-D, RS232 and USB 2.0 (Type B); 24 VDC (order screw clamp 0TB103.9 or cage clamp 0TB103.91 separately).	
5DLS D3.1000-00	Automation Panel Link SDL3 receiver - For Automation Panel 920/98x	
5DLS DL.1000-00	Automation Panel Link SDL receiver; connection for SDL In; transmission of display, touch screen, USB 1.1, matrix key and service data; 24 VDC (order screw clamp 0TB103.9 or cage clamp 0TB103.91 separately).	

Table 27: 5AP980.1505-01 - Order data

Model number	Short description	Figure
5DLSDL.1000-01	Automation Panel Link SDL transceiver; connections for SDL In and SDL Out; transmission of display, touch screen, USB 1.1, matrix key and service data; 24 VDC (order screw clamp 0TB103.9 or cage clamp 0TB103.91 separately).	
	Terminal blocks	
0TB103.9	Connector 24 VDC - 3-pin female - Screw clamps 3.31 mm ²	
0TB103.91	Connector 24 VDC - 3-pin female - Cage clamps 3.31 mm ²	
	Optional accessories	
	Accessories	
5AC900.150X-01	Legend Strips Template 15,0" for Automation Panel 5AP951.1505-01, 5AP980.1505-01 and 5AP981.1505-01 and Panel PC 5PC781.1505-00; for 4 devices.	
	Panel PC 300 insert cards	
5PC310.L800-00	Panel PC 300 insert card for the Automation Panel 900; 256 MB SDRAM; CompactFlash slot (Type I); 2x ETH 10/100; RS232; USB 2.0 (via integrated USB 2.0 interfaces on the Automation Panel); battery; 24 VDC (order screw clamp 0TB103.9 or cage clamp 0TB103.91 separately)	
5PC310.L800-01	Panel PC 300 insert card for the Automation Panel 900; 512 MB SDRAM; CompactFlash slot (Type I); 2x ETH 10/100; RS232; USB 2.0 (via integrated USB 2.0 interfaces on the Automation Panel); battery; 24 VDC (order screw clamp 0TB103.9 or cage clamp 0TB103.91 separately)	

Table 27: 5AP980.1505-01 - Order data

3.1.3.3.3 Technical data

Product ID	5AP980.1505-01		
Revision	H0	I0	J0
General information			
B&R ID code	0x1D5E		
Certification			
CE	Yes		
cULus	Yes		
GOST-R	Yes		
Interfaces			
USB ¹⁾			
Quantity	3		
Type	USB 2.0 ²⁾		
Execution	Type A		
Transfer rate	Low speed (1.5 Mbit/s), full speed (12 Mbit/s), high speed (480 Mbit/s)		
Current load	Max. 500 mA per connection		
Display			
Type	TFT color		
Display size	15" (381 mm)		
Colors	16.7 million		
Resolution	XGA, 1024 x 768 pixels		
Contrast	400:1	1000:1	
Viewing angles			
Horizontal	Direction R = 85° / Direction L = 85°		
Vertical	Direction U = 85° / Direction D = 85°		
Backlight			
Type	CCFL	LED	
Brightness	250 cd/m ²	350 cd/m ²	
Half-brightness time ³⁾	50,000 h	70,000 h	
Filter glass			
Transmittance	-		
Coating	-		
Touch screen ⁴⁾			
Type	Elo AccuTouch	AMT	
Technology	Analog, resistive		
Controller	Elo, serial, 12-bit		
Transmittance	80% ±5%	81% ±3%	
Keys			
Function keys	20 with LED (yellow)		
Soft keys	12 with LED (yellow)		
System keys	No		
Service life	>1,000,000 actuations at 1 ±0.3N to 3 ±0.3 N actuating force		
LED brightness			
Yellow	Typ. 12 mcd		
Inserts			
Compatible installation for PPC300 insert	Yes		
Electrical characteristics			
Nominal voltage	24 VDC ±25%		

Table 28: 5AP980.1505-01, 5AP980.1505-01, 5AP980.1505-01 - Technical data

Product ID	5AP980.1505-01
Nominal current	Max. 3.2 A ⁵⁾
Starting current	Typ. 6 A, max. 30 A for <300 µs
Power consumption	Typ. 24 W (without LED), max. 32 W or 42 W with USB (without insert)
Electrical isolation	Yes
Operating conditions	
EN 60529 protection	Back: IP20 (only with an inserted Automation Panel Link card) Front: IP65 / NEMA 250 type 4X indoor, dust and sprayed water protection
Environmental conditions	
Temperature Operation	Without Rittal housing Mounting orientation 0°: 0 to 50°C Mounting orientations to -45° display above: 0 to 50°C Mounting orientations to +45° display below: 0 to 45°C
Storage Transport	With Rittal housing Mounting orientation 0°: 0 to 40°C Mounting orientations to -45° display above: 0 to 40°C Mounting orientations to +45° display below: 0 to 40°C -25 to 60°C -25 to 60°C
Vibration Operation (continuous) Operation (occasional) Storage Transport	2 to 9 Hz: 1.75 mm amplitude / 9 to 200 Hz: 0.5 g 2 to 9 Hz: 3.5 mm amplitude / 9 to 200 Hz: 1 g 2 to 8 Hz: 7.5 mm amplitude / 8 to 200 Hz: 2 g / 200 to 500 Hz: 4 g 2 to 8 Hz: 7.5 mm amplitude / 8 to 200 Hz: 2 g / 200 to 500 Hz: 4 g
Shock Operation Storage Transport	15 g, 11 ms 30 g, 15 ms 30 g, 15 ms
Altitude Operation	Max. 3000 m ⁶⁾
Mechanical characteristics	
Housing Material Paint	Metal Similar to Pantone 432CV
Front ⁷⁾ Frame Design Panel overlay Material Light background Dark gray border around display Color slide-in labels Gasket	Naturally anodized aluminum Gray Polyester Similar to Pantone 427CV Similar to Pantone 432CV Similar to Pantone 429CV Flat gasket around display front
Dimensions Width Height Depth	435 mm 330 mm 54 mm
Weight	Approx. 5100 g

Table 28: 5AP980.1505-01, 5AP980.1505-01, 5AP980.1505-01 - Technical data

- 1) USB devices can only be connected to the Automation Panel directly (i.e. without a hub).
- 2) Depends on the transmission technology, the transfer distance and the Automation Panel Link insert card being used.
- 3) At an ambient temperature of 25°C. Reducing the brightness by 50% can result in an approximately 50% increase in the half-brightness time.
- 4) Touch screen drivers for approved operating systems are available in the Downloads section of the B&R website.
- 5) The specified value applies to Automation Panel systems with an inserted Automation Panel Link card.
- 6) The maximum ambient temperature is typically derated by 1°C per 1000 meters (starting at 500 meters above sea level).
- 7) There may be visible deviations in the color and surface appearance depending on the process or batch.

3.1.3.3.4 Temperature humidity diagram

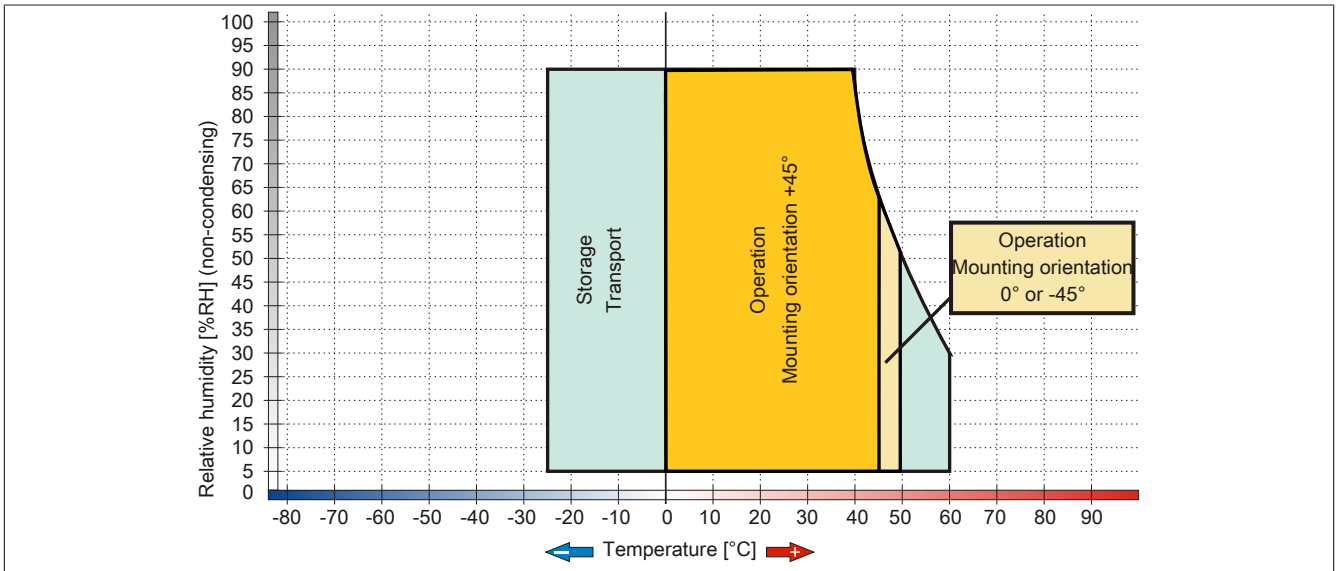

Figure 57: 5AP980.1505-01 - Temperature humidity diagram

3.1.3.3.5 Dimensions

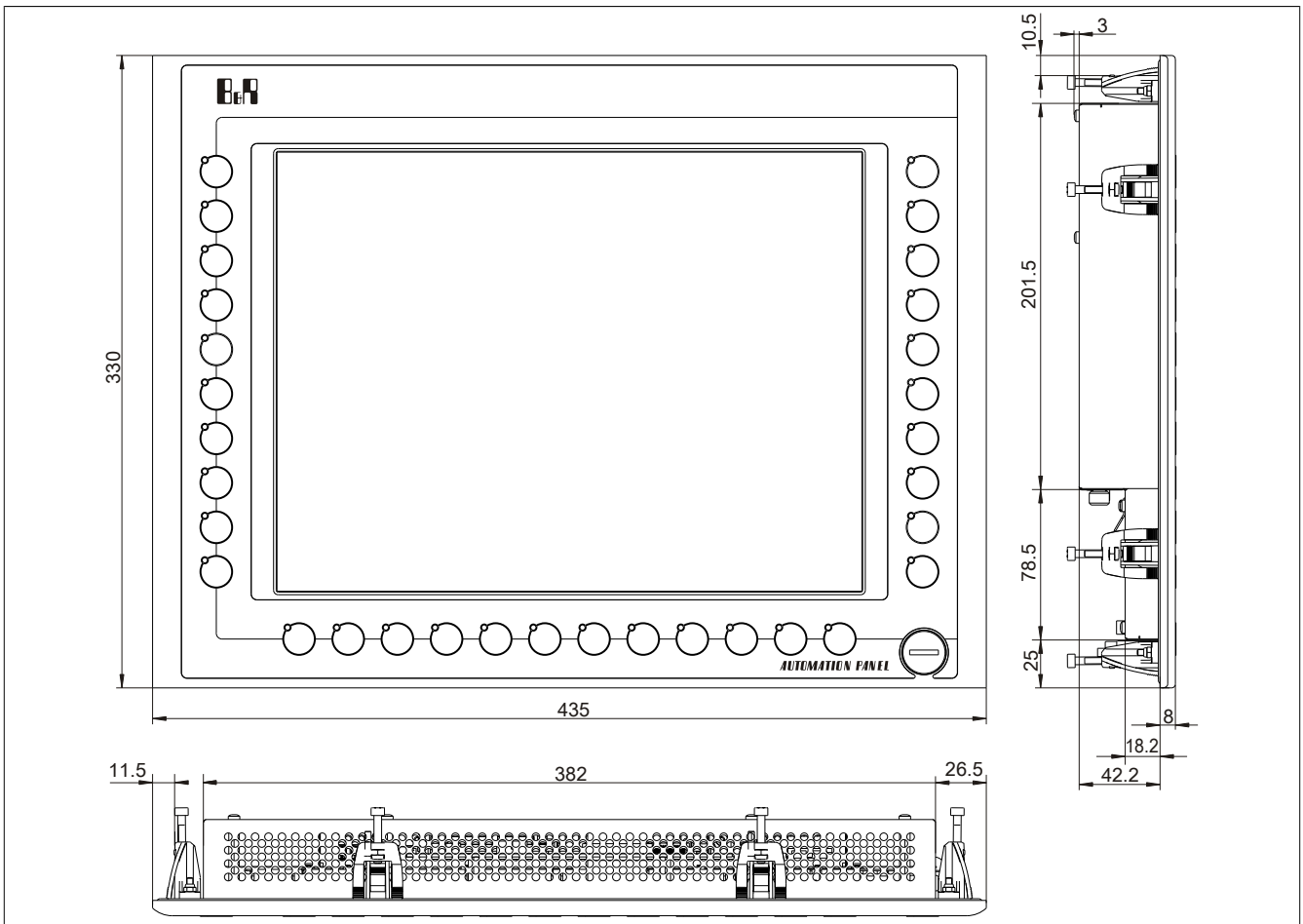

Figure 58: 5AP980.1505-01 - Dimensions

3.1.3.3.6 Cutout installation

The Automation Panel can be installed in a wall cutout using the pre-installed clamping blocks. To do so, it is necessary to make a cutout that corresponds to the following diagram.

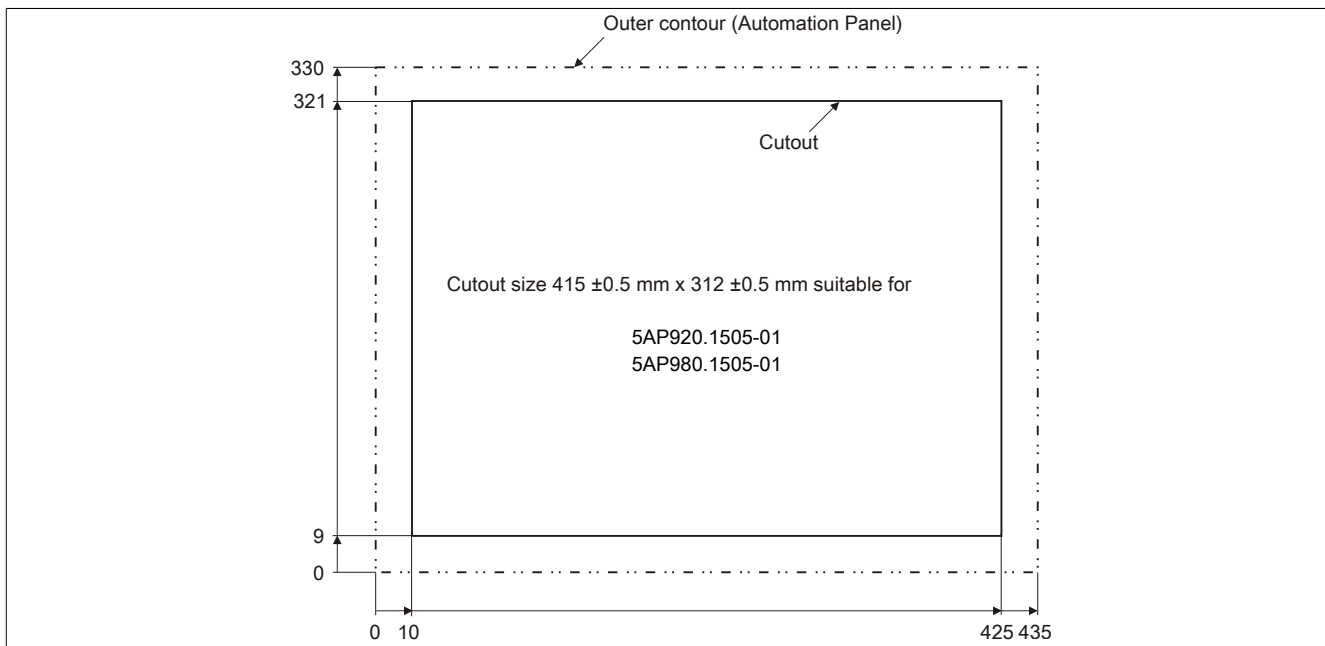

Figure 59: 5AP980.1505-01 - Cutout installation

For additional information regarding installation and mounting orientation, see "Installation" on page 109.

3.1.3.4 5AP981.1505-01

3.1.3.4.1 General information

- 15" XGA color TFT display
- Analog resistive touch screen
- Function keys, system keys and soft keys
- Small installation depth
- Fan-free operation
- Can be upgraded with Display Link cards or PPC300

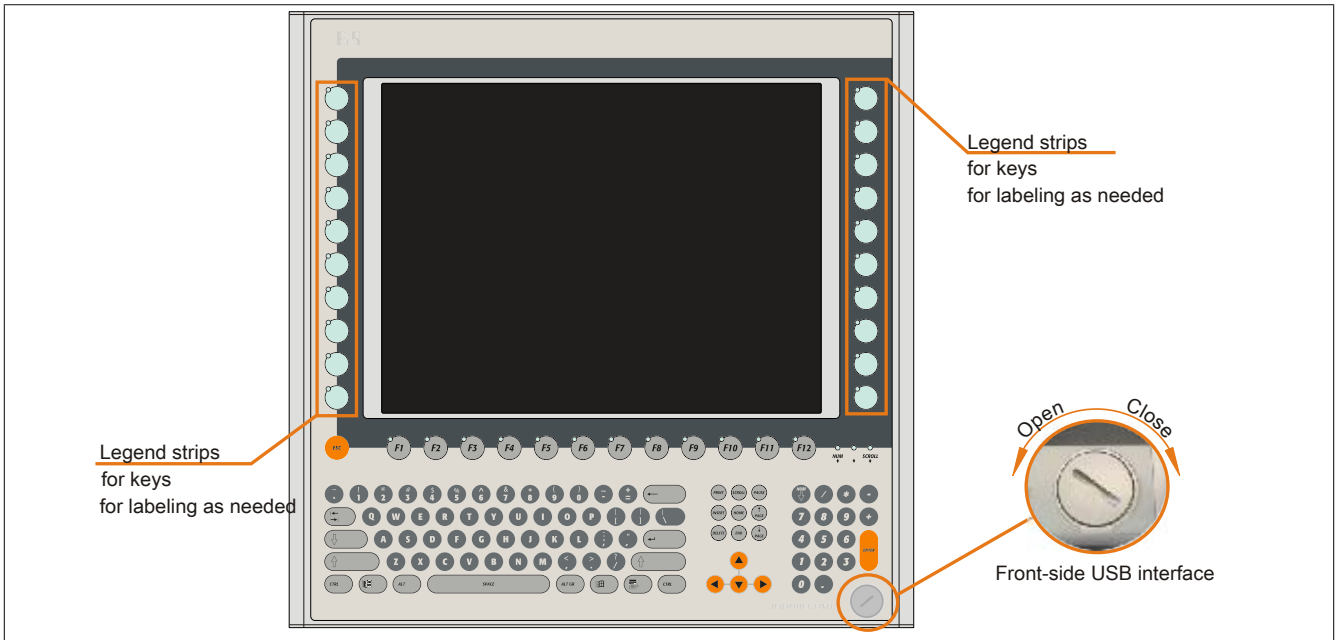

Figure 60: 5AP981.1505-01 - Front view

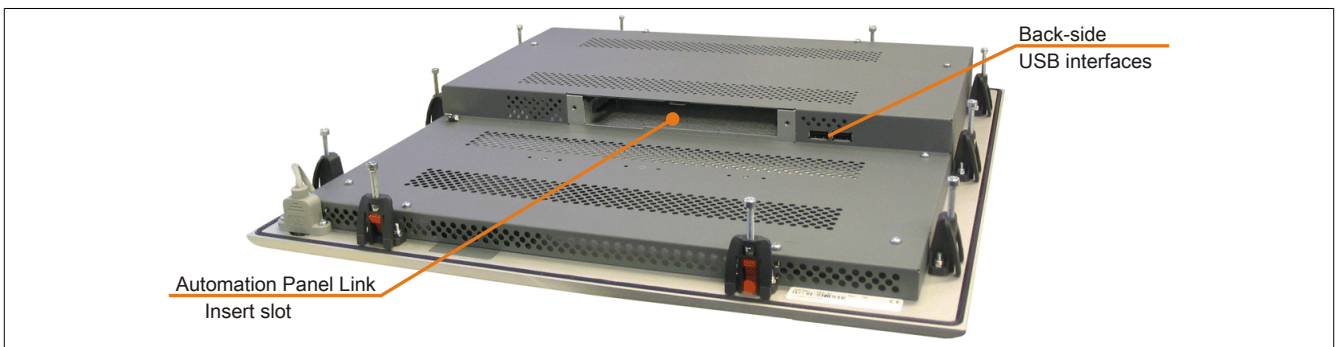

Figure 61: 5AP981.1505-01 - Rear view

3.1.3.4.2 Order data

Model number	Short description	Figure
	Display units	
5AP981.1505-01	Automation Panel AP981; 15" XGA color TFT display with touch screen (resistive); 12 soft keys; 20 function keys and 92 system keys; 3 USB 2.0 interfaces; insert for Automation Panel Link; IP65 protection (front). 24 VDC.	
	Required accessories	
	Display links	
5DLDMI.1000-01	Automation Panel Link DVI receiver; connections for DVI-D, RS232 and USB 2.0 (Type B); 24 VDC (order screw clamp 0TB103.9 or cage clamp 0TB103.91 separately).	
5DLS3.1000-00	Automation Panel Link SDL3 receiver - For Automation Panel 920/98x	
5DLSL.1000-00	Automation Panel Link SDL receiver; connection for SDL In; transmission of display, touch screen, USB 1.1, matrix key and service data; 24 VDC (order screw clamp 0TB103.9 or cage clamp 0TB103.91 separately).	
5DLSL.1000-01	Automation Panel Link SDL transceiver; connections for SDL In and SDL Out; transmission of display, touch screen, USB 1.1, matrix key and service data; 24 VDC (order screw clamp 0TB103.9 or cage clamp 0TB103.91 separately).	
	Terminal blocks	
0TB103.9	Connector 24 VDC - 3-pin female - Screw clamps 3.31 mm ²	
0TB103.91	Connector 24 VDC - 3-pin female - Cage clamps 3.31 mm ²	
	Optional accessories	
	Accessories	
5AC900.150X-01	Legend Strips Template 15,0" for Automation Panel 5AP951.1505-01, 5AP980.1505-01 and 5AP981.1505-01 and Panel PC 5PC781.1505-00; for 4 devices.	
	Panel PC 300 insert cards	
5PC310.L800-00	Panel PC 300 insert card for the Automation Panel 900; 256 MB SDRAM; CompactFlash slot (Type I); 2x ETH 10/100; RS232; USB 2.0 (via integrated USB 2.0 interfaces on the Automation Panel); battery; 24 VDC (order screw clamp 0TB103.9 or cage clamp 0TB103.91 separately)	
5PC310.L800-01	Panel PC 300 insert card for the Automation Panel 900; 512 MB SDRAM; CompactFlash slot (Type I); 2x ETH 10/100; RS232; USB 2.0 (via integrated USB 2.0 interfaces on the Automation Panel); battery; 24 VDC (order screw clamp 0TB103.9 or cage clamp 0TB103.91 separately)	

Table 29: 5AP981.1505-01 - Order data

3.1.3.4.3 Technical data

Product ID	5AP981.1505-01		
Revision	J0	K0	M0
General information			
B&R ID code	0x1C64		
Certification			
CE	Yes		
cULus	Yes		
GOST-R	Yes		
Interfaces			
USB ¹⁾			
Quantity	3		
Type	USB 2.0 ²⁾		
Execution	Type A		
Transfer rate	Low speed (1.5 Mbit/s), full speed (12 Mbit/s), high speed (480 Mbit/s)		
Current load	Max. 500 mA per connection		
Display			
Type	TFT color		
Display size	15" (381 mm)		
Colors	16.7 million		
Resolution	XGA, 1024 x 768 pixels		
Contrast	400:1		1000:1
Viewing angles			
Horizontal	Direction R = 85° / Direction L = 85°		
Vertical	Direction U = 85° / Direction D = 85°		
Backlight			
Type	CCFL		LED
Brightness	250 cd/m ²		350 cd/m ²
Half-brightness time ³⁾	50,000 h		70,000 h
Filter glass			
Transmittance	-		
Coating	-		

Table 30: 5AP981.1505-01, 5AP981.1505-01, 5AP981.1505-01 - Technical data

Product ID		5AP981.1505-01	
Touch screen ⁴⁾			
Type	Elo AccuTouch		AMT
Technology		Analog, resistive	
Controller		Elo, serial, 12-bit	
Transmittance	80% ±5%		81% ±3%
Keys			
Function keys	20 with LED (yellow)		
Soft keys	12 with LED (yellow)		
System keys	Alphanumeric keys, numeric keys, cursor block		
Service life	>1,000,000 actuations at 1 ±0.3N to 3 ±0.3 N actuating force		
LED brightness			
Yellow	Typ. 12 mcd		
Inserts			
Compatible installation for PPC300 insert	Yes		
Electrical characteristics			
Nominal voltage	24 VDC ±25%		
Nominal current	Max. 3.2 A ⁵⁾		
Starting current	Typ. 6 A, max. 30 A for <300 µs		
Power consumption	Typ. 24 W (without LED), max. 32 W or 42 W with USB (without insert)		
Electrical isolation	Yes		
Operating conditions			
EN 60529 protection	Back: IP20 (only with an inserted Automation Panel Link card) Front: IP65 / NEMA 250 type 4X indoor, dust and sprayed water protection		
Environmental conditions			
Temperature			
Operation	Without Rittal housing Mounting orientation 0°: 0 to 50°C Mounting orientations to -45° display above: 0 to 50°C Mounting orientations to +45° display below: 0 to 45°C		
	With Rittal housing Mounting orientation 0°: 0 to 40°C Mounting orientations to -45° display above: 0 to 40°C Mounting orientations to +45° display below: 0 to 40°C		
Storage	-25 to 60°C		
Transport	-25 to 60°C		
Vibration			
Operation (continuous)	2 to 9 Hz: 1.75 mm amplitude / 9 to 200 Hz: 0.5 g		
Operation (occasional)	2 to 9 Hz: 3.5 mm amplitude / 9 to 200 Hz: 1 g		
Storage	2 to 8 Hz: 7.5 mm amplitude / 8 to 200 Hz: 2 g / 200 to 500 Hz: 4 g		
Transport	2 to 8 Hz: 7.5 mm amplitude / 8 to 200 Hz: 2 g / 200 to 500 Hz: 4 g		
Shock			
Operation	15 g, 11 ms		
Storage	30 g, 15 ms		
Transport	30 g, 15 ms		
Altitude			
Operation	Max. 3000 m ⁶⁾		
Mechanical characteristics			
Housing			
Material	Metal		
Paint	Similar to Pantone 432CV		
Front ⁷⁾			
Frame	Naturally anodized aluminum		
Design	Gray		
Panel overlay			
Material	Polyester		
Light background	Similar to Pantone 427CV		
Dark gray border around display	Similar to Pantone 432CV		
Dark gray keys	Similar to Pantone 431CV		
Orange keys	Similar to Pantone 151CV		
Color slide-in labels	Similar to Pantone 429CV		
Gasket	Flat gasket around display front		
Dimensions			
Width	435 mm		
Height	430 mm		
Depth	54 mm		
Weight	Approx. 5900 g		

Table 30: 5AP981.1505-01, 5AP981.1505-01, 5AP981.1505-01 - Technical data

- 1) USB devices can only be connected to the Automation Panel directly (i.e. without a hub).
- 2) Depends on the transmission technology, the transfer distance and the Automation Panel Link insert card being used.
- 3) At an ambient temperature of 25°C. Reducing the brightness by 50% can result in an approximately 50% increase in the half-brightness time.
- 4) Touch screen drivers for approved operating systems are available in the Downloads section of the B&R website.
- 5) The specified value applies to Automation Panel systems with an inserted Automation Panel Link card.
- 6) The maximum ambient temperature is typically derated by 1°C per 1000 meters (starting at 500 meters above sea level).
- 7) There may be visible deviations in the color and surface appearance depending on the process or batch.

3.1.3.4.4 Temperature humidity diagram

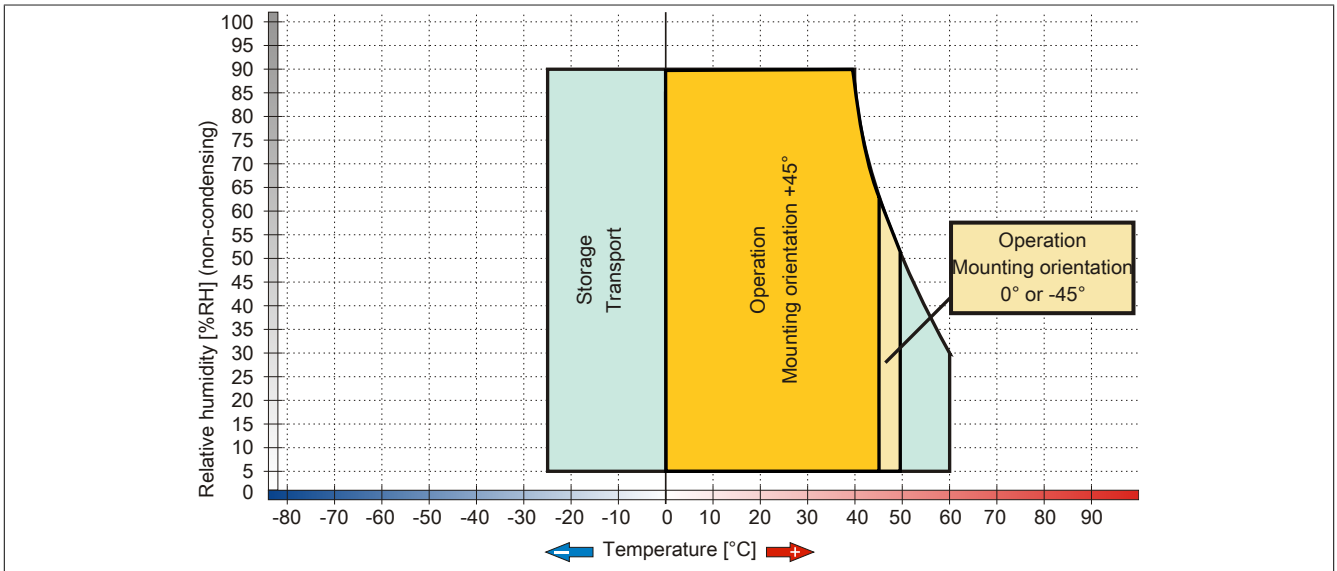

Figure 62: 5AP981.1505-01 - Temperature humidity diagram

3.1.3.4.5 Dimensions

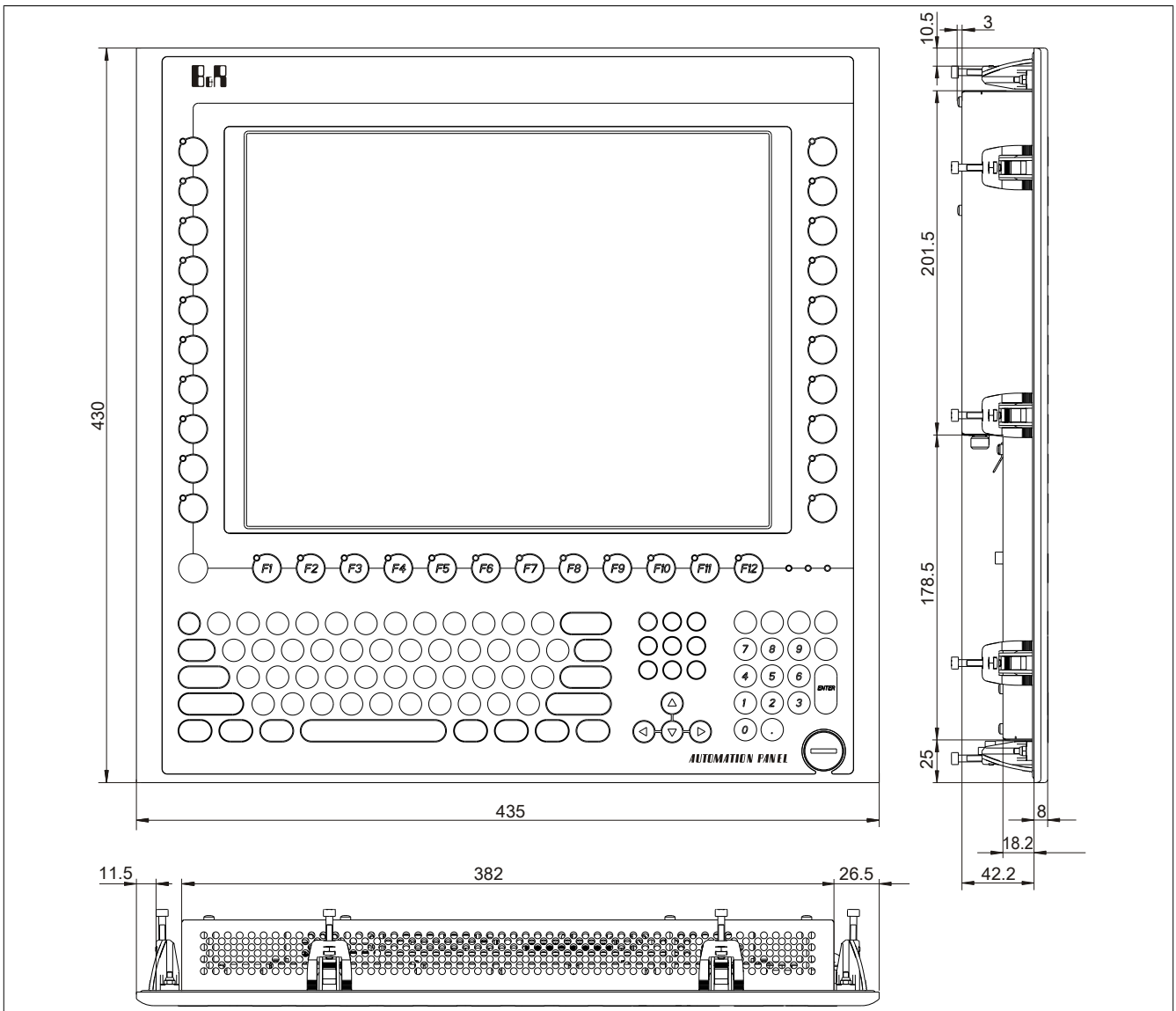

Figure 63: 5AP981.1505-01 - Dimensions

3.1.3.4.6 Cutout installation

The Automation Panel can be installed in a wall cutout using the pre-installed clamping blocks. To do so, it is necessary to make a cutout that corresponds to the following diagram.

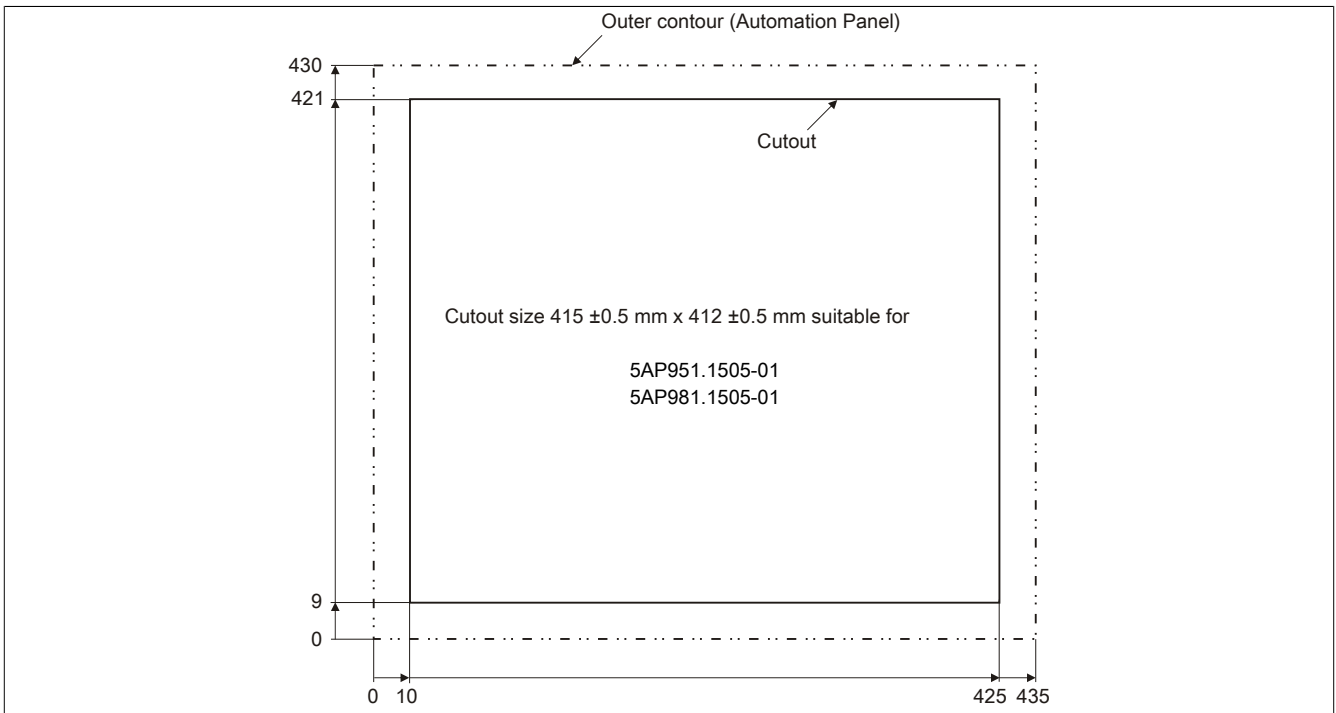

Figure 64: 5AP981.1505-01 - Cutout installation

For additional information regarding installation and mounting orientation, see "Installation" on page 109.

3.1.4 Automation Panel 17" SXGA

3.1.4.1 5AP920.1706-01

3.1.4.1.1 General information

- 17" TFT SXGA color display
- Analog resistive touch screen
- Small installation depth
- Fan-free operation
- Can be upgraded with Display Link cards or PPC300

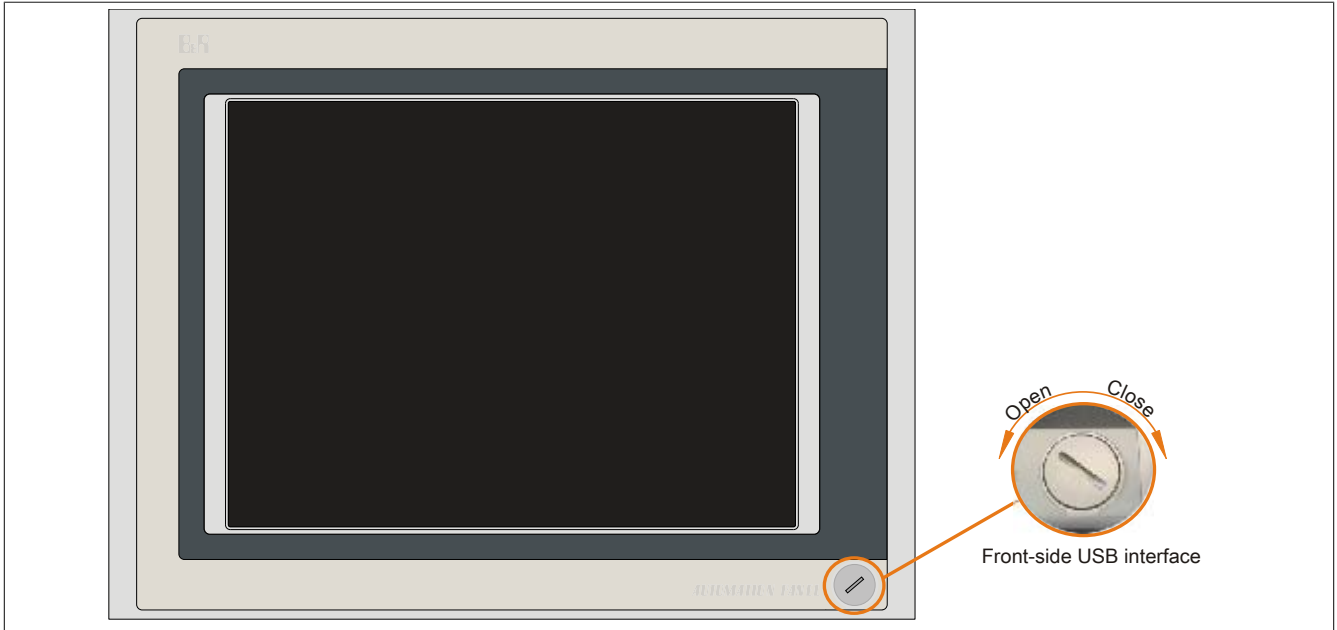

Figure 65: 5AP920.1706-01 - Front view

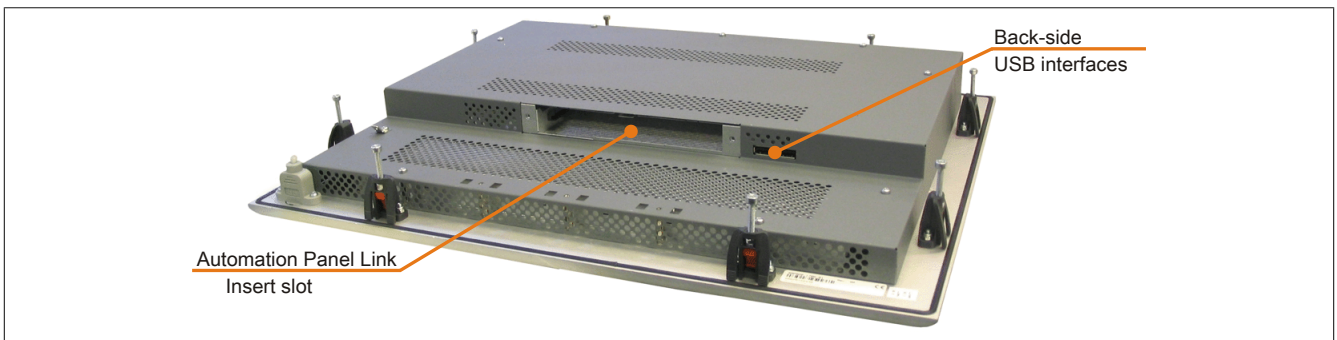

Figure 66: 5AP920.1706-01 - Rear view

3.1.4.1.2 Order data

Model number	Short description	Figure
Display units		
5AP920.1706-01	Automation Panel AP920 17" SXGA color TFT display with touch screen (resistive); 3 USB 2.0 interfaces; slot for Automation Panel link; IP65 protection (from front). 24 VDC.	
Required accessories		
Display links		
5DLDVI.1000-01	Automation Panel Link DVI receiver; connections for DVI-D, RS232 and USB 2.0 (Type B); 24 VDC (order screw clamp 0TB103.9 or cage clamp 0TB103.91 separately).	
5DLSDL.1000-00	Automation Panel Link SDL receiver; connection for SDL In; transmission of display, touch screen, USB 1.1, matrix key and service data; 24 VDC (order screw clamp 0TB103.9 or cage clamp 0TB103.91 separately).	
5DLSDL.1000-01	Automation Panel Link SDL transceiver; connections for SDL In and SDL Out; transmission of display, touch screen, USB 1.1, matrix key and service data; 24 VDC (order screw clamp 0TB103.9 or cage clamp 0TB103.91 separately).	
Terminal blocks		
0TB103.9	Connector 24 VDC - 3-pin female - Screw clamps 3.31 mm ²	
0TB103.91	Connector 24 VDC - 3-pin female - Cage clamps 3.31 mm ²	
Optional accessories		
Panel PC 300 insert cards		
5PC310.L800-00	Panel PC 300 insert card for the Automation Panel 900; 256 MB SDRAM; CompactFlash slot (Type I); 2x ETH 10/100; RS232; USB 2.0 (via integrated USB 2.0 interfaces on the Automation Panel); battery; 24 VDC (order screw clamp 0TB103.9 or cage clamp 0TB103.91 separately)	
5PC310.L800-01	Panel PC 300 insert card for the Automation Panel 900; 512 MB SDRAM; CompactFlash slot (Type I); 2x ETH 10/100; RS232; USB 2.0 (via integrated USB 2.0 interfaces on the Automation Panel); battery; 24 VDC (order screw clamp 0TB103.9 or cage clamp 0TB103.91 separately)	

Table 31: 5AP920.1706-01 - Order data

3.1.4.1.3 Technical data

Product ID	5AP920.1706-01	
Revision	C0	D0
General information		
B&R ID code	0x1A06	
Certification		
CE	Yes	
cULus	Yes	
GOST-R	Yes	
Interfaces		
USB ¹⁾		
Quantity	3	
Type	USB 2.0 ²⁾	
Execution	Type A	
Transfer rate	Low speed (1.5 Mbit/s), full speed (12 Mbit/s), high speed (480 Mbit/s)	
Current load	Max. 500mA per connection	
Display		
Type	Color TFT	
Display size	17" (431 mm)	
Colors	16.7 million	
Resolution	SXGA, 1280 x 1024 pixels	
Contrast	600:1	
Viewing angles		
Horizontal	Direction R = 75° / Direction L = 75°	
Vertical	Direction U = 75° / direction D = 60°	
Backlight		
Type	CCFL	
Brightness	250 cd/m ²	
Half-brightness time ³⁾	30,000 h	50,000 h
Filter glass		
Transmittance	-	
Coating	-	
Touch screen ⁴⁾		
Type	Elo AccuTouch	
Technology	Analog, resistive	
Controller	Elo, serial, 12-bit	
Transmittance	80% ±5%	

Table 32: 5AP920.1706-01, 5AP920.1706-01 - Technical data

Product ID	5AP920.1706-01	
Keys		
Function keys	No	
Soft keys	No	
System keys	No	
Service life	-	
LED brightness	-	
Yellow	-	
Inserts		
Compatible installation for PPC300 insert	Yes	
Electrical characteristics		
Nominal voltage	24 VDC ±25%	
Nominal current	Max. 3.2 A ⁵⁾	
Starting current	Typ. 6 A, max. 30 A for < 300 µs	
Power consumption	Typ. 27 W, max. 36 W or 46 W with USB (without insert)	
Electrical isolation	Yes	
Operating conditions		
EN 60529 protection	IP20 back side (only with Automation Panel Link card inserted) IP65 / NEMA 250 type 4X indoor, dust and sprayed water protection (front side)	
Environmental conditions		
Temperature	Without Rittal housing	
Operation	Mounting orientation 0°: 0 to 40°C Mounting orientations to -45° display above: 0 to 45°C Mounting orientations to +45° display below: 0 to 35°C	
Storage	-20 to 60°C	-25 to 60°C
Transport	-20 to 60°C	-25 to 60°C
Vibration	2 to 9 Hz: 1.75 mm amplitude / 9 to 200 Hz: 0.5 g	
Operation (continuous)	2 to 9 Hz: 3.5 mm amplitude / 9 to 200 Hz: 1 g	
Operation (occasional)	2 to 8 Hz: 7.5 mm amplitude / 8 to 200 Hz: 2 g / 200 to 500 Hz: 4 g	
Storage	2 to 8 Hz: 7.5 mm amplitude / 8 to 200 Hz: 2 g / 200 to 500 Hz: 4 g	
Transport	2 to 8 Hz: 7.5 mm amplitude / 8 to 200 Hz: 2 g / 200 to 500 Hz: 4 g	
Shock	15 g, 11 ms	
Operation	30 g, 15 ms	
Storage	30 g, 15 ms	
Transport	30 g, 15 ms	
Altitude	Max. 3000 m ⁶⁾	
Operation	Max. 3000 m ⁶⁾	
Mechanical characteristics		
Housing	Metal	
Material	Similar to Pantone432CV	
Paint	Similar to Pantone432CV	
Front ⁷⁾	Naturally anodized aluminum	
Frame	Gray	
Design	Polyester	
Panel overlay	Similar to Pantone 427CV	
Material	Similar to Pantone432CV	
Light background	Flat gasket around display front	
Dark gray border around display	Flat gasket around display front	
Gasket	Flat gasket around display front	
Dimensions	477 mm	
Width	390 mm	
Height	59 mm	
Depth	Approx. 7000 g	
Weight	Approx. 7000 g	

Table 32: 5AP920.1706-01, 5AP920.1706-01 - Technical data

- 1) USB devices can only be connected directly to the Automation Panel (without a hub).
- 2) Depends on the transfer technology, the transfer distance and the Automation Panel Link insert card used.
- 3) At 25°C ambient temperature. Reducing the brightness by 50% can result in an approximate 50% increase of the half-brightness time.
- 4) Touch screen drivers can be downloaded from the download area on the B&R homepage (www.br-automation.com).
- 5) The listed value applies to the Automation Panel device with an inserted Automation Panel Link card.
- 6) Derating the maximum ambient temperature - typically 1°C per 1000 meters (from 500 meters above sea level).
- 7) Depending on the process or batch, there may be visible deviations in the color and surface structure.

3.1.4.1.4 Temperature humidity diagram

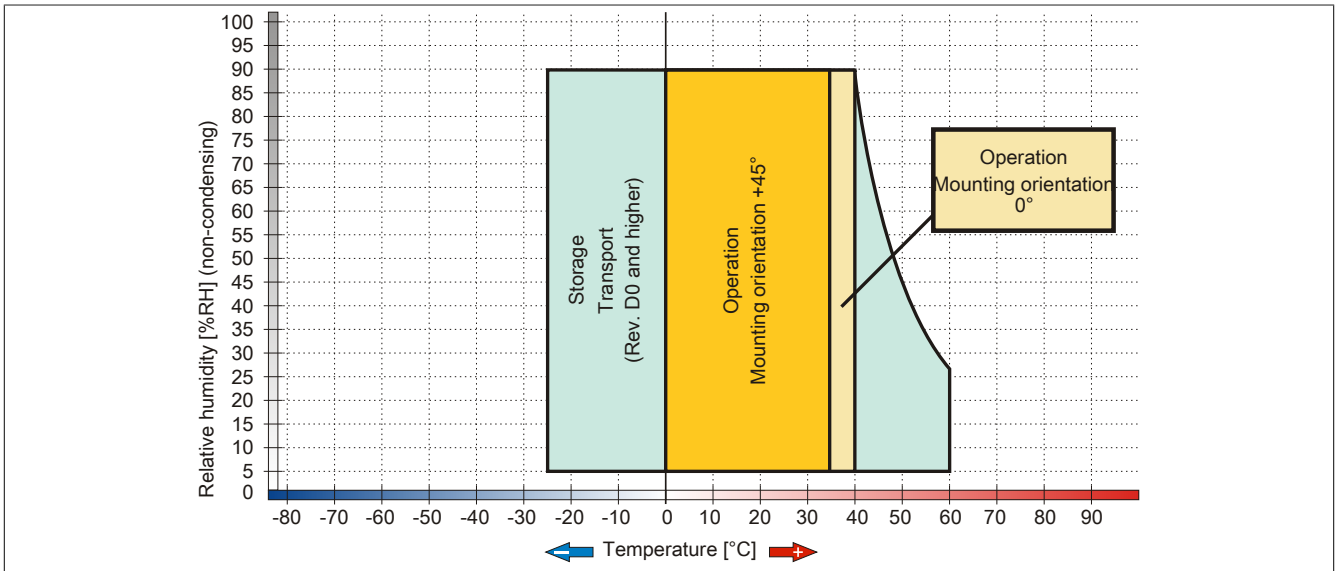

Figure 67: 5AP920.1706-01 - Temperature humidity diagram

3.1.4.1.5 Dimensions

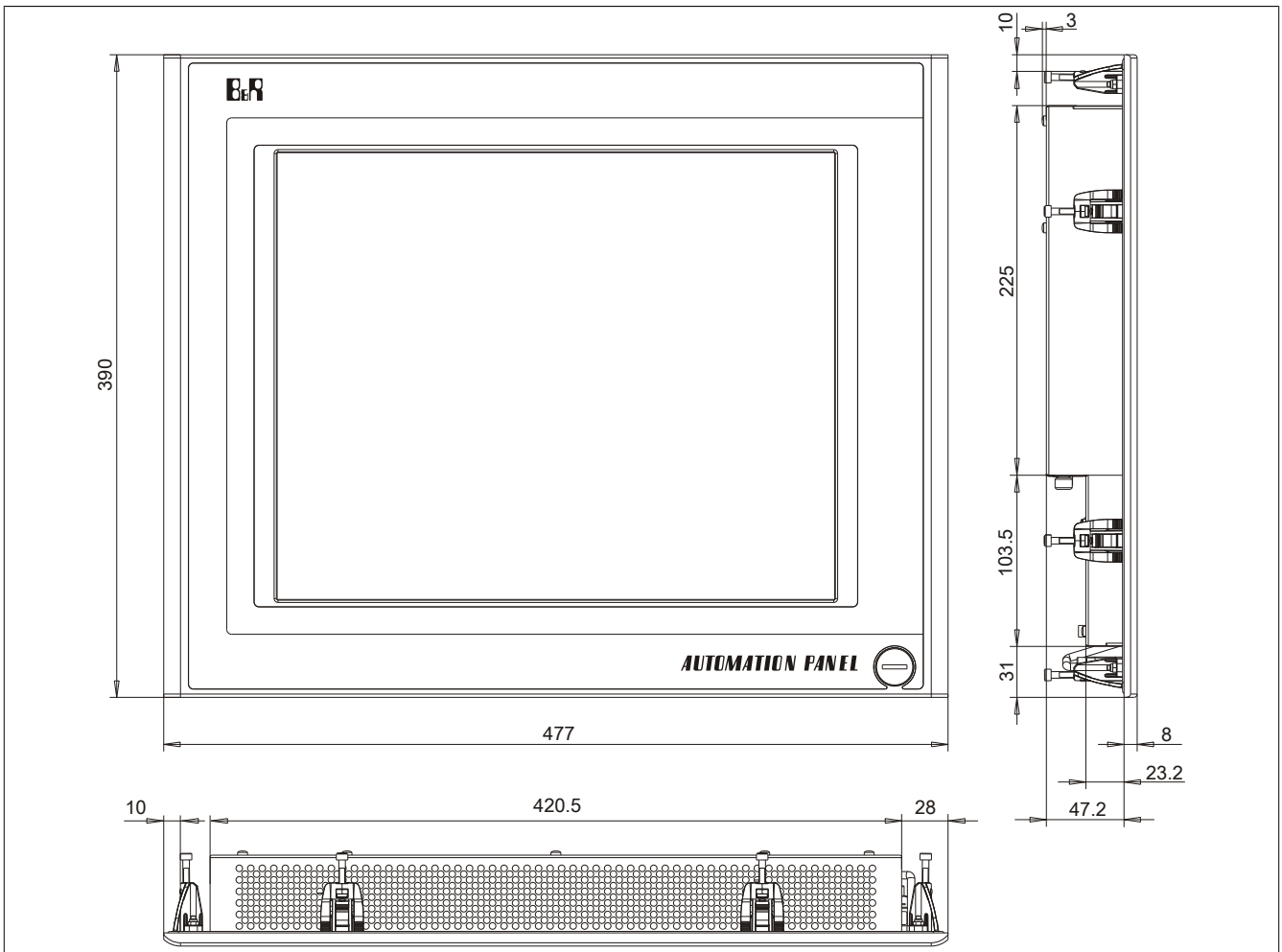

Figure 68: 5AP920.1706-01 - Dimensions

3.1.4.1.6 Cutout installation

The Automation Panel can be installed in a wall cutout using the pre-installed clamping blocks. To do so, it is necessary to make a cutout that corresponds to the following diagram.

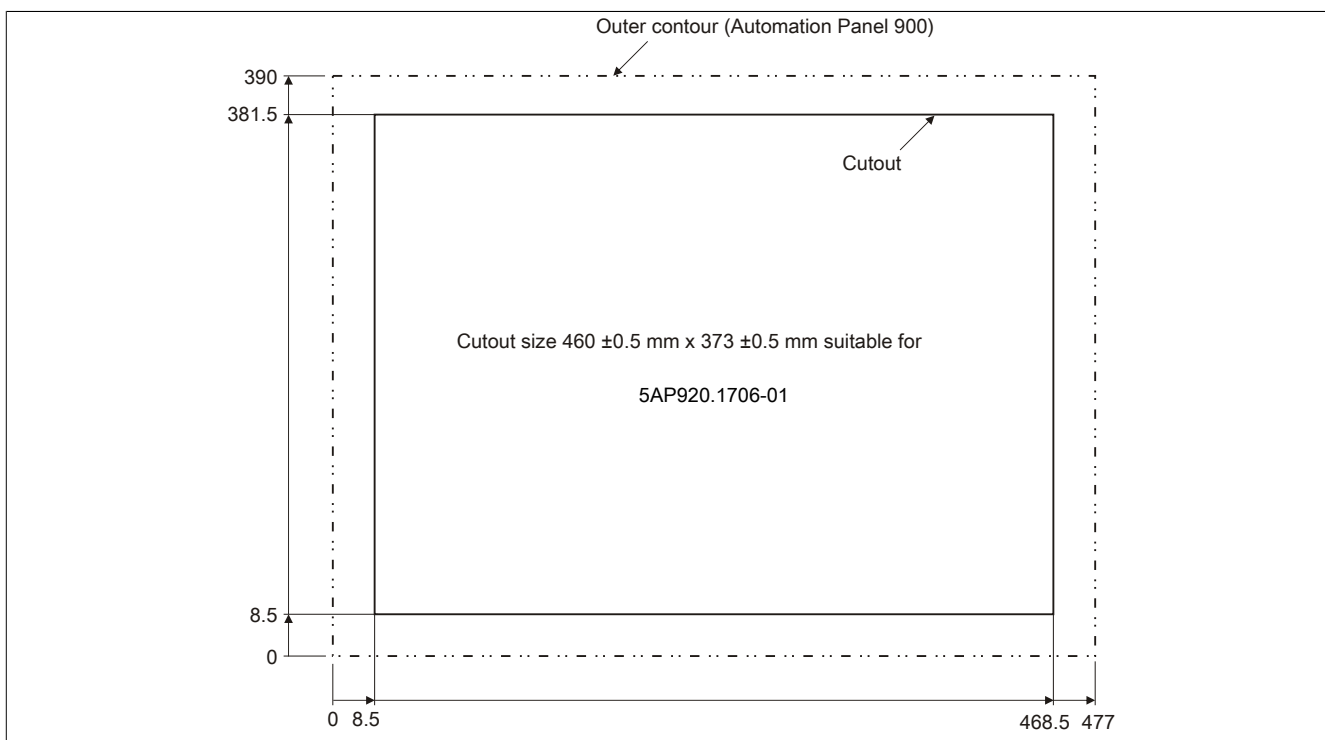

Figure 69: 5AP920.1706-01 - Cutout installation

For additional information regarding installation and mounting orientation, see "Installation" on page 109.

3.1.5 Automation Panel 19" SXGA

3.1.5.1 5AP920.1906-01

3.1.5.1.1 General information

- 19" TFT SXGA color display
- Analog resistive touch screen
- Small installation depth
- Fan-free operation
- Can be upgraded with Display Link cards or PPC300

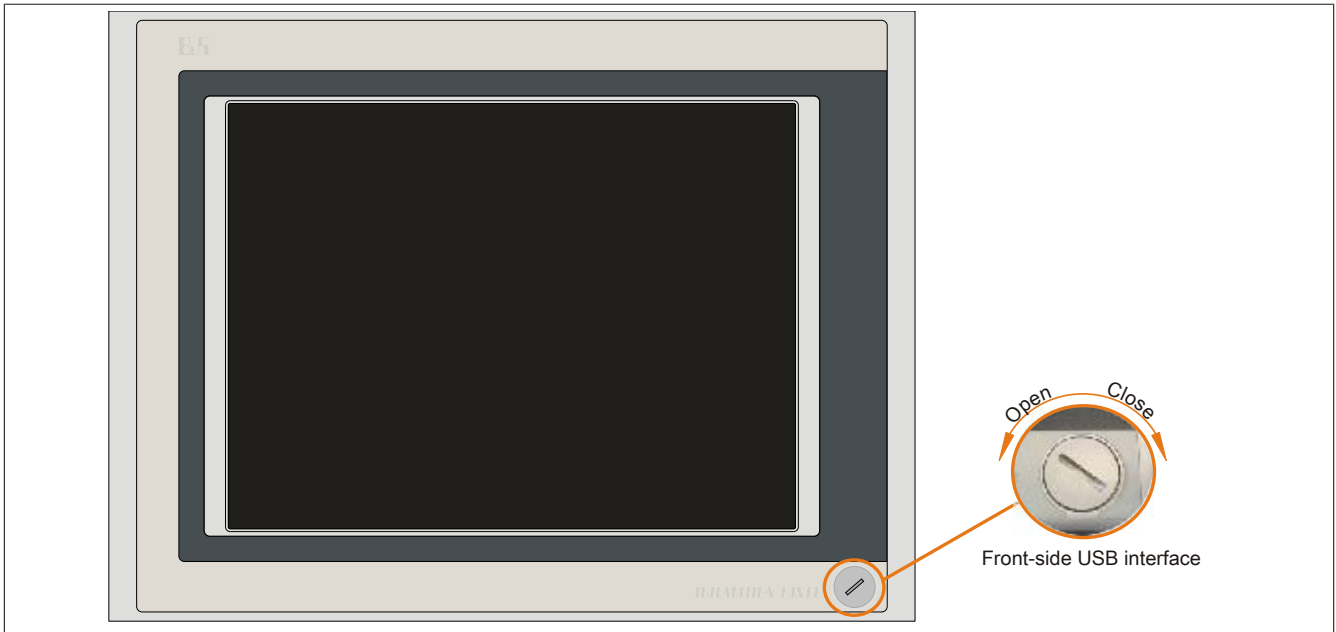

Figure 70: 5AP920.1906-01 - Front view

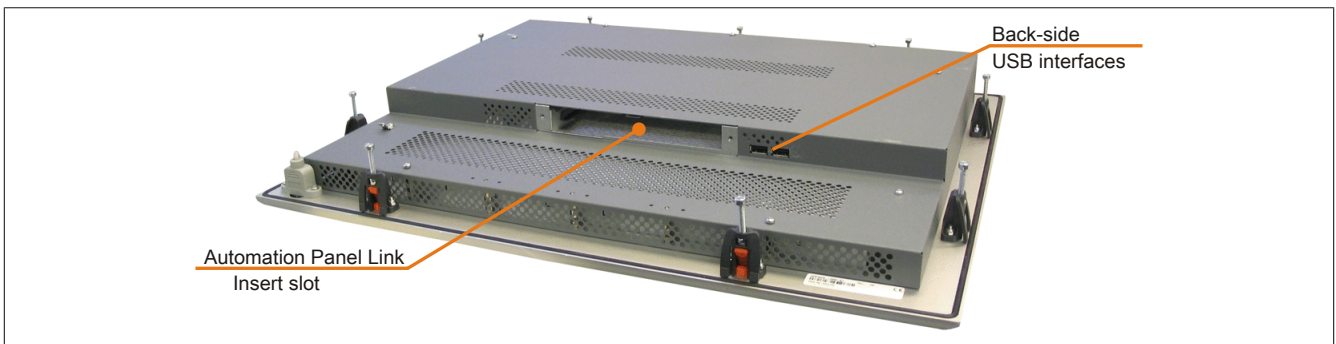

Figure 71: 5AP920.1906-01 - Rear view

3.1.5.1.2 Order data

Model number	Short description	Figure
	Display units	
5AP920.1906-01	Automation Panel AP920; 19" SXGA color TFT display with touch screen (resistive); 3 USB 2.0 interfaces; insert for Automation Panel Link; IP65 protection (from front). 24 VDC.	
	Required accessories	
	Display links	
5DLDVI.1000-01	Automation Panel Link DVI receiver; connections for DVI-D, RS232 and USB 2.0 (Type B); 24 VDC (order screw clamp 0TB103.9 or cage clamp 0TB103.91 separately).	
5DLS3.1000-00	Automation Panel Link SDL3 receiver - For Automation Panel 920/98x	
5DSDL.1000-00	Automation Panel Link SDL receiver; connection for SDL In; transmission of display, touch screen, USB 1.1, matrix key and service data; 24 VDC (order screw clamp 0TB103.9 or cage clamp 0TB103.91 separately).	

Table 33: 5AP920.1906-01 - Order data

Technical data • Individual components

Model number	Short description	Figure
5DLSDL.1000-01	Automation Panel Link SDL transceiver; connections for SDL In and SDL Out; transmission of display, touch screen, USB 1.1, matrix key and service data; 24 VDC (order screw clamp 0TB103.9 or cage clamp 0TB103.91 separately).	
	Terminal blocks	
0TB103.9	Connector 24 VDC - 3-pin female - Screw clamps 3.31 mm ²	
0TB103.91	Connector 24 VDC - 3-pin female - Cage clamps 3.31 mm ²	
	Optional accessories	
	Panel PC 300 insert cards	
5PC310.L800-00	Panel PC 300 insert card for the Automation Panel 900; 256 MB SDRAM; CompactFlash slot (Type I); 2x ETH 10/100; RS232; USB 2.0 (via integrated USB 2.0 interfaces on the Automation Panel); battery; 24 VDC (order screw clamp 0TB103.9 or cage clamp 0TB103.91 separately)	
5PC310.L800-01	Panel PC 300 insert card for the Automation Panel 900; 512 MB SDRAM; CompactFlash slot (Type I); 2x ETH 10/100; RS232; USB 2.0 (via integrated USB 2.0 interfaces on the Automation Panel); battery; 24 VDC (order screw clamp 0TB103.9 or cage clamp 0TB103.91 separately)	

Table 33: 5AP920.1906-01 - Order data

3.1.5.1.3 Technical data

Product ID	5AP920.1906-01			
Revision	C0	D0	O0	P0
General information				
B&R ID code	0x1A07			
Certification				
CE	Yes			
cULus	Yes			
GOST-R	Yes			
GL	Yes ¹⁾			
Interfaces				
USB ²⁾				
Quantity	3			
Type	USB 2.0 ³⁾			
Execution	Type A			
Transfer rate	Low speed (1.5 Mbit/s), full speed (12 Mbit/s), high speed (480 Mbit/s)			
Current load	Max. 500 mA per connection			
Display				
Type	TFT color			
Display size	19" (482 mm)			
Colors	16.7 million			
Resolution	SXGA, 1280 x 1024 pixels			
Contrast	600:1		1000:1	
Viewing angles				
Horizontal	Direction R = 75° / Direction L = 75°		Direction R = 89° / Direction L = 89°	
Vertical	Direction U = 75° / Direction D = 60°		Direction U = 89° / Direction D = 89°	
Backlight				
Type	CCFL		LED	
Brightness	250 cd/m ²		300 cd/m ²	
Half-brightness time ⁴⁾	35,000 h		50,000 h	
Filter glass				
Transmittance	-			
Coating	-			
Touch screen ⁵⁾				
Type	Elo AccuTouch	AMT		
Technology	Analog, resistive			
Controller	Elo, serial, 12-bit			
Transmittance	80% ±5%		81% ±3%	
Keys				
Function keys	No			
Soft keys	No			
System keys	No			
Service life	-			
LED brightness				
Yellow	-			
Inserts				
Compatible installation for PPC300 insert	Yes			
Electrical characteristics				
Nominal voltage	24 VDC ±25%			
Nominal current	Max. 3.2 A ⁶⁾			

Table 34: 5AP920.1906-01, 5AP920.1906-01, 5AP920.1906-01, 5AP920.1906-01 - Technical data

Product ID	5AP920.1906-01	
Starting current	Typ. 6 A, max. 30 A for <300 µs	
Power consumption	Typ. 27 W, max. 38 W or 48 W with USB (without insert)	
Electrical isolation	Yes	
Operating conditions		
EN 60529 protection	Back: IP20 (only with an inserted Automation Panel Link card) Front: IP65 / NEMA 250 type 4X indoor, dust and sprayed water protection	
Environmental conditions		
Temperature Operation	Without Rittal housing Mounting orientation 0°: 0 to 40°C Mounting orientations to -45° display above: 0 to 40°C Mounting orientations to +45° display below: 0 to 40°C	
Storage	-20 to 60°C	-25 to 60°C
Transport	-20 to 60°C	-25 to 60°C
Vibration	2 to 9 Hz: 1.75 mm amplitude / 9 to 200 Hz: 0.5 g 2 to 9 Hz: 3.5 mm amplitude / 9 to 200 Hz: 1 g	
Operation (continuous)	2 to 8 Hz: 7.5 mm amplitude / 8 to 200 Hz: 2 g / 200 to 500 Hz: 4 g	
Operation (occasional)	2 to 8 Hz: 7.5 mm amplitude / 8 to 200 Hz: 2 g / 200 to 500 Hz: 4 g	
Storage	2 to 8 Hz: 7.5 mm amplitude / 8 to 200 Hz: 2 g / 200 to 500 Hz: 4 g	
Transport	2 to 8 Hz: 7.5 mm amplitude / 8 to 200 Hz: 2 g / 200 to 500 Hz: 4 g	
Shock	15 g, 11 ms	
Operation	30 g, 15 ms	
Storage	30 g, 15 ms	
Transport	30 g, 15 ms	
Altitude	Max. 3000 m ⁷⁾	
Operation		
Mechanical characteristics		
Housing	Metal	
Material	Similar to Pantone 432CV	
Paint		
Front ⁸⁾	Naturally anodized aluminum	
Frame	Gray	
Design		
Panel overlay	Polyester	
Material	Similar to Pantone 427CV	
Light background	Similar to Pantone 432CV	
Dark gray border around display	Flat gasket around display front	
Gasket		
Dimensions		
Width	527 mm	
Height	421 mm	
Depth	62 mm	
Weight	Approx. 8100 g	

Table 34: 5AP920.1906-01, 5AP920.1906-01, 5AP920.1906-01, 5AP920.1906-01 - Technical data

- 1) Yes, although applies only if all components installed within the complete system have this certification
- 2) USB devices can only be connected to the Automation Panel directly (i.e. without a hub).
- 3) Depends on the transmission technology, the transfer distance and the Automation Panel Link insert card being used.
- 4) At an ambient temperature of 25°C. Reducing the brightness by 50% can result in an approximately 50% increase in the half-brightness time.
- 5) Touch screen drivers for approved operating systems are available in the Downloads section of the B&R website.
- 6) The specified value applies to Automation Panel systems with an inserted Automation Panel Link card.
- 7) The maximum ambient temperature is typically derated by 1°C per 1000 meters (starting at 500 meters above sea level).
- 8) There may be visible deviations in the color and surface appearance depending on the process or batch.

3.1.5.1.4 Temperature humidity diagram

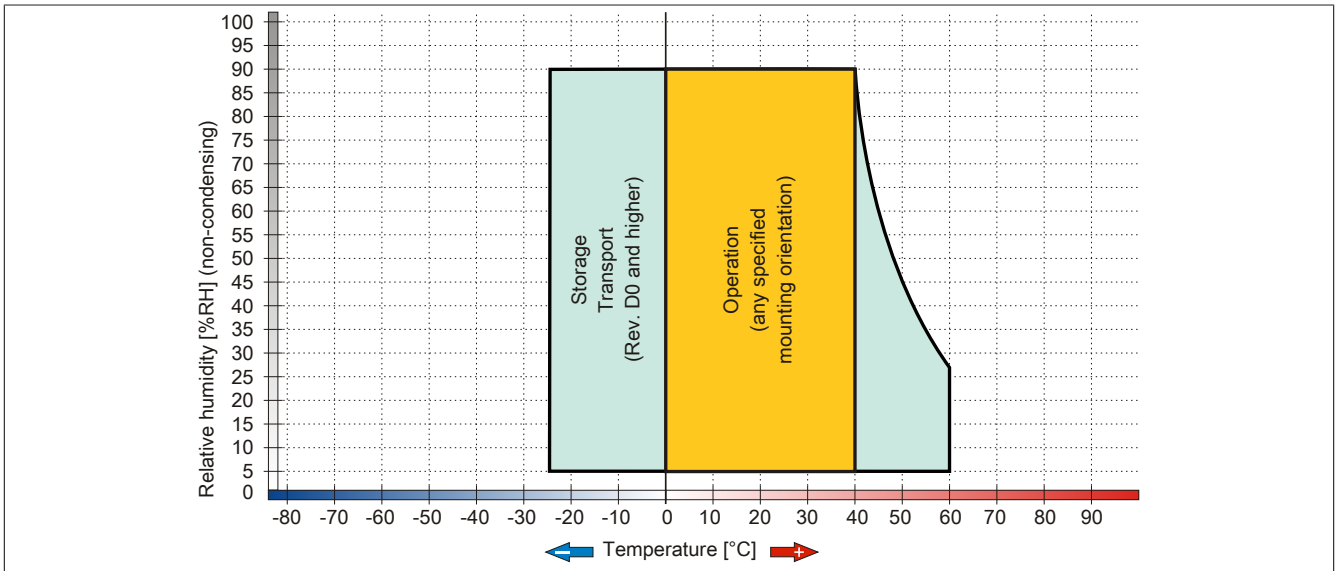

Figure 72: 5AP920.1906-01 - Temperature humidity diagram

3.1.5.1.5 Dimensions

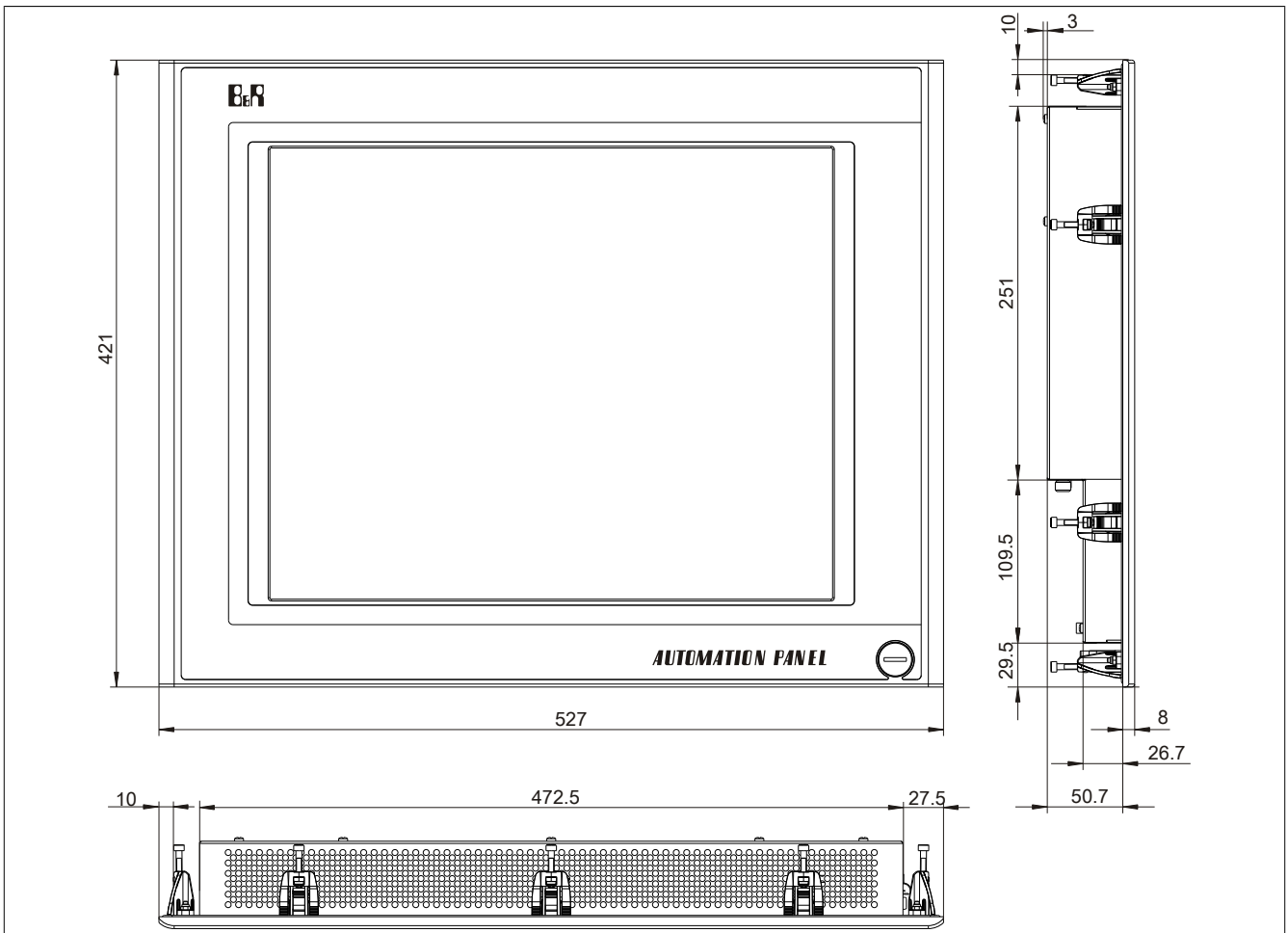

Figure 73: 5AP920.1906-01 - Dimensions

3.1.5.1.6 Cutout installation

The Automation Panel can be installed in a wall cutout using the pre-installed clamping blocks. To do so, it is necessary to make a cutout that corresponds to the following diagram.

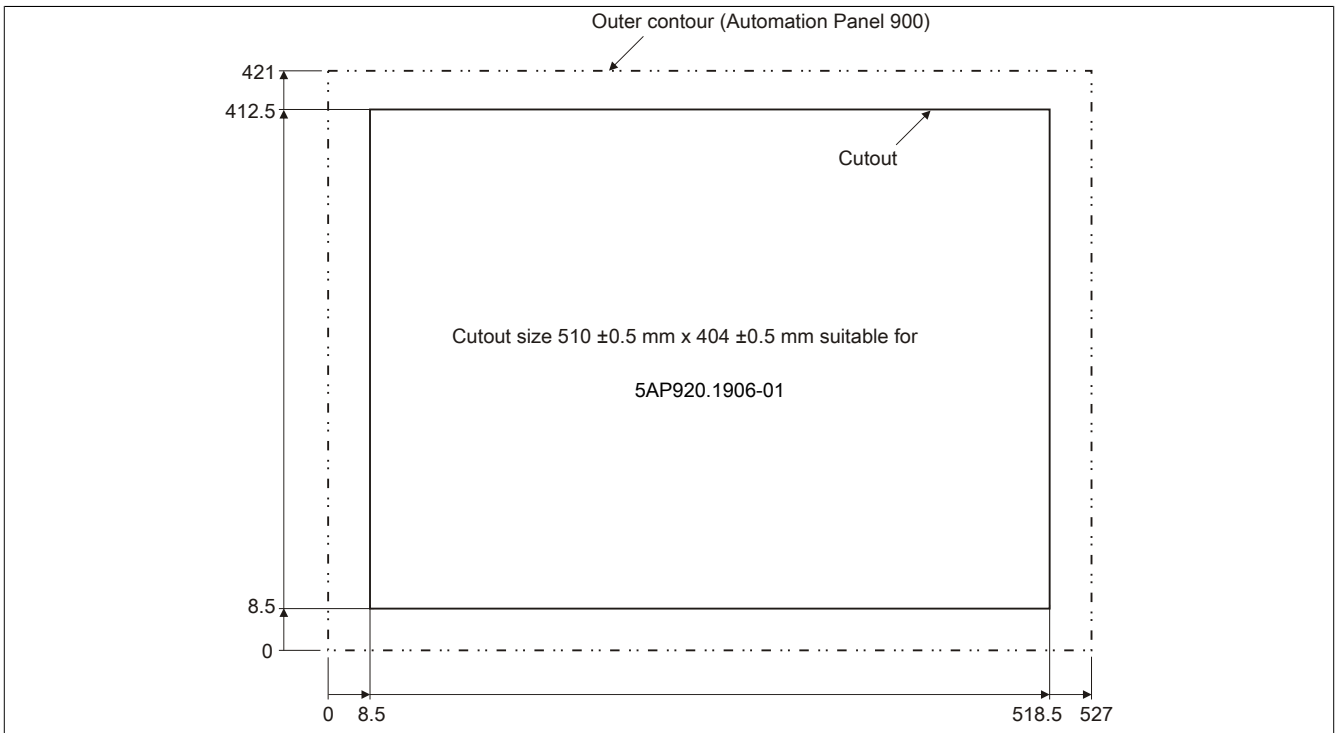

Figure 74: 5AP920.1906-01 - Cutout installation

For additional information regarding installation and mounting orientation, see "Installation" on page 109.

3.1.6 Automation Panel 21.3" UXGA

3.1.6.1 5AP920.2138-01

3.1.6.1.1 General information

- 21.3" UXGA color TFT display
- Analog resistive touch screen
- Small installation depth
- Fan-free operation
- Can be upgraded with Display Link cards or PPC300

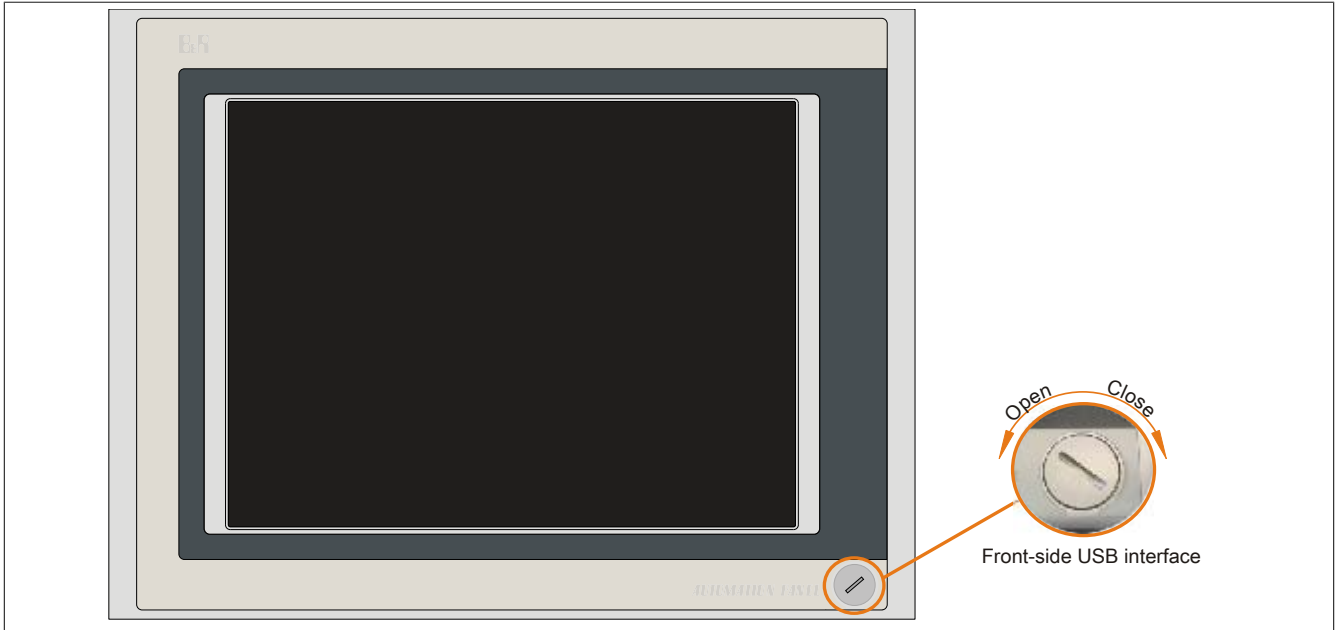

Figure 75: 5AP920.2138-01 - Front view

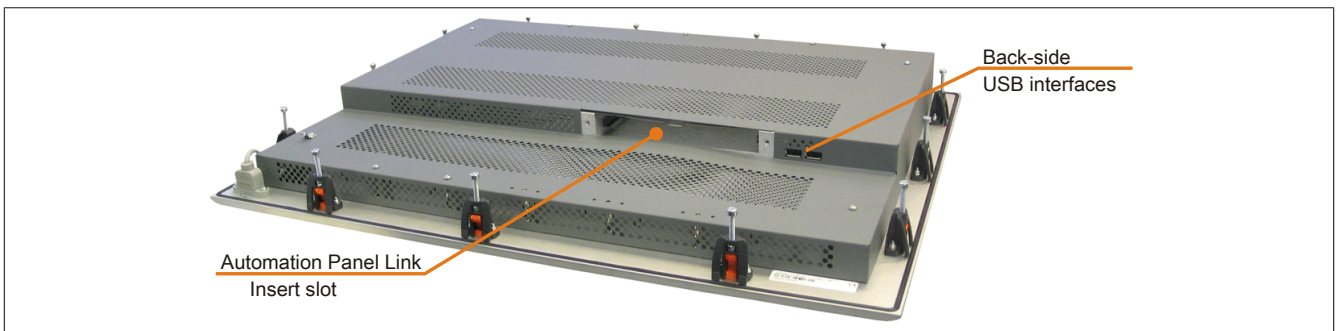

Figure 76: 5AP920.2138-01 - Rear view

3.1.6.1.2 Order data

Model number	Short description	Figure
Display units		
5AP920.2138-01	Automation Panel AP920 21.3" UXGA color TFT display with touch screen (resistive); 3 USB 2.0 interfaces; insert for Automation Panel Link; IP65 protection (front). 24VDC.	
Required accessories		
Display links		
5DLDVI.1000-01	Automation Panel Link DVI receiver; connections for DVI-D, RS232 and USB 2.0 (Type B); 24 VDC (order screw clamp 0TB103.9 or cage clamp 0TB103.91 separately).	
5DLSDL.1000-00	Automation Panel Link SDL receiver; connection for SDL In; transmission of display, touch screen, USB 1.1, matrix key and service data; 24 VDC (order screw clamp 0TB103.9 or cage clamp 0TB103.91 separately).	
5DLSDL.1000-01	Automation Panel Link SDL transceiver; connections for SDL In and SDL Out; transmission of display, touch screen, USB 1.1, matrix key and service data; 24 VDC (order screw clamp 0TB103.9 or cage clamp 0TB103.91 separately).	
Terminal blocks		
0TB103.9	Connector 24 VDC - 3-pin female - Screw clamps 3.31 mm ²	
0TB103.91	Connector 24 VDC - 3-pin female - Cage clamps 3.31 mm ²	

Table 35: 5AP920.2138-01 - Order data

3.1.6.1.3 Technical data

Product ID	5AP920.2138-01
General information	
B&R ID code	0x1A08
Certification	
CE	Yes
cULus	Yes
Interfaces	
USB ¹⁾	
Quantity	3
Type	USB 2.0 ²⁾
Execution	Type A
Transfer rate	Low speed (1.5 Mbit/s), full speed (12 Mbit/s), high speed (480 Mbit/s)
Current load	Max. 500 mA per connection
Display	
Type	Color TFT
Display size	21.3" (641 mm)
Colors	16.7 million
Resolution	UXGA, 1600 x 1200 pixels
Contrast	500:1
Viewing angles	
Horizontal	Direction R = 60° / Direction L = 60°
Vertical	Direction U = 60° / Direction D = 60°
Backlight	
Type	CCFL
Brightness	250 cd/m ²
Half-brightness time ³⁾	50,000 h
Filter glass	
Transmittance	-
Coating	-
Touch screen ⁴⁾	
Type	Elo AccuTouch
Technology	Analog, resistive
Controller	Elo, serial, 12-bit
Transmittance	80% ±5%
Keys	
Function keys	No
Soft keys	No
System keys	No
Service life	-
LED brightness	
Yellow	-
Electrical characteristics	
Nominal voltage	24 VDC ±25%
Nominal current	Max. 42 A ⁵⁾
Starting current	Typ. 8 A, max. 40 A for < 300 μs
Power consumption	Typ. 50 W, max. 63 W or 73 W with USB (without insert)
Electrical isolation	Yes

Table 36: 5AP920.2138-01 - Technical data

Product ID	5AP920.2138-01
Operating conditions	
EN 60529 protection	Back: IP20 (only with an inserted Automation Panel Link card) Front: IP65 / NEMA 250 type 4X indoor, dust and sprayed water protection
Environmental conditions	
Temperature	
Operation	Without Rittal housing Mounting orientation 0°: 0 to 35°C Mounting orientations to -45° display above: 0 to 35°C Mounting orientations to +45° display below: 0 to 30°C
Storage	-20 to 60°C
Transport	-20 to 60°C
Vibration	
Operation (continuous)	2 to 9 Hz: 1.75 mm amplitude / 9 to 200 Hz: 0.5 g
Operation (occasional)	2 to 9 Hz: 3.5 mm amplitude / 9 to 200 Hz: 1 g
Storage	2 to 8 Hz: 7.5 mm amplitude / 8 to 200 Hz: 2 g / 200 to 500 Hz: 4 g
Transport	2 to 8 Hz: 7.5 mm amplitude / 8 to 200 Hz: 2 g / 200 to 500 Hz: 4 g
Shock	
Operation	15 g, 11 ms
Storage	30 g, 15 ms
Transport	30 g, 15 ms
Altitude	
Operation	Max. 3000 m ⁶⁾
Mechanical characteristics	
Housing	
Material	Metal
Paint	Similar to Pantone 432CV
Front ⁷⁾	
Frame	Naturally anodized aluminum
Design	Gray
Panel overlay	
Material	Polyester
Light background	Similar to Pantone 427CV
Dark gray border around display	Similar to Pantone 432CV
Gasket	Flat gasket around display front
Dimensions	
Width	583 mm
Height	464 mm
Depth	64 mm
Weight	Approx. 11000 g

Table 36: 5AP920.2138-01 - Technical data

- 1) USB devices can only be connected to the Automation Panel directly (i.e. without a hub).
- 2) Depends on the transmission technology, the transfer distance and the Automation Panel Link plug-in card being used.
- 3) At an ambient temperature of 25°C. Reducing the brightness by 50% can result in an approximately 50% increase in the half-brightness time.
- 4) Touch screen drivers for approved operating systems are available in the Downloads section of the B&R website.
- 5) The specified value applies to Automation Panel systems with an inserted Automation Panel Link card.
- 6) The maximum ambient temperature is typically derated by 1°C per 1000 meters (starting at 500 meters above sea level).
- 7) There may be visible deviations in the color and surface appearance depending on the process or batch.

3.1.6.1.4 Temperature humidity diagram

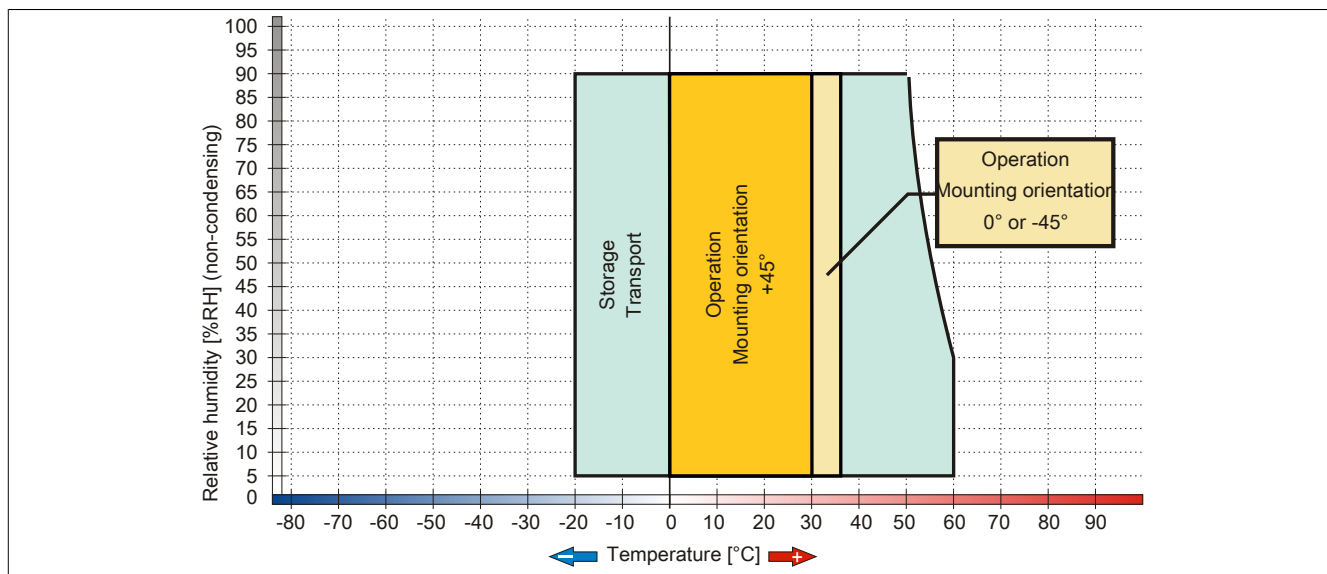

Figure 77: 5AP920.2138-01 - Temperature humidity diagram

3.1.6.1.5 Dimensions

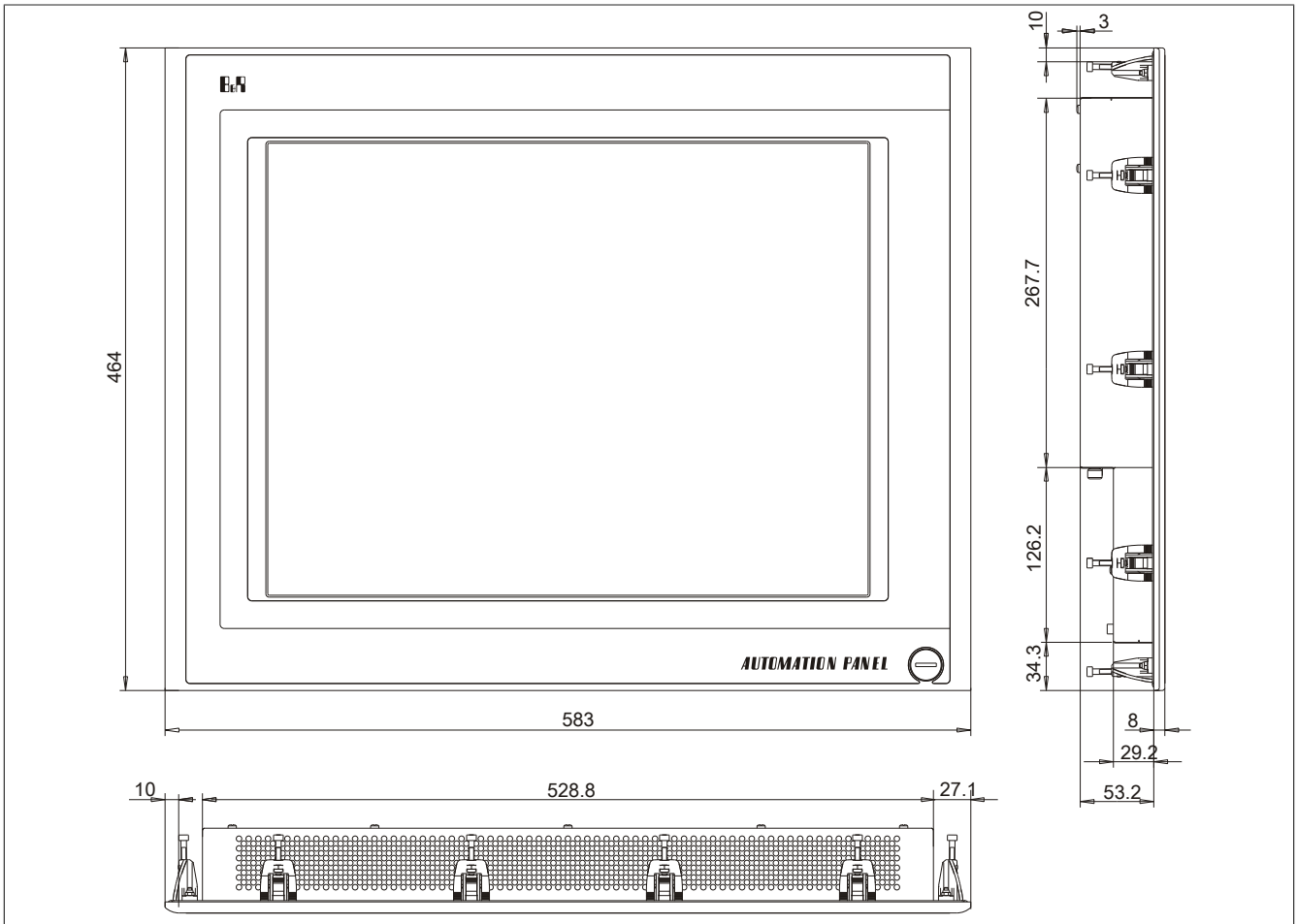

Figure 78: 5AP920.2138-01 - Dimensions

3.1.6.1.6 Cutout installation

The Automation Panel can be installed in a wall cutout using the pre-installed clamping blocks. To do so, it is necessary to make a cutout that corresponds to the following diagram.

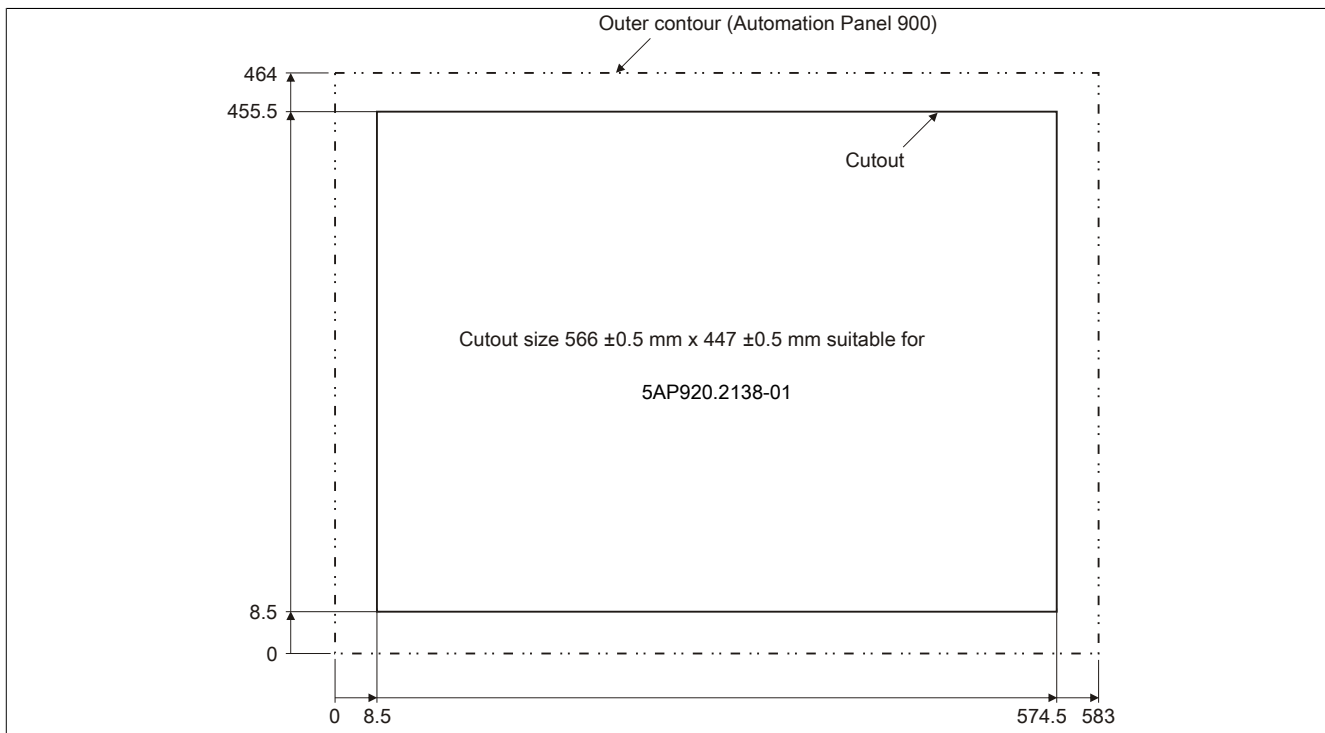

Figure 79: 5AP920.2138-01 - Cutout installation

For additional information regarding installation and mounting orientation, see "Installation" on page 109.

3.2 Automation Panel Link plug-in cards

Automation Panel Link plug-in cards provide the interface between a B&R Industrial PC and the Automation Panel 900. These cards receive and process the graphics signals from the B&R Industrial PC (e.g. via the Automation PC 810 monitor/panel output) and pass them along to the Automation Panel 900. Touch screen, USB and SDL data is transferred in the other direction to the respective interface on the B&R Industrial PC (e.g. Automation PC 810) via the cable.

A plug-in card is simply inserted into the Automation Panel 900 slot provided and fastened into place using the two locating screws (max. tightening torque 0.5 Nm).

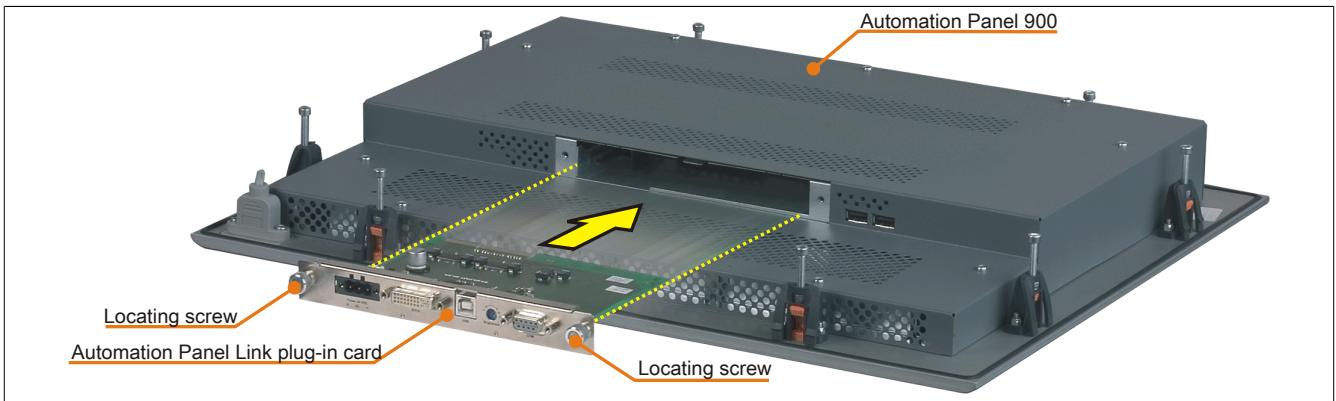

Figure 80: Automation Panel and Automation Panel Link plug-in card

3.2.1 5DLDVI.1000-01

3.2.1.1 General information

DVI stands for Digital Video Interface. DVI Link is the first choice whenever compatibility with a standard is important. With a DVI connection, the Automation Panel can also be used universally with systems from other manufacturers. This type of transfer supports the transmission of display data, USB 2.0 data and touch screen data over separate cables for each.

- Can be used in all Automation Panel 900 devices
- DVI-D, RS232 and USB 2.0 connections

3.2.1.2 Order data

Model number	Short description	Figure
5DLDVI.1000-01	Automation Panel Link DVI receiver; connections for DVI-D, RS232 and USB 2.0 (Type B); 24 VDC (order screw clamp 0TB103.9 or cage clamp 0TB103.91 separately).	
	Required accessories	
	DVI cables	
5CADVI.0018-00	DVI-D cable - 1.8 m	
5CADVI.0050-00	DVI-D cable - 5 m	
5CADVI.0100-00	DVI-D cable - 10 m	
	Terminal blocks	
0TB103.9	Connector 24 VDC - 3-pin female - Screw clamps 3.31 mm ²	
0TB103.91	Connector 24 VDC - 3-pin female - Cage clamps 3.31 mm ²	
	Optional accessories	
	RS232 cables	
9A0014.02	RS232 extension cable for remote operation of a display unit with touch screen, 1.8 m	
9A0014.05	RS232 extension cable for remote operation of a display unit with touch screen, 5 m	
	USB cables	
5CAUSB.0018-00	USB 2.0 connection cable type A - type B, 1.8 m	
5CAUSB.0050-00	USB 2.0 connection cable type A - type B, 5 m	

Table 37: 5DLDVI.1000-01 - Order data

3.2.1.3 Technical data

Product ID	5DLDVI.1000-01
General information	
BL adjuster ¹⁾	Yes
B&R ID code	0x1A0B
Certification	
CE	Yes
cULus	Yes
GOST-R	Yes
GL	Yes ²⁾
Interfaces	
COM1	
Type	RS232, not electrically isolated
Execution	9-pin DSUB connector
Max. baud rate	115 kbit/s
USB	
Quantity	1
Type	USB 2.0 if cable length ≤5 m USB 1.1 if cable length >5 m
Execution	Type B
Panel In	
Execution	Female DVI-D connector
Type	SDL/DVI
Electrical characteristics	
Nominal voltage	24 VDC ±25%
Nominal current ³⁾	Max. 4.2 A
Power consumption	Typ. 3 W

Table 38: 5DLDVI.1000-01 - Technical data

Product ID	5DLDVI.1000-01
Mechanical characteristics	
Locating screws	
Quantity	2
Max. tightening torque	0.5 Nm

Table 38: 5DLDVI.1000-01 - Technical data

- 1) Used to set the brightness of the backlight on the AP900.
- 2) Yes, although applies only if all components installed within the complete system have this certification
- 3) The specified value applies to an Automation Panel Link card being used in a 19" Automation Panel system.

3.2.1.4 Interfaces

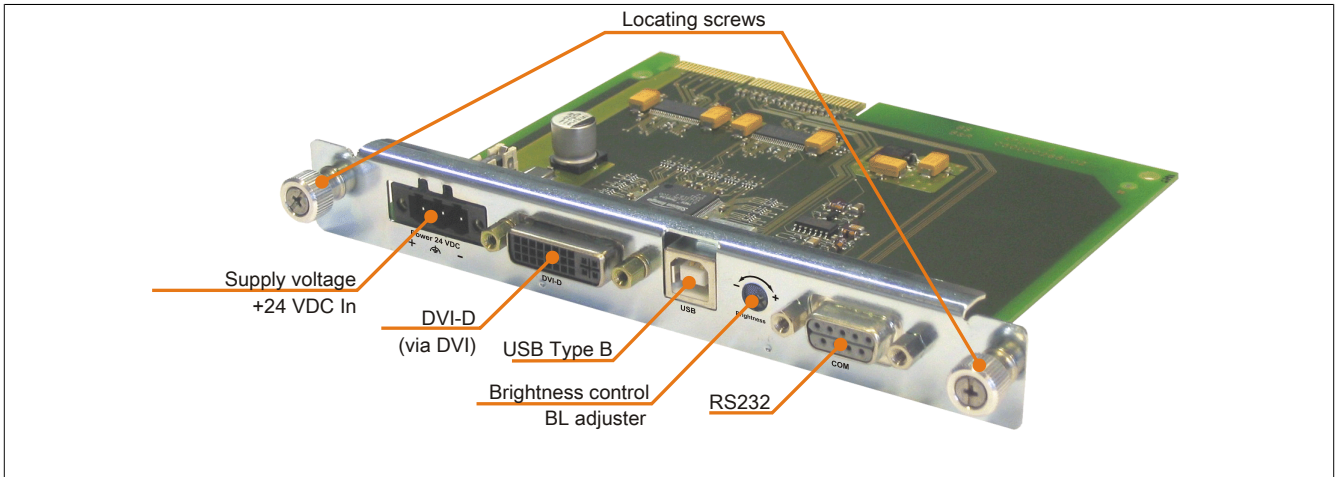

Figure 81: 5DLDVI.1000-01 - Interfaces

3.2.1.4.1 DVI-D

The Display Link insert card has one DVI digital input. As a result, only the digital signals from one graphics adapter connected with a single DVI digital cable can be processed. B&R offers DVI cables up to 10 meters in length (see "Cables" on page 155).

3.2.1.4.2 USB Type B

The USB Type B connector makes it possible to use a USB connection cable (B&R offers USB cables up to 5 meters in length, see "Cables" on page 155) to connect the Display Link insert card with a USB Type A output (e.g. on a B&R Slot CPU, B&R APC620 / APC810, B&R graphics adapter, etc.).

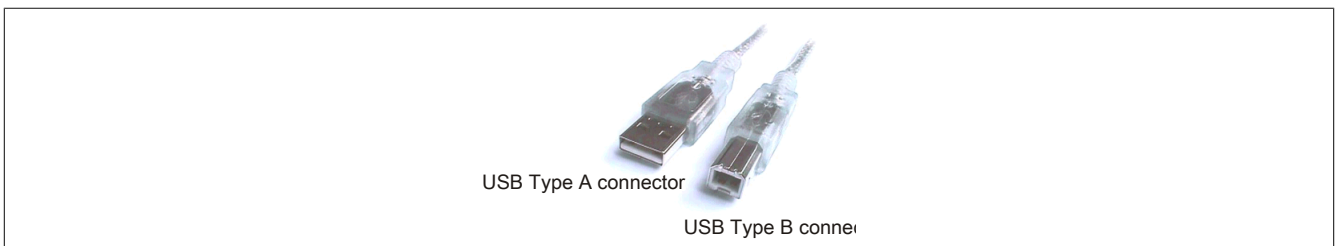

Figure 82: Comparison of USB Type A/B connectors

If the Display Link is connected correctly, then the Automation Panel 900 is equipped with one or more (depending on the type) USB ports (front and back).

Information:

USB 2.0 is supported for cables up to 5 meters in length.

3.2.1.4.3 BL adjuster

This adjuster can be used to control the brightness of the backlight on the Automation Panel 900.

3.2.1.4.4 COM Serial interface

The RS232 interface is used to transfer signals from the Automation Panel 900 touch screen.

B&R offers RS232 cables up to 10 meters in length (see "Cables" on page 155).

COM serial interface	
RS232	
Type	RS232, not electrically isolated
UART	16550-compatible, 16-byte FIFO
Transfer rate	Max. 115 kbit/s
Bus length	Max. 15 m
Pin	Assignment
1	NC
2	RXD
3	TXD
4	NC
5	GND
6	DSR
7	RTS
8	CTS
9	NC

9-pin DSUB connector

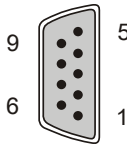

Table 39: COM - Pinout

3.2.1.4.5 +24 VDC supply voltage

The 3-pin connector required for the supply voltage connection is not included in delivery. It can be ordered from B&R using model number 0TB103.9 (screw clamp) or 0TB103.91 (cage clamp).

The pinout is listed in the following table and printed on the DVI receiver. When dimensioning the power supply, the maximum power consumption of the Automation Panel being used must be taken into consideration (see 2 "Technical data" on page 17).

Supply voltage	
Protected against reverse polarity	
Pin	Description
1	+
2	Functional ground
3	-
Required accessories	
Terminal blocks	
0TB103.9	Connector 24 V 5.08 3-pin screw clamp
0TB103.91	Connector 24 V 5.08 3-pin cage clamp

3-pin, male

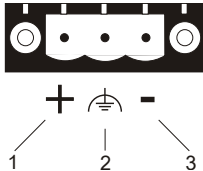

Table 40: Supply voltage connection 24 VDC

3.2.1.4.6 Grounding

The supply voltage connection (pin 2) must be connected to the ground using the largest possible wire (min. 2.5 mm²) via the shortest distance and with as little resistance as possible.

3.2.2 5DLSDL.1000-00

3.2.2.1 General information

SDL stands for "Smart Display Link". SDL allows all communication between the Automation Panel and a B&R Industrial PC to be handled using a single cable. In addition to display data, it also transmits touch screen, matrix key, LED and service data. The Automation Panel can be installed up to 40 m from the B&R Industrial PC. USB 1.1 is fully integrated in SDL and transferred over this distance as well without the need for external modules. A panel can be operated on a line using an SDL receiver.

- Can be used in all Automation Panel 900 devices
- SDL IN connections

3.2.2.2 Order data

Model number	Short description	Figure
	Display links	
5DLSDL.1000-00	Automation Panel Link SDL receiver; connection for SDL In; transmission of display, touch screen, USB 1.1, matrix key and service data; 24 VDC (order screw clamp 0TB103.9 or cage clamp 0TB103.91 separately).	
	Required accessories	
	SDL cables with 45° connectors	
5CASDL.0018-01	SDL cable - 45° connector - 1.8 m	
5CASDL.0050-01	SDL cable with 45° male connector, 5 m	
5CASDL.0100-01	SDL cable with 45° male connector, 10 m	
	SDL flex cables	
5CASDL.0018-03	SDL flex cable - 1.8 m	
5CASDL.0050-03	SDL flex cable, 5 m	
5CASDL.0100-03	SDL flex cable, 10 m	
5CASDL.0150-03	SDL flex cable, 15 m	
5CASDL.0200-03	SDL flex cable, 20 m	
5CASDL.0250-03	SDL flex cable, 25 m	
5CASDL.0300-03	SDL flex cable, 30 m	
5CASDL.0300-13	SDL flex cable with extender, 30 m	
5CASDL.0400-13	SDL flex cable with extender, 40 m	
	Terminal blocks	
0TB103.9	Connector 24 VDC - 3-pin female - Screw clamps 3.31 mm ²	
0TB103.91	Connector 24 VDC - 3-pin female - Cage clamps 3.31 mm ²	

Table 41: 5DLSDL.1000-00 - Order data

3.2.2.3 Technical data

Product ID	5DLSDL.1000-00
General information	
BL adjuster ¹⁾	No
B&R ID code	0x1C53
Certification	
CE	Yes
cULus	Yes
GOST-R	Yes
GL	Yes ²⁾
Interfaces	
Monitor/Panel interface	
Panel IN	SDL
Panel OUT	-
Electrical characteristics	
Nominal voltage	24 VDC ±25%
Nominal current ³⁾	Max. 4.2 A
Power consumption	Typ. 3 W
Mechanical characteristics	
Locating screws	
Quantity	2
Max. tightening torque	0.5 Nm

Table 42: 5DLSDL.1000-00 - Technical data

- 1) Used to set the brightness of the backlight on the AP900.
- 2) Yes, although applies only if all components installed within the complete system have this certification
- 3) The specified value applies to an Automation Panel Link card being used in a 19" Automation Panel system.

3.2.2.4 Interfaces

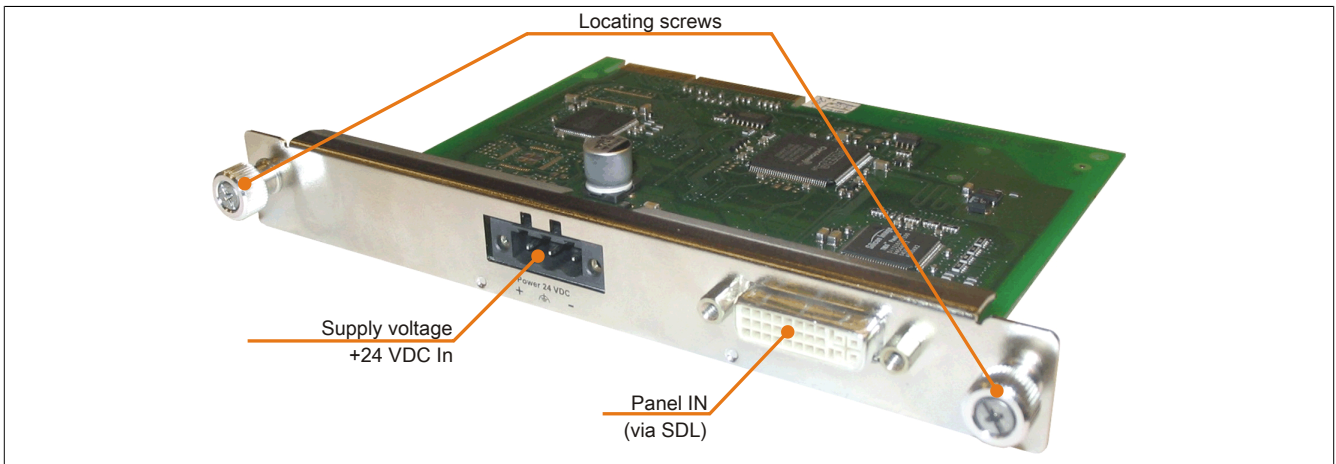

Figure 83: 5DLSDL.1000-00 - Interfaces

3.2.2.4.1 +24 VDC supply voltage

The 3-pin connector required for the supply voltage connection is not included in delivery. It can be ordered from B&R using model number 0TB103.9 (screw clamp) or 0TB103.91 (cage clamp).

The pinout is listed in the following table and printed on the DVI receiver. When dimensioning the power supply, the maximum power consumption of the Automation Panel being used must be taken into consideration (see 2 "Technical data" on page 17).

Supply voltage		3-pin, male
Protected against reverse polarity		
Pin	Description	
1	+	
2	Functional ground	
3	-	
Required accessories		
Terminal blocks		
0TB103.9	Connector 24 V 5.08 3-pin screw clamp	
0TB103.91	Connector 24 V 5.08 3-pin cage clamp	

Table 43: Supply voltage connection 24 VDC

3.2.2.4.2 Grounding

The supply voltage connection (pin 2) must be connected to the ground using the largest possible wire (min. 2.5 mm²) via the shortest distance and with as little resistance as possible.

3.2.2.4.3 Panel IN

This interface is intended for the SDL connection to a B&R Industrial PC. The necessary SDL cables are available separately from B&R (see "Cables" on page 155).

3.2.3 5DLSDL.1000-01

3.2.3.1 General information

This SDL transceiver makes it possible to connect an additional Automation Panel to the first Automation Panel. The second segment also provides an additional 40 meters in length although the maximum distance may be limited by the resolution. To achieve the maximum segment length, it is possible to use cables with an integrated extender that acts as an amplifier. Additional hardware is not required.

- Can be used in all Automation Panel 900 devices
- SDL IN and SDL OUT connections

3.2.3.2 Order data

Model number	Short description	Figure
	Display links	
5DLSDL.1000-01	Automation Panel Link SDL transceiver; connections for SDL In and SDL Out; transmission of display, touch screen, USB 1.1, matrix key and service data; 24 VDC (order screw clamp 0TB103.9 or cage clamp 0TB103.91 separately).	
	Required accessories	
	SDL cables with 45° connectors	
5CASDL.0018-01	SDL cable - 45° connector - 1.8 m	
5CASDL.0050-01	SDL cable with 45° male connector, 5 m	
5CASDL.0100-01	SDL cable with 45° male connector, 10 m	
	SDL flex cables	
5CASDL.0018-03	SDL flex cable - 1.8 m	
5CASDL.0050-03	SDL flex cable, 5 m	
5CASDL.0100-03	SDL flex cable, 10 m	
5CASDL.0150-03	SDL flex cable, 15 m	
5CASDL.0200-03	SDL flex cable, 20 m	
5CASDL.0250-03	SDL flex cable, 25 m	
5CASDL.0300-03	SDL flex cable, 30 m	
5CASDL.0300-13	SDL flex cable with extender, 30 m	
5CASDL.0400-13	SDL flex cable with extender, 40 m	
	Terminal blocks	
0TB103.9	Connector 24 VDC - 3-pin female - Screw clamps 3.31 mm ²	
0TB103.91	Connector 24 VDC - 3-pin female - Cage clamps 3.31 mm ²	

Table 44: 5DLSDL.1000-01 - Order data

3.2.3.3 Technical data

Product ID	5DLSDL.1000-01
General information	
BL adjuster ¹⁾	No
B&R ID code	0x1C52
Certification	
CE	Yes
cULus	Yes
GOST-R	Yes
Interfaces	
Monitor/Panel interface	
Panel IN	SDL
Panel OUT	SDL
Electrical characteristics	
Nominal voltage	24 VDC ±25%
Nominal current ²⁾	Max. 4.2 A
Power consumption	Typ. 3 W
Mechanical characteristics	
Locating screws	
Quantity	2
Max. tightening torque	0.5 Nm

Table 45: 5DLSDL.1000-01 - Technical data

1) Used to set the brightness of the backlight on the AP900.

2) The specified value applies to an Automation Panel Link card being used in a 19" Automation Panel system.

3.2.3.4 Interfaces

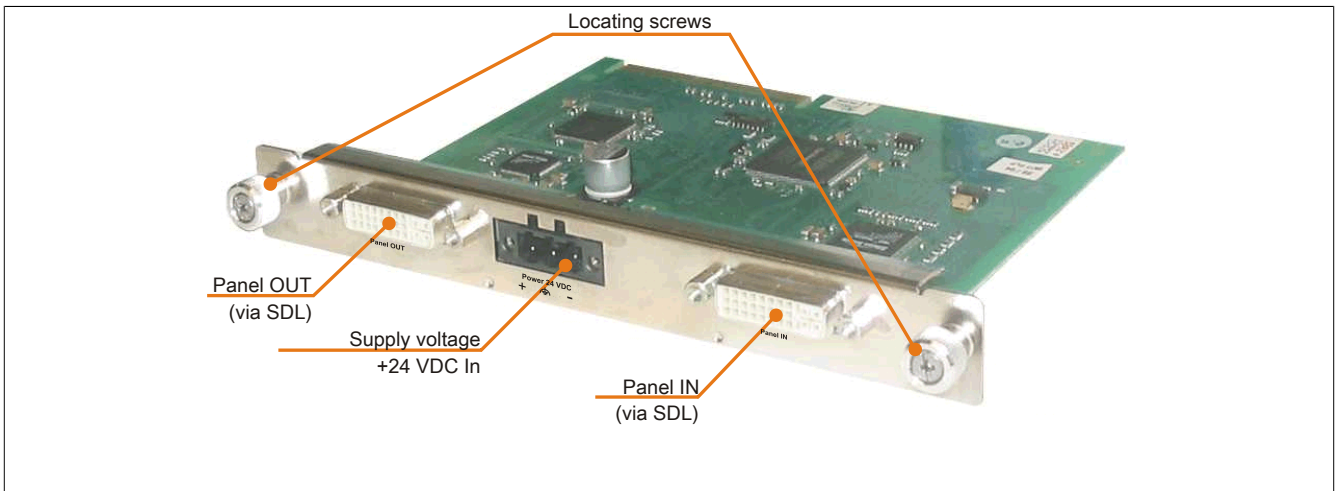

Figure 84: 5DLSDL.1000-01 - Interfaces

3.2.3.4.1 +24 VDC supply voltage

The 3-pin connector required for the supply voltage connection is not included in delivery. It can be ordered from B&R using model number 0TB103.9 (screw clamp) or 0TB103.91 (cage clamp).

The pinout is listed in the following table and printed on the DVI receiver. When dimensioning the power supply, the maximum power consumption of the Automation Panel being used must be taken into consideration (see 2 "Technical data" on page 17).

Supply voltage	
Protected against reverse polarity	
Pin	Description
1	+
2	Functional ground
3	-
Required accessories	
Terminal blocks	
0TB103.9	Connector 24 V 5.08 3-pin screw clamp
0TB103.91	Connector 24 V 5.08 3-pin cage clamp

3-pin, male

Table 46: Supply voltage connection 24 VDC

3.2.3.4.2 Grounding

The supply voltage connection (pin 2) must be connected to the ground using the largest possible wire (min. 2.5 mm²) via the shortest distance and with as little resistance as possible.

3.2.3.4.3 Panel IN

This interface is intended for the SDL connection to a B&R Industrial PC. The necessary SDL cables are available separately from B&R (see "Cables" on page 155).

3.2.3.4.4 Panel OUT

This interface is intended for the SDL connection to an additional Automation Panel 900 device. The necessary SDL cables are available separately from B&R (see "Cables" on page 155).

3.2.4 5DLSD3.1000-00

3.2.4.1 General information

- Link panel for Automation Panel 920/98x
- 1x SDL3 Panel In interface
- 1x USB 2.0 type A

3.2.4.1.1 SDL3 mode

Smart Display Link 3 (SDL3) technology is used to transfer data from all communication channels between a B&R Industrial PC and a panel up to 100 m over a standard Ethernet cable. A male RJ45 connector designed for tight spaces such as feed-throughs and swing arm systems is used to connect to the device.

SDL3 operation with SDL3 transmitter

Operating SDL3 with an SDL3 transmitter in the B&R Industrial PC allows all communication between the Automation Panel and the PC to be transferred using a single SDL3 cable.

This not only includes the display data, but also touch screen, matrix key, LED, service and diagnostic data. The Automation Panel can be installed up to 100 m from the B&R Industrial PC. USB 2.0 is fully integrated in SDL3 and transferred over this distance as well without the need for external modules.

The brightness of the display can be configured using the ADI Control Center.



Availability of interfaces on the Automation Panel with SDL3 receiver:

SDL3 interface ✓ USB1, USB2 ✓ USB 2.0 Power supply ✓ Grounding ✓

SDL3 maximum cable length: 100 m

Prerequisites and requirements

- Automation Panel with SDL3 receiver
- B&R Industrial PC with SDL3 interface
- SDL3 cable

3.2.4.2 Order data

Model number	Short description	Figure
	Display links	
5DLSD3.1000-00	Automation Panel Link SDL3 receiver - For Automation Panel 920/98x	
	Required accessories	
	Terminal blocks	
0TB103.9	Connector 24 VDC - 3-pin female - Screw clamps 3.31 mm ²	
0TB103.91	Connector 24 VDC - 3-pin female - Cage clamps 3.31 mm ²	
	Optional accessories	
	SDL3 cable	
5CASD3.0100-00	SDL3 cable, 10 m	
5CASD3.0150-00	SDL3 cable, 15 m	
5CASD3.0200-00	SDL3 cable, 20 m	
5CASD3.0300-00	SDL3 cable, 30 m	
5CASD3.0500-00	SDL3 cable, 50 m	
5CASD3.1000-00	SDL3 cable, 100 m	

Table 47: 5DLSD3.1000-00 - Order data

3.2.4.3 Technical data

Product ID	5DLSD3.1000-00
General information	
LEDs	Status, Link
B&R ID code	0xE401
Certification cULus	Yes
Interfaces	
USB	
Quantity	1
Type	USB 2.0
Execution	Type A
Transfer rate	Low speed (1.5 Mbit/s), full speed (12 Mbit/s), high speed (max. 30 Mbit/s)
Current load	Max. 500 mA
SDL3 In	
Execution	Shielded female RJ45 connector
Type	SDL3
Electrical characteristics	
Nominal voltage	24 VDC ±25%
Nominal current ¹⁾	Max. 4.2 A
Power consumption	Typ. 6 W
Mechanical characteristics	
Locating screws	
Quantity	2
Max. tightening torque	0.5 Nm

Table 48: 5DLSD3.1000-00 - Technical data

1) The specified value applies to an Automation Panel Link card being used in a 19" Automation Panel system.

3.2.4.4 Interfaces

3.2.4.4.1 SDL3 In interface

The SDL3 In interface is a female RJ45 connector and operated with SDL3 transmission technology. For more information, see "SDL3 mode" on page 105.

SDL3 In interface - SDL3	
The following overview lists the video signals available on the panel input. For additional details, see the technical data for the link module or display unit being used.	
Link module	Video signals
	SDL3

Female RJ45 connector

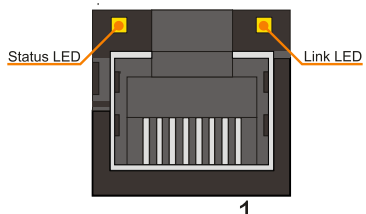

1

Table 49: SDL3 In interface

Information:

The hardware and graphics drivers of approved operating systems support the hot-plugging of display devices to the panel interface for service purposes. The male panel connector is specified for 500 connection cycles.

Information:

If a display device with a touch screen is connected to the panel interface and then disconnected again during operation (hot-plugging), it may be necessary to recalibrate the touch screen.

3.2.4.4.2 SDL3 In LEDs

The SDL3 In LEDs are integrated in the SDL3 In interface and indicate SDL3 activity.

SDL3 In LEDs			
LED	Color	Status	Function
Link	Yellow	On	Indicates an active SDL3 connection.
		Off	No active SDL3 connection.
Status	Yellow	On	The SDL3 connection has been established and is OK.
		Off	No active SDL3 connection.
		Blinking	The SDL3 connection is OK, but a firmware image is corrupt.

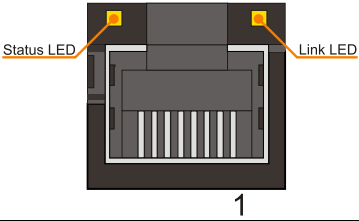

Table 50: SDL3 In LEDs

3.2.4.4.3 USB interface

The link module features a USB 2.0 (Universal Serial Bus) host controller with multiple USB interfaces, 1 of which is accessible externally for the user.

Warning!

Peripheral USB devices can be connected to the USB interfaces on this device. Due to the vast number of USB devices available on the market, B&R cannot guarantee their performance. All USB devices provided by B&R are guaranteed to function properly.

Caution!

Because this interface is designed according to general PC specifications, extreme care should be exercised with regard to EMC, cable routing, etc.

USB

The USB interface is a USB 2.0 type A interface and is available to the user for USB devices.

Universal Serial Bus (USB1) ¹⁾	
Type	USB 2.0
Design	Type A
Transfer rate	Low speed (1.5 Mbit/s), full speed (12 Mbit/s), high speed (max. 30 Mbit/s)
Current load ²⁾ USB	Max. 500 mA
Cable length USB 2.0	Max. 5 m (without hub)



Table 51: USB1 interface

- 1) The interfaces, etc. available on the device or module have been numbered as such for easy identification. This numbering may differ from that used by the particular operating system.
- 2) Each USB interface is protected by a maintenance-free "USB current-limiting circuit breaker" (total max. 500 mA).

3.2.4.4.4 +24 VDC supply voltage

The 3-pin connector required for the supply voltage connection is not included in delivery. It can be ordered from B&R using model number 0TB103.9 (screw clamp) or 0TB103.91 (cage clamp).

The pinout is listed in the following table and printed on the DVI receiver. When dimensioning the power supply, the maximum power consumption of the Automation Panel being used must be taken into consideration (see 2 "Technical data" on page 17).

Supply voltage		3-pin, male 
Protected against reverse polarity		
Pin	Description	
1	+	
2	Functional ground	
3	-	
Required accessories		
Terminal blocks		
0TB103.9	Connector 24 V 5.08 3-pin screw clamp	
0TB103.91	Connector 24 V 5.08 3-pin cage clamp	

Table 52: Supply voltage connection 24 VDC

3.2.4.4.5 Grounding

The supply voltage connection (pin 2) must be connected to the ground using the largest possible wire (min. 2.5 mm²) via the shortest distance and with as little resistance as possible.

3.2.4.5 Known problems/issues

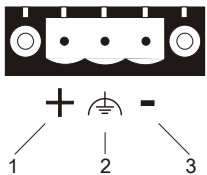
The following display units cannot be used with the SDL3 receiver:

- 5AP920.1043-01
- 5AP951.1043-01
- 5AP952.1043-01
- 5AP980.1043-01 ≤ Rev. E0
- 5AP981.1043-01 ≤ Rev. E0
- 5AP982.1043-01 ≤ Rev. E0
- 5AP920.1214-01 ≤ Rev. D0
- 5AP951.1505-01
- 5AP920.1505-01 ≤ Rev. H0
- 5AP980.1505-01 ≤ Rev. G0
- 5AP981.1505-01 ≤ Rev. I0
- 5AP920.1706-01
- 5AP920.1906-01 ≤ Rev. L0
- 5AP920.2138-01

Chapter 3 • Installation

1 Installation

Danger!

- All supplied power must be disconnected before removing device covers or components or installing/removing accessories, hardware or cables.
- The power cable must be disconnected from the device and from the voltage supply.
- All covers, components, accessories, hardware and cables must be installed or connected before the device can be connected to the power supply and turned on.

B&R Industrial PCs are best mounted in a wall cutout using the retaining clips or clamping blocks found on the housing (designs may vary).

1.1 Important installation information

- Environmental conditions must be taken into consideration.
- When installed in an enclosure, enough space must be available for air to circulate sufficiently.
- This device must be installed on a flat, clean and burr-free surface.
- This device is only certified for operation in enclosed rooms.
- This device must not be subjected to direct sunlight.
- Ventilation holes must not be covered.
- This device must be installed using one of the approved mounting orientations.
- The wall or control cabinet must be able to withstand four times the total weight of the device.
- The flex radius of connected cables (DVI, SDL, USB, etc.) must not be exceeded.
- This device must be installed in a position that minimizes glare on the screen.
- This device must be installed in a position and orientation that make viewing as easy as possible for the operator.

1.2 Installation with clamping blocks

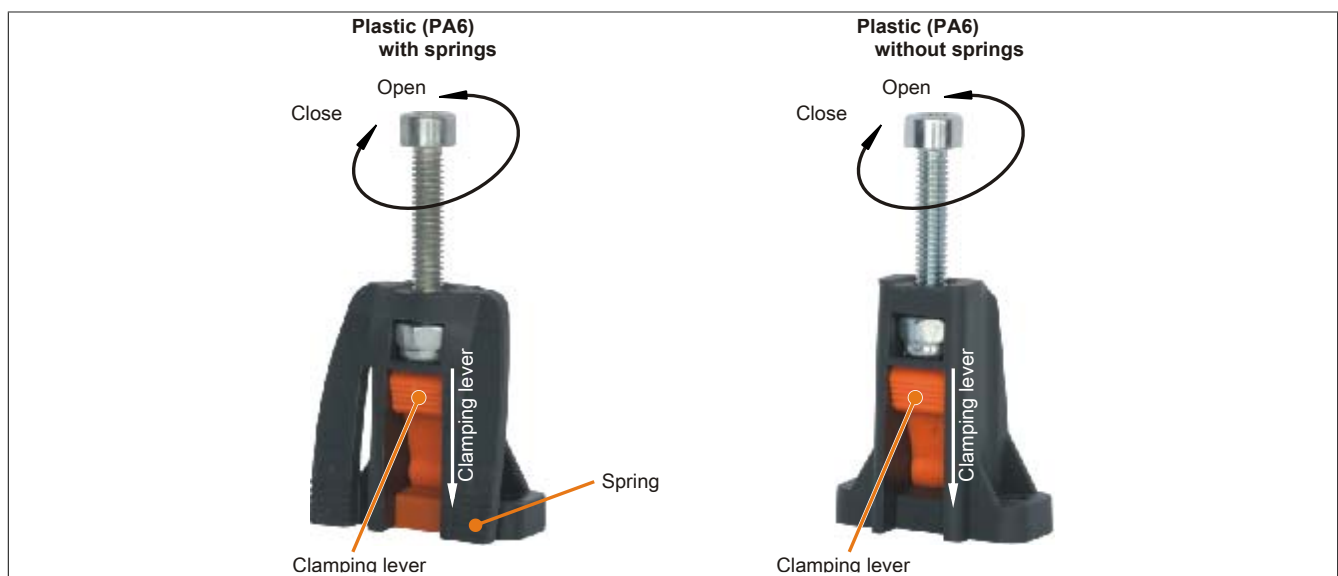

Figure 85: Clamping blocks

Clamping blocks are designed to clamp a maximum thickness of 10 mm and minimum thickness of 2 mm.

A hex key (3 mm) is needed to tighten and loosen the screws. The maximum torque when tightening the clamp is 0.5 Nm.

Devices must be installed on flat, clean and burr-free surface; uneven areas can cause damage to the display when the screws are tightened or intrusion of dust and water.

2 Mounting orientation

The following diagrams show the approved mounting orientations for the Automation Panel 900.

2.1 Mounting orientation 0°

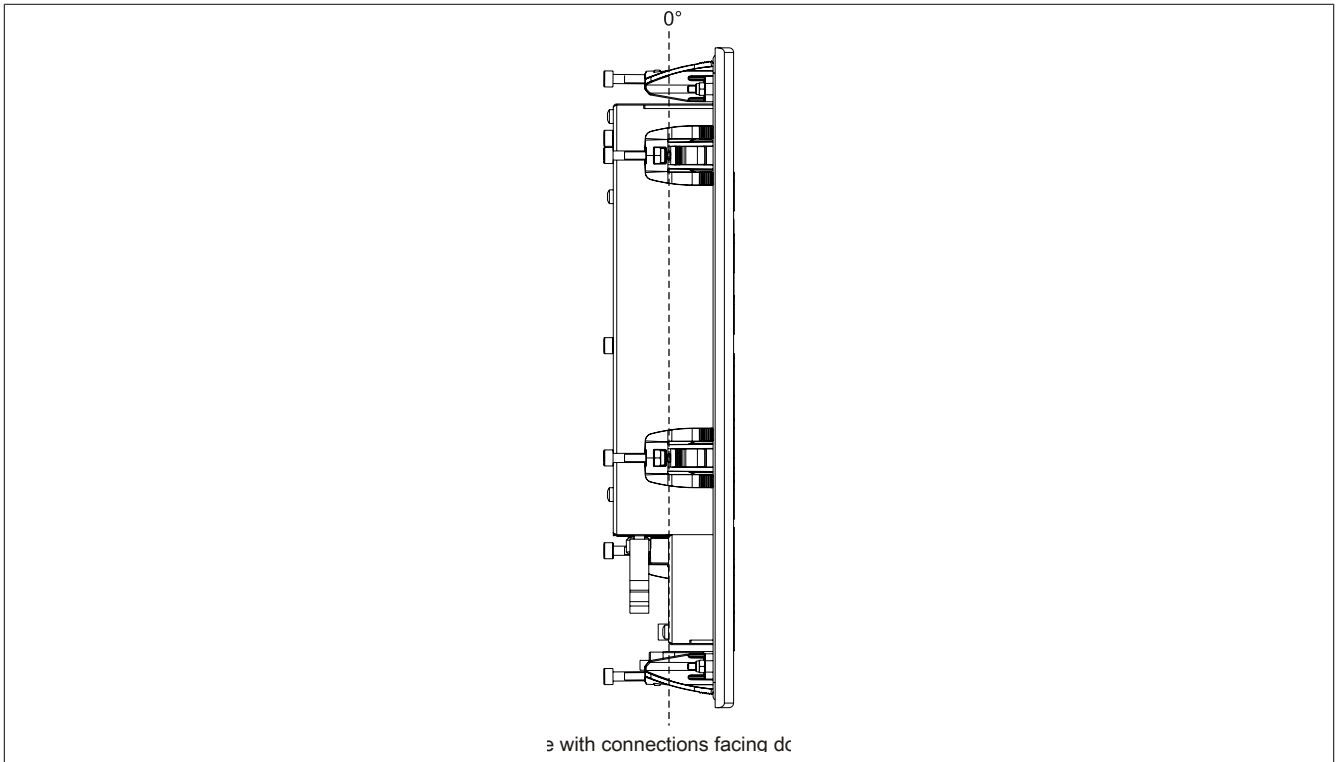

Figure 86: Mounting orientation 0°

2.2 Mounting orientation 45°

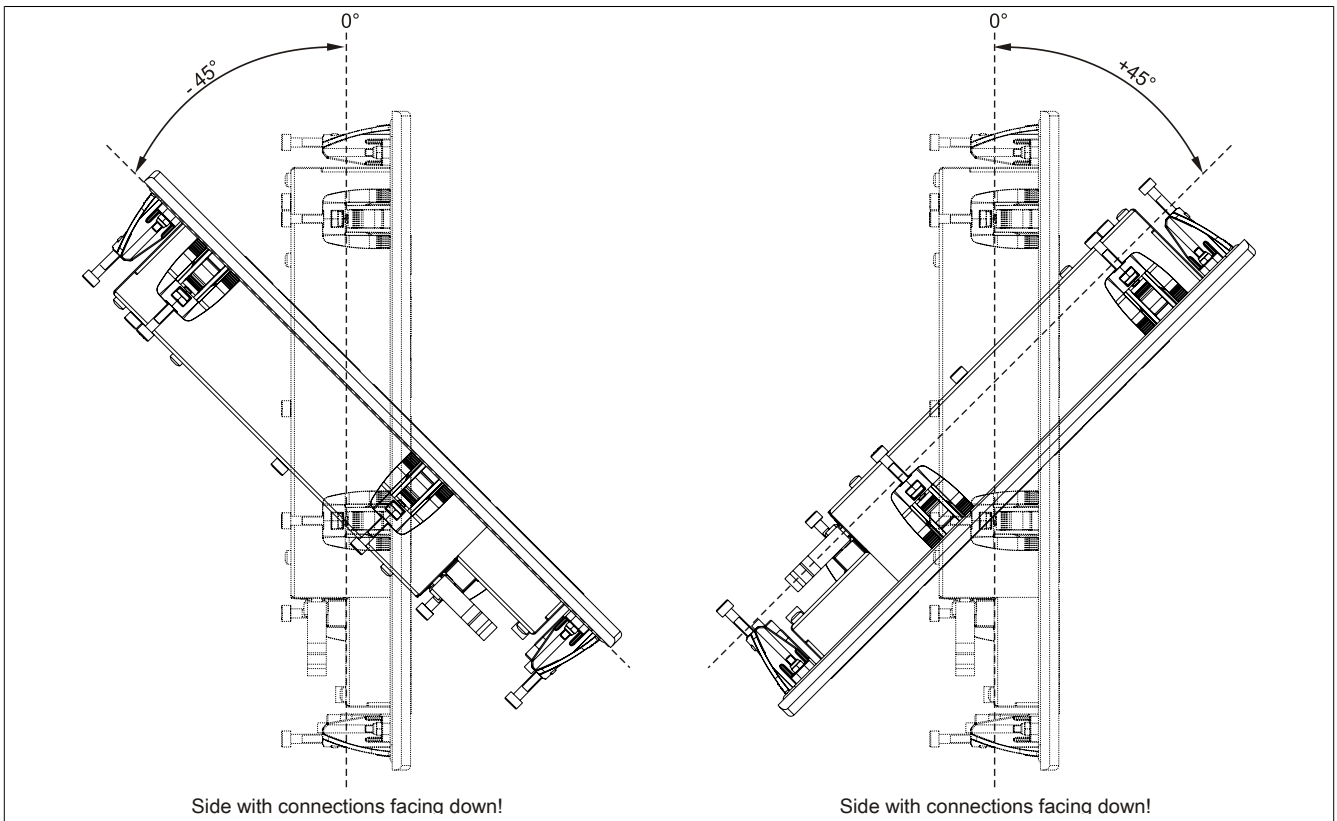

Figure 87: Mounting orientations -45° and +45°.

Warning!

Because of the changed thermal properties with +/- 45° mounting orientations, it is not possible to achieve the specified maximum ambient temperatures during operation for some Automation Panel 900 devices. Applicable limit values can be found in 2 "Technical data" on page 17.

3 Spacing for air circulation

In order to guarantee sufficient air circulation, allow the specified amount of space above, below, to the side and behind the Automation Panel. The minimum specified spacing is indicated in the following diagram.

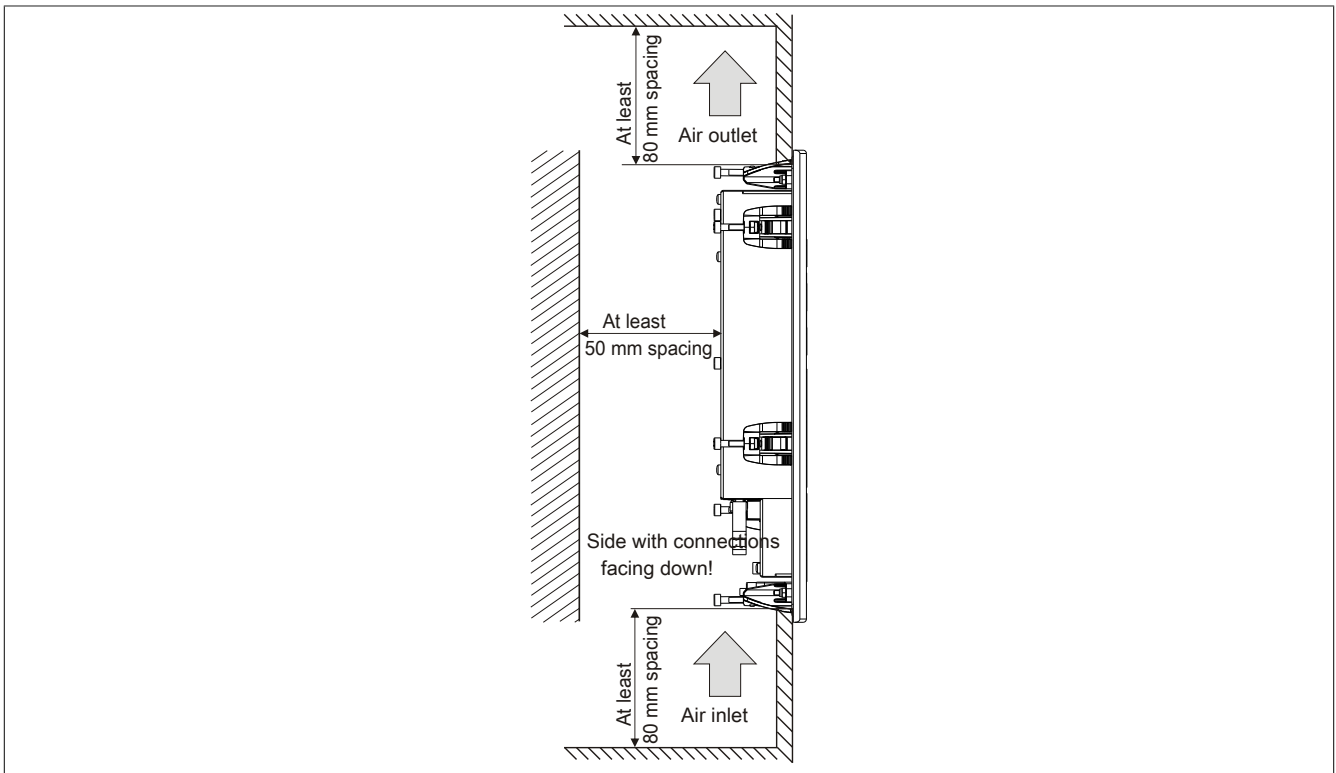

Figure 88: Spacing for air circulation - Side view

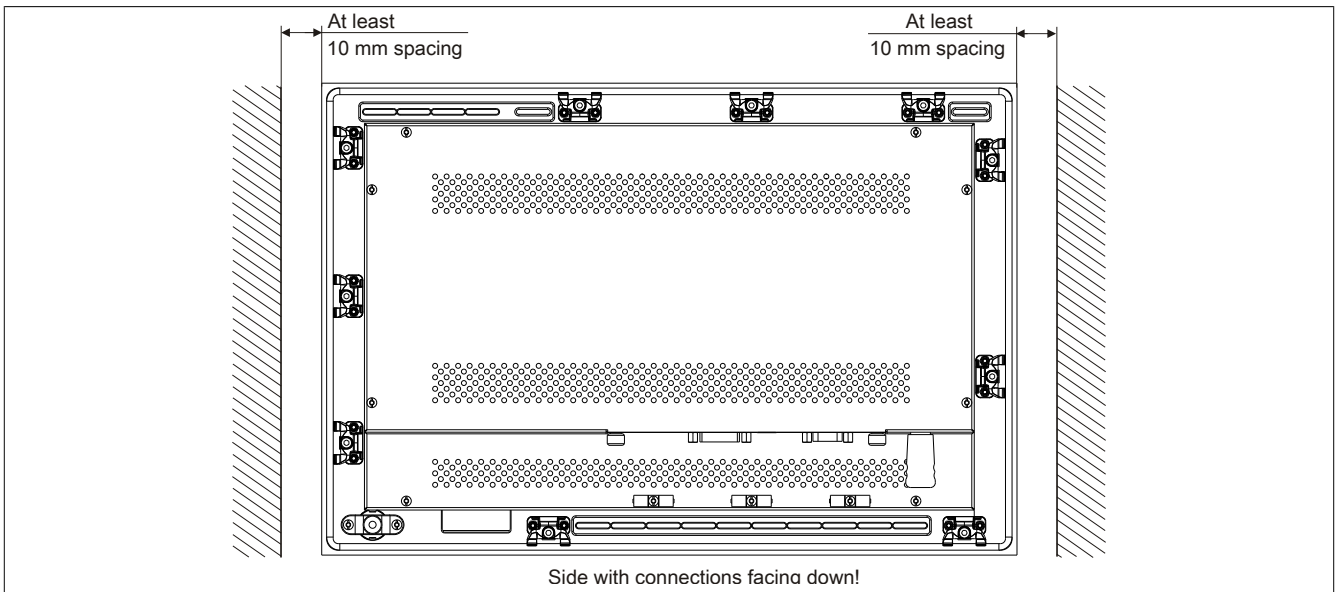

Figure 89: Spacing for air circulation - Rear view

4 Fastening cables

The Automation Panel comes with cable clamps that can be used to fasten connected cables to the back of the Automation Panel (on the bottom).

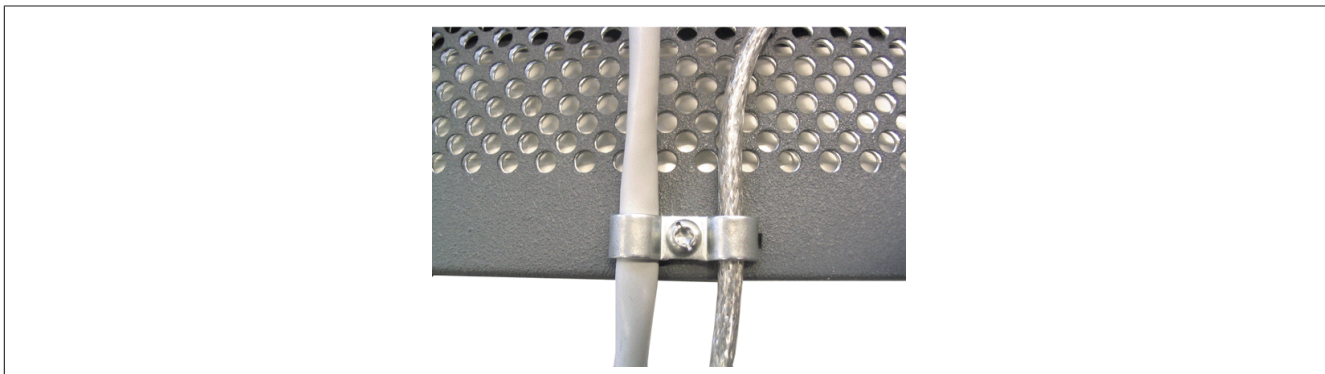

Figure 90: Cable clamps

5 Functional grounding clip

A functional grounding clip is located on the back of the device on the left next to the Automation Panel Link slot. This grounding clip (functional ground) must be connected to a central grounding point on the control cabinet using a 6.3 mm tab connector and the shortest possible line with the least resistance possible (e.g. copper strip, at least 2.5 mm²).



Figure 91: Functional grounding clip

6 General instructions for performing temperature testing

The purpose of these instructions is to explain general procedures for performing application-specific temperature testing on B&R Industrial PCs and Power Panels. Nevertheless, these instructions are meant to serve only as a guideline.

6.1 Procedure

In order to obtain accurate results, the testing conditions should match the conditions in the field. This means that for the duration of the temperature tests, the target application should be running, the PC should be installed in the control cabinet that will be used, etc.

In addition, a temperature sensor should be installed for the device being tested to provide live monitoring of the ambient temperature. In order to obtain accurate measurements, this sensor should be installed at a distance of 5 to 10 cm from the B&R Industrial PC near the air intake (not near the exhaust).

All B&R Industrial PCs and Power Panels are equipped with internal temperature sensors. These are installed in different locations for each series. The number of sensors and the temperature limits also vary from series to series.

For information about the locations of temperature sensors and the maximum specified values, please see section "Temperature sensor locations" in chapter 2 "Technical data".

To ensure that the thermal situation is evaluated reliably, a minimum of 8 hours is recommended for testing.

6.2 Evaluating temperatures in Windows operating systems

6.2.1 Evaluating with the B&R Control Center

The B&R Control Center can be used to evaluate the temperatures. Temperatures can be viewed on the "Temperatures" property page. The B&R Control Center is available at no cost in the Downloads section of the B&R website (www.br-automation.com). The B&R Control Center uses the B&R Automation Device Interface (ADI).

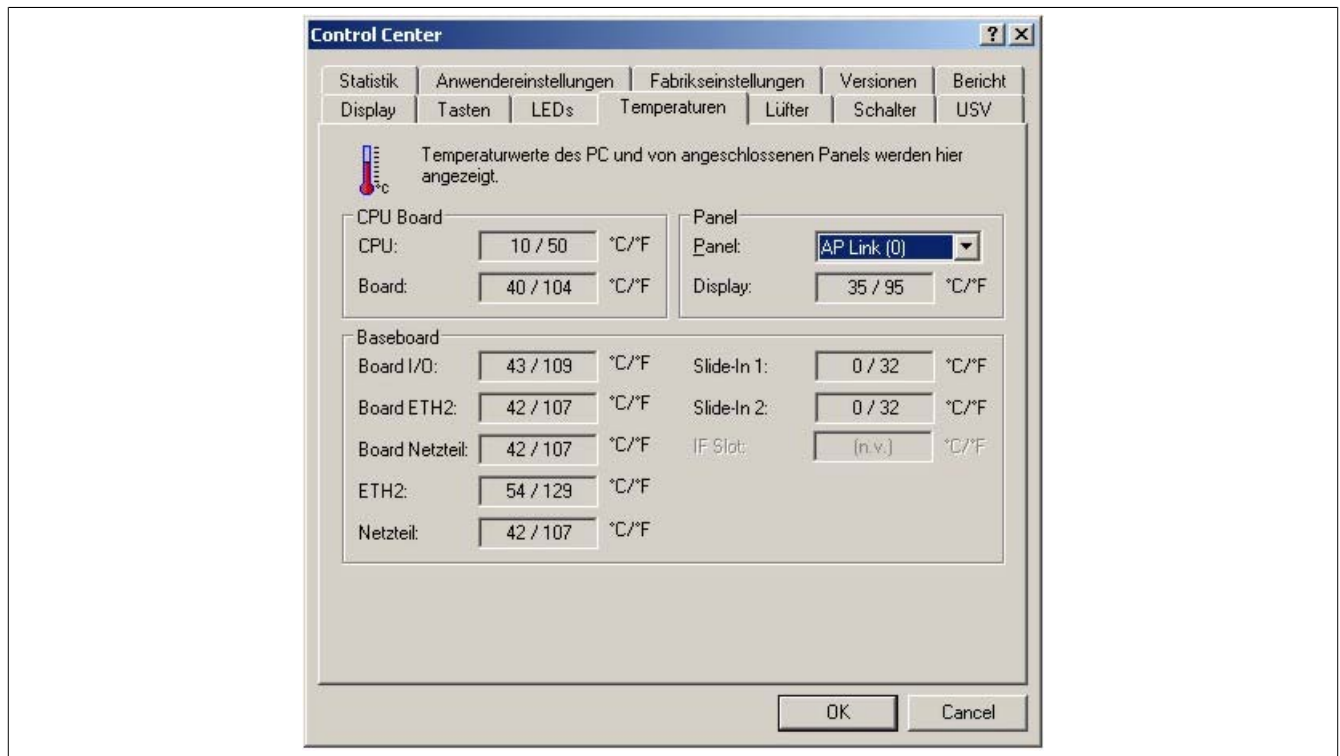

A separate application can be developed if it is necessary to collect historical data.

Information:

Software development kits such as the ADI .NET SDK are available on the B&R website (www.br-automation.com).

6.2.2 Evaluating with the BurnInTest tool from Passmark

If a separate application is not created or used to evaluate the temperature, then B&R recommends using the BurnInTest software tool from Passmark.

Standard and Professional versions of BurnInTest are available. In addition to the software package, there are also various loopback plugs (serial, parallel, USB, etc.) and test CDs/DVDs available. The exact software and loopback plugs used will determine the corresponding load that can be generated on the system and peripheral devices.

Information:

Loopback plugs are also available from Passmark. More information is available at www.passmark.com.

The following screenshots are based on Passmark BurnInTest Pro V4 and a 2-slot APC810 with DVD.

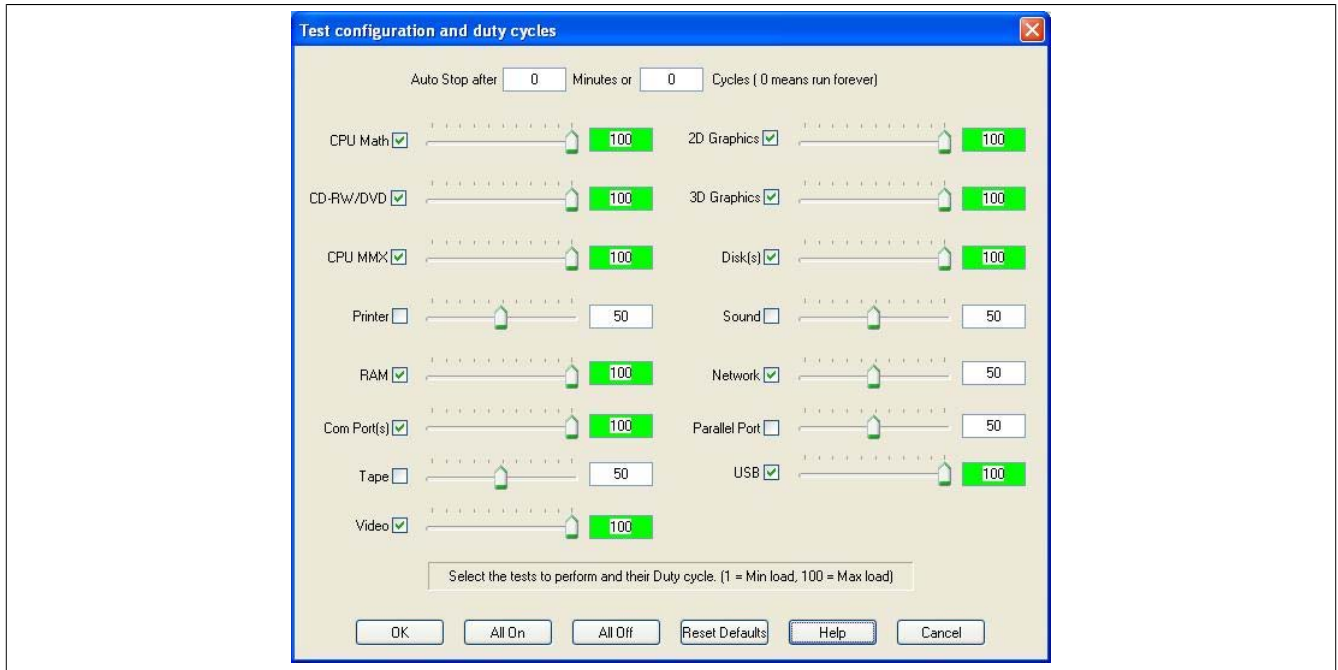

Figure 92: Settings for Passmark BurnInTest Pro V4 and a 2-slot APC810 with DVD

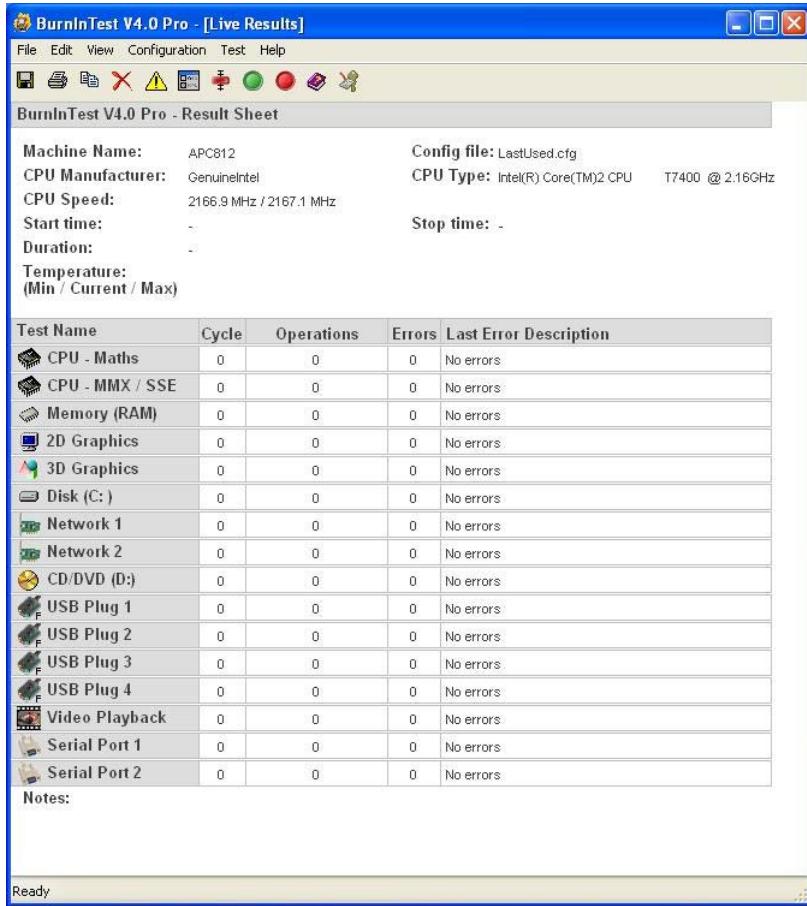

Figure 93: Test overview of a 2-slot APC810 with DVD

The respective test properties may need to be fine-tuned depending on the availability of a loopback plug and DVDs.

Information:

USB flash drives can also be used if a USB loopback plug is not available. The USB flash drives must be detected as formatted drives in Windows. The test USB must then be deselected, and the USB flash drives must be configured as the testing device in the disk properties.



Information:

Serial loopback plugs are relatively easy to create. Simply connect several pins on the serial interface with wires.

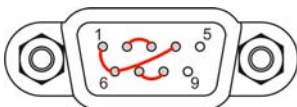

6.3 Evaluating temperatures in operating systems other than Windows

For applications that don't use Windows, temperatures can be evaluated with the help of the B&R implementation guide. In addition to the implementation guide, there are also programs available in MS-DOS.

The implementation guide only describes device-specific functions and not the main functions of the example programs.

If code from the example programs is used, it is important to observe the notes in the implementation guide regarding TODO statements, I/O access functions, etc.

Information:

Example programs and implementation guides for all B&R Industrial PCs and Power Panels are available at no cost from the B&R website (www.br-automation.com).

6.4 Evaluating the measurement results

The maximum temperature value recorded by each sensor must not exceed the temperature limits specified in the user's manuals.

If the temperature tests cannot be performed in a climate-controlled chamber, they can still be performed in an office environment. In this case, however, it is necessary to measure the ambient temperature. Experience at B&R has shown that values measured on passive systems (systems without a fan kit) can be projected linearly based on the ambient temperature. In order to be able to project the temperature values for systems with a fan kit, the fans must be running. It is also important to take values such as speed into consideration.

If the temperature tests are performed in a climate-controlled chamber with fans, the fans will cool the devices and skew the results. Measurement results for passive devices would therefore be unusable in this case. In order to obtain accurate results in climate-controlled chambers with fans, the fans must be turned off and the device must be allowed to run for a sufficient amount of time (several hours) before beginning the test.

Example using a 2-slot APC810

The following example is only valid if the instructions for installation and mounting orientation provided in the user's manual are observed.

Temperature sensor	Measured temperature	Projected temperature	
Ambient temperature	20°C	35°C	45°C
CPU	48°C	63°C	73°C
CPU board	51°C	66°C	76°C
Board I/O	51°C	66°C	76°C
Board ETH2	52°C	67°C	77°C
Board power supply	51°C	66°C	76°C
ETH2	65°C	80°C	90°C
Power supply	51°C	66°C	76°C

Table 53: Evaluation example using a 2-slot APC810

7 Connection examples

An overview of configuration options available for connecting an Automation Panel 900 with a B&R Industrial PC can be found in the user's manual for the PC being used.

Information:

Automation Panel 900 devices can be connected to all B&R devices that support SDL.

Information:

The following examples illustrate how connection examples are portrayed in the respective user's manuals. Device-specific hardware, firmware and software requirements are also listed in the user's manuals for supported devices.

The following device families can be connected to the Automation Panel 900:

- Automation PC 510
- Automation PC 511
- Automation PC 620
- Automation PC 810
- Automation PC 820
- Automation PC 910
- Panel PC 700
- Panel PC 800
- Power Panel 500

7.1 Selecting display units

In order to connect an Automation Panel 800 and an Automation Panel 900 on the same line, the devices must have the same display type. The following table lists the AP900 devices that can be connected on the same line with an AP800 device.

Automation Panel 800	Automation Panel 900
5AP820.1505-00	5AP920.1505-01 5AP951.1505-01 5AP980.1505-01 5AP981.1505-01
5AP880.1505-00	5AP920.1505-01 5AP951.1505-01 5AP980.1505-01 5AP981.1505-01

Table 54: Selecting display units

7.2 One Automation Panel 900 system via onboard DVI

An Automation Panel 900 with max. SXGA resolution is connected to the integrated DVI interface (onboard). As an alternative, an office TFT with a DVI interface or analog monitor (using adapter 5AC900.1000-00) can also be used. A separate cable is used for both the touch screen and USB data. If USB devices are to be operated on the Automation Panel 900, the maximum distance is 5 meters. USB devices can only be connected directly to the Automation Panel (i.e. without a hub).

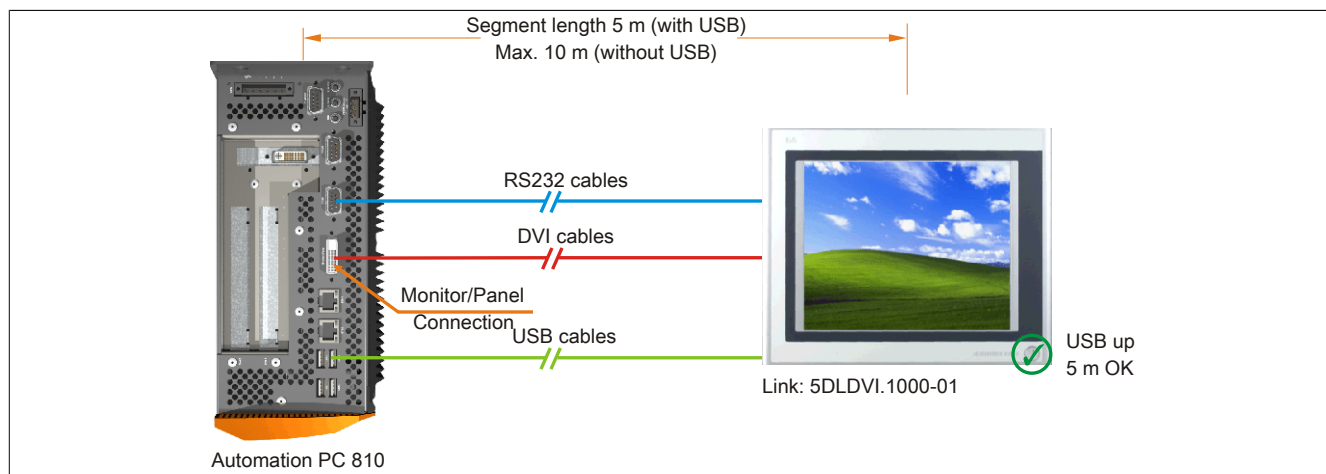

Figure 94: One Automation Panel 900 system via onboard DVI

7.2.1 Base system requirements

Requirements for the base system and information about possible limitations to the maximum resolution can be found in the user's manual for the B&R Industrial PC being used.

7.2.2 Link modules

Information:

A corresponding Link module must be selected for each device used.

Model number	Description	Note
5DL DVI.1000-01	Automation Panel Link DVI receiver Connections for DVI-D, RS232 and USB 2.0 (Type B); 24 VDC (order screw clamp 0TB103.9 or cage clamp 0TB103.91 separately)	For Automation Panel 900

Table 55: Link modules

7.2.3 Cables

Select one Automation Panel 900 cable each from the 3 required types.

Model number	Description	Length
5CADVI.0018-00	DVI-D cable, 1.8 m	1.8 m ±50 mm
5CADVI.0050-00	DVI-D cable, 5 m	5 m ±80 mm
5CADVI.0100-00	DVI-D cable, 10 m	10 m ±100 mm
9A0014.02	RS232 extension cable for remote operation of a display unit with touch screen, 1.8 m	1.8 m ±50 mm
9A0014.05	RS232 extension cable for remote operation of a display unit with touch screen, 5 m	5 m ±80 mm
9A0014.10	RS232 extension cable for remote operation of a display unit with touch screen, 10 m	10 m ±100 mm
5CAUSB.0018-00	USB 2.0 connection cable Type A - Type B, 1.8 m	1.8 m ±30 mm
5CAUSB.0050-00	USB 2.0 connection cable Type A - Type B, 5 m	5 m ±50 mm

Table 56: Cables for DVI configurations

Information:

Detailed technical data about cables is listed in the section "Cables" on page 155.

7.2.4 Possible Automation Panel devices, resolutions and segment lengths

The following Automation Panel 900 devices can be used. In rare cases, segment length is limited by the resolution.

Model number	Display size	Resolution	Touch screen	Keys	Max. segment length
5AP920.1043-01	10.4"	VGA	✓	-	5 m / 10 m ¹⁾
5AP920.1214-01	12.1"	SVGA	✓	-	5 m / 10 m ¹⁾
5AP920.1505-01	15.0"	XGA	✓	-	5 m / 10 m ¹⁾
5AP920.1706-01	17.0"	SXGA	✓	-	5 m / 10 m ¹⁾
5AP920.1906-01	19.0"	SXGA	✓	-	5 m / 10 m ¹⁾

Table 57: Possible Automation Panel devices, resolutions and segment lengths

- 1) USB support is not possible on the Automation Panel 900 in these cases since USB is limited to 5 m.

Information:

When transferring data via DVI, it is not possible to read statistical values from Automation Panel 900 devices.

7.2.5 BIOS settings

No special BIOS settings are necessary for operation.

7.3 One Automation Panel 900 system via onboard SDL

An Automation Panel 900 is connected to the integrated SDL interface (onboard) via an SDL cable. USB devices can only be connected directly to the Automation Panel (i.e. without a hub).

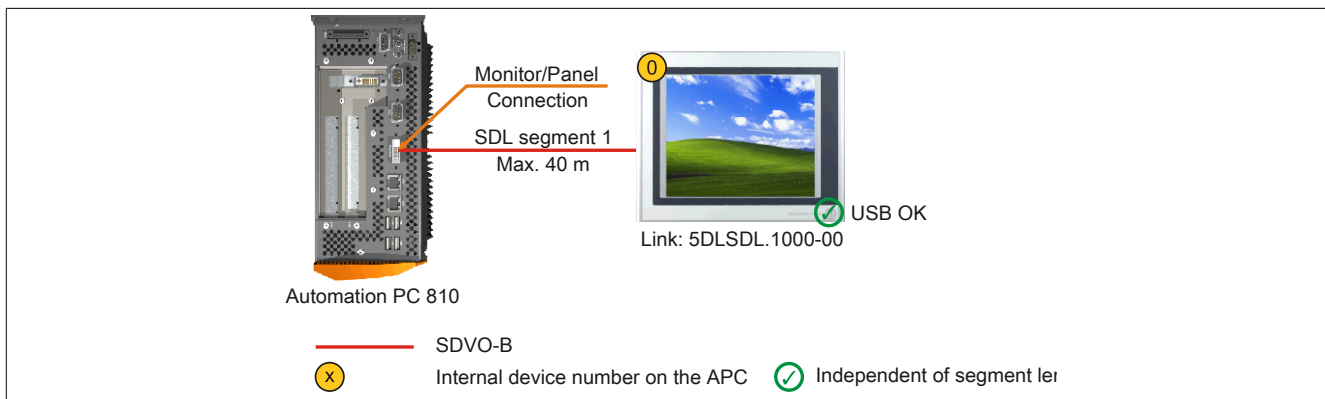

Figure 95: One Automation Panel 900 system via onboard SDL

7.3.1 Base system requirements

Requirements for the base system and information about possible limitations to the maximum resolution can be found in the user's manual for the B&R Industrial PC being used.

7.3.2 Link modules

Information:

A corresponding Link module must be selected for each device used.

Model number	Description	Note
5DLSDL.1000-00	Automation Panel Link SDL receiver Connection for SDL In; transmission of display, touch screen, USB 1.1, matrix key and service data; 24 VDC (order screw clamp 0TB103.9 or cage clamp 0TB103.91 separately)	For Automation Panel 900

Table 58: Link modules

7.3.3 Cables

Select an Automation Panel 900 cable from the following table.

Model number	Description	Length
5CASDL.0018-00	SDL cable, 1.8 m	1.8 m ±30 mm
5CASDL.0050-00	SDL cable, 5 m	5 m ±30 mm
5CASDL.0100-00	SDL cable, 10 m	10 m ±50 mm
5CASDL.0150-00	SDL cable, 15 m	15 m ±100 mm
5CASDL.0200-00	SDL cable, 20 m	20 m ±100 mm
5CASDL.0250-00	SDL cable, 25 m	25 m ±100 mm
5CASDL.0300-00	SDL cable, 30 m	30 m ±100 mm
5CASDL.0018-03	SDL flex cable, 1.8 m	1.8 m ±20 mm
5CASDL.0050-03	SDL flex cable, 5 m	5 m ±45 mm
5CASDL.0100-03	SDL flex cable, 10 m	10 m ±90 mm
5CASDL.0150-03	SDL flex cable, 15 m	15 m ±135 mm
5CASDL.0200-03	SDL flex cable, 20 m	20 m ±180 mm
5CASDL.0250-03	SDL flex cable, 25 m	25 m ±225 mm
5CASDL.0300-03	SDL flex cable, 30 m	30 m ±270 mm
5CASDL.0300-13	SDL flex cable with extender, 30 m	30 m ±280 mm
5CASDL.0400-13	SDL flex cable with extender, 40 m	40 m ±380 mm
5CASDL.0430-13	SDL flex cable with extender, 43 m	43 m ±410 mm
5CASDL.0018-01	SDL cable with 45° connector, 1.8 m	1.8 m ±30 mm
5CASDL.0050-01	SDL cable with 45° connector, 5 m	5 m ±50 mm
5CASDL.0100-01	SDL cable with 45° connector, 10 m	10 m ±100 mm
5CASDL.0150-01	SDL cable with 45° connector, 15 m	15 m ±100 mm

Table 59: Cables for SDL configurations

Information:

Detailed technical data about cables is listed in the section "Cables" on page 155.

7.3.3.1 Cable lengths and resolutions for SDL transmission

The following table lists the relationship between segment lengths and maximum resolution depending on the SDL cable being used:

SDL cable Segment length [m]	Resolution						
	VGA 640 x 480	SVGA 800 x 600	XGA 1024 x 768	HD 1366 x 768	SXGA 1280 x 1024	UXGA 1600 x 1200	FHD 1920 x 1080
1.8	5CASDL.0018-00	5CASDL.0018-00	5CASDL.0018-00	5CASDL.0018-00	5CASDL.0018-00	5CASDL.0018-00	5CASDL.0018-00
	5CASDL.0018-01	5CASDL.0018-01	5CASDL.0018-01	5CASDL.0018-01	5CASDL.0018-01	5CASDL.0018-01	5CASDL.0018-01
	5CASDL.0018-03	5CASDL.0018-03	5CASDL.0018-03	5CASDL.0018-03	5CASDL.0018-03	5CASDL.0018-03	5CASDL.0018-03
5	5CASDL.0050-00	5CASDL.0050-00	5CASDL.0050-00	5CASDL.0050-00	5CASDL.0050-00	5CASDL.0050-00	5CASDL.0050-00
	5CASDL.0050-01	5CASDL.0050-01	5CASDL.0050-01	5CASDL.0050-01	5CASDL.0050-01	5CASDL.0050-01	5CASDL.0050-01
	5CASDL.0050-03	5CASDL.0050-03	5CASDL.0050-03	5CASDL.0050-03	5CASDL.0050-03	5CASDL.0050-03	5CASDL.0050-03
10	5CASDL.0100-00	5CASDL.0100-00	5CASDL.0100-00	5CASDL.0100-00	5CASDL.0100-00	5CASDL.0100-00	5CASDL.0100-00
	5CASDL.0100-01	5CASDL.0100-01	5CASDL.0100-01	5CASDL.0100-01	5CASDL.0100-01	5CASDL.0100-01	5CASDL.0100-01
	5CASDL.0100-03	5CASDL.0100-03	5CASDL.0100-03	5CASDL.0100-03	5CASDL.0100-03	5CASDL.0100-03	5CASDL.0100-03
15	5CASDL.0150-00	5CASDL.0150-00	5CASDL.0150-00	5CASDL.0150-00	5CASDL.0150-00	-	-
	5CASDL.0150-01	5CASDL.0150-01	5CASDL.0150-01	5CASDL.0150-01	5CASDL.0150-01	-	-
	5CASDL.0150-03	5CASDL.0150-03	5CASDL.0150-03	5CASDL.0150-03	5CASDL.0150-03	-	5CASDL.0150-03
20	5CASDL.0200-00	5CASDL.0200-00	5CASDL.0200-00	5CASDL.0200-00	5CASDL.0200-00	-	-
	5CASDL.0200-03	5CASDL.0200-03	5CASDL.0200-03	5CASDL.0200-03	5CASDL.0200-03	-	5CASDL.0200-03
25	5CASDL.0250-00	5CASDL.0250-00	5CASDL.0250-00	5CASDL.0250-00	-	-	-
	5CASDL.0250-03	5CASDL.0250-03	5CASDL.0250-03	5CASDL.0250-03	-	-	-
30	5CASDL.0300-00	5CASDL.0300-00	-	-	-	-	-
	5CASDL.0300-03	5CASDL.0300-03	5CASDL.0300-13	5CASDL.0300-13	5CASDL.0300-13	-	5CASDL.0300-13
40	5CASDL.0400-13	5CASDL.0400-13	5CASDL.0400-13	5CASDL.0400-13	5CASDL.0400-13	-	5CASDL.0400-13

Table 60: Cable lengths and resolutions for SDL transmission

7.3.4 Settings in BIOS

No special BIOS settings are necessary for operation.

For detailed information, see the user's manual for the B&R Industrial PC being used.

Touch screen functionality

COM C must be enabled in BIOS in order to operate the panel touch screen connected to the monitor/panel interface ("Advanced - Baseboard/Panel features - Legacy devices").

7.4 Four Automation Panel 900 systems via onboard SDL

An Automation Panel 900 is connected to the integrated SDL interface (onboard) via an SDL cable. Up to three other Automation Panels of the same type are connected to this Automation Panel and operated via SDL. All four of the panels show the same content (display clone).

USB is supported up to a maximum distance (SDL segment 1 + SDL segment 2) of 30 m on the first two panels (front and back). Past a distance of 30 m, USB is only available for the first panel (front and back). USB devices can only be connected directly to the Automation Panel (i.e. without a hub).

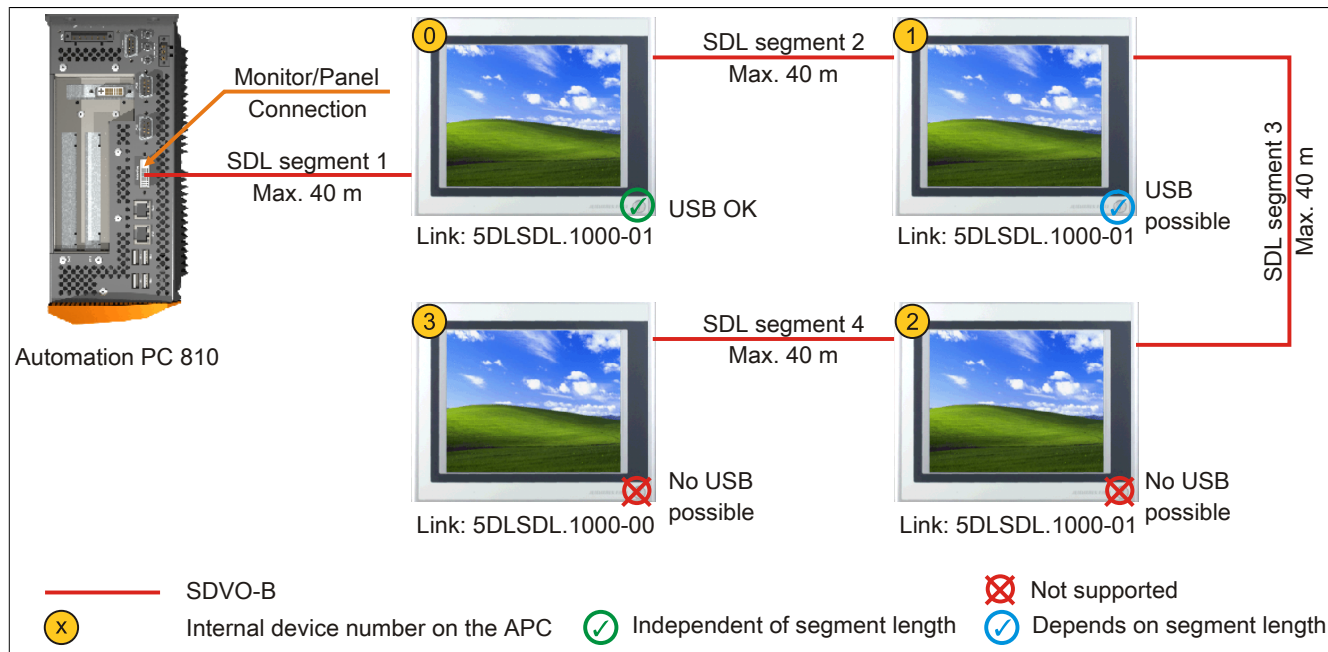

Figure 96: Four Automation Panel 900 systems via onboard SDL

7.4.1 Base system requirements

Requirements for the base system and information about possible limitations to the maximum resolution can be found in the user's manual for the B&R Industrial PC being used.

7.4.2 Link modules

Information:

A corresponding Link module must be selected for each device used.

Model number	Description	Note
5DLSDL.1000-00	Automation Panel Link SDL receiver Connection for SDL In; transmission of display, touch screen, USB 1.1, matrix key and service data; 24 VDC (order screw clamp 0TB103.9 or cage clamp 0TB103.91 separately)	For Automation Panel 900
5DLSDL.1000-01	Automation Panel Link SDL transceiver Connections for SDL In and SDL Out; transmission of display, touch screen, USB 1.1, matrix key and service data; 24 VDC (order screw clamp 0TB103.9 or cage clamp 0TB103.91 separately)	For Automation Panel 900

Table 61: Link modules

7.4.3 Cables

Select an Automation Panel 900 cable from the following table.

Model number	Description	Length
5CASDL.0018-00	SDL cable, 1.8 m	1.8 m ±30 mm
5CASDL.0050-00	SDL cable, 5 m	5 m ±30 mm
5CASDL.0100-00	SDL cable, 10 m	10 m ±50 mm
5CASDL.0150-00	SDL cable, 15 m	15 m ±100 mm
5CASDL.0200-00	SDL cable, 20 m	20 m ±100 mm
5CASDL.0250-00	SDL cable, 25 m	25 m ±100 mm
5CASDL.0300-00	SDL cable, 30 m	30 m ±100 mm
5CASDL.0018-03	SDL flex cable, 1.8 m	1.8 m ±20 mm

Table 62: Cables for SDL configurations

Model number	Description	Length
5CASDL.0050-03	SDL flex cable, 5 m	5 m ±45 mm
5CASDL.0100-03	SDL flex cable, 10 m	10 m ±90 mm
5CASDL.0150-03	SDL flex cable, 15 m	15 m ±135 mm
5CASDL.0200-03	SDL flex cable, 20 m	20 m ±180 mm
5CASDL.0250-03	SDL flex cable, 25 m	25 m ±225 mm
5CASDL.0300-03	SDL flex cable, 30 m	30 m ±270 mm
5CASDL.0300-13	SDL flex cable with extender, 30 m	30 m ±280 mm
5CASDL.0400-13	SDL flex cable with extender, 40 m	40 m ±380 mm
5CASDL.0430-13	SDL flex cable with extender, 43 m	43 m ±410 mm
5CASDL.0018-01	SDL cable with 45° connector, 1.8 m	1.8 m ±30 mm
5CASDL.0050-01	SDL cable with 45° connector, 5 m	5 m ±50 mm
5CASDL.0100-01	SDL cable with 45° connector, 10 m	10 m ±100 mm
5CASDL.0150-01	SDL cable with 45° connector, 15 m	15 m ±100 mm

Table 62: Cables for SDL configurations

Information:

Detailed technical data about cables is listed in the section "Cables" on page 155.

7.4.3.1 Cable lengths and resolutions for SDL transmission

The following table lists the relationship between segment lengths and maximum resolution depending on the SDL cable being used:

SDL cable Segment length [m]	Resolution						
	VGA 640 x 480	SVGA 800 x 600	XGA 1024 x 768	HD 1366 x 768	SXGA 1280 x 1024	UXGA 1600 x 1200	FHD 1920 x 1080
1.8	5CASDL.0018-00	5CASDL.0018-00	5CASDL.0018-00	5CASDL.0018-00	5CASDL.0018-00	5CASDL.0018-00	5CASDL.0018-00
	5CASDL.0018-01	5CASDL.0018-01	5CASDL.0018-01	5CASDL.0018-01	5CASDL.0018-01	5CASDL.0018-01	5CASDL.0018-01
	5CASDL.0018-03	5CASDL.0018-03	5CASDL.0018-03	5CASDL.0018-03	5CASDL.0018-03	5CASDL.0018-03	5CASDL.0018-03
5	5CASDL.0050-00	5CASDL.0050-00	5CASDL.0050-00	5CASDL.0050-00	5CASDL.0050-00	5CASDL.0050-00	5CASDL.0050-00
	5CASDL.0050-01	5CASDL.0050-01	5CASDL.0050-01	5CASDL.0050-01	5CASDL.0050-01	5CASDL.0050-01	5CASDL.0050-01
	5CASDL.0050-03	5CASDL.0050-03	5CASDL.0050-03	5CASDL.0050-03	5CASDL.0050-03	5CASDL.0050-03	5CASDL.0050-03
10	5CASDL.0100-00	5CASDL.0100-00	5CASDL.0100-00	5CASDL.0100-00	5CASDL.0100-00	5CASDL.0100-00	5CASDL.0100-00
	5CASDL.0100-01	5CASDL.0100-01	5CASDL.0100-01	5CASDL.0100-01	5CASDL.0100-01	5CASDL.0100-01	5CASDL.0100-01
	5CASDL.0100-03	5CASDL.0100-03	5CASDL.0100-03	5CASDL.0100-03	5CASDL.0100-03	5CASDL.0100-03	5CASDL.0100-03
15	5CASDL.0150-00	5CASDL.0150-00	5CASDL.0150-00	5CASDL.0150-00	5CASDL.0150-00	-	-
	5CASDL.0150-01	5CASDL.0150-01	5CASDL.0150-01	5CASDL.0150-01	5CASDL.0150-01	-	-
	5CASDL.0150-03	5CASDL.0150-03	5CASDL.0150-03	5CASDL.0150-03	5CASDL.0150-03	-	5CASDL.0150-03
20	5CASDL.0200-00	5CASDL.0200-00	5CASDL.0200-00	5CASDL.0200-00	5CASDL.0200-00	-	-
	5CASDL.0200-03	5CASDL.0200-03	5CASDL.0200-03	5CASDL.0200-03	5CASDL.0200-03	-	5CASDL.0200-03
25	5CASDL.0250-00	5CASDL.0250-00	5CASDL.0250-00	5CASDL.0250-00	-	-	-
	5CASDL.0250-03	5CASDL.0250-03	5CASDL.0250-03	5CASDL.0250-03	-	-	-
30	5CASDL.0300-00	5CASDL.0300-00	-	-	-	-	-
	5CASDL.0300-03	5CASDL.0300-03	5CASDL.0300-13	5CASDL.0300-13	5CASDL.0300-13	-	5CASDL.0300-13
40	5CASDL.0400-13	5CASDL.0400-13	5CASDL.0400-13	5CASDL.0400-13	5CASDL.0400-13	-	5CASDL.0400-13

Table 63: Cable lengths and resolutions for SDL transmission

7.4.4 Settings in BIOS

No special BIOS settings are necessary for operation.

For detailed information, see the user's manual for the B&R Industrial PC being used.

Touch screen functionality

COM C must be enabled in BIOS in order to operate the panel touch screen connected to the monitor/panel interface ("Advanced - Baseboard/Panel features - Legacy devices").

7.5 One Automation Panel 900 via SDL3

One Automation Panel 900 is connected to the optional SDL3 interface via an SDL3 cable. USB devices can only be connected directly to the Automation Panel (i.e. without a hub).

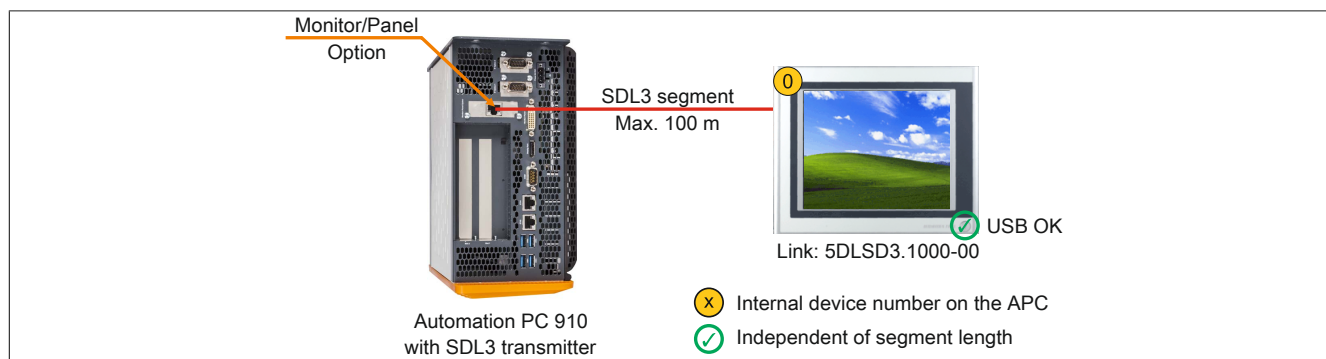

Figure 97: One Automation Panel 900 via SDL3 (sample photo)

7.5.1 Base system requirements

Requirements for the base system and information about possible limitations to the maximum resolution can be found in the user's manual for the B&R Industrial PC being used.

7.5.2 Link modules

Information:

A corresponding Link module must be selected for each device used.

Model number	Description	Note
5DLS3.1000-00	Automation Panel Link SDL3 receiver	for Automation Panel 900

Table 64: Link modules

7.5.3 Cables

Select an Automation Panel 900 cable from the following table.

Model number	Description	Length
5CASD3.0100-00	SDL3 cable, 10 m	10 m
5CASD3.0150-00	SDL3 cable, 15 m	15 m
5CASD3.0200-00	SDL3 cable, 20 m	20 m
5CASD3.0300-00	SDL3 cable, 30 m	30 m
5CASD3.0500-00	SDL3 cable, 50 m	50 m
5CASD3.1000-00	SDL3 cable, 100 m	100 m

Table 65: Cables for SDL3 configurations

Information:

Detailed technical data about cables is listed in the section "Cables" on page 155.

7.5.3.1 Cable lengths and resolutions for SDL3 transmission

The following table lists the relationship between segment lengths and maximum resolution depending on the SDL3 cable being used:

SDL3 cable Segment length [m]	Resolution						
	VGA 640 x 480	SVGA 800 x 600	XGA 1024 x 768	HD 1366 x 768	SXGA 1280 x 1024	UXGA 1600 x 1200	FHD 1920 x 1080
10	5CASD3.0100-00	5CASD3.0100-00	5CASD3.0100-00	5CASD3.0100-00	5CASD3.0100-00	5CASD3.0100-00	5CASD3.0100-00
15	5CASD3.0150-00	5CASD3.0150-00	5CASD3.0150-00	5CASD3.0150-00	5CASD3.0150-00	5CASD3.0150-00	5CASD3.0150-00
20	5CASD3.0200-00	5CASD3.0200-00	5CASD3.0200-00	5CASD3.0200-00	5CASD3.0200-00	5CASD3.0200-00	5CASD3.0200-00
30	5CASD3.0300-00	5CASD3.0300-00	5CASD3.0300-00	5CASD3.0300-00	5CASD3.0300-00	5CASD3.0300-00	5CASD3.0300-00
50	5CASD3.0500-00	5CASD3.0500-00	5CASD3.0500-00	5CASD3.0500-00	5CASD3.0500-00	5CASD3.0500-00	5CASD3.0500-00
100	5CASD3.1000-00	5CASD3.1000-00	5CASD3.1000-00	5CASD3.1000-00	5CASD3.1000-00	5CASD3.1000-00	5CASD3.1000-00

Table 66: Cable lengths and resolutions for SDL3 transmission

7.5.4 Settings in BIOS

No special BIOS settings are necessary for operation.

For detailed information, see the user's manual for the B&R Industrial PC being used.

Touch screen functionality

COM C must be enabled in BIOS in order to operate the panel touch screen connected to the monitor/panel interface ("Advanced - Baseboard/Panel features - Legacy devices").

8 Connecting peripheral USB devices

Warning!

Peripheral USB devices can be connected to the USB interfaces on this device. Due to the vast number of USB devices available on the market, B&R cannot guarantee their performance. USB devices from B&R are guaranteed to function properly, however.

8.1 Remote connection to Automation Panel 900 via DVI

Many different peripheral USB devices can be connected to the 2 or 3 USB interfaces on the Automation Panel 900. These can each handle a load of 500 mA. The maximum transfer rate is USB 2.0.

Information:

Only end devices (not hubs) can be connected to the Automation Panel 900.



Figure 98: Remote connection of USB peripheral devices on the APC900 via DVI

8.2 Remote connection to Automation Panel 800 / 900 via SDL

Many different peripheral USB devices can be connected to the 2 or 3 USB interfaces on Automation Panel 900 or the USB interfaces on Automation Panel 800 devices. These can each handle a load of 500 mA. The maximum transfer rate is USB 1.1.

Information:

Only end devices (no hubs) can be connected to the Automation Panel 800 / 900.



Figure 99: Remote connection of USB peripheral devices on the APC800/900 via SDL

8.3 Remote connection to Automation Panel 900 via SDL3

Many different peripheral USB devices can be connected to the 2 or 3 USB interfaces on the Automation Panel 900. These can each handle a load of 500 mA. The maximum transfer rate is USB 2.0.

Information:

Only end devices (not hubs) can be connected to the Automation Panel 900.



Figure 100: Remote connection of USB peripheral devices to the 900 via SDL3

9 Key and LED configurations

Each key or LED can be configured individually and adapted directly to the application. Various B&R tools are available for this purpose:

- B&R Key Editor for Windows operating systems
- Visual Components for Automation Runtime

Keys and LEDs from each device are processed by the matrix controller in a bit sequence of 128 bits each.

The positions of keys and LEDs in the matrix are shown as hardware numbers. These hardware numbers can be read directly from the target system using the B&R Key Editor or the B&R Control Center.

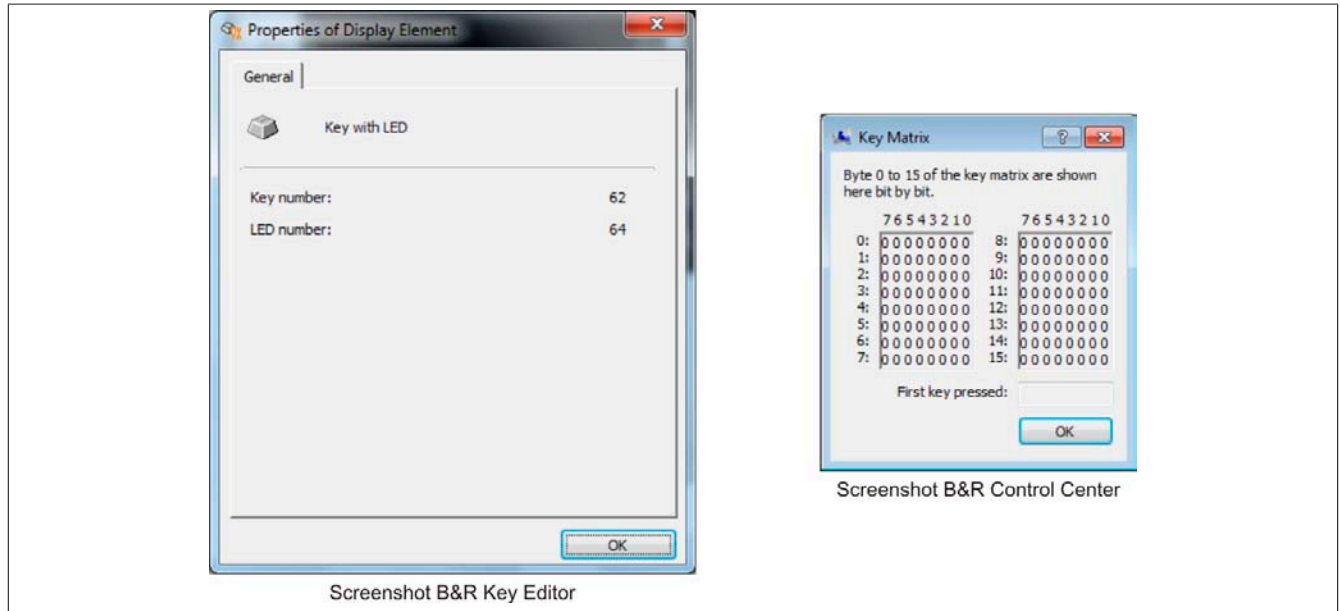

Figure 101: Hardware numbers in the B&R Key Editor and B&R Control Center

The images below show the positions of keys and LEDs in the matrix. This information is indicated as follows.

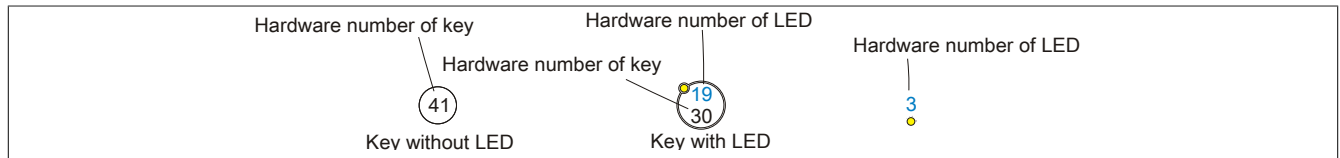

Figure 102: Keys and LEDs in the matrix

9.1 Automation Panel 10.4" VGA

9.1.1 Automation Panel 5AP951.1043-01 / 5AP981.1043-01

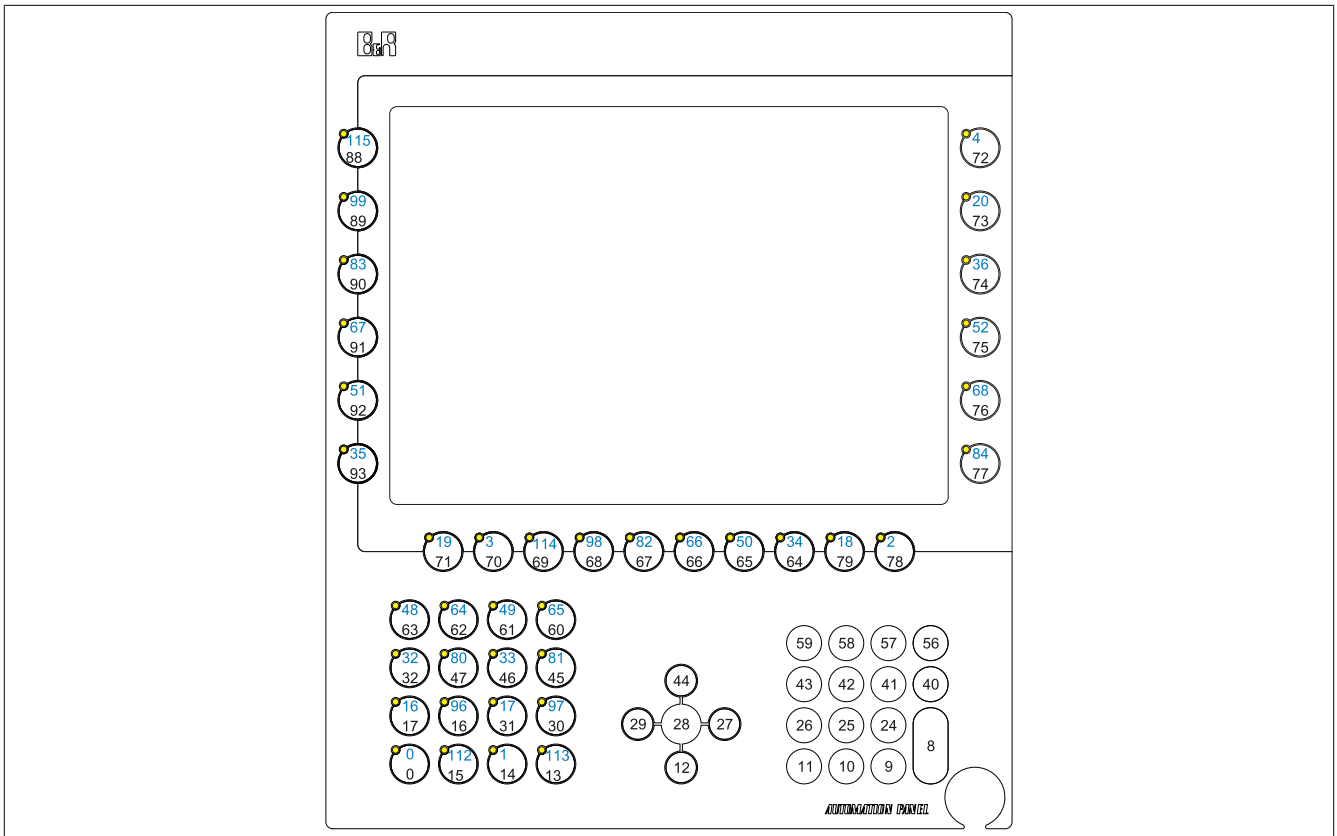

Figure 103: 5AP951.1043-01 / 5AP981.1043-01 - Hardware numbers

9.1.2 Automation Panel 5AP952.1043-01 / 5AP982.1043-01

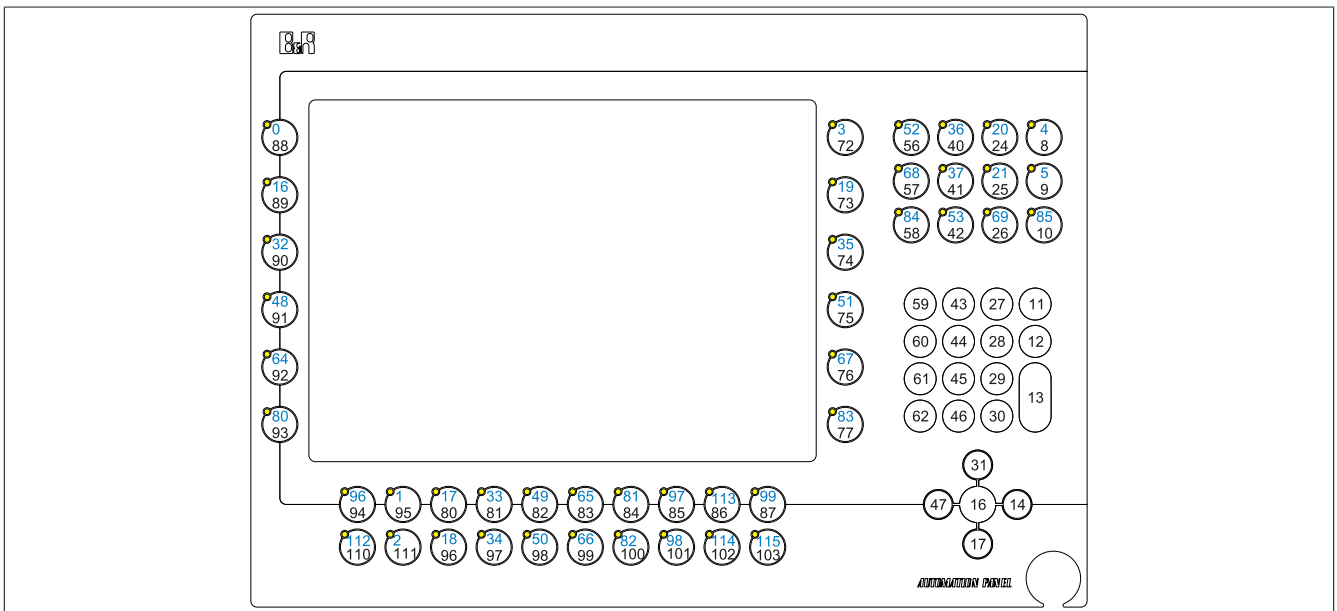

Figure 104: 5AP952.1043-01 / 5AP982.1043-01 - Hardware numbers

9.1.3 Automation Panel 5AP980.1043-01

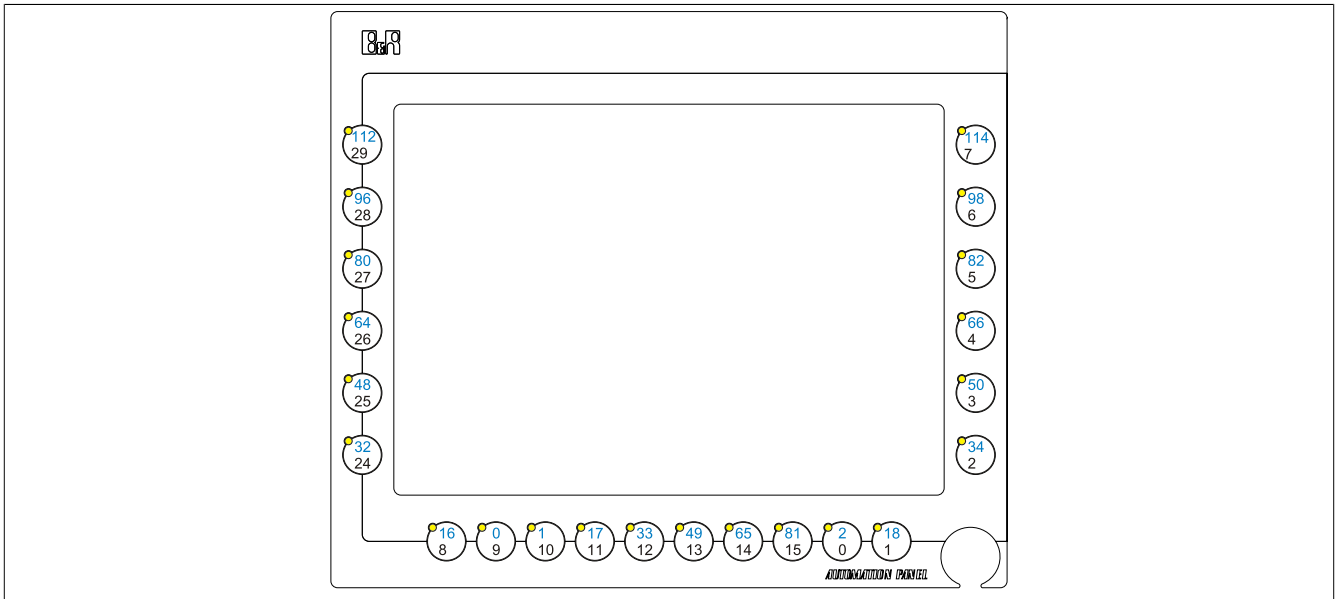

Figure 105: 5AP980.1043-01 - Hardware numbers

9.2 Automation Panel 15" XGA

9.2.1 Automation Panel 5AP951.1505-01 / 5AP981.1505-01

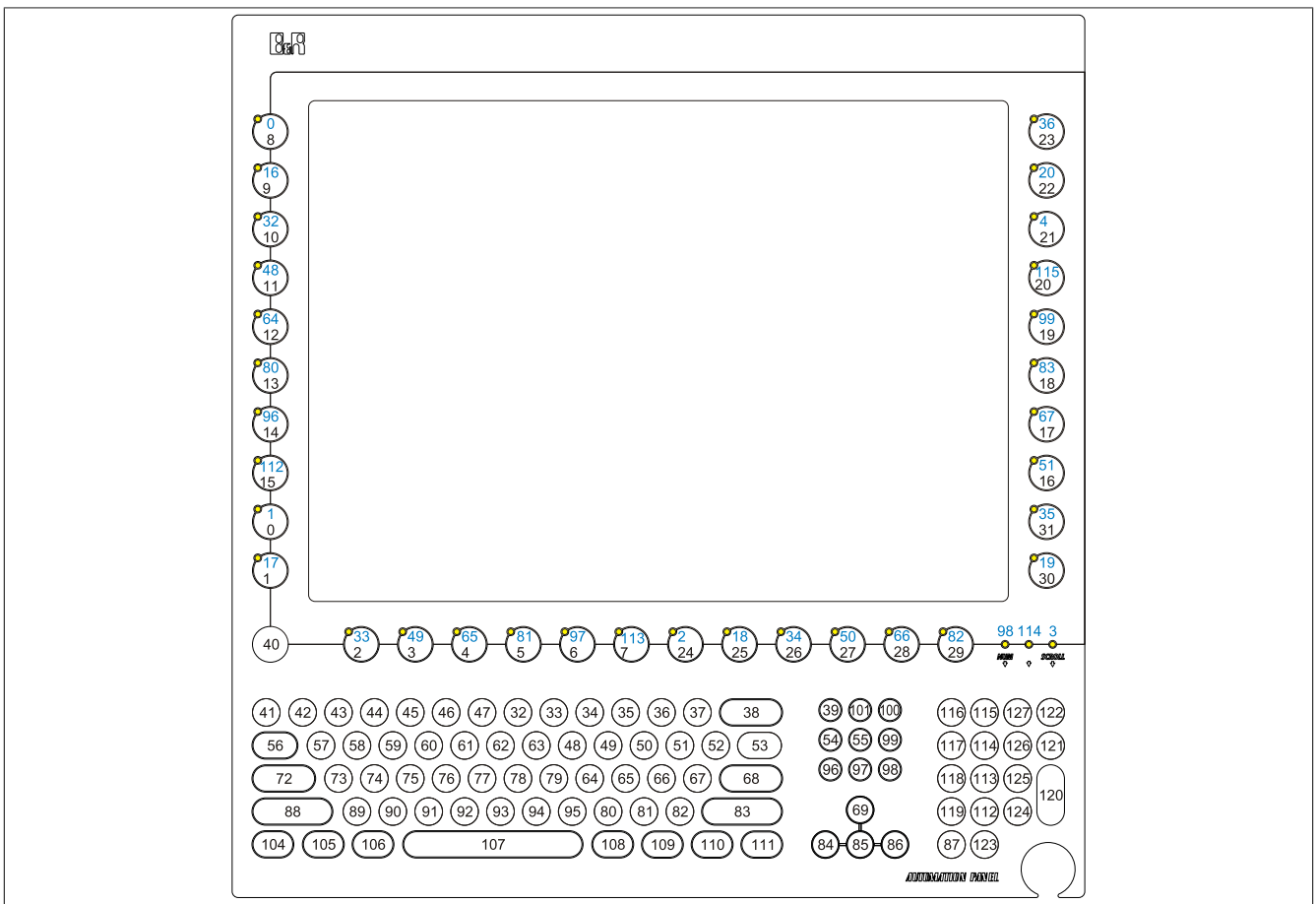

Figure 106: 5AP951.1505-01 / 5AP981.1505-01 - Hardware numbers

9.2.2 Automation Panel 5AP980.1505-01

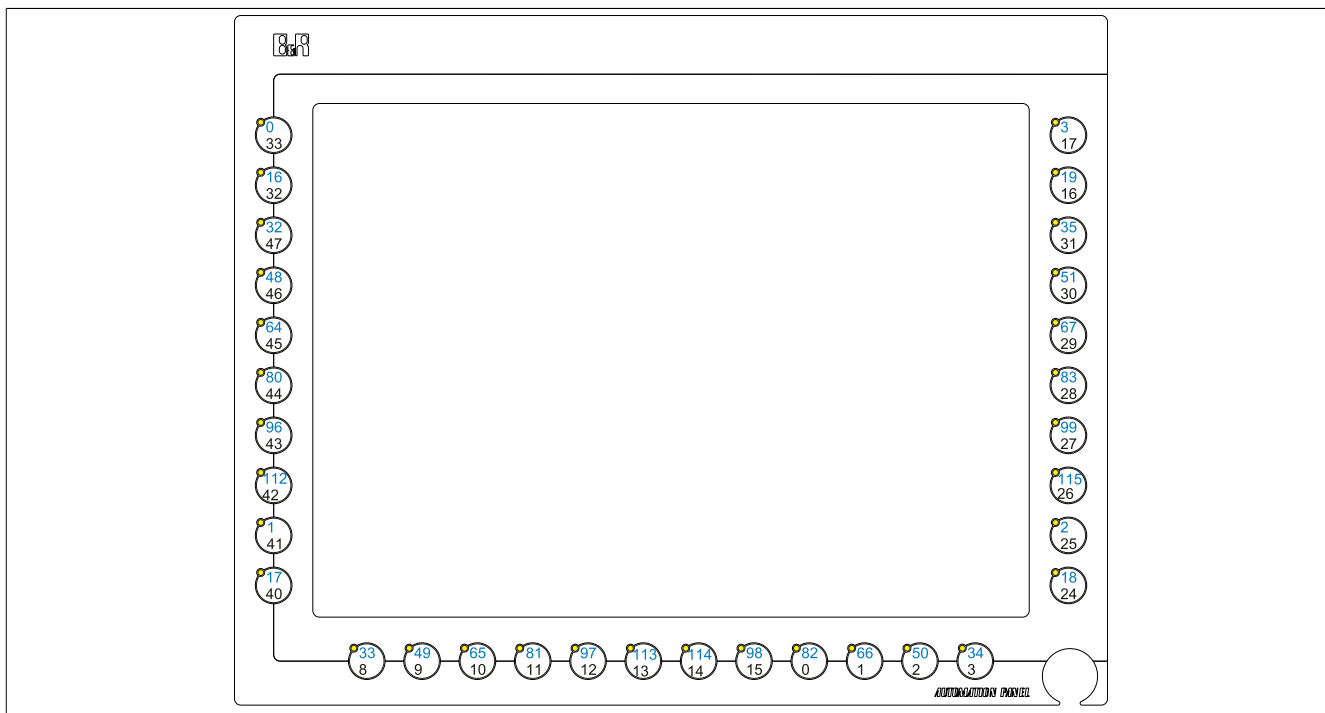

Figure 107: 5AP980.1505-01 - Hardware numbers

10 Touch screen calibration

B&R touch screen devices are equipped with a touch controller that supports hardware calibration. As a result, devices are pre-calibrated when delivered. This is an advantageous feature when replacing devices of the same model or type since it avoids having to recalibrate the new device. Nevertheless, calibrating the device is still recommended in order to achieve the best results and to better adapt the touch screen to the user's preferences.

Regardless of this, the touch screen will have to be calibrated once during or following the installation of the touch screen driver.

10.1 Windows XP Professional

After installing Windows XP Professional on the device, the touch screen driver must be installed in order to operate the touch screen. The necessary driver is available in the Downloads section of the B&R website (www.br-automation.com).

10.2 Windows XP Embedded

After starting Windows XP Embedded on the device for the first time (first boot agent), the touch screen driver must be installed in order to operate the touch screen. The necessary driver is available in the Downloads section of the B&R website www.br-automation.com.

10.3 Windows Embedded Standard 2009

After starting Windows Embedded Standard 2009 on the Panel PC or Power Panel for the first time (first boot agent), the corresponding touch screen driver is installed automatically.

On all other devices, the touch screen driver must be installed in order to operate the touch screen. The necessary driver is available in the Downloads section of the B&R website (www.br-automation.com).

10.4 Windows Embedded Standard 7 Embedded / Premium

A touch screen driver will be installed automatically if a touch controller is detected during the Windows Embedded Standard 7 installation.

The touch screen driver must be installed manually if a touch controller was not detected during the Windows Embedded Standard 7 setup or if an Automation Panel 800/900/9x3/9xD has been connected after setup. The necessary driver is available in the Downloads section of the B&R website (www.br-automation.com).

10.5 Windows CE

Windows CE starts the touch screen calibration sequence during its first boot in its default configuration (i.e. delivered state).

10.6 Windows 7 Professional / Ultimate

After installing Windows 7 on the device, the touch screen driver must be installed in order to operate the touch screen. The necessary driver is available in the Downloads section of the B&R website (www.br-automation.com).

10.7 Windows Embedded 8.1 Industry Pro

After starting Windows Embedded 8.1 Industry Pro on the Panel PC for the first time, the corresponding touch screen driver is installed automatically.

On all other devices, the touch screen driver must be installed in order to operate the touch screen. The necessary driver is available in the Downloads section of the B&R website (www.br-automation.com).

10.8 Automation Runtime / Visual Components

The touch screen must be calibrated once for the customer application when commissioning the device and project.

11 Tips for extending the service life of the display

11.1 Backlight

The service life of the backlight is specified by its "half-brightness time". For example, a specified operating time of 50,000 hours means that the display would still retain 50% of its brightness after this time.

11.1.1 How can the service life of the backlight be extended?

- By setting the display brightness to the lowest value that is still comfortable for the eyes
- By using dark images
- By reducing the brightness by 50%, which can result in an approximately 50% increase in the half-brightness time

11.2 Screen burn-in

Screen burn-in refers to the "burning in" of a static image on a display after being displayed for a prolonged period of time. Nevertheless, static images are not the only cause of screen burn-in. Screen burn-in is also referred to as burn-in effect, image retention, memory effect, memory sticking or ghost image.

There are basically two types:

- Area type: This type of screen burn-in is indicated by a dark gray image. The effect will disappear if the display is switched off for a long period of time.
- Line type: This type of screen burn-in can cause lasting damage.

11.2.1 What causes screen burn-in?

- Static images
- No screensaver
- Sharp transitions in contrast (e.g. black/white)
- High ambient temperatures
- Operation outside of specifications

11.2.2 How can screen burn-in be avoided?

- By constantly changing between static and dynamic images
- By avoiding excessive brightness differences between foreground and background elements
- By using colors with similar brightness
- By using complementary colors in follow-up images
- By using a screensaver

12 Pixel errors

Information:

Displays may contain defective pixels (dead/stuck pixels) that result from the manufacturing process. These flaws are not grounds for reclamation or initiating a warranty claim.

Chapter 4 • Software

1 B&R Automation Device Interface (ADI) - Control Center

The ADI (Automation Device Interface) enables access to specific functions on B&R devices. Settings for devices can be read and configured using the B&R Control Center applet in the Control Panel.

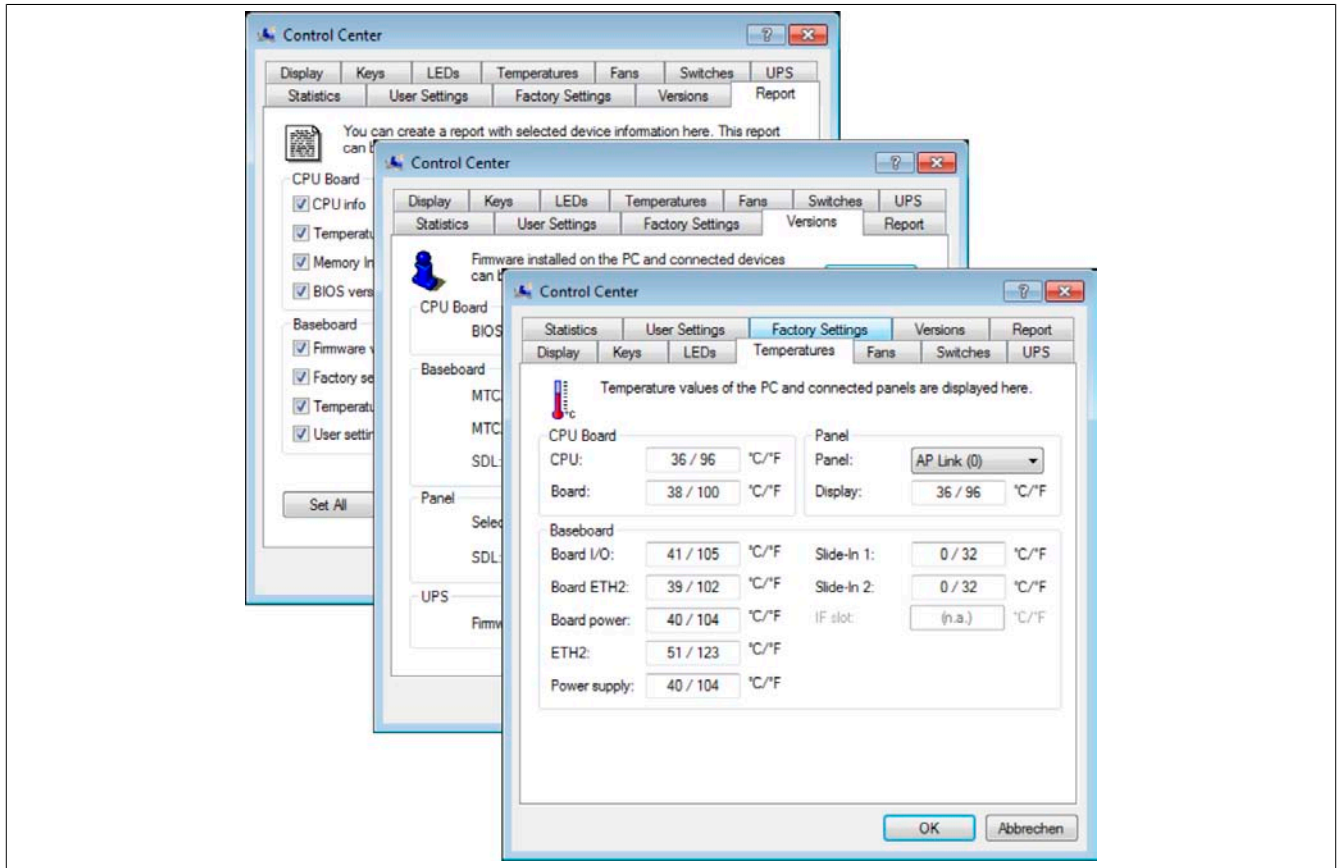

Figure 108: ADI Control Center screenshots - Examples

Information:

The temperature and voltage values (e.g. CPU temperature, core voltage, battery voltage) shown in the corresponding ADI window represent uncalibrated values for informational purposes. They cannot be used to draw any conclusions about hardware alarms or error conditions. The hardware components used have automatic diagnostic functions that can be applied in the event of error.

1.1 Functions

Information:

The functions provided by the Automation Device Interface (ADI) - Control Center vary according to the device series.

- Changing display-specific parameters
- Reading device-specific keys
- Updating the key configuration
- Enabling device-specific LEDs on a membrane keypad or keys
- Reading and calibrating control devices (e.g. key switches, handwheels, joysticks, potentiometers)
- Reading temperatures, fan speeds, statistical data and switch settings
- Reading operating hours (power-on hours)

- Reading user and factory settings
- Reading software versions
- Updating and backing up BIOS and firmware
- Creating reports about the current system (support assistance)
- Setting the SDL equalizer value when adjusting SDL cables
- Changing the user serial ID

Supports the following systems:

- Automation PC 510
- Automation PC 511
- Automation PC 620
- Automation PC 810
- Automation PC 820
- Automation PC 910
- Automation PC 2100
- Panel PC 300
- Panel PC 700
- Panel PC 725
- Panel PC 800
- Panel PC 900
- Panel PC 2100
- Power Panel 100/200
- Power Panel 300/400
- Power Panel 500
- Mobile Panel 40/50
- Mobile Panel 100/200
- Connected Automation Panel 800
- Connected Automation Panel 900

1.2 Installation

A detailed description of the Control Center can be found in the integrated help system. The B&R Automation Device Interface (ADI) driver (also contains Control Center) is available at no charge in the Downloads section of the B&R website (www.br-automation.com).

1. Download and unzip the .zip archive.
2. Close all applications.
3. Run the Setup.exe file (e.g. double-click on it in Explorer).

Information:

The ADI driver is already included in B&R images of embedded operating systems.

If a more current ADI driver version exists (see the Downloads section of the B&R website), it can be installed later. It is important that Enhanced Write Filter (EWF) is disabled for this.

2 B&R Automation Device Interface (ADI) Development Kit

This software can be used to access B&R Automation Device Interface (ADI) functions directly from Windows applications created in one of the following development environments:

- Microsoft Visual C++ 6.0
- Microsoft Visual Basic 6.0
- Microsoft Embedded Visual C++ 4.0
- Microsoft Visual Studio 2008 (or newer)

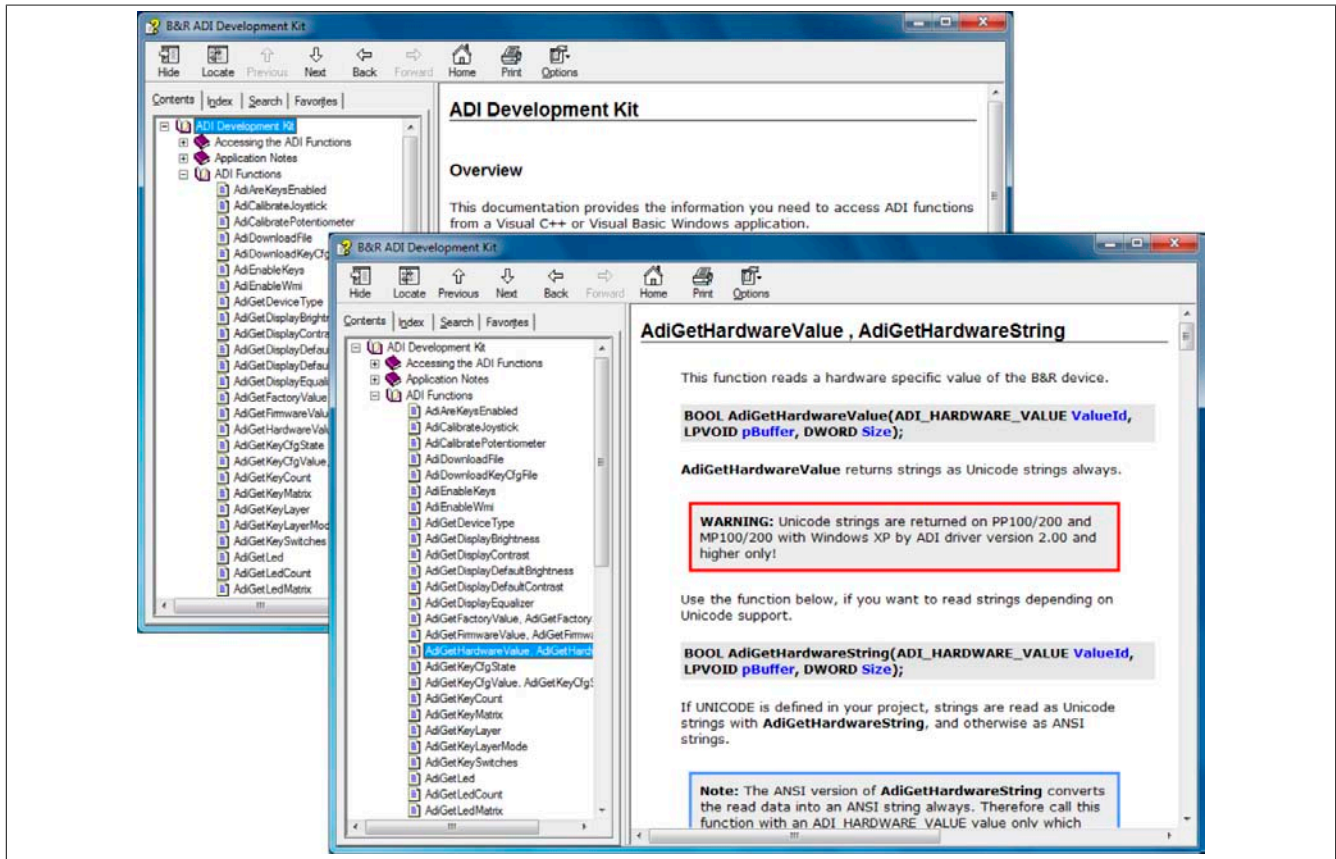

Figure 109: ADI Development Kit Screenshots (Version 3.70)

Features:

- One Microsoft Visual Basic module with ADI function declarations
- Header files and import libraries for Microsoft Visual C++
- Help files for Visual Basic and Visual C++
- Sample projects for Visual Basic and Visual C++
- ADI DLL (for application testing if no ADI driver is installed)

The following systems are supported (version 3.70 and higher):

- Automation PC 510
- Automation PC 511
- Automation PC 620
- Automation PC 810
- Automation PC 820
- Automation PC 910
- Automation PC 2100
- Panel PC 300
- Panel PC 700
- Panel PC 800
- Panel PC 900
- Panel PC 2100

- Power Panel 100/200
- Power Panel 300/400
- Power Panel 500
- Mobile Panel 40/50
- Mobile Panel 100/200

The ADI driver installed on the stated product series must be suitable for that device. The ADI driver is already included in B&R images of embedded operating systems.

A detailed description of how to use ADI functions can be found in the help system.

The B&R Automation Device Interface (ADI) development kit is available at no cost in the Downloads section of the B&R website (www.br-automation.com).

3 B&R Automation Device Interface (ADI) .NET SDK

This software can be used to access B&R Automation Device Interface (ADI) functions directly from .NET applications created using Microsoft Visual Studio 2005 or later.

Supported programming languages:

- Visual Basic
- Visual C++
- Visual C#

System requirements

- Development system: PC with Windows XP or Windows 7 and
 - Microsoft Visual Studio 2005 (or newer)
 - Microsoft .NET Framework 2.0 and/or Microsoft .NET Compact Framework 2.0 (or newer)

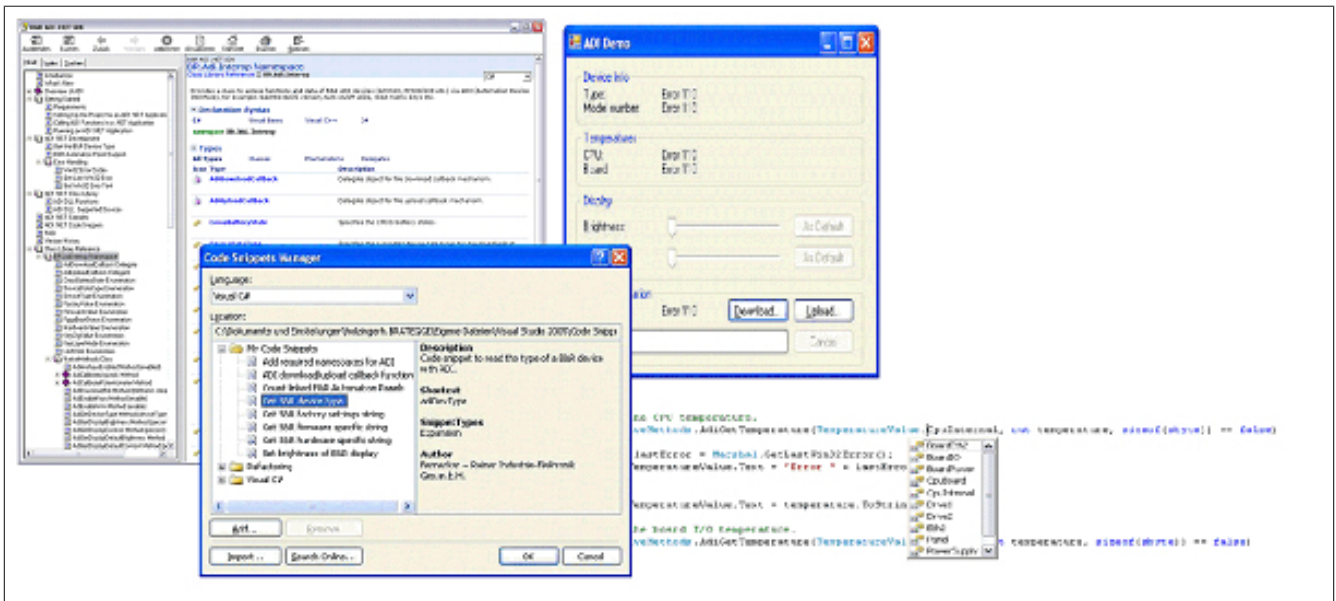

Figure 110: ADI .NET SDK screenshots (version 2.10)

Features (version 2.10 and higher)

- ADI .NET class library
- Help files in HTML Help 1.0 format (.chm), MS Help 2.0 format (.HxS) and MS Help Viewer format (.MSHC) (help documentation is in English only)
- Sample projects and code snippets for Visual Basic, Visual C++ and Visual C#
- ADI DLL (for application testing if no ADI driver is installed)

The following systems are supported (version 2.10 and higher):

- Automation PC 510
- Automation PC 511
- Automation PC 620
- Automation PC 810
- Automation PC 820
- Automation PC 910
- Automation PC 2100
- Panel PC 300
- Panel PC 700
- Panel PC 800
- Panel PC 900
- Panel PC 2100
- Power Panel 100/200
- Power Panel 300/400

- Power Panel 500
- Mobile Panel 40/50
- Mobile Panel 100/200

The ADI driver installed on the stated product series must be suitable for that device. The ADI driver is already included in B&R images of embedded operating systems.

A detailed description of how to use ADI functions can be found in the help system.

The ADI .NET SDK is available in the Downloads section of the B&R website (www.br-automation.com).

4 B&R Key Editor

On display devices, it is often necessary to adapt the function keys and LEDs directly to the application software being used. The B&R Key Editor makes it quick and easy to implement a unique configuration for the application.

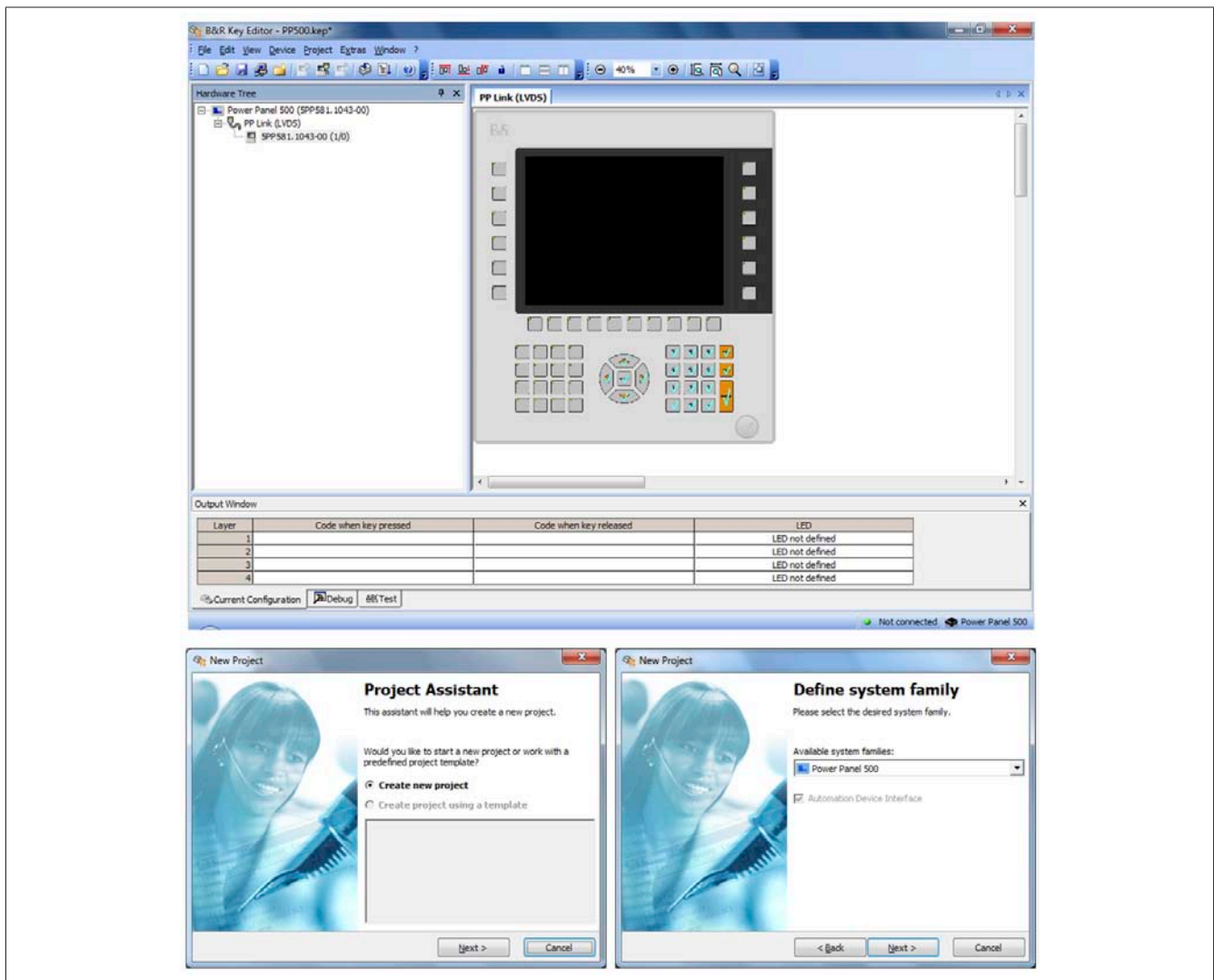

Figure 111: B&R Key Editor screenshots (version 3.50)

Features:

- Configuration of normal keyboard keys (A, B, C, etc.)
- Keyboard shortcuts (CTRL+C, SHIFT+DEL, etc.) using only one key
- Special key functions (change brightness, etc.)
- Assignment of functions to LEDs (HDD access, power, etc.)
- 4 assignments possible per key (using layers)
- Configuration of the panel locking time when multiple Automation Panel 900 devices are connected to Automation PC and Panel PC devices.

The following systems are supported (version 3.50):

- Automation PC 510
- Automation PC 511
- Automation PC 620
- Automation PC 810
- Automation PC 820
- Automation PC 910
- Automation PC 2100
- Automation Panel 800
- Automation Panel 830

- Automation Panel 900
- Automation Panel 9x3 / 9xD
- IPC2000, IPC2001, IPC2002
- IPC5000, IPC5600
- IPC5000C, IPC5600C
- Mobile Panel 40/50
- Mobile Panel 100/200
- Panel PC 300
- Panel PC 700
- Panel PC 800
- Panel PC 900
- Panel PC 2100
- Power Panel 100/200
- Power Panel 300/400
- Power Panel 500

A detailed guide for configuring keys and LEDs can be found in the B&R Key Editor's help system. The B&R Key Editor is available at no cost in the Downloads section of the B&R website (www.br-automation.com). It can also be found on the B&R HMI Drivers & Utilities DVD (model number 5SWHMI.0000-00).

Chapter 5 • Standards and certifications

1 Standards and guidelines

1.1 CE mark



Product complies with all applicable directives and their harmonized EN standards.

1.2 EMC directive

These devices meet the requirements of EC directive "2004/108/EC Electromagnetic compatibility" and are designed for the following areas:

EN 61131-2:2007	Programmable logic controllers - Part 2: Equipment requirements and tests
EN 61000-6 -2:2005	Electromagnetic compatibility (EMC) - Part 6-2: Generic standards - Immunity for industrial environments
EN 61000-6 -4:2007	Electromagnetic compatibility (EMC) - Part 6-4: Generic standards - Emission standard for industrial environments

1.3 Low voltage directive

These devices satisfy the requirements of EC directive "2006/95/EC Low voltage directive" and are designed for the following areas:

EN 61131-2:2007	Programmable logic controllers - Part 2: Equipment requirements and tests
EN 60204-1:2006 + A1:2009	Safety of machinery - Electrical equipment of machines - Part 1: General requirements

2 Certifications

Danger!

A complete system can only receive certification if **ALL** of the individual components it includes have the applicable certifications. If an individual component is being used that **DOES NOT** have an applicable certification, then the complete system **WILL NOT** receive certification.

B&R products and services comply with applicable standards. This includes international standards from organizations such as ISO, IEC and CENELEC, as well as national standards from organizations such as UL, CSA, FCC, VDE, ÖVE, etc. We are committed to ensuring the reliability of our products in an industrial environment.

Unless otherwise specified, the following certifications apply:

2.1 UL certification



Products with this mark have been tested by Underwriters Laboratories and are listed as "Industrial Control Equipment". This mark is valid for the USA and Canada and simplifies the certification of your machines and systems in these areas.

Underwriters Laboratories (UL) in accordance with the UL508 standard - 17th Edition Canadian (CSA) standard in accordance with C22.2 No. 142-M1987

2.2 GOST-R



Products with this mark have been certified by an accredited testing laboratory and have been approved for import to the Russian Federation (based on CE compliance).

2.3 GL certification (Germanischer Lloyd)



Some B&R products have been certified by Germanischer Lloyd and are approved for use in maritime environments. GL certificates (type approval) are generally accepted by other classification societies during ship acceptance procedures.

Germanischer Lloyd (GL) in accordance with standard GL 2003 (Category C EMC 1)

Category C concerns devices that are protected from the effects of weather. EMC 1 defines the radiated and conducted emission limits for devices installed on a ship's bridge.

Information:

Line filter **5AC804.MFLT-00** is absolutely mandatory in the supply line when used in a maritime environment. Additional information can be found on page **Connecting to the end device**.

The following table lists revisions from which GL certification applies to individual components.

Model number	Short description	GL beginning with rev.
5AP920.1505-01	Automation Panel AP920; 15" XGA color TFT display with touch screen (resistive); 3 USB 2.0 interfaces; insert for Automation Panel Link; IP65 protection (from front). 24 VDC.	K0
5AP920.1906-01	Automation Panel AP920; 19" SXGA color TFT display with touch screen (resistive); 3 USB 2.0 interfaces; insert for Automation Panel Link; IP65 protection (from front). 24 VDC.	N0
5CADVI.0018-00	DVI-D cable, 1.8 m	D0
5CADVI.0050-00	DVI-D cable, 5 m	D0
5CADVI.0100-00	DVI-D cable, 10 m	D0

Table 67: GL certifications

Model number	Short description	GL beginning with rev.
5CASDL.0018-00	SDL cable, 1.8 m	D0
5CASDL.0050-00	SDL cable, 5 m	D0
5CASDL.0100-00	SDL cable, 10 m	D0
5CASDL.0150-00	SDL cable, 15 m	D0
5CASDL.0200-00	SDL cable, 20 m	D0
5CASDL.0250-00	SDL cable, 25 m	D0
5CASDL.0300-00	SDL cable, 30 m	D0
5CASDL.0018-01	SDL cable with 45° connector, 1.8 m	D0
5CASDL.0050-01	SDL cable with 45° connector, 5 m	D0
5CASDL.0100-01	SDL cable with 45° connector, 10 m	D0
5CASDL.0150-01	SDL cable with 45° connector, 15 m	D0
5CASDL.0018-03	SDL flex cable, 1.8 m	D0
5CASDL.0050-03	SDL flex cable, 5 m	D0
5CASDL.0100-03	SDL flex cable, 10 m	D0
5CASDL.0150-03	SDL flex cable, 15 m	D0
5CASDL.0200-03	SDL flex cable, 20 m	D0
5CASDL.0250-03	SDL flex cable, 25 m	D0
5CASDL.0300-03	SDL flex cable, 30 m	D0
5CASDL.0300-13	SDL flex cable with extender, 30 m	D0
5CASDL.0400-13	SDL flex cable with extender, 40 m	D0
5CASDL.0430-13	SDL flex cable with extender, 43 m	D0
5DL DVI.1000-01	Automation Panel Link DVI receiver; connections for DVI-D, RS232 and USB 2.0 (Type B); 24 VDC (order screw clamp 0TB103.9 or cage clamp 0TB103.91 separately).	D0
5DLS DL.1000-00	Automation Panel Link SDL receiver; connection for SDL In; transmission of display, touch screen, USB 1.1, matrix key and service data; 24 VDC (order screw clamp 0TB103.9 or cage clamp 0TB103.91 separately).	F0
0TB103.9	24 VDC supply voltage plug, 3-pin female, 3.31 mm ² screw clamp, protected against vibration by the screw flange	D0
0TB103.91	24 VDC supply voltage plug, 3-pin female, 3.31 mm ² cage clamp, protected against vibration by the screw flange	D0
5AC804.MFLT-00	Line filter	D0

Table 67: GL certifications

Certificate no. 11 859 - 10 HH

			
<h2>Type Approval Certificate</h2>			
This is to certify that the undernoted product(s) has/have been tested in accordance with the relevant requirements of the GL Type Approval System.			
Certificate No.	11 859 - 10 HH		
Company	Bernecker + Rainer Industrie-Elektronik GmbH B&R Straße 1 5142 Eggelsberg, Austria		
Product Description	Automation Panel		
Type	Automation Panel 920 15" and 19" Display		
Environmental Category	C, EMC1		
Technical Data / Range of Application	Display unit: 5AP920.1505-01 (15") 5AP920.1906-01 (19")		
	Display link: 5DLDVI.XXXX-XX 5DLSDL.XXXX-XX		
	Display cable: 5CADVI.XXXX-XX 5CASDL.XXXX-XX		
Test Standard	Guidelines for the Performance of Type Approvals Chapter 2, Edition 2003 Guidelines for the Use of Computers and Computer Systems, Edition 1994		
Documents	Test report : Mikes E34680-00-00HO, Mikes S34732-00-00MJ, Mikes E34679-00-00HO, Mikes S34733-00-00MJ, Prüfbeschreibung V 1.50 (06.10.2010)		
Remarks	Filter 5AC804.MFLT-00 to be used in DC power line		
Valid until	2016-01-03		
Page	1 of 1	Type Approval Symbol	
File No.	I.B.05		
Hamburg,	2011-01-04		
Germanischer Lloyd	 Dr. Joannis Papanuskas	 Burkhard Lilienthal	
<small>This certificate is issued on the basis of "Guidelines for the Performance of Type Approvals Part 1, Procedure".</small>			

Figure 112: GL certificate no. 11 859 - 10 HH

3 SDL flex cable test description

3.1 Torsion

3.1.1 Test structure

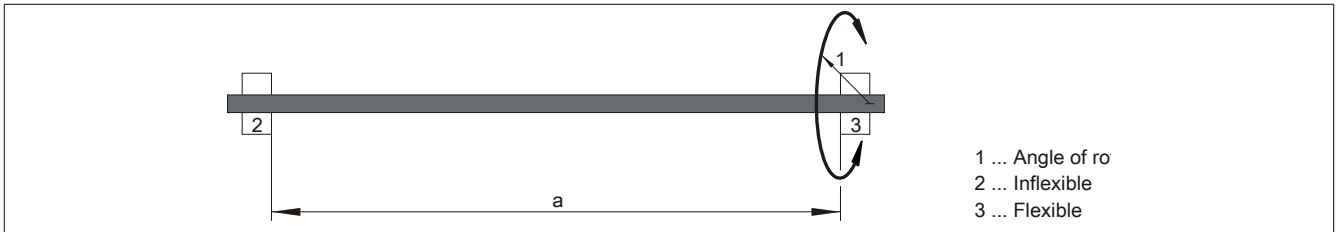

Figure 113: Test structure - Torsion

3.1.2 Test conditions

- Distance a: 450 mm
- Angle of rotation: $\pm 85^\circ$
- Speed: 50 cycles/minute
- Note: The cable was clamped down twice in the machine.

3.1.3 Individual tests

- Visible pixel errors: The minimum equalizer setting was determined at the beginning of the test. This is the value between 0-15 at which no more pixel errors are visible. Changes to the the equalizer setting caused by mechanical load are noted.
- Touch screen functionality
- USB mouse functionality
- Hot plugging functionality tested by disconnecting the USB cable
- After a test duration of 150,000 cycles, testing was concluded with a result of "OK".

3.2 Cable drag chain

3.2.1 Test structure

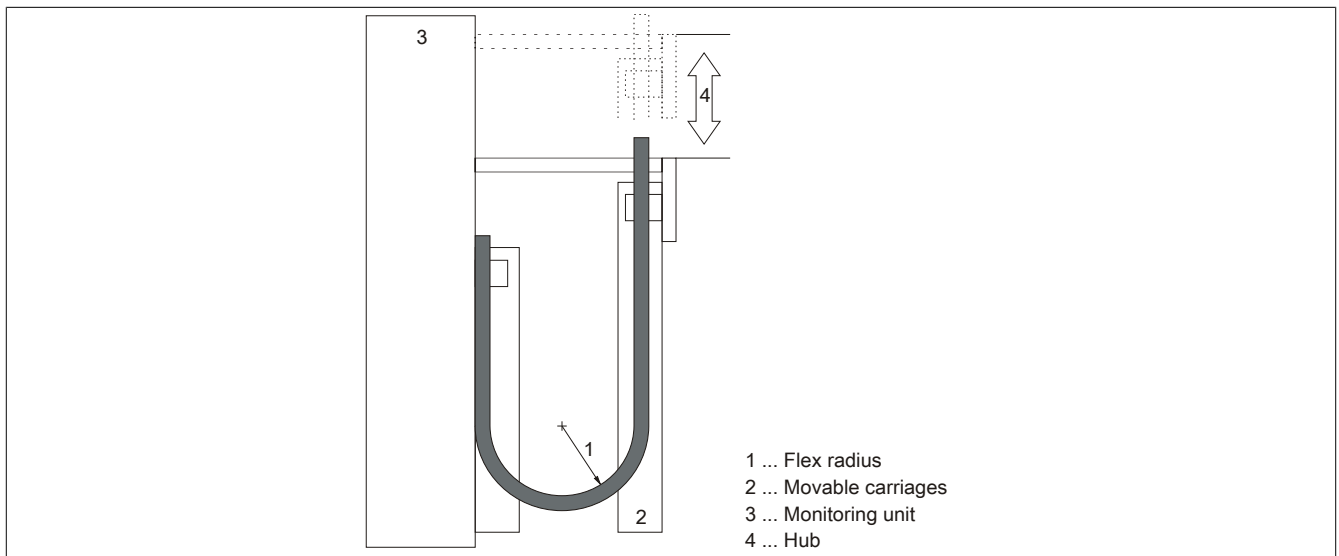

Figure 114: Test structure - Cable drag chain

3.2.2 Test conditions

- Flex radius: 180 mm (= 15 x cable diameter)
- Hub: 460 mm
- Speed: 4800 cycles / hour
- Note: The cable was clamped down twice in the machine.

3.2.3 Individual tests

- Visible pixel errors: The minimum equalizer setting was determined at the beginning of the test. This is the value between 0-15 at which no more pixel errors are visible. Changes to the the equalizer setting caused by mechanical load are noted.
- Touch screen functionality
- USB mouse functionality
- Hot plugging functionality tested by disconnecting the USB cable
- After a test duration of 300,000 cycles, testing was concluded with a result of "OK".

Chapter 6 • Accessories

The following accessories have successfully completed functional testing at B&R and are approved for use with this device. Nevertheless, it is important to observe any limitations that may apply to the complete system when operated with other individual components. When operating the complete system, the specifications for the individual components must be observed.

All components listed in this manual have been subjected to extensive system and compatibility testing and are approved for use. B&R can make no guarantee regarding the functionality of non-approved accessories.

1 Power connectors

1.1 0TB103.9x

1.1.1 General information

This single-row, 3-pin 0TB103 terminal block is used to connect the voltage supply.

1.1.2 Order data

Model number	Short description	Figure
	Terminal blocks	
0TB103.9	Connector 24 VDC - 3-pin female - Screw clamps 3.31 mm ²	
0TB103.91	Connector 24 VDC - 3-pin female - Cage clamps 3.31 mm ²	

Table 68: 0TB103.9, 0TB103.91 - Order data

1.1.3 Technical data

Information:

The following characteristics, features and limit values only apply to this accessory and can deviate from those specified for the complete system. The data specifications for the complete system take precedence over those of individual components.

Product ID	0TB103.9	0TB103.91
General information		
Certification		Yes
CE		Yes
cULus		
cULus HazLoc Class 1 Division 2	Yes ¹⁾	Yes ²⁾
GL	Yes ¹⁾	Yes ³⁾
Terminal block		
Note	Protected against vibration by the screw flange Nominal values according to UL	Protected against vibration by the screw flange Nominal values according to UL
Number of pins	3 (female)	
Type of terminal clamp	Screw clamps	Cage clamps ⁴⁾
Cable type	Only copper wires (no aluminum wires!)	
Distance between contacts	5.08 mm	
Connection cross section		
AWG wire	26 to 14 AWG	26 to 12 AWG
Wire end sleeves with plastic covering		0.20 to 1.50 mm ²
Solid wires		0.20 to 2.50 mm ²
Fine strand wires	0.20 to 1.50 mm ²	0.20 to 2.50 mm ²
With wire end sleeves		0.20 to 1.50 mm ²
Tightening torque	0.4 Nm	-

Table 69: 0TB103.9, 0TB103.91 - Technical data

Product ID	0TB103.9	0TB103.91
Electrical characteristics		
Nominal voltage	300 V	
Nominal current ⁵⁾	10 A / contact	
Contact resistance	≤5 mΩ	

Table 69: 0TB103.9, 0TB103.91 - Technical data

- 1) Yes, although applies only if all components installed within the complete system have this certification
- 2) Yes, although applies only if all components installed within the complete system have this certification and the complete system itself carries the corresponding mark.
- 3) Yes, although applies only if all components installed within the complete system have this certification.
- 4) Cage clamp terminal blocks cannot be used side-by-side.
- 5) The limit data for each I/O module must be taken into consideration.

2 Terminal blocks

2.1 0TB103.8

2.1.1 General information

This single-row, 3-pin 0TB103 terminal block is used to connect the voltage supply.

2.1.2 Order data

Model number	Short description	Figure
	Terminal blocks	
0TB103.8	Connector, 24 VDC, 3-pin male, screw clamp, 3.31 mm ² , protected against vibration by the screw flange	

Table 70: 0TB103.8 - Order data

2.1.3 Technical data

Product ID	0TB103.8
General information	
Certification CE	Yes
Terminal block	
Note	Protected against vibration by the screw flange Nominal values according to UL
Number of pins	3 (male)
Type of terminal clamp	Screw clamps
Cable type	Only copper wires (no aluminum wires!)
Distance between contacts	5.08 mm
Connection cross section	
AWG wire	22 to 12 AWG
Wire end sleeves with plastic covering	0.20 to 1.50 mm ²
Solid wires	0.20 to 2.50 mm ²
Fine strand wires	0.20 to 1.50 mm ²
With wire end sleeves	0.20 to 1.50 mm ²
Electrical characteristics	
Nominal voltage	300 V
Nominal current ¹⁾	10 A / contact
Contact resistance	≤5 mΩ

Table 71: 0TB103.8 - Technical data

1) The limit data for each I/O module must be taken into consideration.

3 Legend strip templates

3.1 5AC900.104X-xx

3.2 General information

Automation Panel devices with keys are delivered with slide-in labels, some of which are already captioned (F1, F2, etc.). The slide-in label slots are accessible on the back of the Automation Panel device (above and below).

Printable slide-in labels (A4 format) can be ordered from B&R (see Table 12 "Accessories - Model numbers" on page 25). They can be printed using a standard laser printer (b/w or color) in a temperature range from -40 to +125°C. A template for printing legend strips in CorelDRAW versions 7, 9 and 10 can be downloaded from the B&R website (www.br-automation.com). These print templates can also be found on the HMI Drivers & Utilities DVD (model number 5SWHMI.0000-00).

3.3 Order data

Model number	Short description	Figure
	Accessories	
5AC900.104X-03	Legend Strips Template 10,4" for Automation Panel 5AP951.1043-01 and 5AP981.1043-01; for 1 device.	Image not found for 5AC900.104X-03!
5AC900.104X-04	Legend Strips Template 10,4" for Automation Panel 5AP952.1043-01 and 5AP982.1043-01; for 1 device.	
5AC900.104X-05	Legend Strips Template 10,4" for Automation Panel 5AP980.1043-01; for 3 devices.	
5AC900.150X-01	Legend Strips Template 15,0" for Automation Panel 5AP951.1505-01, 5AP980.1505-01 and 5AP981.1505-01 and Panel PC 5PC781.1505-00; for 4 devices.	

Table 72: 5AC900.104X-03, 5AC900.104X-04, 5AC900.104X-05, 5AC900.150X-01 - Order data

4 Cables

4.1 DVI cables

4.1.1 5CADVI.0xxx-00

4.1.1.1 General information

5CADVI.0xxx-00 DVI cables are designed for use in inflexible applications.

Caution!

Power must be disconnected before connecting or disconnecting cables.

4.1.1.2 Order data

Model number	Short description	Figure
	DVI cables	
5CADVI.0018-00	DVI-D cable - 1.8 m	
5CADVI.0050-00	DVI-D cable - 5 m	
5CADVI.0100-00	DVI-D cable - 10 m	

Table 73: 5CADVI.0018-00, 5CADVI.0050-00, 5CADVI.0100-00 - Order data

4.1.1.3 Technical data

Product ID	5CADVI.0018-00	5CADVI.0050-00	5CADVI.0100-00
General information			
Certification			
CE		Yes	
cULus		Yes	
GOST-R		Yes	
GL		Yes ¹⁾	
Cable construction			
Wire cross section		AWG 28	
Shield		Individual cable pairs and entire cable	
Complete shielding		Tinned copper braiding, optical coverage >86%	
Outer sheathing			
Material		PVC	
Color		Beige	
Labeling		AWM STYLE 20276 80°C 30V VW1 DVI DIGITAL SINGLE LINK DER AN	
Connector			
Type		2x DVI-D (18+1), male	
Connection cycles		100	
Locating screw tightening torque		Max. 0.5 Nm	
Electrical characteristics			
Conductor resistance		Max. 237 Ω/km	
Insulation resistance		Min. 100 MΩ/km	
Mechanical characteristics			
Dimensions			
Length	1.8 m ±50 mm	5 m ±80 mm	10 m ±100 mm
Diameter		Max. 8.5 mm	
Flex radius	≥5x cable diameter (male connector - ferrite bead and ferrite bead - ferrite bead)		
Weight	Approx. 260 g	Approx. 460 g	Approx. 790 g

Table 74: 5CADVI.0018-00, 5CADVI.0050-00, 5CADVI.0100-00 - Technical data

1) Yes, although applies only if all components installed within the complete system have this certification.

4.1.1.4 Flex radius specifications

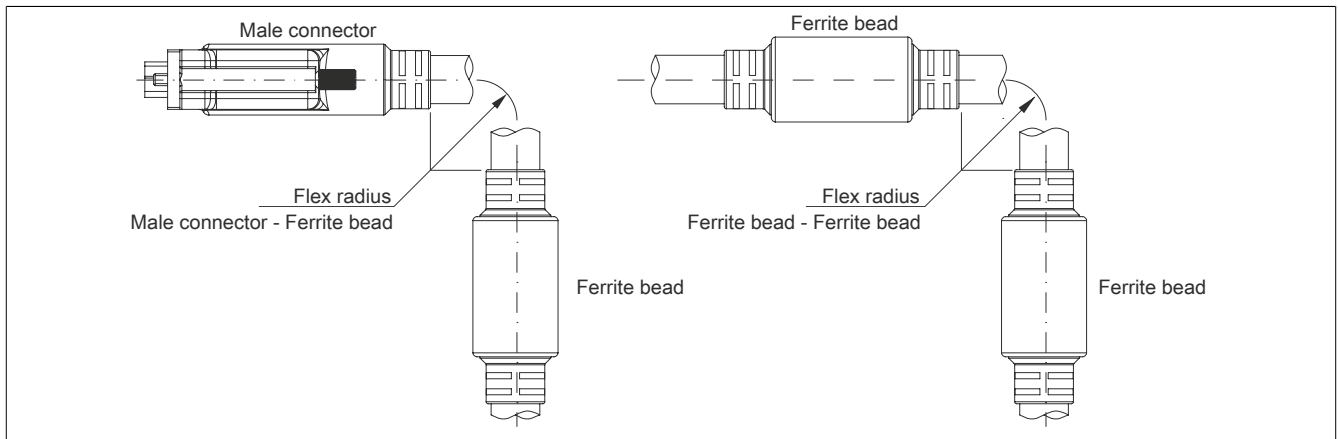

Figure 115: Flex radius specifications

4.1.1.5 Dimensions

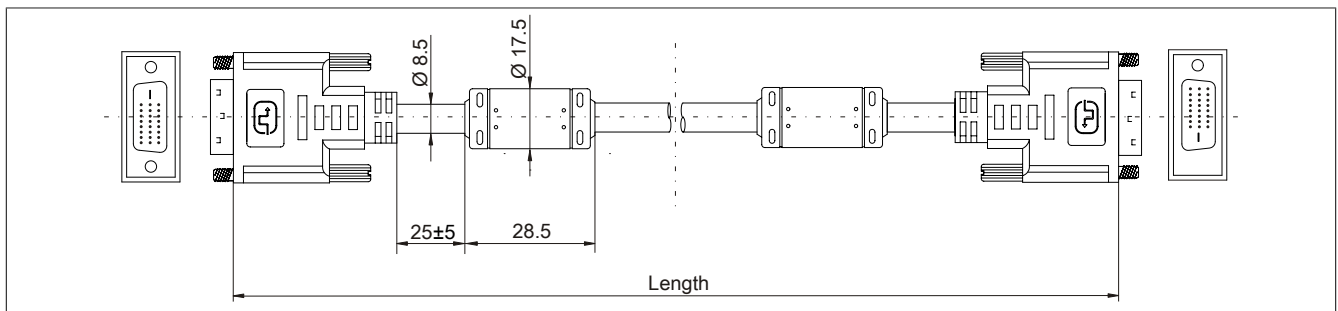

Figure 116: 5CADVI.0xxx-00 - Dimensions

4.1.1.6 Cable pinout

Warning!

Field-assembled cables must be wired according to these specifications.

If a field-assembled cable is used, B&R cannot guarantee that it will function properly. All cables provided by B&R are guaranteed to function properly, however.

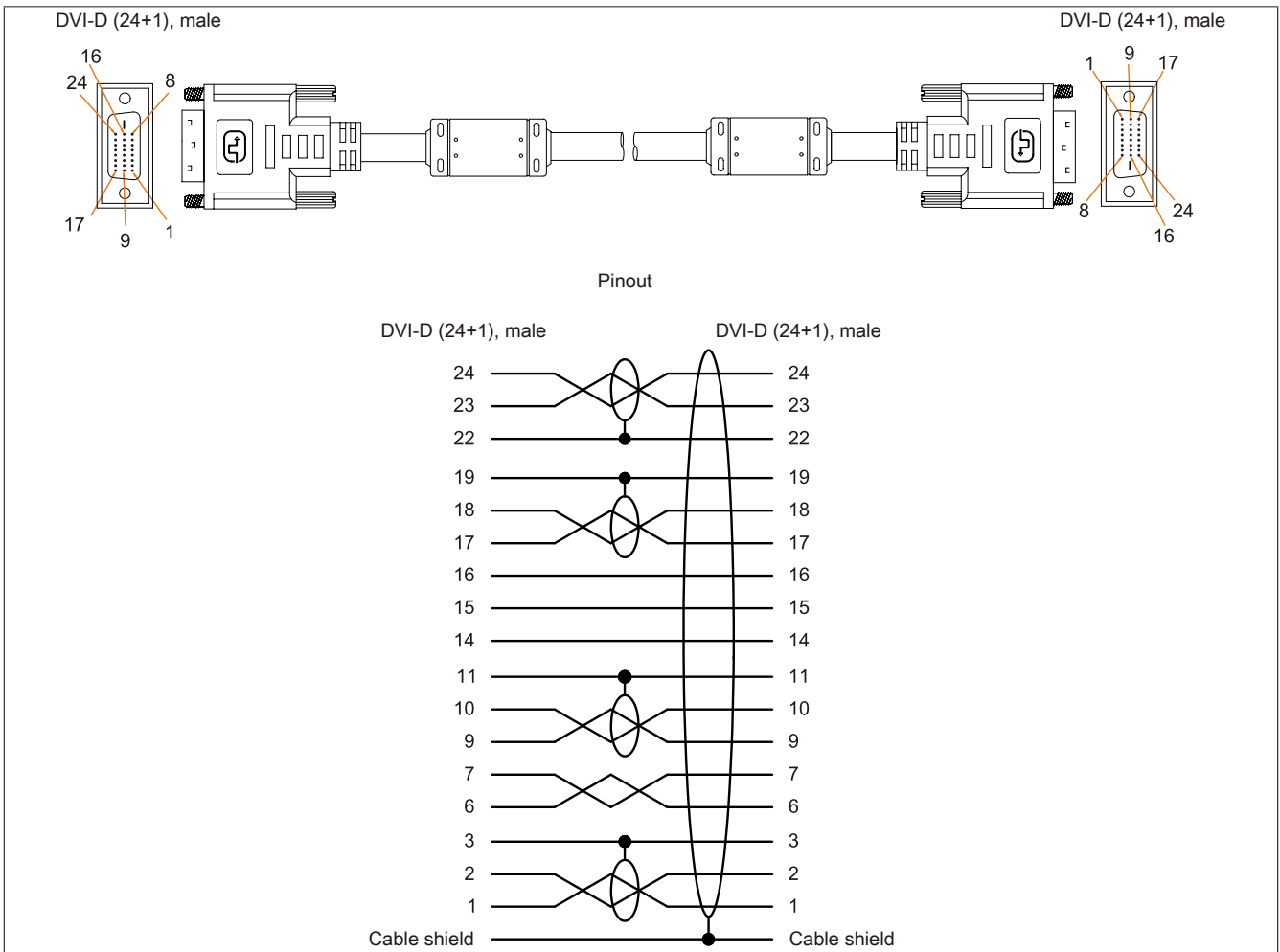

Figure 117: 5CADVI.0xxx-00 - Pinout

4.2 SDL cables

4.2.1 5CASDL.0xxx-00

4.2.1.1 General information

5CASDL.0xxx-00 SDL cables are designed for use in inflexible applications. 5CASDL.0xxx-03 SDL flex cables are required for flexible applications (e.g. swing arm systems).

Caution!

Power must be disconnected before connecting or disconnecting cables.

4.2.1.2 Order data

Model number	Short description	Figure
	SDL cables	
5CASDL.0018-00	SDL cable - 1.8 m	
5CASDL.0050-00	SDL cable - 5 m.	
5CASDL.0100-00	SDL cable, 10 m	
5CASDL.0150-00	SDL cable, 15 m	
5CASDL.0200-00	SDL cable, 20 m	
5CASDL.0250-00	SDL cable, 25 m	
5CASDL.0300-00	SDL cable, 30 m	

Table 75: 5CASDL.0018-00, 5CASDL.0050-00, 5CASDL.0100-00, 5CASDL.0150-00, 5CASDL.0200-00, 5CASDL.0250-00, 5CASDL.0300-00 - Order data

4.2.1.3 Technical data

Product ID	5CASDL. 0018-00	5CASDL. 0050-00	5CASDL. 0100-00	5CASDL. 0150-00	5CASDL. 0200-00	5CASDL. 0250-00	5CASDL. 0300-00
General information							
Certification				Yes			
CE				Yes			
cULus				Yes			
GOST-R				Yes			
GL	Yes ¹⁾	Yes ²⁾			Yes ¹⁾		
Cable construction							
Wire cross section	AWG 28			AWG 24			
Shield	Individual cable pairs and entire cable						
Complete shielding	Tinned copper braiding, optical coverage >85%						
Outer sheathing							
Material	PVC						
Color	Black						
Labeling	E74020-C (UL) AWM STYLE 20176 80°C 30V VW-1 DVI DIGITAL LINK						
Connector							
Type	2x DVI-D (24+1), male						
Connection cycles	100						
Contacts	Gold-plated						
Mechanical protection	Metal cover with crimped stress relief						
Locating screw tightening torque	Max. 0.5 Nm						
Electrical characteristics							
Conductor resistance							
AWG 24	-			≤93 Ω/km			
AWG 28	≤237 Ω/km			-			
Insulation resistance	Min. 10 MΩ/km						
Mechanical characteristics							
Dimensions							
Length	1.8 m ±30 mm	5 m ±30 mm	10 m ±50 mm	15 m ±100 mm	20 m ±100 mm	25 m ±100 mm	30 m ±100 mm
Diameter	Typ. 8.6 ±0.2 mm Max. 9 mm			Typ. 11 ±0.2 mm Max. 11.5 mm			
Flex radius	≥5x cable diameter (male connector - ferrite bead and ferrite bead - ferrite bead)						

Table 76: 5CASDL.0018-00, 5CASDL.0050-00, 5CASDL.0100-00, 5CASDL.0150-00, 5CASDL.0200-00, 5CASDL.0250-00, 5CASDL.0300-00 - Technical data

Product ID	5CASDL.0018-00	5CASDL.0050-00	5CASDL.0100-00	5CASDL.0150-00	5CASDL.0200-00	5CASDL.0250-00	5CASDL.0300-00
Flexibility	Limited flexibility, valid for ferrite bead - ferrite bead (tested 100 cycles with 5x cable diameter, 20 cycles/minute)	Limited flexibility; valid for ferrite bead - ferrite bead (tested 100 cycles with 5x cable diameter, 20 cycles / minute)	Limited flexibility, valid for ferrite bead - ferrite bead (tested 100 cycles with 5x cable diameter, 20 cycles/minute)				
Weight	Approx. 300 g	Approx. 580 g	Approx. 1500 g	Approx. 2250 g	Approx. 2880 g	Approx. 4800 g	Approx. 5520 g

Table 76: 5CASDL.0018-00, 5CASDL.0050-00, 5CASDL.0100-00, 5CASDL.0150-00, 5CASDL.0200-00, 5CASDL.0250-00, 5CASDL.0300-00 - Technical data

- 1) Yes, although applies only if all components installed within the complete system have this certification.
- 2) Yes, although applies only if all components installed within the complete system have this certification

4.2.1.4 Flex radius specifications

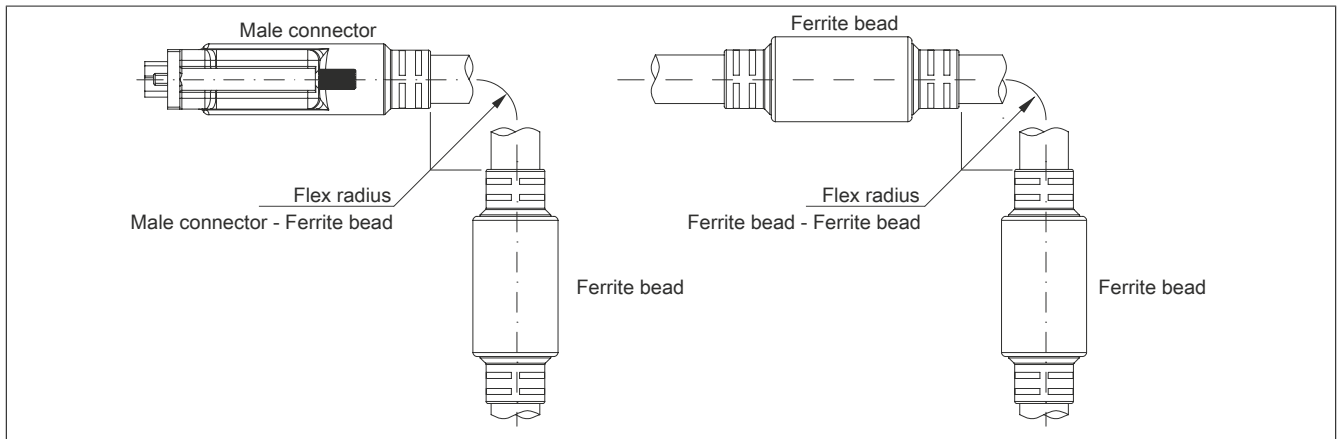

Figure 118: Flex radius specifications

4.2.1.5 Dimensions

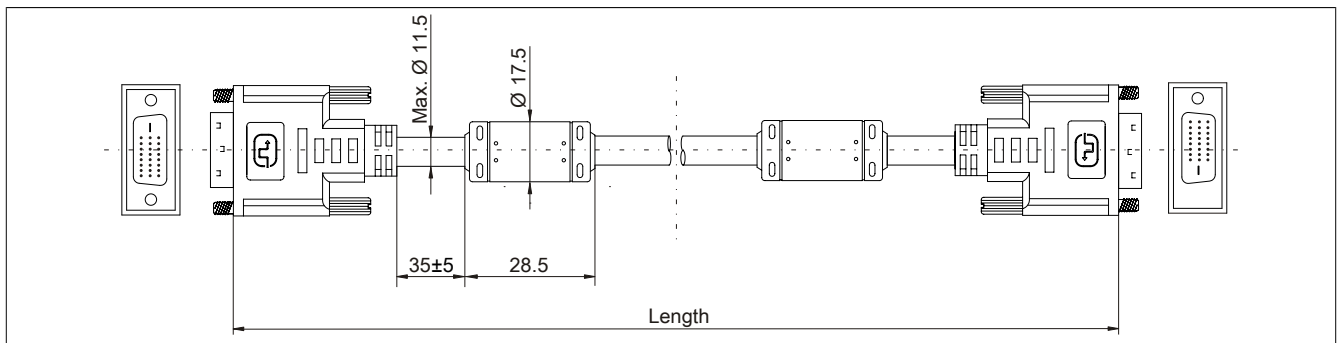

Figure 119: 5CASDL.0xxx-00- Dimensions

4.2.1.6 Cable pinout

Warning!

Field-assembled cables must be wired according to these specifications.

If a field-assembled cable is used, B&R cannot guarantee that it will function properly. All cables provided by B&R are guaranteed to function properly, however.

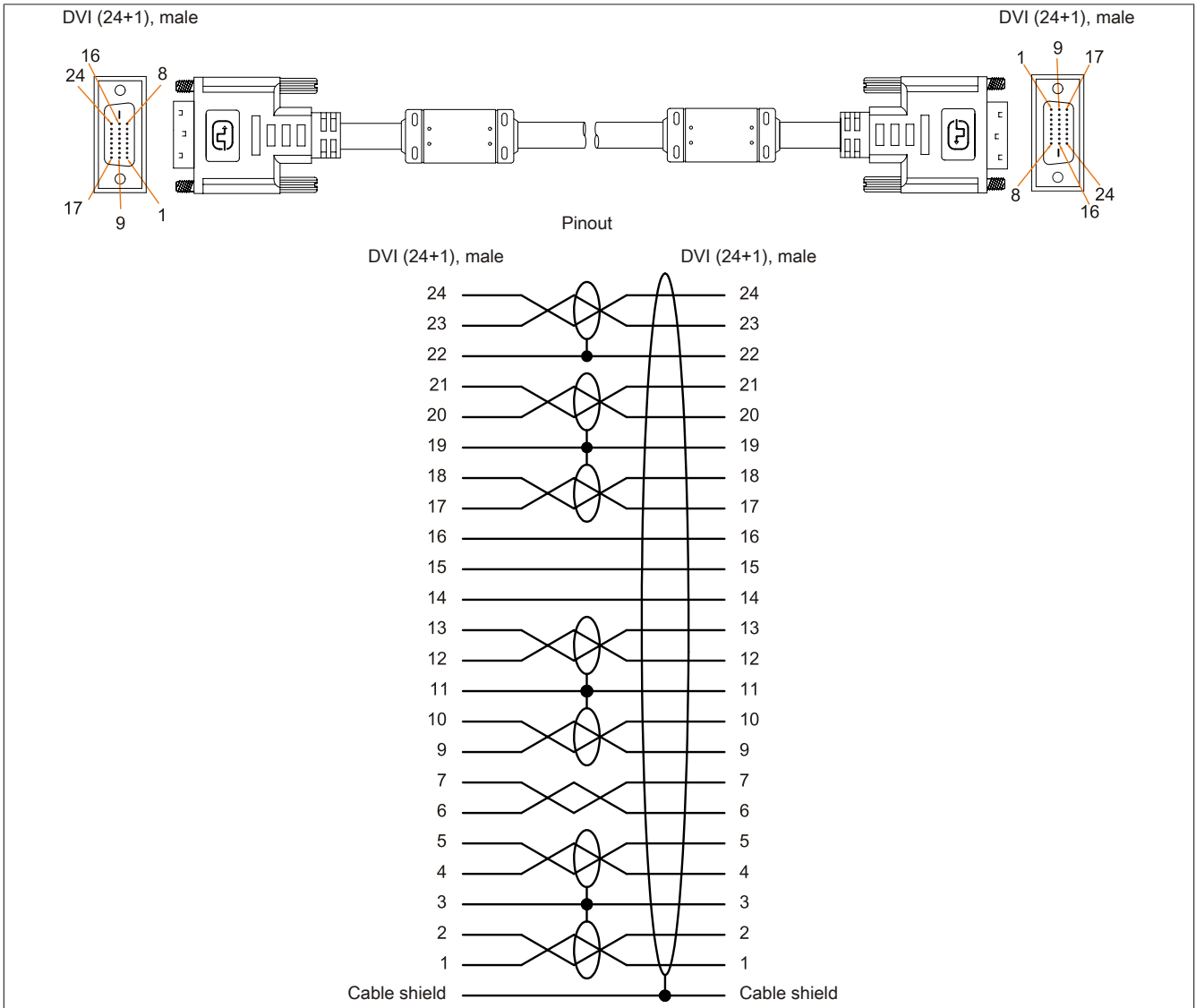

Figure 120: 5CASDL.0xxx-00 - Pinout

4.3 SDL cables with 45° male connector

4.3.1 5CASDL.0xxx-01

4.3.1.1 General information

5CASDL.0xxx-01 SDL cables with a 45° connector are designed for use in inflexible applications.

Caution!

Power must be disconnected before connecting or disconnecting cables.

4.3.1.2 Order data

Model number	Short description	Figure
	SDL cables with 45° connectors	
5CASDL.0018-01	SDL cable - 45° connector - 1.8 m	
5CASDL.0050-01	SDL cable with 45° male connector, 5 m	
5CASDL.0100-01	SDL cable with 45° male connector, 10 m	
5CASDL.0150-01	SDL cable with 45° male connector, 15 m	

Table 77: 5CASDL.0018-01, 5CASDL.0050-01, 5CASDL.0100-01, 5CASDL.0150-01 - Order data

4.3.1.3 Technical data

Product ID	5CASDL.0018-01	5CASDL.0050-01	5CASDL.0100-01	5CASDL.0150-01
General information				
Certification				
CE			Yes	
cULus			Yes	
GOST-R			Yes	
GL			Yes ¹⁾	
Cable construction				
Wire cross section	AWG 28		AWG 24	
Shield	Individual cable pairs and entire cable			
Complete shielding	Tinned copper braiding, optical coverage >85%			
Outer sheathing				
Material	PVC			
Color	Black			
Connector				
Type	2x DVI-D (24+1), male			
Connection cycles	100			
Contacts	Gold-plated			
Mechanical protection	Metal cover with crimped stress relief			
Locating screw tightening torque	Max. 0.5 Nm			
Electrical characteristics				
Conductor resistance				
AWG 24	-		≤93 Ω/km	
AWG 28	≤237 Ω/km		-	
Insulation resistance	Min. 10 MΩ/km			
Mechanical characteristics				
Dimensions				
Length	1.8 m ±30 mm	5 m ±50 mm	10 m ±100 mm	15 m ±100 mm
Diameter	Max. 9 mm		Max. 11.5 mm	
Flex radius	≥5x cable diameter (male connector - ferrite bead and ferrite bead - ferrite bead)			
Flexibility	Limited flexibility, valid for ferrite bead - ferrite bead (tested 100 cycles with 5x cable diameter, 20 cycles/minute)			
Weight	Approx. 300 g	Approx. 590 g	Approx. 2800 g	Approx. 2860 g

Table 78: 5CASDL.0018-01, 5CASDL.0050-01, 5CASDL.0100-01, 5CASDL.0150-01 - Technical data

1) Yes, although applies only if all components installed within the complete system have this certification.

4.3.1.4 Flex radius specifications

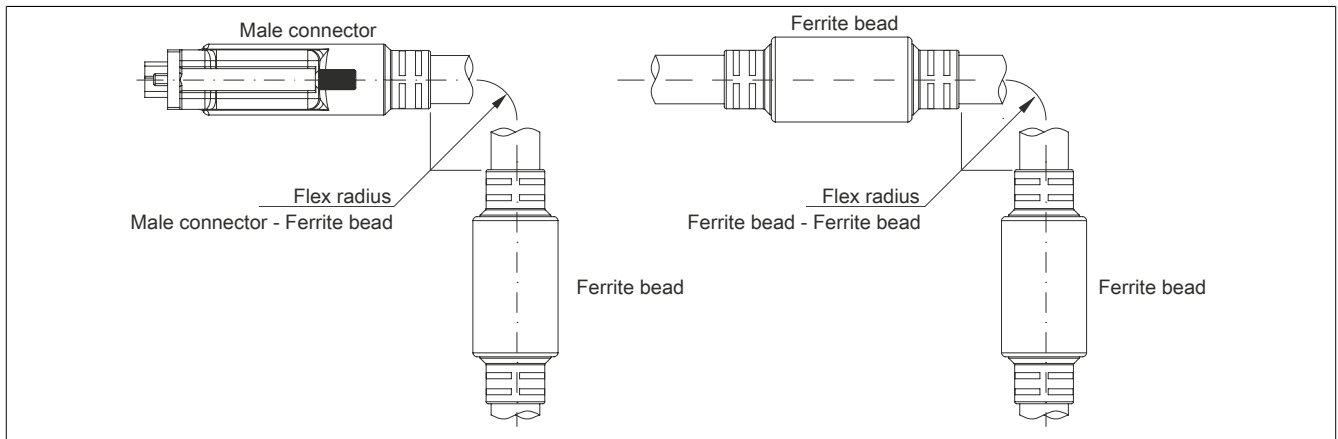

Figure 121: Flex radius specifications

4.3.1.5 Dimensions

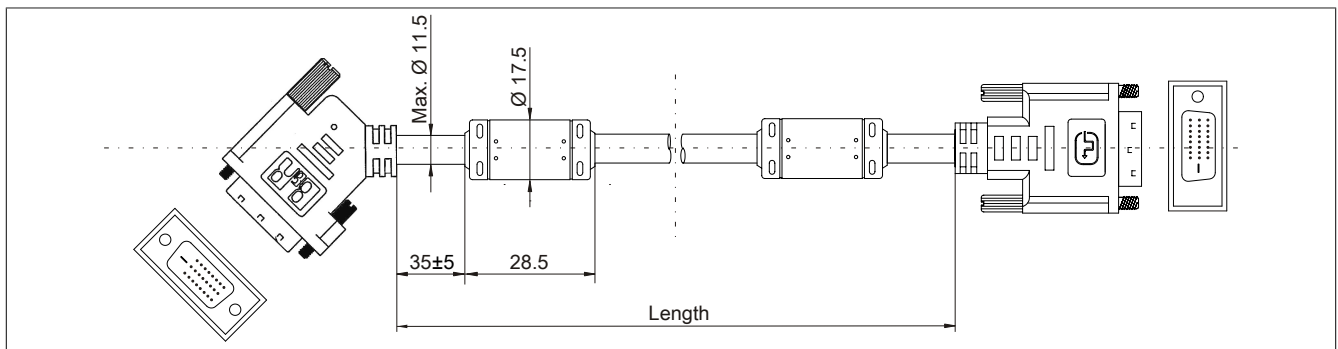

Figure 122: 5CASDL.0xxx-01 - Dimensions

4.3.1.6 Cable pinout

Warning!

Field-assembled cables must be wired according to these specifications.

If a field-assembled cable is used, B&R cannot guarantee that it will function properly. All cables provided by B&R are guaranteed to function properly, however.

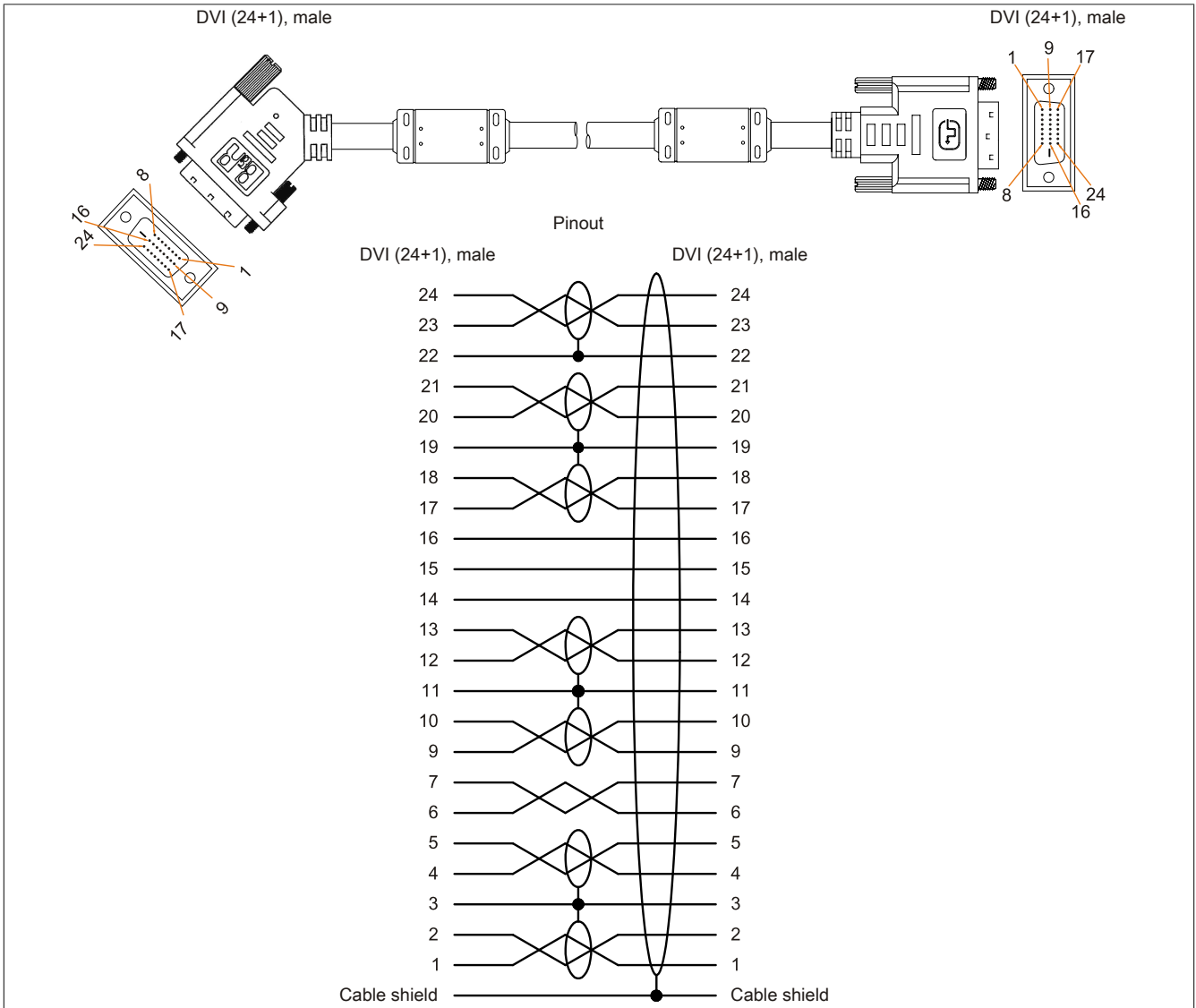

Figure 123: 5CASDL.0xxx-01 - Pinout

4.4 SDL flex cables

4.4.1 5CASDL.0xxx-03

4.4.1.1 General information

5CASDL.0xxx-03 SDL flex cables are designed for use in both inflexible and flexible applications (e.g. swing arm systems).

Caution!

Power must be disconnected before connecting or disconnecting cables.

4.4.1.2 Order data

Model number	Short description	Figure
	SDL flex cables	
5CASDL.0018-03	SDL flex cable - 1.8 m	
5CASDL.0050-03	SDL flex cable, 5 m	
5CASDL.0100-03	SDL flex cable, 10 m	
5CASDL.0150-03	SDL flex cable, 15 m	
5CASDL.0200-03	SDL flex cable, 20 m	
5CASDL.0250-03	SDL flex cable, 25 m	
5CASDL.0300-03	SDL flex cable, 30 m	

Table 79: 5CASDL.0018-03, 5CASDL.0050-03, 5CASDL.0100-03, 5CASDL.0150-03, 5CASDL.0200-03, 5CASDL.0250-03, 5CASDL.0300-03 - Order data

4.4.1.3 Technical data

Product ID	5CASDL. 0018-03	5CASDL. 0050-03	5CASDL. 0100-03	5CASDL. 0150-03	5CASDL. 0200-03	5CASDL. 0250-03	5CASDL. 0300-03
General information							
Certification				Yes			
CE				Yes			
cULus				Yes			
GOST-R				Yes			
GL				Yes ¹⁾			
Cable construction							
Wire cross section				AWG 24 (control wires) AWG 26 (DVI, USB, data)			
Features				Silicone- and halogen-free			
Shield				Individual cable pairs and entire cable			
Complete shielding				Aluminum-clad foil + tinned copper braiding			
Outer sheathing				Special semi-glossy TPU			
Material				Black			
Color				(B&R) SDL Cable (UL) AWM 20236 80°C 30V E 63216			
Labeling							
Connector							
Type				2x DVI-D (24+1), male			
Connection cycles				Min. 200			
Contacts				Gold-plated			
Mechanical protection				Metal cover with crimped stress relief			
Locating screw tightening torque				Max. 0.5 Nm			
Electrical characteristics							
Operating voltage				≤30 V			
Test voltage				1 kV			
Wire/Wire				0.5 kV			
Wire/Shield							
Wave impedance				100 ±10 Ω			
Conductor resistance				≤95 Ω/km			
AWG 24				≤145 Ω/km			
AWG 26							
Insulation resistance				>200 MΩ/km			
Operating conditions							
Approbation				UL AWM 20236 80°C 30 V			
Flame-retardant				In accordance with UL758 (cable vertical flame test)			
Oil and hydrolysis resistance				In accordance with VDE 0282-10			

Table 80: 5CASDL.0018-03, 5CASDL.0050-03, 5CASDL.0100-03, 5CASDL.0150-03, 5CASDL.0200-03, 5CASDL.0250-03, 5CASDL.0300-03 - Technical data

Product ID	5CASDL.0018-03	5CASDL.0050-03	5CASDL.0100-03	5CASDL.0150-03	5CASDL.0200-03	5CASDL.0250-03	5CASDL.0300-03
Environmental conditions							
Temperature							
Storage	-20 to 80°C						
Fixed installation	-20 to 80°C						
Flexible installation	-5 to 60°C						
Mechanical characteristics							
Dimensions							
Length	1.8 m ±20 mm 5 m ±45 mm 10 m ±90 mm 15 m ±135 mm 20 m ±180 mm 25 m ±225 mm 30 m ±270 mm						
Diameter	Max. 12 mm						
Flex radius							
Fixed installation	≥6x cable diameter (from male connector - ferrite bead) ≥10x cable diameter (from ferrite bead - ferrite bead)						
Flexible installation	≥15x cable diameter (from ferrite bead - ferrite bead)						
Flexibility	Flexible, valid for ferrite bead - ferrite bead (tested 300,000 cycles with 15x cable diameter, 4800 cycles/hour)			Flexible; valid for ferrite bead - ferrite bead (tested 300,000 cycles with 15x cable diameter, 4800 cycles/hour)			
Drag chain data							
Flex cycles	300,000						
Speed	4800 cycles/hour						
Flex radius	180 mm, 15x cable diameter			180 mm; 15x cable diameter			
Hub	460 mm						
Weight	Approx. 460 g	Approx. 1020 g	Approx. 1940 g	Approx. 2840 g	Approx. 3740 g	Approx. 4560 g	Approx. 5590 g
Tension							
During operation	≤50 N						
During installation	≤400 N						

Table 80: 5CASDL.0018-03, 5CASDL.0050-03, 5CASDL.0100-03, 5CASDL.0150-03, 5CASDL.0200-03, 5CASDL.0250-03, 5CASDL.0300-03 - Technical data

1) Yes, although applies only if all components installed within the complete system have this certification.

4.4.1.4 Flex radius specifications

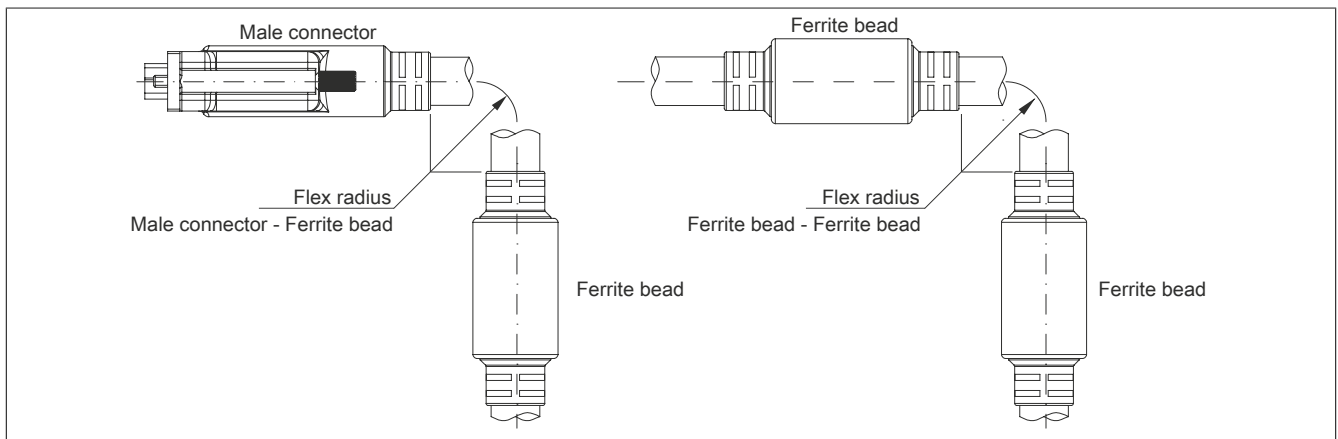

Figure 124: Flex radius specifications

4.4.1.5 Dimensions

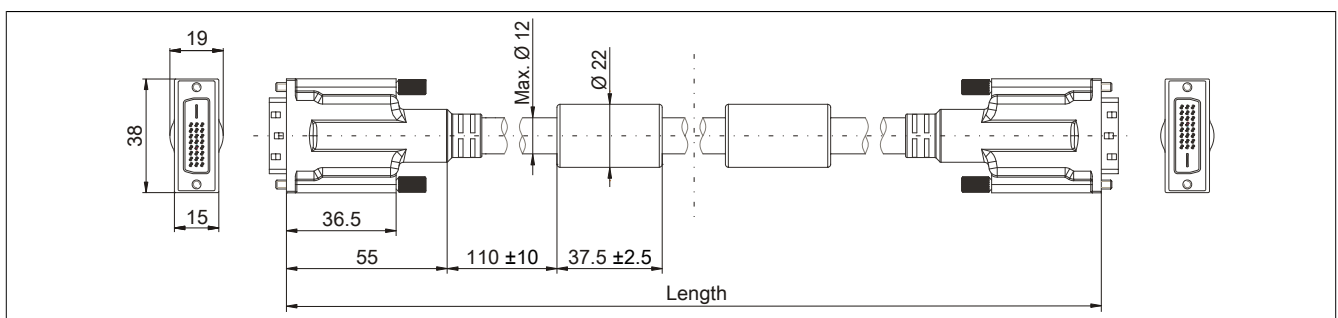

Figure 125: 5CASDL.0xxx-03 - Dimensions

4.4.1.6 Design

Element	Assignment	Cross section
DVI	TMDS data 0	26 AWG
	TMDS data 1	26 AWG
	TMDS data 2	26 AWG
	TMDS cycle	26 AWG
USB	XUSB0	26 AWG
	XUSB1	26 AWG
Data	SDL	26 AWG
Control wires	DDC cycle	24 AWG
	DDC data	24 AWG
	+5 V	24 AWG
	Ground	24 AWG
	Hot plug detect	24 AWG

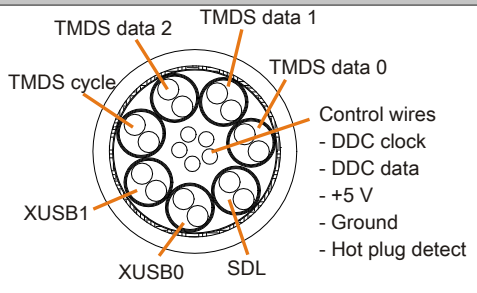

Table 81: 5CASDL.0xxx-03 SDL flex cables - Structure

4.4.1.7 Cable pinout

Warning!

Field-assembled cables must be wired according to these specifications.

If a field-assembled cable is used, B&R cannot guarantee that it will function properly. All cables provided by B&R are guaranteed to function properly, however.

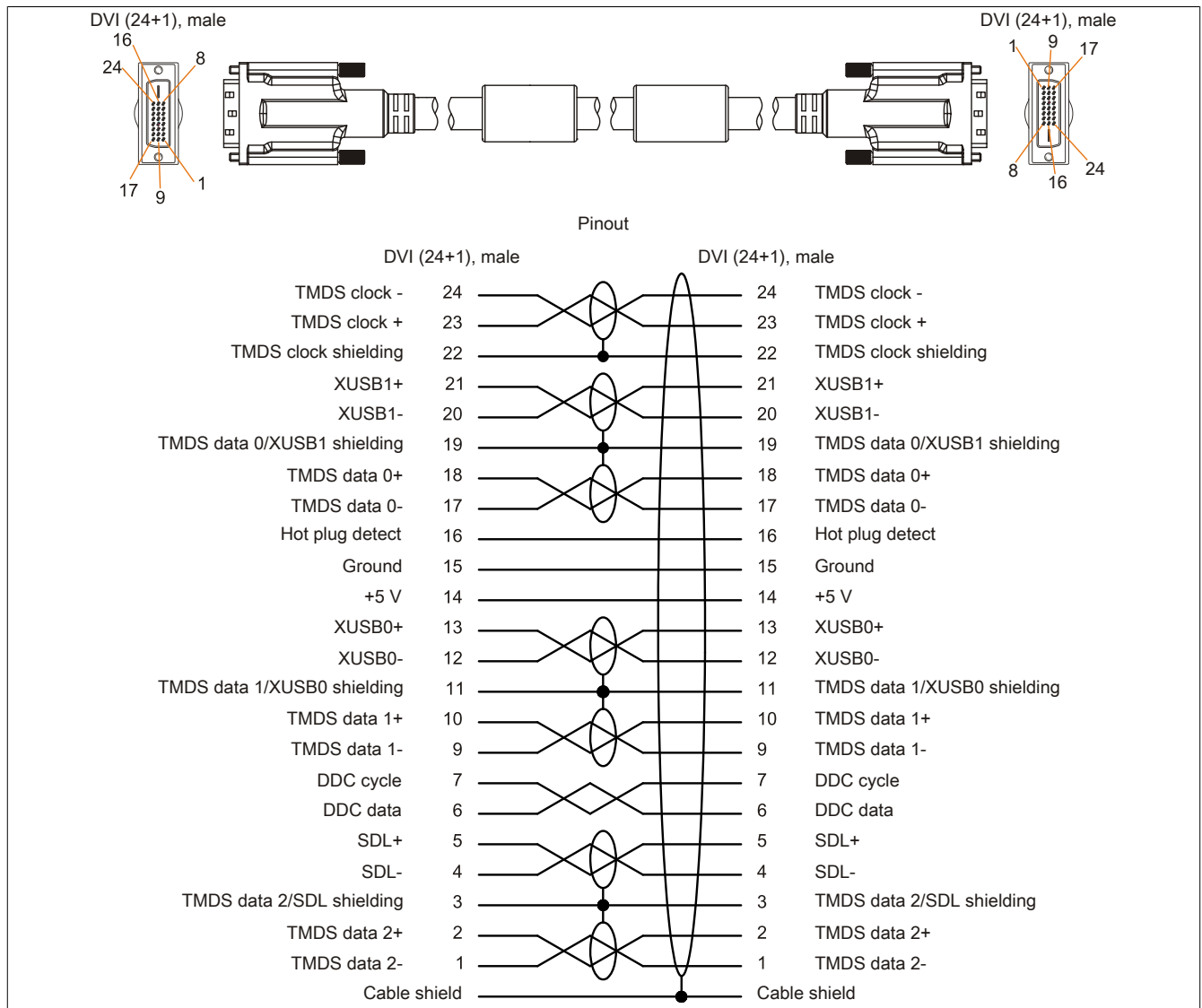

Figure 126: 5CASDL.0xxx-03 - Pinout

4.5 SDL flex cables with extender

4.5.1 5CASDL.0xx0-13

4.5.1.1 General information

5CASDL.0xx0-13 SDL flex cables with an extender are designed for use in both inflexible and flexible applications (e.g. swing arm systems).

Caution!

Power must be disconnected before connecting or disconnecting cables.

4.5.1.2 Order data

Model number	Short description	Figure
	SDL flex cables	
5CASDL.0300-13	SDL flex cable with extender, 30 m	
5CASDL.0400-13	SDL flex cable with extender, 40 m	
5CASDL.0430-13	SDL flex cable with extender, 43 m	

Table 82: 5CASDL.0300-13, 5CASDL.0400-13, 5CASDL.0430-13 - Order data

4.5.1.3 Technical data

Product ID	5CASDL.0300-13	5CASDL.0400-13	5CASDL.0430-13
General information			
Certification		Yes	
CE		Yes	
cULus		Yes	
GOST-R		Yes	
GL		Yes ¹⁾	
Cable construction			
Wire cross section		AWG 24 (control wires) AWG 26 (DVI, USB, data)	
Features		Silicone- and halogen-free	
Shield		Individual cable pairs and entire cable	
Complete shielding		Aluminum-clad foil + tinned copper braiding	
Outer sheathing			
Material		Special semi-glossy TPU	
Color		Black	
Labeling		(B&R) SDL cable (UL) AWM 20236 80°C 30V E63216	
Connector			
Type		2x DVI-D (24+1), male	
Connection cycles		Min. 200	
Contacts		Gold-plated	
Mechanical protection		Metal cover with crimped stress relief	
Locating screw tightening torque		Max. 0.5 Nm	
Electrical characteristics			
Operating voltage		≤30 V	
Test voltage			
Wire/Wire		1 kV	
Wire/Shield		0.5 kV	
Wave impedance		100 ±10 Ω	
Conductor resistance			
AWG 24		≤95 Ω/km	
AWG 26		≤145 Ω/km	
Insulation resistance		>200 MΩ/km	
Operating conditions			
Approbation		UL AWM 20236 80°C 30 V	
Flame-retardant		In accordance with UL758 (cable vertical flame test)	
Oil and hydrolysis resistance		In accordance with VDE 0282-10	
Environmental conditions			
Temperature			
Storage		-20 to 60°C	
Fixed installation		-20 to 60°C	
Flexible installation		-5 to 60°C	

Table 83: 5CASDL.0300-13, 5CASDL.0400-13, 5CASDL.0430-13 - Technical data

Product ID	5CASDL.0300-13	5CASDL.0400-13	5CASDL.0430-13
Mechanical characteristics			
Dimensions			
Length	30 m ±280 mm	40 m ±380 mm	43 m ±410 mm
Diameter		Max. 12 mm	
Extender box			
Width		35 mm	
Length		125 mm	
Height		18.5 mm	
Flex radius			
Fixed installation		≥6x cable diameter (from male connector - ferrite bead) ≥10x cable diameter (from ferrite bead - ferrite bead)	
Flexible installation		≥15x cable diameter (from ferrite bead - ferrite bead)	
Flexibility		Flexible; valid for ferrite bead - ferrite bead (tested 300,000 cycles with 15x cable diameter, 4800 cycles/hour)	
Drag chain data			
Flex cycles		300,000	
Speed		4800 cycles/hour	
Flex radius		180 mm; 15x cable diameter	
Hub		460 mm	
Weight	Approx. 5430 g	Approx. 7200 g	Approx. 7790 g
Tension			
During operation		≤50 N	
During installation		≤400 N	

Table 83: 5CASDL.0300-13, 5CASDL.0400-13, 5CASDL.0430-13 - Technical data

1) Yes, although applies only if all components installed within the complete system have this certification.

4.5.1.4 Flex radius specifications

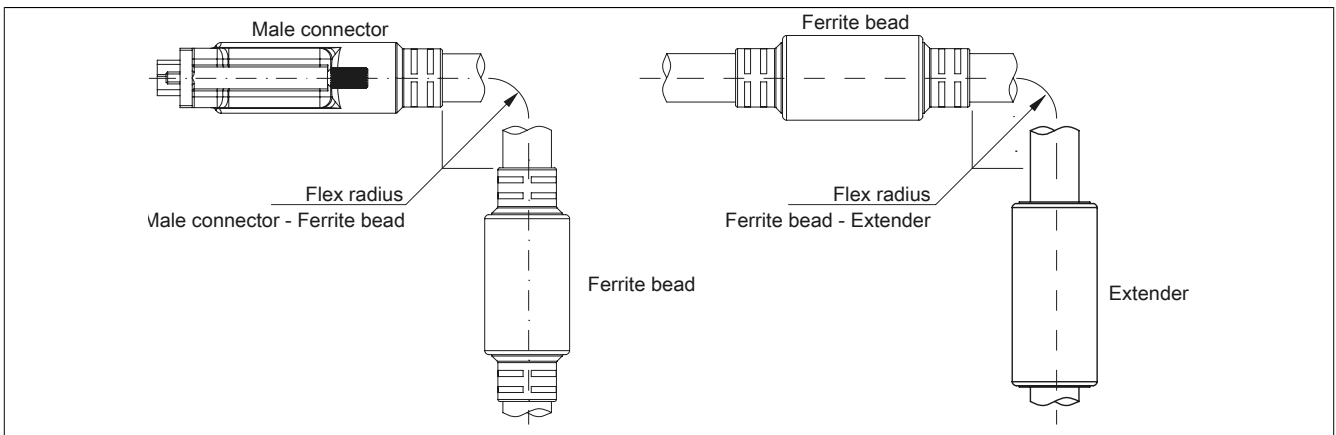

Figure 127: Flex radius specification with extender

4.5.1.5 Dimensions

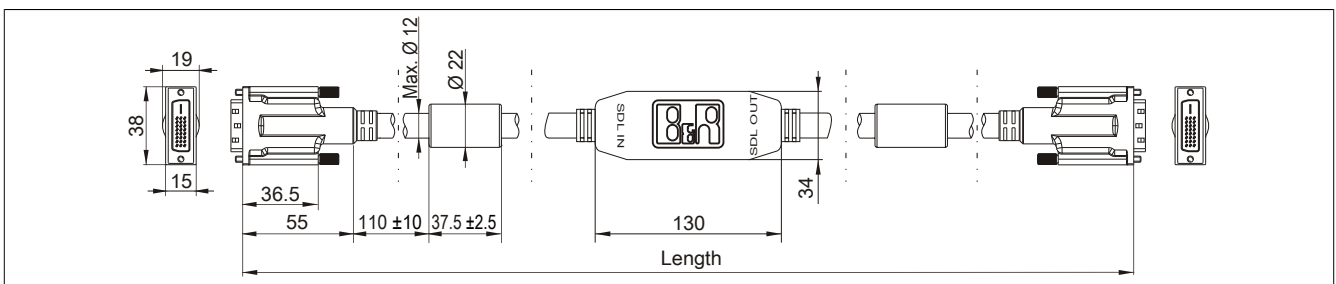

Figure 128: 5CASDL.0xx0-13 - Dimensions

4.5.1.6 Cable pinout

Warning!

Field-assembled cables must be wired according to these specifications.

If a field-assembled cable is used, B&R cannot guarantee that it will function properly. All cables provided by B&R are guaranteed to function properly, however.

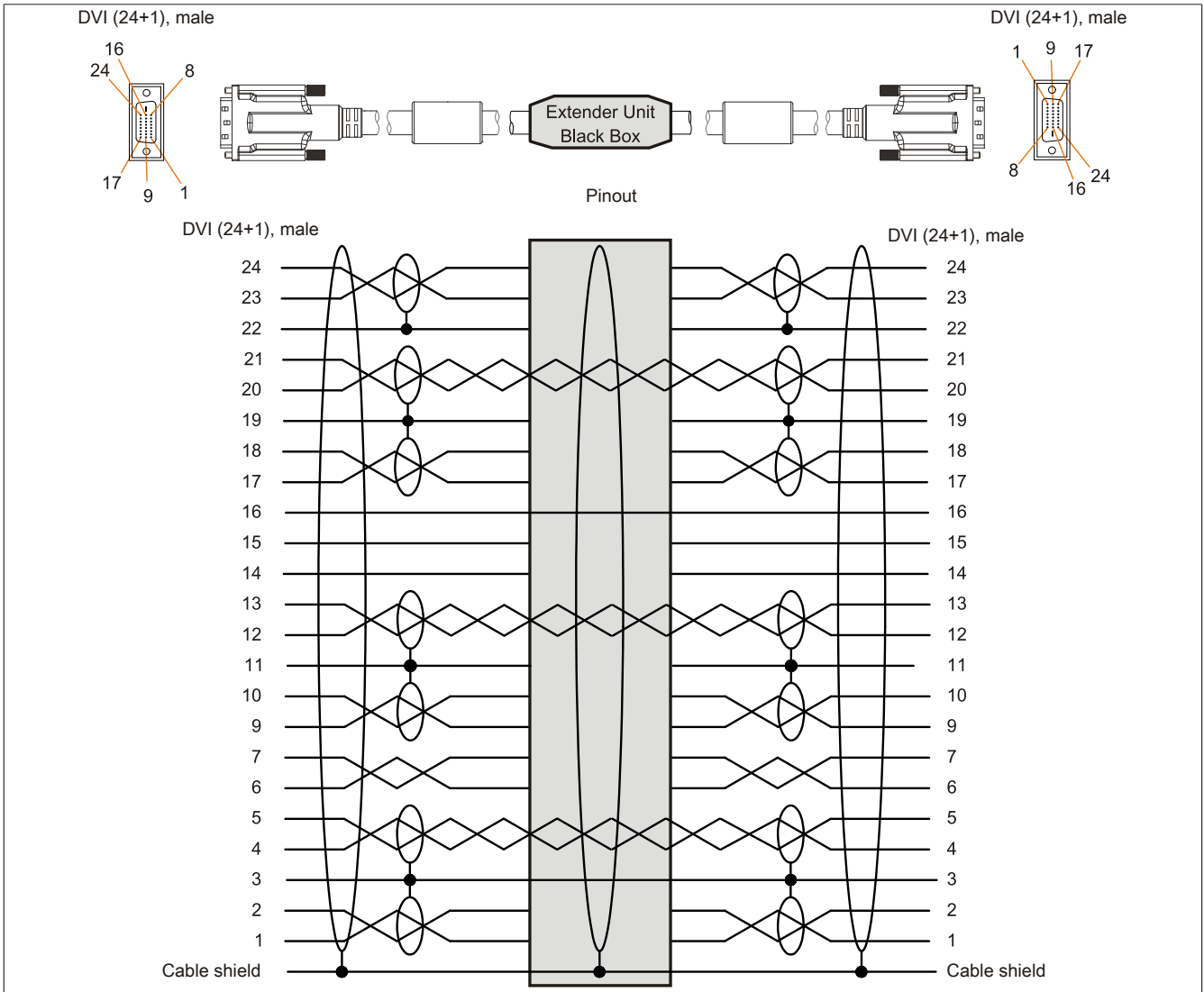

Figure 129: 5CASDL.0xx0-13 - Pinout

4.5.1.7 Cable connection

SDL flex cables with an extender must be connected between the B&R Industrial PC and the Automation Panel display unit in the correct direction. The proper signal direction is indicated on the extender.

- Connect the end labeled "SDL IN" with the video output of the APC910 (monitor/panel output) or Panel OUT of an AP900 AP Link card.
- Connect the "SDL OUT" end to the display unit (e.g. Automation Panel 900) via the Automation Panel Link plug-in card (Panel IN).

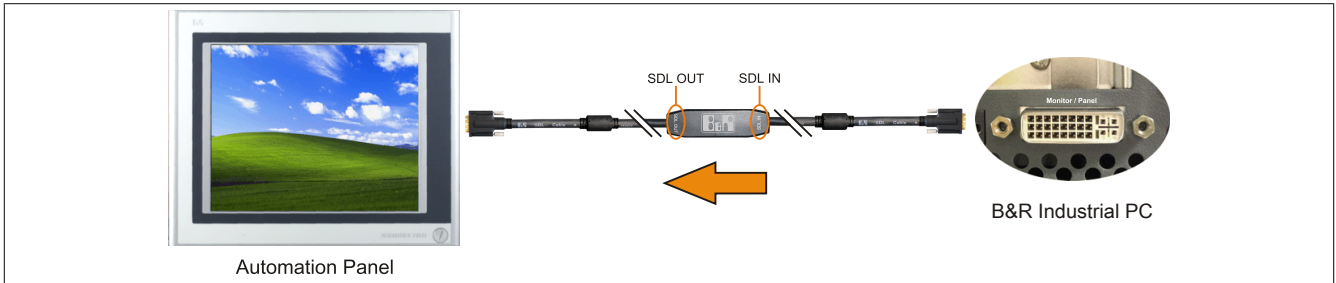

Figure 130: Example of the signal direction for an SDL flex cable with extender



Figure 131: Example of the signal direction for an SDL flex cable with extender

4.6 SDL3 cables

4.6.1 5CASD3.xxxx-00

4.6.1.1 General information

5CASD3.xxxx-00 SDL3 cables are designed to transfer SDL3 data and very easy to install. An RJ45 connector allows these cables to be connected in very narrow spaces, for example in swing arm shafts.

Caution!

Power must be disconnected before connecting or disconnecting cables.

4.6.1.2 Order data

Model number	Short description	Figure
	SDL3 cable	
5CASD3.0100-00	SDL3 cable, 10 m	
5CASD3.0150-00	SDL3 cable, 15 m	
5CASD3.0200-00	SDL3 cable, 20 m	
5CASD3.0300-00	SDL3 cable, 30 m	
5CASD3.0500-00	SDL3 cable, 50 m	
5CASD3.1000-00	SDL3 cable, 100 m	

Table 84: 5CASD3.0100-00, 5CASD3.0150-00, 5CASD3.0200-00, 5CASD3.0300-00, 5CASD3.0500-00, 5CASD3.1000-00 - Order data

4.6.1.3 Technical data

Product ID	5CASD3.0100-00	5CASD3.0150-00	5CASD3.0200-00	5CASD3.0300-00	5CASD3.0500-00	5CASD3.1000-00
General information						
Certification						
CE	Yes					
cULus	Yes					
Cable construction						
Wire cross section	4x 2x 26/7 AWG			4x 2x 23/1 AWG		
Features	Flame-resistant, halogen-free, lead-free					
Outer sheathing						
Material	Polyurethane (PUR)					
Color	Yellow, RAL 1021					
Labeling	HARTING INDUSTRIAL CABLE S/ FTP CAT 6A PUR 4x 2x 26/7 AWG			HARTING INDUSTRIAL INSTALLATION CABLE S/FTP CAT 7 PUR 4x 2x 23/1 AWG		
Lines						
Wire insulation	Polyethylene (PE)					
Wire colors	Green/white-green, orange/white-orange, blue/white-blue, brown/white-brown					
Shield	Aluminum foil and braided wire shield made of tinned copper wires					
Type	Unprotected copper wire, 4x 2x 26/7 AWG			Unprotected copper wire, 4x 2x 23/1 AWG		
Connector						
Type	2x RJ45, male					
Connection cycles	Min. 750					
Contacts	8					
Electrical characteristics ¹⁾						
Operating voltage	≤100 V			≤125 V		
Conductor resistance	≤290 Ω/km			≤75 Ω/km		
Wave impedance	100 ±5 Ω (at 100 MHz)					
Transfer properties	Category 6A / Class EA up to 500 MHz in accordance with ISO/IEC 11801 (EN 50173-1), ISO/IEC 24702 (EN 50173-3)			Category 7 / Class F up to 600 MHz in accordance with ISO/IEC 11801 (EN 50173-1), ISO/IEC 24702 (EN 50173-3)		
Insulation resistance	≥ 500 MΩ/km			≥5 GΩ/km		
Operating conditions						
Flame-retardant	IEC 60332-1-2					
Oil and hydrolysis resistance	EN 60811-2-1 (90°C / 7x24 h)					
EN 60529 protection						
Cables	IP20					
RJ45 connector	IP20, only when connected properly					
Environmental conditions						
Temperature						
Storage	-40 to 70°C					
Fixed installation	-40 to 70°C					
Flexible installation	-40 to 70°C			-10 to 50°C		

Table 85: 5CASD3.0100-00, 5CASD3.0150-00, 5CASD3.0200-00, 5CASD3.0300-00, 5CASD3.0500-00, 5CASD3.1000-00 - Technical data

Product ID	5CASD3.0100-00	5CASD3.0150-00	5CASD3.0200-00	5CASD3.0300-00	5CASD3.0500-00	5CASD3.1000-00
Mechanical characteristics						
Dimensions						
Length	10 m	15 m	20 m	30 m	50 m	100 m
Diameter	6.7 mm				8.3 mm	
Flex radius						
Fixed installation	≥5x diameter			≥4x diameter		
Flexible installation	≥10x diameter			≥8x diameter		
Weight	500 g	700 g	950 g	2150 g	3500 g	6950 g
Tension						
During operation	≤70 N			≤110 N		
During installation	≤70 N			≤110 N		

Table 85: 5CASD3.0100-00, 5CASD3.0150-00, 5CASD3.0200-00, 5CASD3.0300-00, 5CASD3.0500-00, 5CASD3.1000-00 - Technical data

1) At an ambient temperature of 20°C.

4.6.1.4 Flex radius specifications

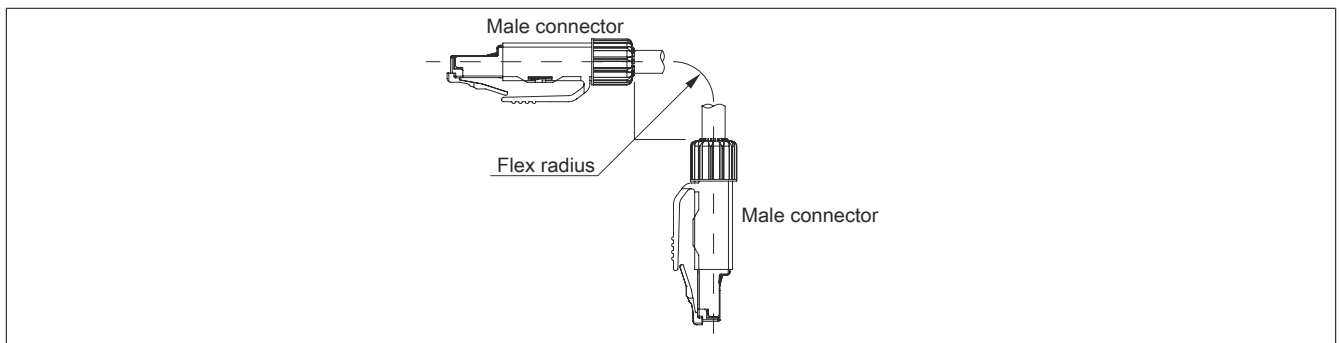

Figure 132: SDL3 - Flex radius specifications

4.6.1.5 Dimensions

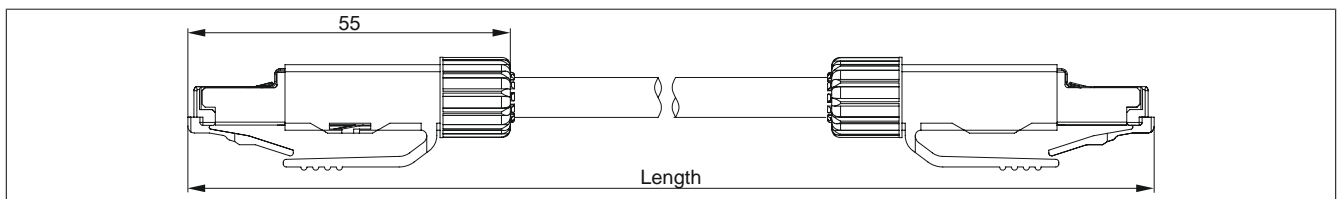

Figure 133: 5CASD3.xxxx-00 - Dimensions

4.6.1.6 Cable pinout

Warning!

Field-assembled cables must be wired according to these specifications.

If a field-assembled cable is used, B&R cannot guarantee that it will function properly. All cables provided by B&R are guaranteed to function properly, however.

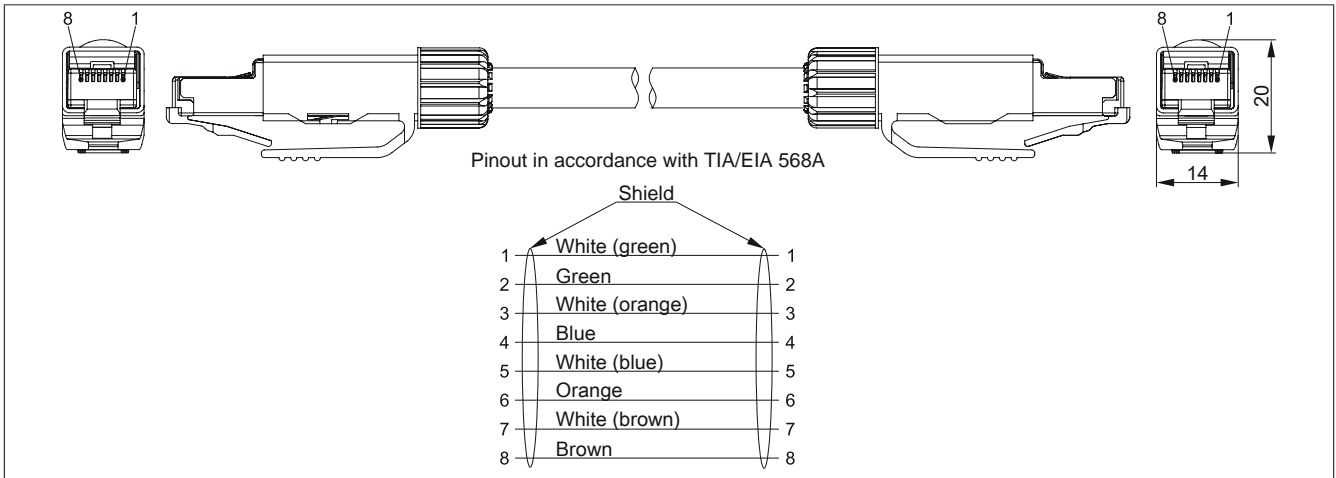

Figure 134: 5CASD3.xxxx-00 - Pinout

4.6.1.7 Cabling

The following information and figure apply when using a field-assembled cable that is not directly connected to a B&R device, but to an RJ45 network interface (e.g. patch panel).

Cables must meet category 6a (Cat6a) or category 7 (Cat7) requirements. Exceeding the maximum total length of 100 m is not permitted.

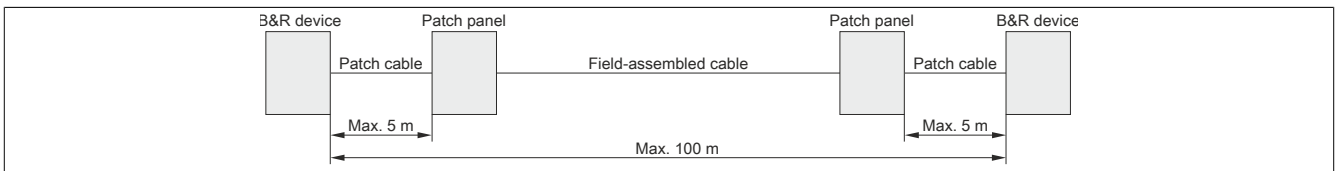

Figure 135: Cabling with a field-assembled cable

4.7 USB cables

4.7.1 5CAUSB.00xx-00

4.7.1.1 General information

USB cables are designed to achieve USB 2.0 transfer speeds.

4.7.1.2 Order data

Model number	Short description	Figure
	USB cables	
5CAUSB.0018-00	USB 2.0 connection cable type A - type B, 1.8 m	
5CAUSB.0050-00	USB 2.0 connection cable type A - type B, 5 m	

Table 86: 5CAUSB.0018-00, 5CAUSB.0050-00 - Order data

4.7.1.3 Technical data

Product ID	5CAUSB.0018-00	5CAUSB.0050-00
General information		
Certification		
CE		Yes
cULus		Yes
GOST-R		Yes
Cable construction		
Wire cross section		AWG 24, 28
Shield		Entire cable
Outer sheathing		
Color		Beige
Connector		
Type	USB type A male and USB type B male	
Mechanical characteristics		
Dimensions		
Length	1.8 m ±30 mm	5 m ±50 mm
Diameter		Max. 5 mm
Flex radius		Min. 100 mm

Table 87: 5CAUSB.0018-00, 5CAUSB.0050-00 - Technical data

4.7.1.4 Cable pinout

Warning!

Field-assembled cables must be wired according to these specifications.

If a field-assembled cable is used, B&R cannot guarantee that it will function properly. All cables provided by B&R are guaranteed to function properly, however.

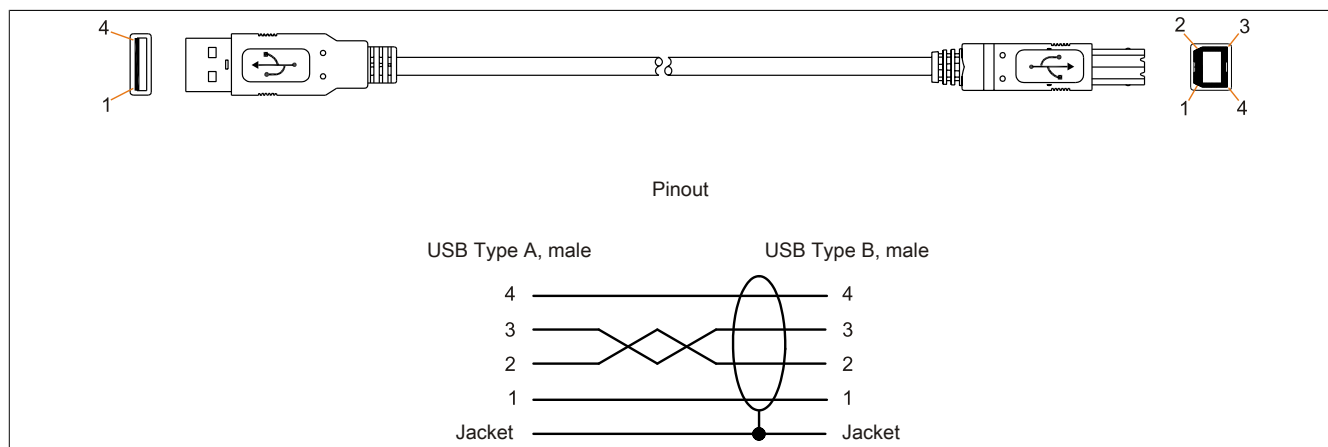

Figure 136: 5CAUSB.00xx-00 USB cables - Pinout

4.8 RS232 cables

4.8.1 9A0014.xx

4.8.1.1 General information

RS232 cables are used as extension cables between two RS232 interfaces.

4.8.1.2 Order data

Model number	Short description	Figure
	RS232 cables	
9A0014.02	RS232 extension cable for remote operation of a display unit with touch screen, 1.8 m	
9A0014.05	RS232 extension cable for remote operation of a display unit with touch screen, 5 m	
9A0014.10	RS232 extension cable for remote operation of a display unit with touch screen, 10 m	

Table 88: 9A0014.02, 9A0014.05, 9A0014.10 - Order data

4.8.1.3 Technical data

Product ID	9A0014.02	9A0014.05	9A0014.10
General information			
Certification		Yes	Yes
CE			
GOST-R	-		
Cable construction			
Wire cross section		AWG 26	
Shield		Entire cable	
Outer sheathing			
Color		Beige	
Connector			
Type		9-pin male/female DSUB connector	
Locating screw tightening torque		Max. 0.5 Nm	
Mechanical characteristics			
Dimensions			
Length	1.8 m ±50 mm	5 m ±80 mm	10 m ±100 mm
Diameter		Max. 5 mm	
Flex radius		Min. 70 mm	

Table 89: 9A0014.02, 9A0014.05, 9A0014.10 - Technical data

4.8.1.4 Cable pinout

Warning!

Field-assembled cables must be wired according to these specifications.

If a field-assembled cable is used, B&R cannot guarantee that it will function properly. All cables provided by B&R are guaranteed to function properly, however.

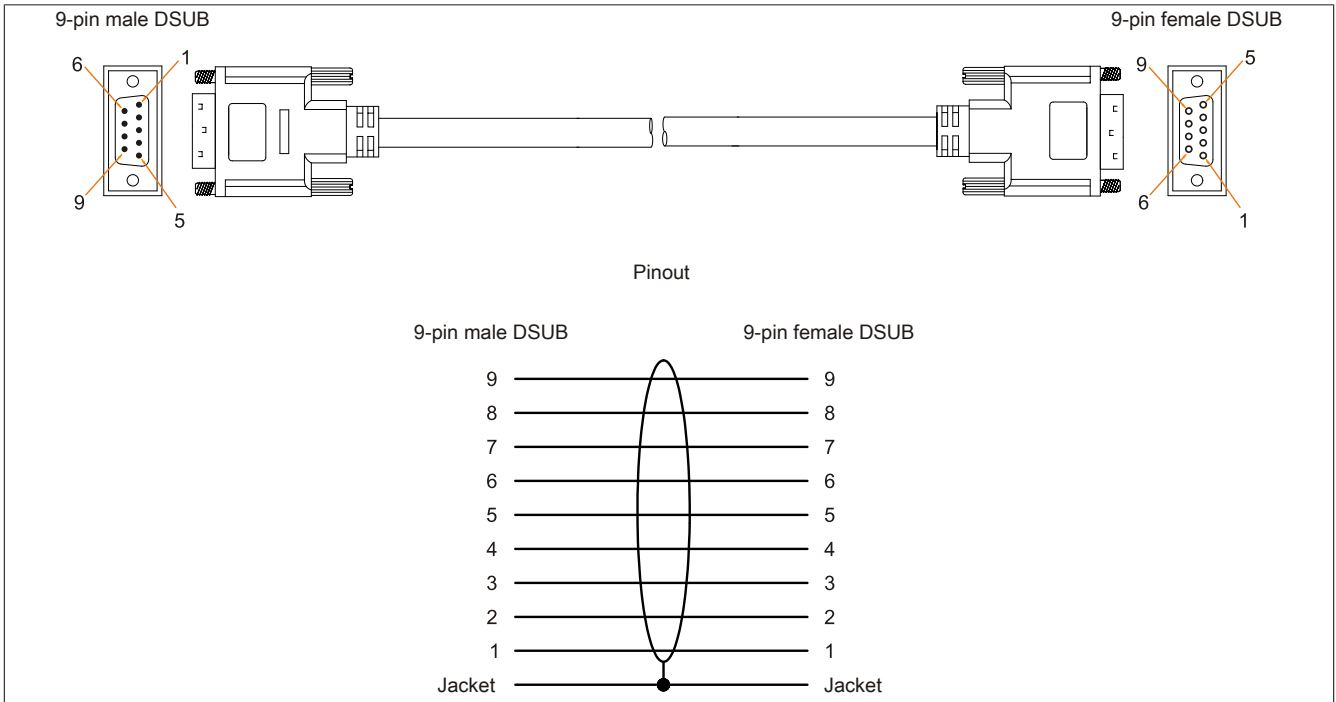

Figure 137: 9A0014.xx RS232 cables - Pinout

5 USB interface cover

5.1 5AC900.1200-00

5.1.1 General information

Round front-side USB interface cover (with anti-loss strap) for Automation Panel 900 and Panel PC 700 devices.

5.1.2 Order data

Model number	Short description	Figure
	Accessories	
5AC900.1200-00	USB Cover non-detachable; for Automation Panel and Panel PC.	

Table 90: 5AC900.1200-00 - Order data

5.2 5AC900.1200-01

5.2.1 General information

Flat front-side USB interface cover for Automation Panel 900 and Panel PC 700 devices.

5.2.2 Order data

Model number	Short description	Figure
	Accessories	
5AC900.1200-01	USB interface cover - Flat - For AP920/98x and PPC700	

Table 91: 5AC900.1200-01 - Order data

5.3 5AC900.1201-00

5.3.1 General information

Flat front-side USB interface cover for Automation Panel 900, Power Panel 500, Panel PC 700 and Panel PC 800 devices.

5.3.2 Order data

Model number	Short description	Figure
	Accessories	
5AC900.1201-00	USB interface cover M20 IP65 flat	

Table 92: 5AC900.1201-00 - Order data

5.4 5AC900.1201-01

5.4.1 General information

Round front-side knurled USB interface cover (with anti-loss strap) for Automation Panel 900, Power Panel 500, Panel PC 700 and Panel PC 800 devices.

5.4.2 Order data

Model number	Short description	Figure
5AC900.1201-01	Accessories	
	USB interface cover M20 IP65 curved	

Table 93: 5AC900.1201-01 - Order data

6 USB flash drives

6.1 5MMUSB.2048-00

6.1.1 General information

USB flash drives are storage media that are easy to exchange. Because of their fast data transfer (USB 2.0), USB flash drives are ideal for use as portable data storage. Without requiring additional drivers ("hot plugging", except in the case of Windows 98SE), the USB flash drive can immediately act as an additional drive for reading or writing data.

Information:

Due to the vast quantity of USB flash drives available on the market as well as their short product life cycle, we reserve the right to supply alternative products at any time. The following measures may therefore be necessary in order to boot from these flash drives as well:

- The flash drive must be reformatted or in some cases even repartitioned (set active partition).
- The flash drive must be the first bootable device in the BIOS boot order; alternatively, the IDE controllers can be disabled in BIOS. This can be avoided in most cases if the "fdisk /mbr" command is additionally executed on the USB flash drive.

6.1.2 Order data

Model number	Short description	Figure
	USB accessories	
5MMUSB.2048-00	USB 2.0 flash drive, 2048 MB	

Table 94: 5MMUSB.2048-00 - Order data

6.1.3 Technical data

Information:

The following characteristics, features and limit values only apply to this accessory and can deviate from those specified for the complete system. The data specifications for the complete system take precedence over those of individual components.

Product ID	5MMUSB.2048-00
General information	
Data retention	10 years
LEDs	1 LED (green) ¹⁾
MTBF	100,000 hours (at 25°C)
Type	USB 1.1, USB 2.0
Maintenance	None
Certification CE	Yes
Interfaces	
USB	
Type	USB 1.1, USB 2.0
Connection	To any USB type A interface
Transfer rate	Low speed (1.5 Mbit/s), full speed (12 Mbit/s), high speed (480 Mbit/s)
Sequential reading	Max. 8.7 MB/s
Sequential writing	Max. 1.7 MB/s
Support	
Operating systems	
Windows XP Professional	Yes
Windows XP Embedded	Yes
Windows ME	Yes
Windows 2000	Yes
Windows CE 5.0	Yes
Windows CE 4.2	Yes
Electrical characteristics	
Power consumption	650 µA sleep mode, 150 mA read/write

Table 95: 5MMUSB.2048-00 - Technical data

Product ID	5MMUSB.2048-00
Environmental conditions	
Temperature	
Operation	0 to 45°C
Storage	-20 to 60°C
Transport	-20 to 60°C
Relative humidity	
Operation	10 to 90%, non-condensing
Storage	5 to 90%, non-condensing
Transport	5 to 90%, non-condensing
Vibration	
Operation	10 to 500 Hz: 2 g (19.6 m/s ² 0-peak), oscillation rate 1/minute
Storage	10 to 500 Hz: 2 g (19.6 m/s ² 0-peak), oscillation rate 1/minute
Transport	10 to 500 Hz: 2 g (19.6 m/s ² 0-peak), oscillation rate 1/minute
Shock	
Operation	Max. 40 g (392 m/s ² 0-peak) and 11 ms duration
Storage	Max. 80 g (784 m/s ² 0-peak) and 11 ms duration
Transport	Max. 80 g (784 m/s ² 0-peak) and 11 ms duration
Altitude	
Operation	Max. 3048 m
Storage	Max. 12192 m
Transport	Max. 12192 m
Mechanical characteristics	
Dimensions	
Width	19 mm
Length	52.2 mm
Height	7.9 mm

Table 95: 5MMUSB.2048-00 - Technical data

1) Indicates data being transferred (sending and receiving).

6.1.4 Temperature/Humidity diagram

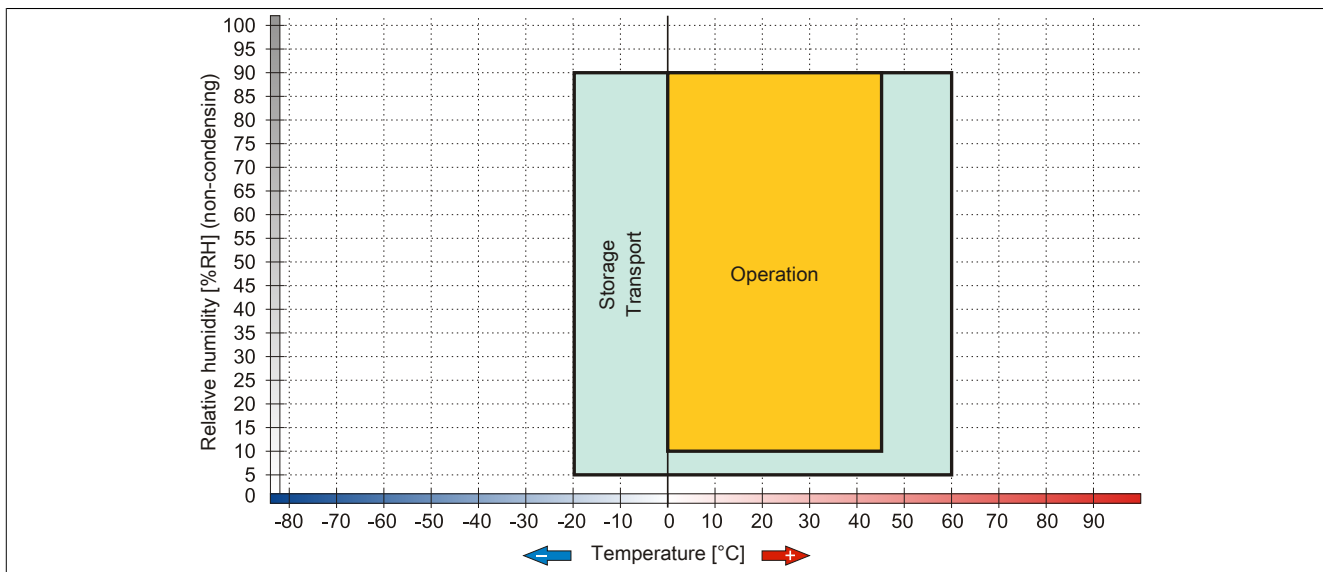

Figure 138: 5MMUSB.2048-00 - Temperature/Humidity diagram

6.2 5MMUSB.xxxx-01

6.2.1 General information

USB flash drives are storage media that are easy to exchange. Because of their fast data transfer (USB 2.0), USB flash drives are ideal for use as portable data storage. Without requiring additional drivers ("hot plugging", except in the case of Windows 98SE), the USB flash drive can immediately act as an additional drive for reading or writing data.

Information:

Due to the vast quantity of USB flash drives available on the market as well as their short product life cycle, we reserve the right to supply alternative products at any time. The following measures may therefore be necessary in order to boot from these flash drives as well:

- The flash drive must be reformatted or in some cases even repartitioned (set active partition).
- The flash drive must be the first bootable device in the BIOS boot order; alternatively, the IDE controllers can be disabled in BIOS. This can be avoided in most cases if the "fdisk /mbr" command is additionally executed on the USB flash drive.

6.2.2 Order data

Model number	Short description	Figure
	USB accessories	
5MMUSB.2048-01	USB 2.0 flash drive, 2048 MB, B&R	
5MMUSB.4096-01	USB 2.0 flash drive, 4096 MB, B&R	

Table 96: 5MMUSB.2048-01, 5MMUSB.4096-01 - Order data

6.2.3 Technical data

Product ID	5MMUSB.2048-01	5MMUSB.4096-01
General information		
Capacity	2 GB	4 GB
LEDs	1 LED (green) ¹⁾	
MTBF	>3,000,000 hours	
Type	USB 1.1, USB 2.0	
Maintenance	None	
Default file system	FAT16	FAT32
Certification		
CE	Yes	
GOST-R	Yes	
Interfaces		
USB		
Type	USB 1.1, USB 2.0	
Connection	To any USB type A interface	
Transfer rate	Low speed (1.5 Mbit/s), full speed (12 Mbit/s), high speed (480 Mbit/s)	
Sequential reading	Full speed max. 1 MB/s, High speed max. 32 MB/s	
Sequential writing	Full speed max. 0.9 MB/s, High speed max. 23 MB/s	
Endurance		
SLC flash	Yes	
Data retention	>10 years	
Data reliability	<1 unrecoverable error in 10 ¹⁴ bit read accesses	
Connection cycles	>1,500	
Support		
Operating systems		
Windows 7	Yes	
Windows XP Professional	Yes	
Windows XP Embedded	Yes	
Windows ME	Yes	
Windows 2000	Yes	
Windows CE 5.0	Yes	
Windows CE 4.2	Yes	
Electrical characteristics		
Current consumption	Max. 500 µA sleep mode, max. 120 mA read/write	

Table 97: 5MMUSB.2048-01, 5MMUSB.4096-01 - Technical data

Product ID	5MMUSB.2048-01	5MMUSB.4096-01
Environmental conditions		
Temperature		
Operation	0 to 70°C	
Storage	-50 to 100°C	
Transport	-50 to 100°C	
Relative humidity		
Operation	85%, non-condensing	
Storage	85%, non-condensing	
Transport	85%, non-condensing	
Vibration		
Operation	20 to 2000 Hz: 20 g (peak)	
Storage	20 to 2000 Hz: 20 g (peak)	
Transport	20 to 2000 Hz: 20 g (peak)	
Shock		
Operation	Max. 1500 g (peak)	
Storage	Max. 1500 g (peak)	
Transport	Max. 1500 g (peak)	
Altitude		
Operation	Max. 3048 m	
Storage	Max. 12192 m	
Transport	Max. 12192 m	
Mechanical characteristics		
Dimensions		
Width	17.97 mm	
Length	67.85 mm	
Height	8.35 mm	

Table 97: 5MMUSB.2048-01, 5MMUSB.4096-01 - Technical data

1) Indicates data being transferred (sending and receiving).

6.2.4 Temperature/Humidity diagram

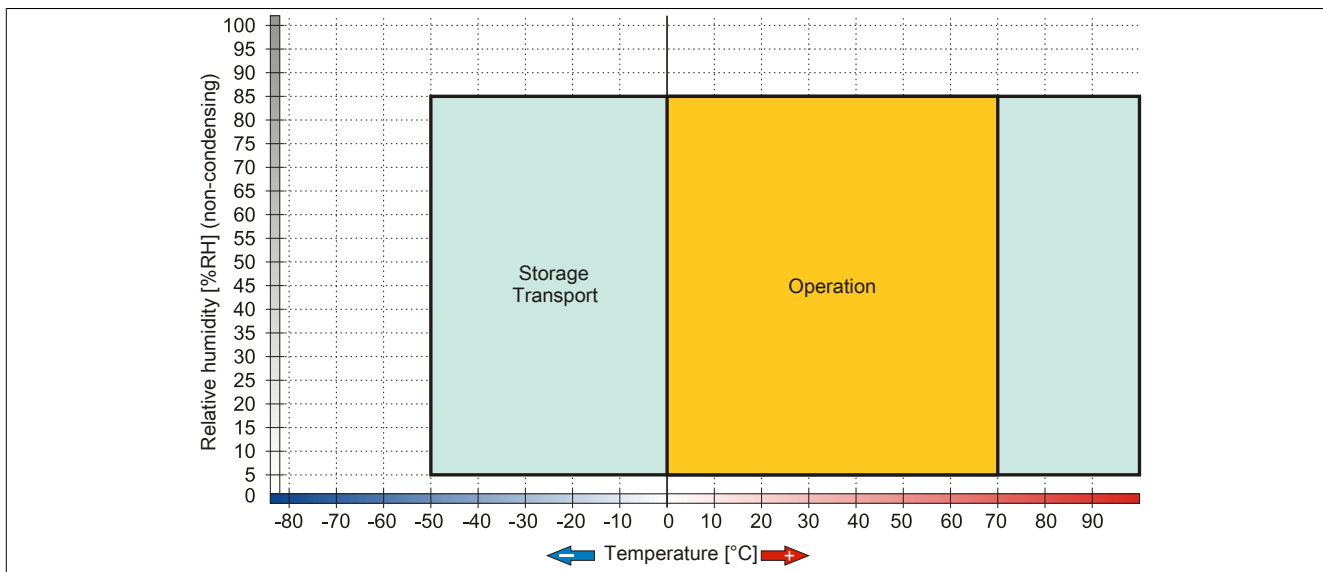

Figure 139: 5MMUSB.xxxx-01 - Temperature/Humidity diagram

7 AP900 fluorescent tubes

7.1 General information

The fluorescent tubes in TFT displays are subject to wear. They must therefore be replaced after several years depending on the number of operating hours (see 2 "Technical data" on page 17).

Fluorescent tubes can only be replaced on 12.1" and 15" Automation Panel 900 devices.

Information:

They cannot be replaced on 10.4", 17", 19" and 21.3" Automation Panel 900 devices!

The following table lists the fluorescent tubes that can be used for each panel.

Fluorescent tube	Panel	Starting with Rev.
9A0110.18 (for 12.1" devices)	5AP920.1214-01	
	5PC720.1214-00	
	5PC720.1214-01	
	5PP120.1214-37	
	5PP120.1214-37A	
	5PP320.1214-39	
9A0110.22 (for 15" devices)	4PP320.1505-31, 4PP420.1505-75, 4PP420.1505-B5, 4PP480.1505-75, 4PP480.1505-B5, 4PP481.1505-75, 5AP820.1505-00, 5AP880.1505-00, 5AP920.1505-01, 5AP951.1505-01, 5AP980.1505-01, 5AP981.1505-01, 5PC720.1505-00, 5PC720.1505-01, 5PC720.1505-02, 5PC781.1505-00, 5PP320.1505-39	A0
	4PP151.1505-31, 4PP181.1505-31, 5PP120.1505-37A	H0
	4PP251.1505-75, 4PP251.1505-B5, 4PP280.1505-75, 4PP280.1505-B5, 4PP281.1505-75, 4PP281.1505-B5, 4PP180.1505-31	I0
	4PP120.1505-31	S0
	4PP220.1505-75	V0
	4PP220.1505-B5	W0

Table 98: Overview of fluorescents tubes and panels

7.2 Order data

Model number	Short description	Figure
	Accessories	
9A0110.18	Backlight (spare part) for panels with Sharp LQ121S1DG41: 5AP920.1214-01 5PC720.1214-00 5PC720.1214-01 5PP120.1214-37 5PP120.1214-37A 5PP320.1214-39	Image not found for 9A0110.18!
9A0110.22	Backlight (spare part) for panels with Sharp LQ150X1LW71N: 4PP120.1505-31 From revision S0 4PP151.1505-31 From revision H0 4PP180.1505-31 From revision I0 4PP181.1505-31 From revision H0 4PP220.1505-75 From revision V0 4PP220.1505-B5 From revision W0 4PP251.1505-75 From revision I0 4PP251.1505-B5 From revision I0 4PP280.1505-75 From revision I0 4PP280.1505-B5 From revision I0 4PP281.1505-75 From revision I0 4PP281.1505-B5 From revision I0 4PP320.1505-31 From revision A0 4PP420.1505-75 From revision A0 4PP420.1505-B5 From revision A0 4PP480.1505-75 From revision A0 4PP480.1505-B5 From revision A0 4PP481.1505-75 From revision A0 5AP820.1505-00 From revision A0 5AP880.1505-00 From revision A0 5AP920.1505-01 From revision A0 5AP951.1505-01 From revision A0 5AP980.1505-01 From revision A0 5AP981.1505-01 From revision A0 5PC720.1505-00 From revision A0 5PC720.1505-01 From revision A0 5PC720.1505-02 From revision A0 5PC781.1505-00 From revision A0 5PP120.1505-37A From revision H0 5PP320.1505-39 From revision A0	

Table 99: 9A0110.18, 9A0110.22 - Order data

8 Line filter

8.1 5AC804.MFLT-00

8.1.1 General information

The 5AC804.MFLT-00 line filter may be necessary to satisfy requirements regarding conducted disturbances in supply lines in accordance with the 2003 edition of GL EMC1 (Germanischer Lloyd).

The line filter should be installed as close to the end device as possible; the supply line from the end device to the line filter should be kept as short as possible.

8.1.2 Order data

Model number	Short description	Figure
5AC804.MFLT-00	Line filter	

Table 100: 5AC804.MFLT-00 - Order data

8.1.3 Technical data

Information:

The following characteristics, features and limit values only apply to this accessory and can deviate from those specified for the complete system. The data specifications for the complete system take precedence over those of individual components.

Product ID	5AC804.MFLT-00
General information	
Certification	
CE	Yes
cULus	Yes
cULus HazLoc Class 1 Division 2	Yes ¹⁾
GOST-R	Yes
GL	Yes ¹⁾
Terminal block	
Connection cross section	
With wire end sleeves	1.5 mm ²
Flexible	0.2 to 1.5 mm ²
Inflexible	0.2 to 2.5 mm ²
Electrical characteristics	
Nominal voltage	24 VDC -25% / +30%
Nominal current	8 A
Environmental conditions	
Temperature	
Operation	-25 to 65°C
Storage	-25 to 65°C
Transport	-25 to 65°C
Mechanical characteristics	
Housing	
Materials	Galvanized steel plate
Dimensions	
Width	54 mm
Length	94 mm
Depth	32.15 mm
Weight	205 g

Table 101: 5AC804.MFLT-00 - Technical data

1) Yes, although applies only if all components installed within the complete system have this certification

8.1.4 Dimensions

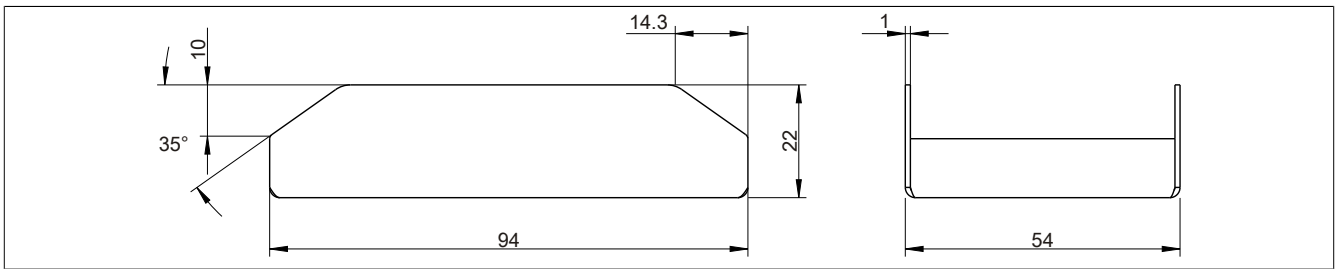

Figure 140: 5AC804.MFLT-00 - Dimensions

8.1.5 Drilling template

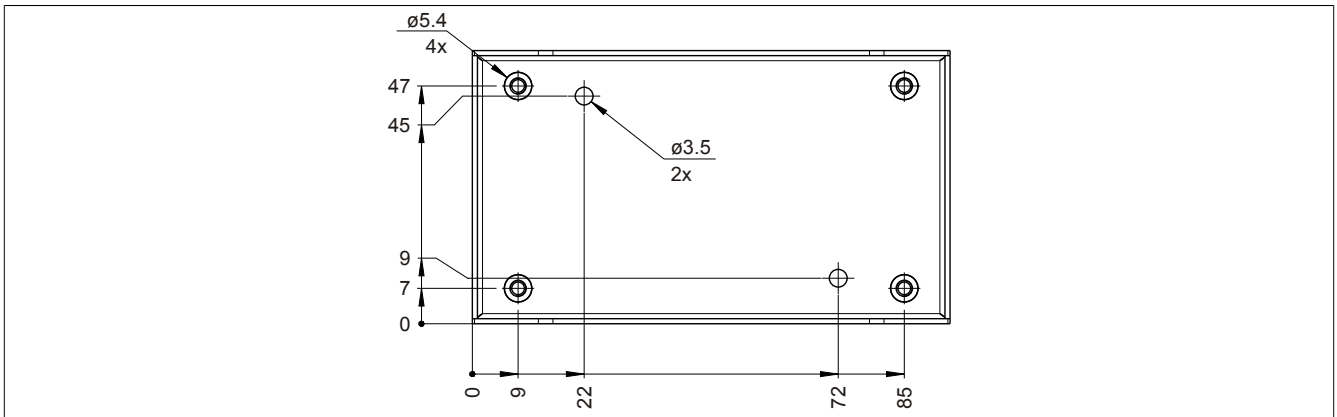

Figure 141: 5AC804.MFLT-00 - Drilling template

8.1.6 Connecting to the end device

The line filter must be connected between the supply voltage and the end device.

The following points must be observed:

- Use shielded, twisted wires.
- Keep the lines as short as possible (supply voltage - line filter - end device).
- The line filter must be installed on an unpainted, oil-free metallic surface.

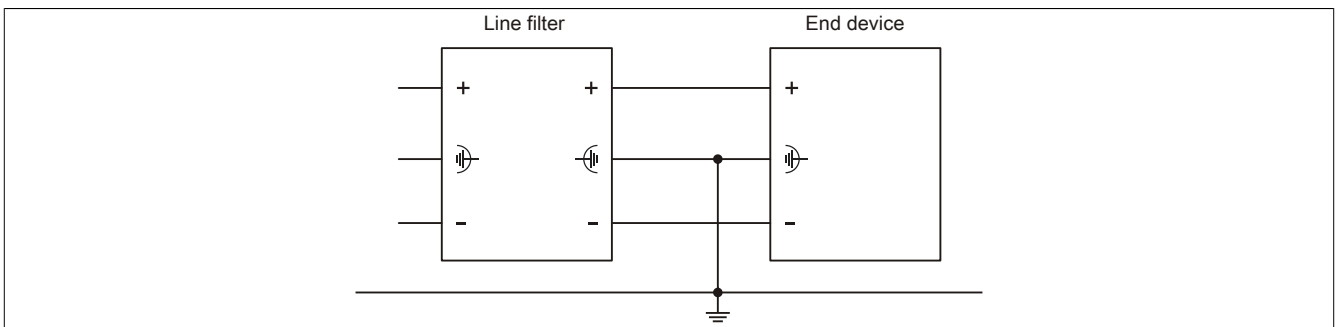

Figure 142: Connection example

9 HMI Drivers & Utilities DVD

9.1 5SWHMI.0000-00

9.1.1 General information

This DVD contains drivers, utilities, software upgrades and user's manuals for B&R panel system products (see the "Industrial PCs" or "Visualization and operation" section of the B&R website at www.br-automation.com).

When the DVD is created, its contents are identical to the files found in the Downloads section of the B&R website (Service / Material-related downloads).

9.1.2 Order data

Model number	Short description	Figure
5SWHMI.0000-00	<p>Other</p> <p>HMI Drivers & Utilities DVD</p>	

Table 102: 5SWHMI.0000-00 - Order data

9.1.3 Contents (V2.20)

BIOS product upgrades

- Automation PC 620 / Panel PC 700 CPU board 815E and 855GME BIOS
- Automation PC 620 / Panel PC 700 CPU board X855GME BIOS
- Automation PC 620 / Panel PC 700 CPU board 945GME BIOS
- Automation PC 620 / Panel PC 700 CPU board 945GME N270 BIOS
- Automation PC 680
- Automation PC 810 / Automation PC 820 / Panel PC 800 B945GME BIOS
- Automation PC 810 / Panel PC 800 945GME N270 CPU board BIOS
- Automation PC 810 / Panel PC 800 GM45 CPU board BIOS
- Provit 2000 product family - IPC2000/2001/2002
- Provit 5000 product family - IPC5000/5600/5000C/5600C
- Power Panel 100 BIOS devices
- Mobile Panel 100 BIOS devices
- Power Panel 100 / Mobile Panel 100 user boot logo
- Power Panel 100 / Mobile Panel 100 REMHOST utility
- Power Panel 300/400 BIOS devices
- Power Panel 300/400 BIOS user boot logo
- Power Panel 500 / Automation PC 510 / Automation PC 511 BIOS
- Panel PC 310

Device drivers

- Automation Device Interface (ADI)
- Audio
- Chipset
- CD-ROM
- LS120

- Graphics
- Network
- PCI / SATA RAID controller
- Touch screen
- Touchpad
- Interface board

Firmware upgrades

- Automation PC 620 / Panel PC 700 (MTCX, SDLR, SDLT)
- Automation PC 810 (MTCX, SDLR, SDLT)
- Automation PC 820 (MTCX, SDLR, SDLT)
- Mobile Panel 100 (SMCX)
- Panel PC 300 (MTCX)
- Power Panel 100 (aPCI)
- Power Panel 300/400 (aPCI)
- Power Panel 300/400 (MTCX)
- Power Panel 500 / Automation PC 510 / Automation PC 511 (MTCX, SDLR, I/O board)
- Panel PC 800 (MTCX, SDLR, SDLT)
- UPS firmware

Utilities/Tools

- B&R Embedded OS Installer
- Windows CE Tools
- User boot logo conversion program
- SATA RAID Installation Utility
- Automation Device Interface (ADI)
- CompactFlash service life calculator (Silicon Systems)
- Miscellaneous
- MTC utilities
- B&R Key Editor
- MTC & Mkey utilities
- Mkey utilities
- UPS configuration software
- ICU ISA configuration
- Intel PCI NIC boot ROM
- Diagnostic programs

Windows

- Windows CE 6.0
- Windows CE 5.0
- Windows CE 4.2
- Windows CE 4.1
- Windows CE Tools
- Windows Embedded Standard 2009
- Windows Embedded Standard 7
- Thin client
- Windows NT Embedded
- Windows XP Embedded
- VNC viewer

MCAD templates for

- Industrial PCs

- Visualization and operating devices
- Slide-in label templates
- Custom designs

ECAD templates for

- Industrial PCs
- Automation PCs
- Automation Panel 900
- Panels (Power Panel)

Documentation for

- Automation PC 511
- Automation PC 620
- Automation PC 680
- Automation PC 810
- Automation PC 820
- Automation Panel 800
- Automation Panel 900
- Panel PC 310
- Panel PC 700
- Panel PC 725
- Panel PC 800
- Power Panel 15/21/35/41
- Power Panel 100/200
- Power Panel 300/400
- Power Panel 500
- Mobile Panel 40/50
- Mobile Panel 100/200
- Mobile Panel connection box
- Provit 2000
- Provit 3030
- Provit 4000
- Provit 5000
- Provit Benchmark
- Provit Mkey
- Windows CE 5.0 help documentation
- Windows CE 6.0 help documentation
- Windows NT Embedded application guide
- Windows XP Embedded application guide
- Uninterruptible power supply
- Implementation guides
- B&R Hilscher fieldbus cards (CANopen, DeviceNet, PROFIBUS, PROFINET)

Service tools

- Acrobat Reader 5.0.5 (freeware in German, English and French)
- Power Archiver 6.0 (freeware in German, English and French)
- Internet Explorer 5.0 (German and English)
- Internet Explorer 6.0 (German and English)

Chapter 7 • Maintenance and service

This chapter describes service/maintenance work that can be carried out by a qualified end user.

1 Cleaning

Danger!

This device can only be cleaned when switched off in order to prevent unintended functions from being triggered when handling the touch screen or pressing keys.

This device should be cleaned with a moist cloth. The cloth should be moistened with water and detergent, a screen cleaning agent or alcohol (ethanol). The cleaning agent should be applied to the cloth beforehand, not sprayed directly on the device! Aggressive solvents, chemicals, scouring agents, pressurized air or steam jets should never be used.

Information:

Displays with a touch screen should be cleaned regularly.

2 Replacing the fluorescent tubes

Danger!

Fluorescent tubes may only be replaced by qualified personnel when the Automation Panel 900 device and the entire system are both switched off.

2.1 Procedure

First step for all units (12.1" and 15"): Remove the cover. Remove the locating screws (1) and insert the card (2). Unscrew the screws on the cover (using a size 10 Torx screwdriver) and remove the cover (3).

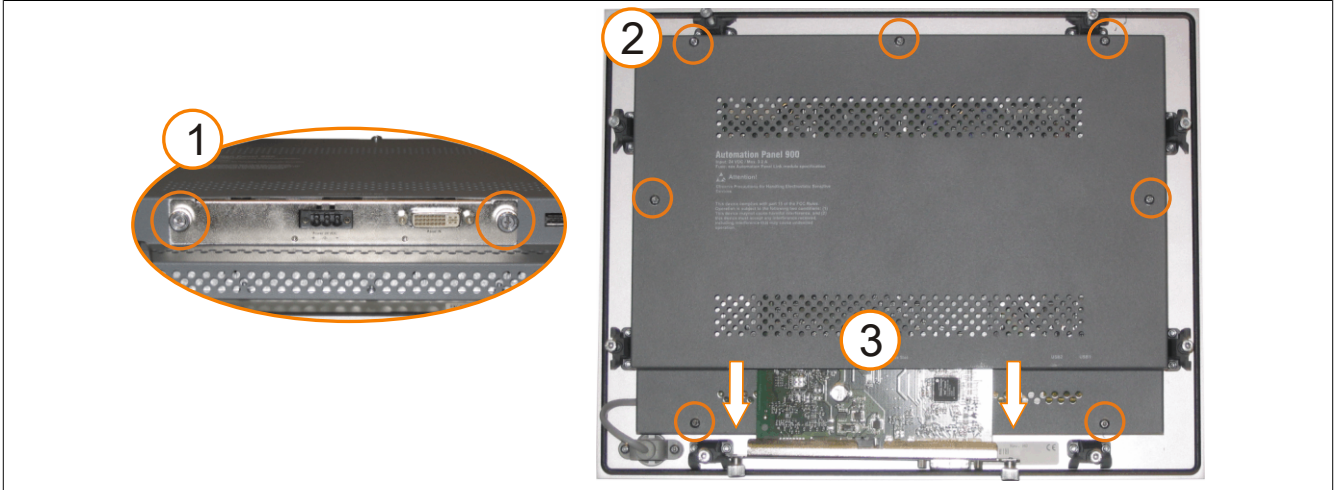

Figure 143: Removing the cover

2.1.1 General information

Warning!

To avoid damaging the fluorescent tubes during replacement, they should be removed by grasping the white plate (12.1" and 15" devices) using small flat-nose pliers. Do not pull on the cables since this can break the tubes.

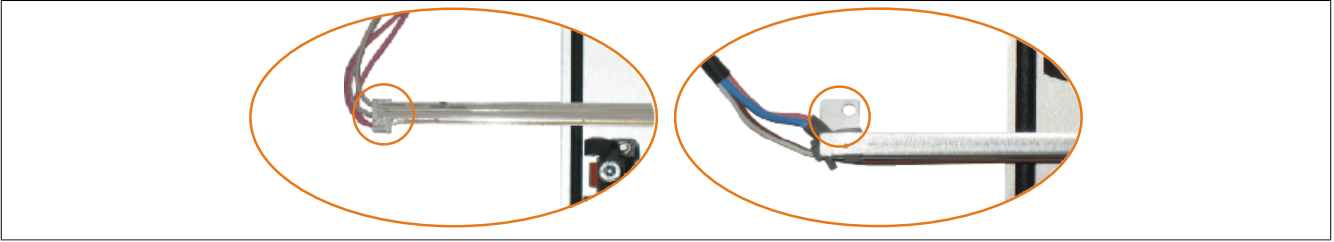

Figure 144: Warning - Replacing the fluorescent tubes

2.1.2 Procedure for 12.1" Automation Panels

- Using a small Phillips screwdriver, remove the screws and disconnect the fluorescent tube.

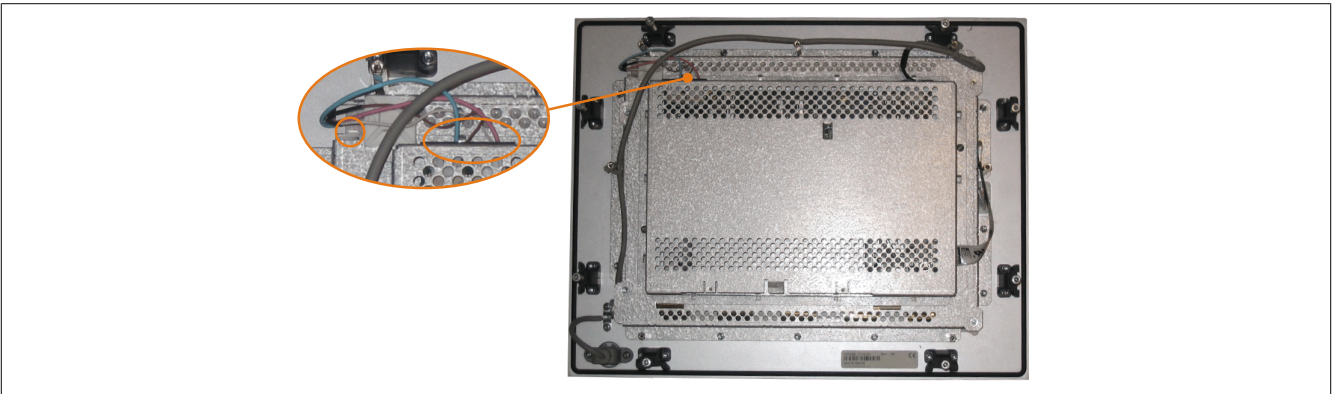

Figure 145: 12.1" Automation Panels - Unscrewing and disconnecting

- Replace the fluorescent tube. To do this, carefully pull the tube out of its holder and replace it with a new one.

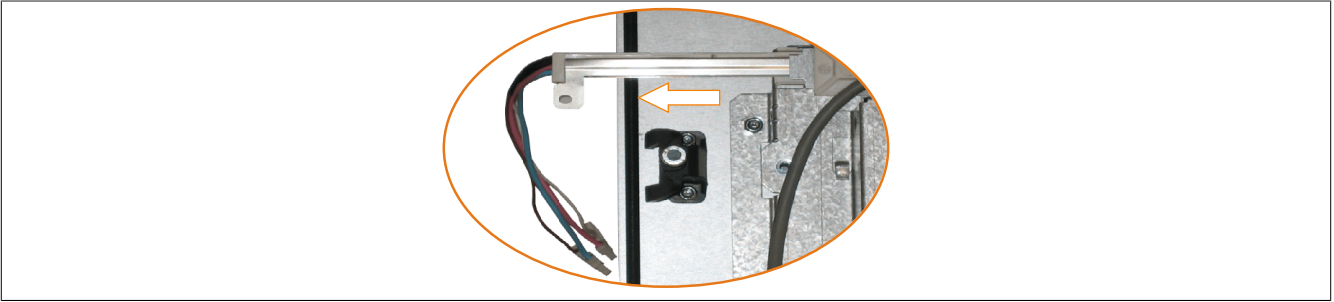

Figure 146: 12.1" Automation Panels - Replacing the fluorescent tube

2.1.3 Procedure for 15" Automation Panels

- Unplug the fluorescent tube (1). Remove the screws (2) from the fluorescent tubes using a small Phillips screwdriver, and remove the ground (3) from the housing using a size 10 Torx screwdriver.

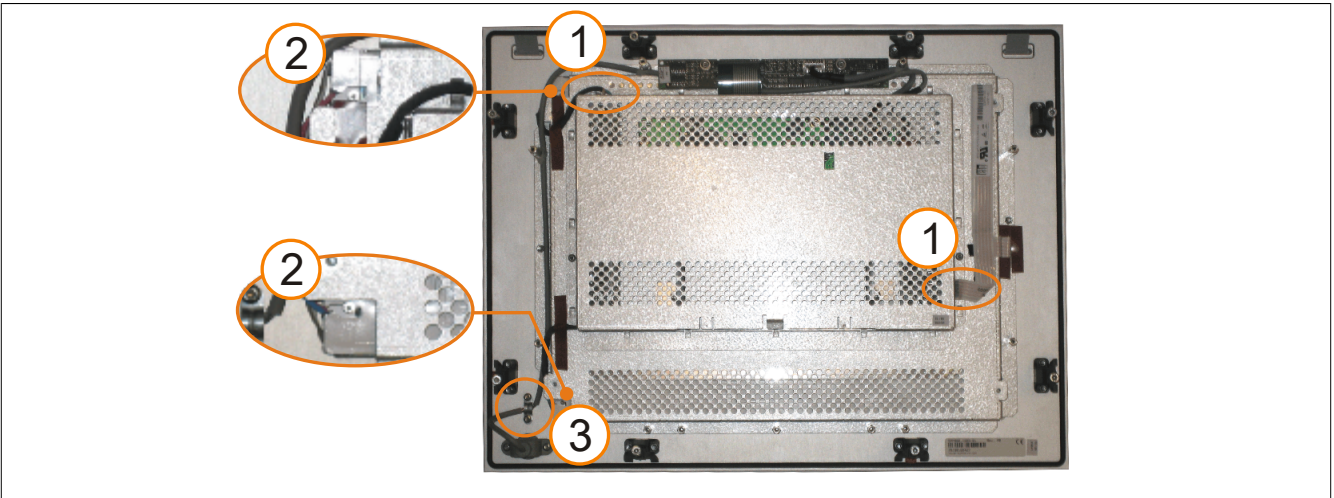

Figure 147: 15" Automation Panels - Unscrewing and disconnecting

- Disconnect the second fluorescent tube. Remove the screws (using a size 10 Torx screwdriver), push and raise the cover (1) and then disconnect the tube (2).

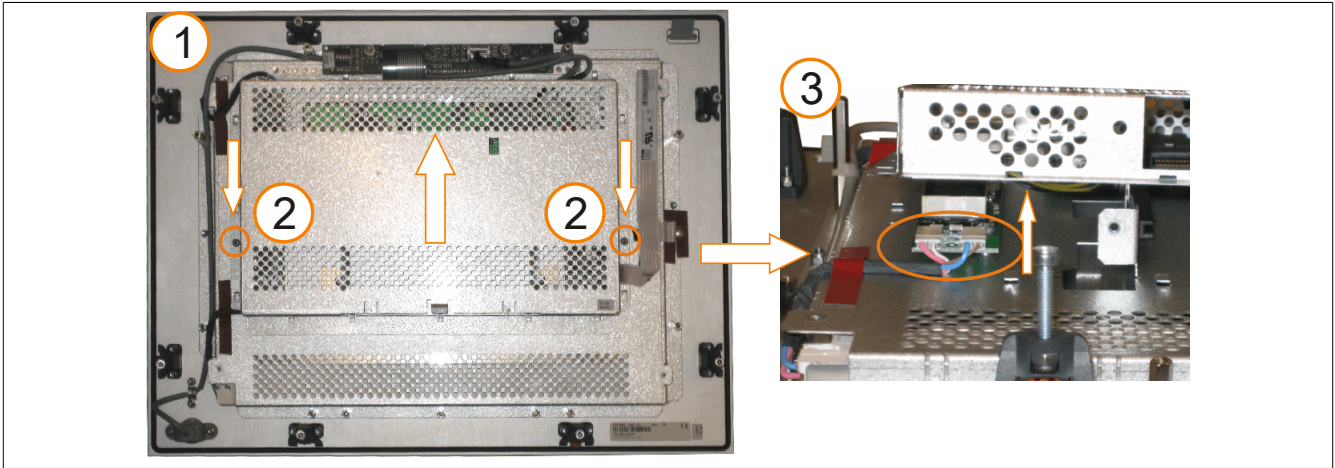

Figure 148: 15" Automation Panels - Removing the cover and disconnecting

- Replace the fluorescent tubes. To do this, carefully pull the tubes out of their holders and replace them with new ones.

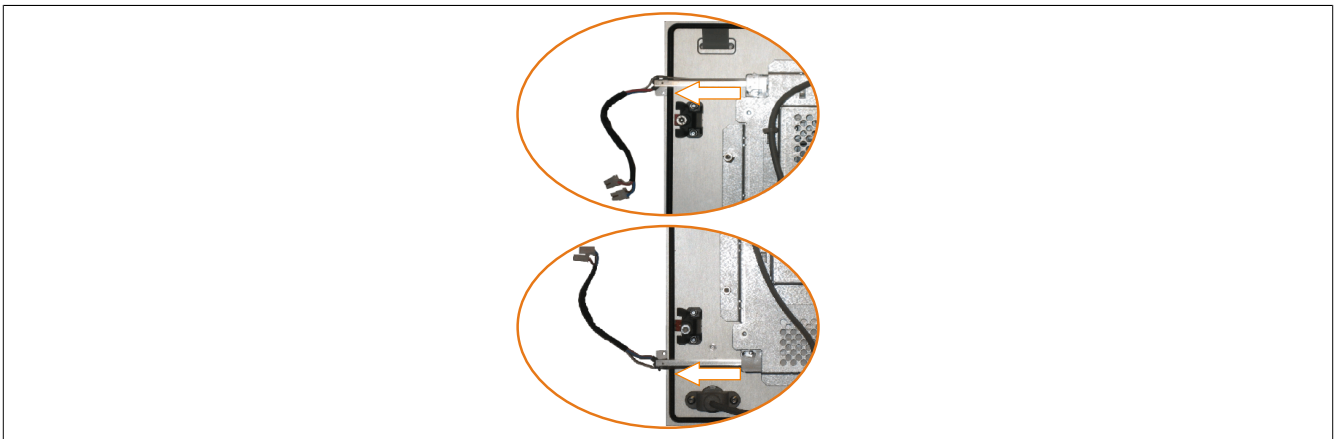

Figure 149: 15" Automation Panel - Replacing the fluorescent tubes

Appendix A

1 Elo AccuTouch screen

1.1 Technical data

Information:

The following characteristics, features and limit values only apply to this individual component and can deviate from those specified for the complete system. For the complete system in which this individual component is used, refer to the data given specifically for that device.

Elo AccuTouch screen	Elo AccuTouch screen
General information	
Manufacturer	Elo
Accuracy	Typically <0.080 inches (2.032 mm)
For diagonals <18"	Maximum error in all directions 0.180 inches (4.752 mm)
For diagonals >18"	Maximum 1% of the diagonal for the active area of the touch screens
Response time	<10 ms
Release pressure	<113 gram
Resolution	4096 x 4096 touch contact points
Light permeability	Up to 80% ±5%
Environmental conditions	
Temperature	
Operation	- 10 to 50°C
Storage	- 40 to 71°C
Transport	- 40 to 71°C
Relative humidity	
Operation	Max. 90% at max. 35°C
Storage	Max. 90% at max. 35°C for 240 hours, non-condensing
Transport	Max. 90% at max. 35°C for 240 hours, non-condensing
Operating conditions	
Waterproofing	IP65
Service life	35 million touch operations at the same position
Chemical resistance ¹⁾	Acetone, ammonia-based glass cleaner, ordinary food and drink, hexane, methylene chloride, methylethylketone, mineral spirits, turpentine, isopropyl alcohol
Enabling	Finger, pointer, credit card, glove
Drivers	Touch screen drivers for approved operating systems are available in the Downloads section of the B&R website (www.br-automation.com). They can also be found on the B&R HMI Drivers & Utilities DVD (model number 5SWHMI.0000-00).

Table 103: Elo AccuTouch screen - Technical data

1) The active area of the touch screen is resistant to these chemicals for a period of one hour at 21°C.

1.2 Temperature humidity diagram

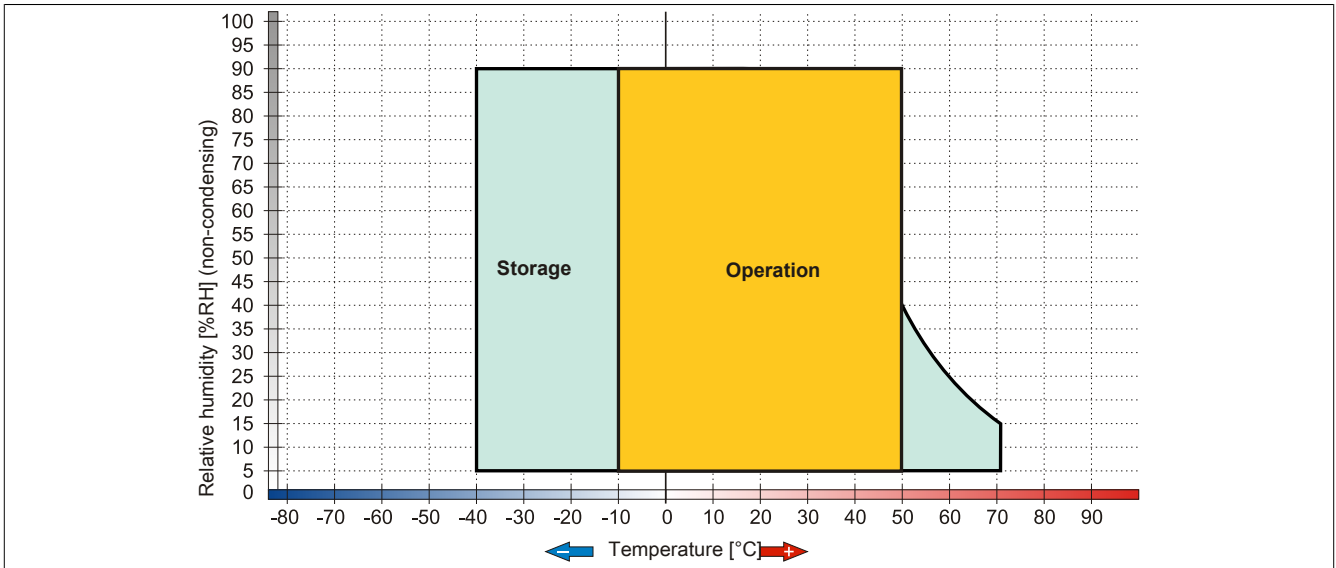

Figure 150: Elo AccuTouch screen (5-wire) - Temperature humidity diagram

1.3 Cleaning

Danger!

This device can only be cleaned when switched off in order to prevent unintended functions from being triggered when handling the touch screen or pressing keys.

This device should be cleaned with a moist cloth. The cloth should be moistened with water and detergent, a screen cleaning agent or alcohol (ethanol). The cleaning agent should be applied to the cloth beforehand, not sprayed directly on the device! Aggressive solvents, chemicals, scouring agents, pressurized air or steam jets should never be used.

Information:

Displays with a touch screen should be cleaned regularly.

2 5-wire AMT touch screen

2.1 Technical data

Information:

The following characteristics, features and limit values only apply to this individual component and can deviate from those specified for the complete system. For the complete system in which this individual component is used, refer to the data given specifically for that device.

Product ID	5-wire AMT touch screen	
General information		
Certification		
CE		Yes
c-UL-us		Yes
Manufacturer		AMT
Release pressure		< 1 N
Light permeability		81 ±3%
Environmental conditions		
Temperature		
Operation		- 20 to 70°C
Storage		- 40 to 80°C
Transport		- 40 to 80°C
Relative humidity		
Operation		90% at max. 50°C
Storage		90% RH at max. 60°C for 504 hours
Transport		90% RH at max. 60°C for 504 hours
Operating conditions		
Service life	36 million touch operations at the same position (release pressure: 250 g, interval: 2x per second)	
Chemical resistance ¹⁾	Acetone, methylene chloride, methyl ethyl ketone, isopropyl alcohol, hexane, turpentine, mineral spirits, unleaded gasoline, diesel, motor oil, gear lubricating oil, antifreeze, ammonia-based glass cleaner, chemical cleaning agents, household cleaning agents, vinegar, coffee, tea, lubricant, cooking oil, salt	
Enabling driver	Finger, pointer, credit card, glove	
	Touch screen drivers for approved operating systems are available in the Downloads section of the B&R website (www.br-automation.com).	

Table 104: 5-wire AMT touch screen - Technical data

1) The active area of the touch screen is resistant to these chemicals for a period of one hour at 25°C.

2.2 Temperature/Humidity diagram

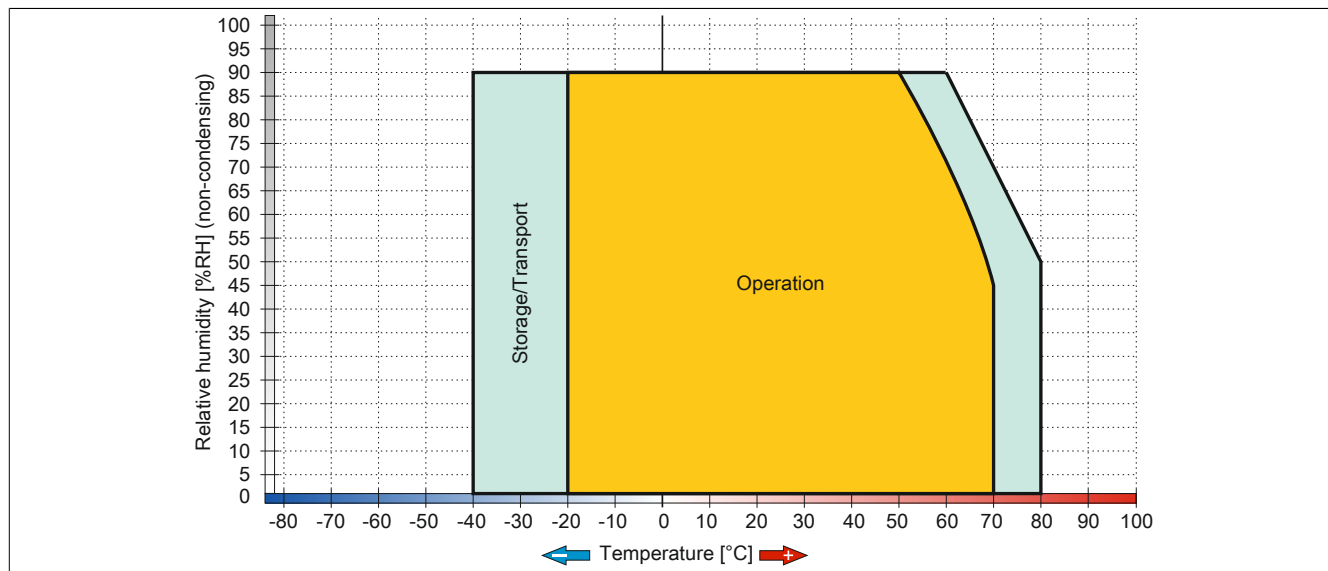

Figure 151: 5-wire AMT touch screen - Temperature/Humidity diagram

2.3 Cleaning

Danger!

This device can only be cleaned when switched off in order to prevent unintended functions from being triggered when handling the touch screen or pressing keys.

This device should be cleaned with a moist cloth. The cloth should be moistened with water and detergent, a screen cleaning agent or alcohol (ethanol). The cleaning agent should be applied to the cloth beforehand, not sprayed directly on the device! Aggressive solvents, chemicals, scouring agents, pressurized air or steam jets should never be used.

Information:

Displays with a touch screen should be cleaned regularly.

3 Panel overlay

The panel overlay conforms to DIN 42115 (Part 2). This means it is resistant to exposure to the following chemicals for a 24-hour period with no visible signs of damage:

Information:

The following characteristics, features and limit values only apply to this individual component and can deviate from those specified for the complete system.

Ethanol Cyclohexanol Diacetone alcohol Glycol Isopropanol Glycerine Methanol Triacetin Dowandol DRM/PM	Formaldehyde 37 to 42% Acetaldehyde Aliphatic hydrocarbons Toluene Xylene White spirits	Trichloroethane Ethyl acetate Diethyl ether N-Butyl acetate Amyl acetate Butylcellosolve Ether
Acetone Methyl ethyl ketone Dioxan Cyclohexanone MIBK Isophorone	Formic acid < 50% Acetic acid < 50% Phosphoric acid < 30% Hydrochloric acid < 36% Nitric acid < 10% Trichloroacetic acid < 50% Sulphuric acid < 10%	Sodium hypochlorite < 20% Hydrogen peroxide < 25% Potassium carbonate Washing agents Tenside Fabric conditioner Ferrous chloride (FeCl ₂) Ferrous chloride (FeCl ₃) Dibutyl phthalate Dioctyl phthalate Sodium carbonate
Ammonia < 40% Caustic soda < 40% Potassium hydroxide Alkali carbonate Bichromate Potassium Acetonitrile Sodium bisulphate	Cutting oil Diesel oil Linseed oil Paraffin oil Blown castor oil Silicon oil Turpentine oil substitute Brake fluid Aviation fuel Gasoline Water Sea water Decon	

Table 105: Chemical resistance of the panel overlay

The panel overlay conforms to DIN 42115 section 2 for exposure to glacial acetic acid for less than one hour without visible damage.

4 Filter glass

Mechanical characteristics

Information:

The following characteristics, features and limit values only apply to this individual component and can deviate from those specified for the fully assembled device. For the assembled device in which this individual component is used, refer to the data given specifically for that device.

Abrasion-resistant in accordance with DIN 52347

Adhesive strength in accordance with DIN 58 196-K2 (Part 6)

Chemical properties

Durability according to DIN 50021 - CASS

5 Viewing angles

Viewing angle specifications (R, L, U, D) for the display types are listed in the technical data for each device.

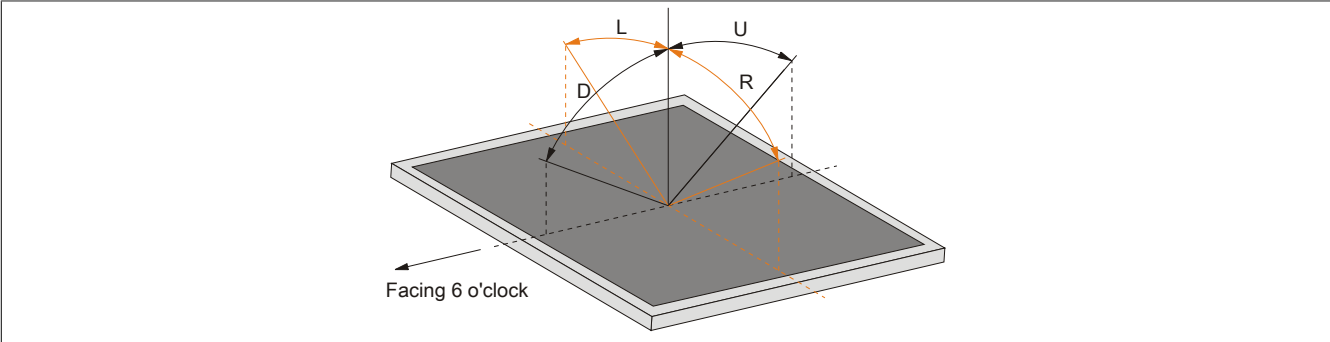

6 Mounting compatibility

This section describes the compatibility of the installation dimensions for Power Panel 100/200, Power Panel 300/400, Power Panel 500, Automation Panel 900, Automation Panel 700 and Panel PC 800 devices according to device display size.

The outer dimensions of the device types are identical for the respective display sizes.

The different device types are abbreviated as follows:

Device type	Abbreviation
Power Panel 100/200	PP100/200
Power Panel 300/400	PP300/400
Power Panel 500	PP500
Automation Panel 900	AP900
Panel PC 700	PPC700
Panel PC 800	PPC800

Table 106: Product abbreviations

6.1 Compatibility overview

The following table provides an overview of PP100/200, PP300/400, PP500, AP900, PPC700 and PPC800 devices. Detailed information can be found in the section 6.2 "Compatibility details" on page 201.

Compatibility between device types is represented on each line by matching symbols.

Size	Format	Compatible	PP100/200	PP300/400	PP500	AP900	PPC700	PPC800
5.7"	Horizontal1	Outer dimensions	■	■	■	-	-	-
		Installation dimensions	●	●	●	-	-	-
	Horizontal2	Outer dimensions	■	■	■	-	-	-
		Installation dimensions	●	●	●	-	-	-
	Vertical1	Outer dimensions	■	■	■	-	-	-
		Installation dimensions	●	●	▲	-	-	-
10.4"	Horizontal 1	Outer dimensions	■	■	■	■	■	-
		Installation dimensions	●	●	●	●	●	-
	Horizontal2	Outer dimensions	■	■	■	■	■	-
		Installation dimensions	●	●	▲	▲	▲	-
	Vertical1	Outer dimensions	■	■	■	■	■	-
		Installation dimensions	●	●	▲	▲	▲	-
12.1"	Horizontal1	Outer dimensions	■	■	■	■	■	-
		Installation dimensions	●	●	▲	▲	▲	-
15"	Horizontal1	Outer dimensions	■	■	■	■	■	■
		Installation dimensions	●	●	▲	●	●	●
	Vertical1	Outer dimensions	■	■	■	■	■	-
		Installation dimensions	●	●	▲	●	●	-
17"	Horizontal 1	Outer dimensions	-	-	-	■	■	-
		Installation dimensions	-	-	-	▲	▲	-
19"	Horizontal 1	Outer dimensions	-	-	-	■	■	-
		Installation dimensions	-	-	-	▲	-	-
21.3"	Horizontal 1	Outer dimensions	-	-	-	■	-	-
		Installation dimensions	-	-	-	▲	-	-

Table 107: Overview of device compatibility

6.2 Compatibility details

6.2.1 Example

The dimensions (all in mm) shown in this image apply to the other figures below.

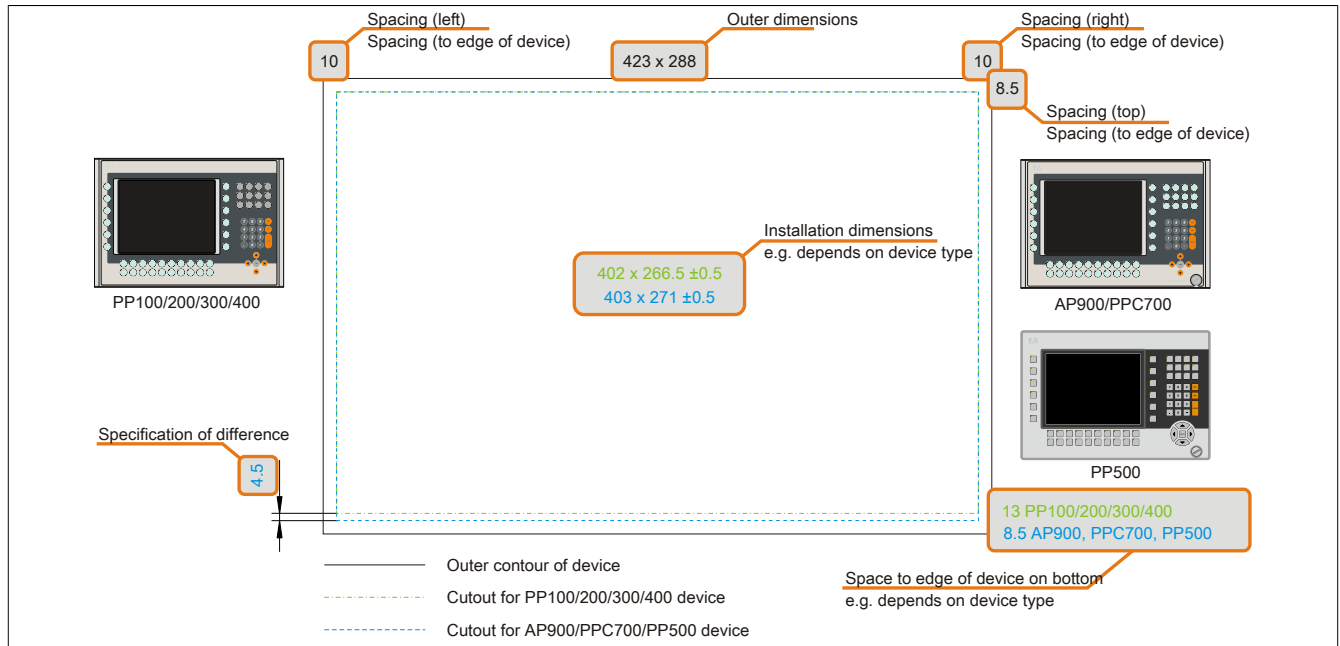

Figure 152: Overview of compatibility figures

6.2.2 5.7" devices

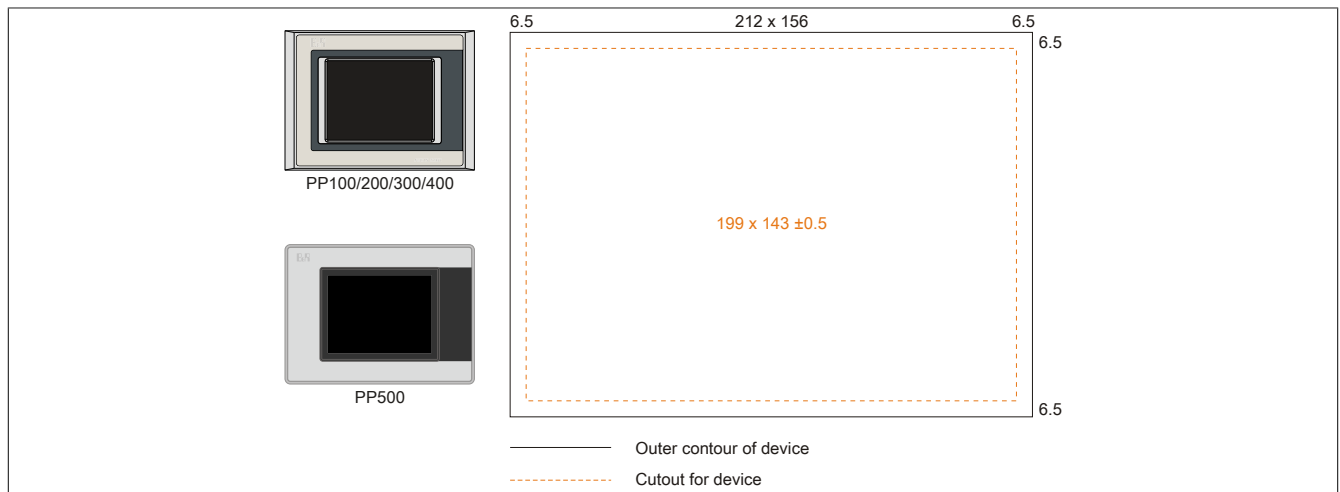

Figure 153: Mounting compatibility - 5.7" device - Horizontal1

5.7" Power Panel 500 devices and Power Panel 100/200/300/400 devices are 100% mounting compatible in the Horizontal1 format.

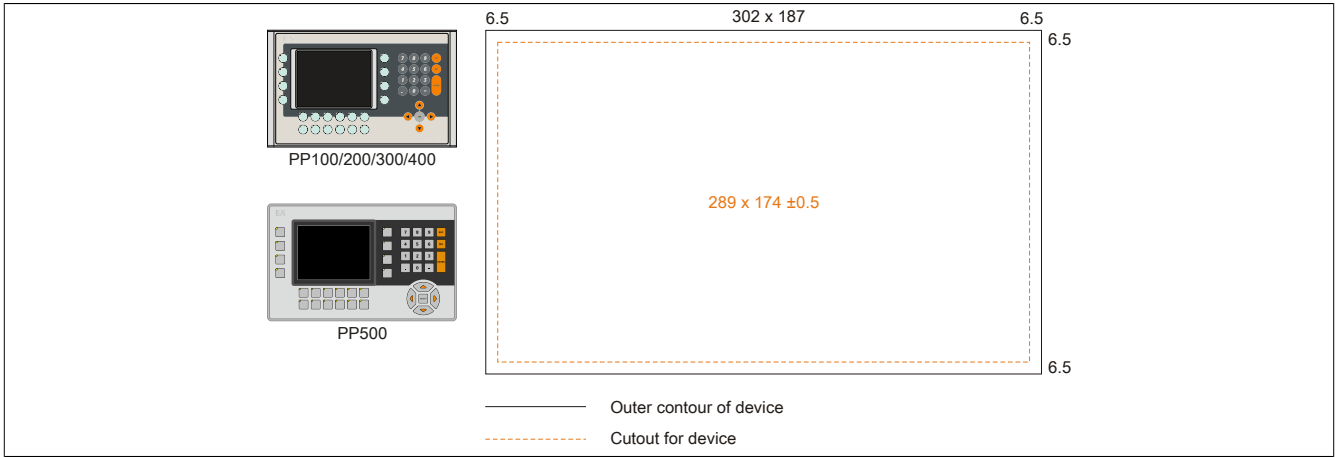

Figure 154: Mounting compatibility - 5.7" device - Horizontal2

5.7" Power Panel 500 devices and Power Panel 100/200300/400 devices are 100% mounting compatible in the Horizontal2 format.

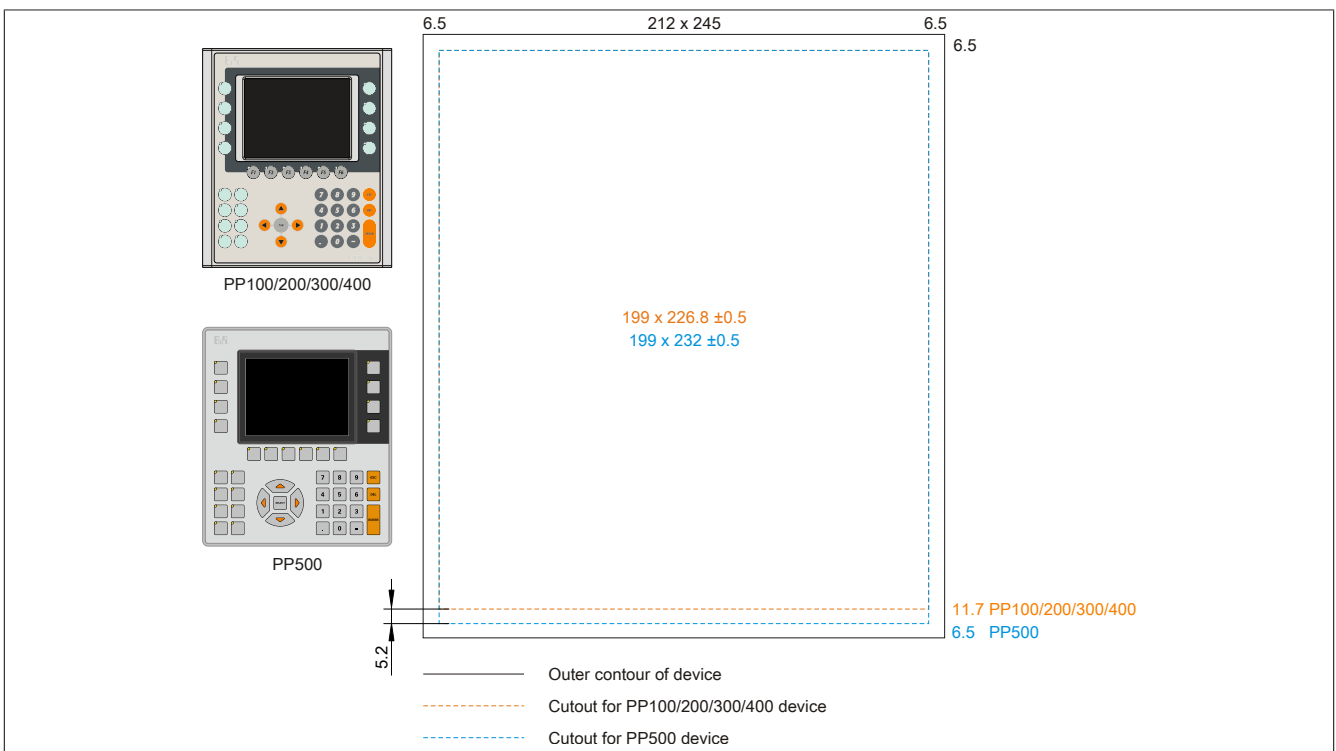

Figure 155: Mounting compatibility - 5.7" device - Vertical1

5.7" Power Panel 500 devices are not 100% mounting compatible with Power Panel 100/200/300/400 devices in the Vertical1 format. Power Panel 500 devices require a cutout that is 5.2 mm higher (bottom edge).

The larger cutout can be used for all devices under certain conditions:

- When mounting, make sure that the PP100/200/300/400 devices are placed and mounted as close to the center of the cutout as possible. Failure to do so can prevent the retaining clips from holding firmly, which means that a firm seal is no longer guaranteed with the gasket (IP65).

6.2.3 10.4" devices

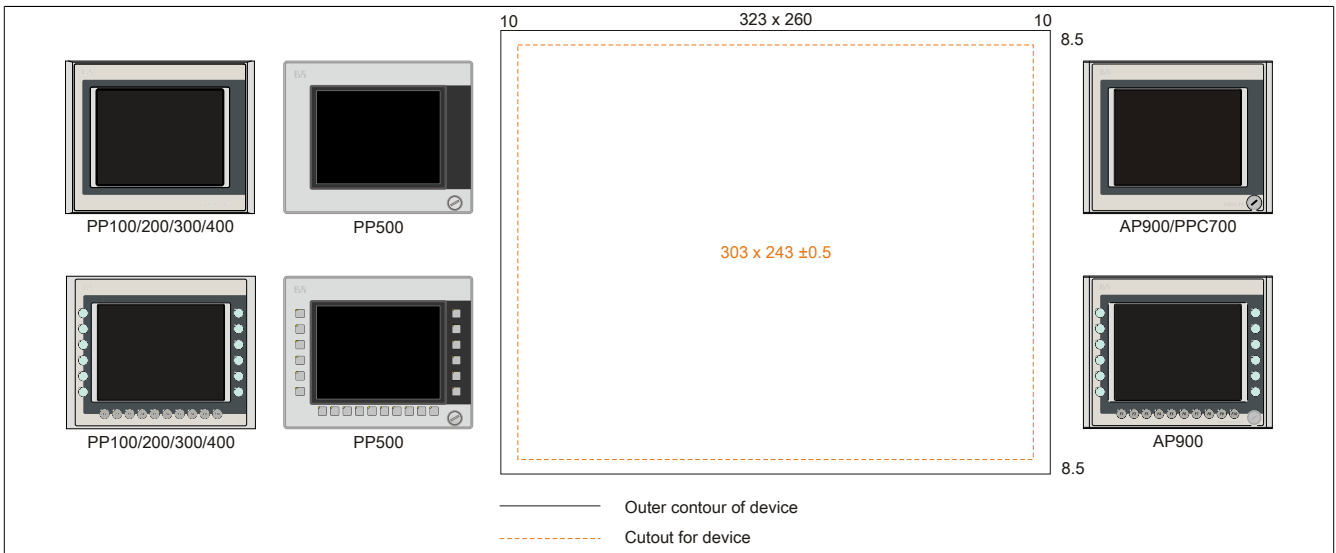

Figure 156: Mounting compatibility - 10.4" device - Horizontal1

10.4" Power Panel 500 devices and Power Panel 100/200/300/400 devices are 100% mounting compatible in the Horizontal1 format.

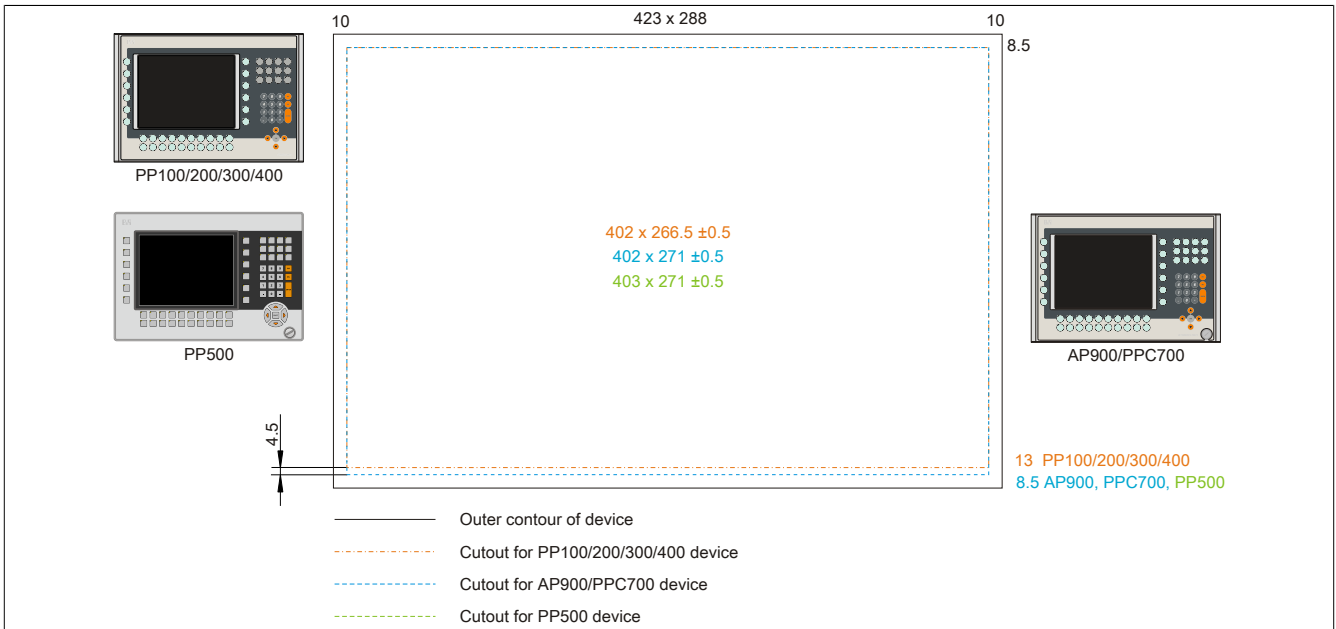

Figure 157: Mounting compatibility - 10.4" device - Horizontal2

10.4" Power Panel 500, Automation Panel 900 and Panel PC 700 devices are not 100% mounting compatible with Power Panel 100/200/300/400 devices in the Horizontal2 format. The Power Panel 500, Automation Panel 900 and Panel PC 700 devices require a cutout that is 4.5 mm higher (bottom edge).

The larger cutout can be used for all devices under certain conditions:

- When mounting, make sure that the PP100/200/300/400 devices are placed and mounted as close to the center of the cutout as possible. Failure to do so can prevent the retaining clips from holding firmly, which means that a firm seal is no longer guaranteed with the gasket (IP65).

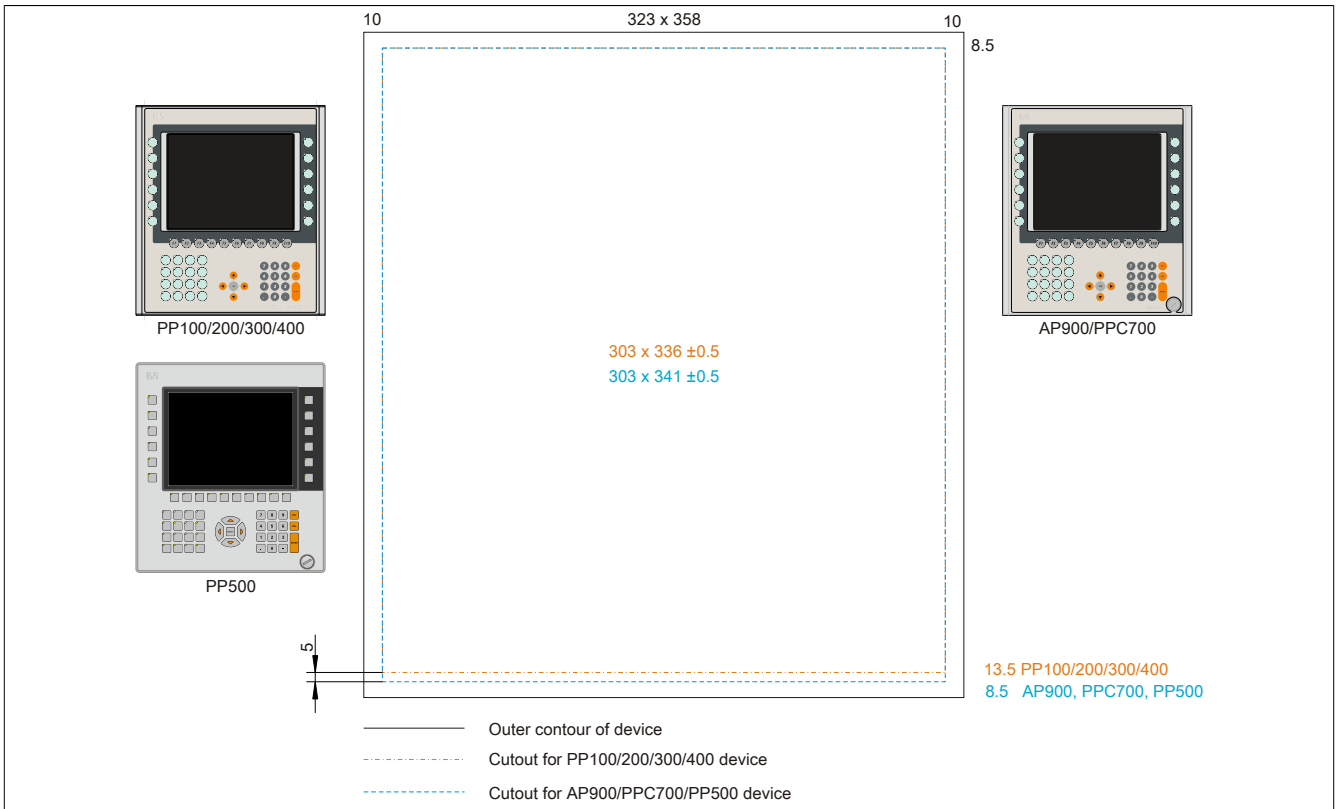

Figure 158: Mounting compatibility - 10.4" device - Vertical1

10.4" Power Panel 500, Automation Panel 900 and Panel PC 700 devices are not 100% mounting compatible with Power Panel 100/200/300/400 devices in Vertical1 format. The Power Panel 500, Automation Panel 900 and Panel PC 700 devices require a cutout that is 5 mm higher (bottom edge).

The larger cutout can be used for all devices under certain conditions:

- When mounting, make sure that the PP100/200/300/400 devices are placed and mounted as close to the center of the cutout as possible. Failure to do so can prevent the retaining clips from holding firmly, which means that a firm seal is no longer guaranteed with the gasket (IP65).

6.2.4 12.1" devices

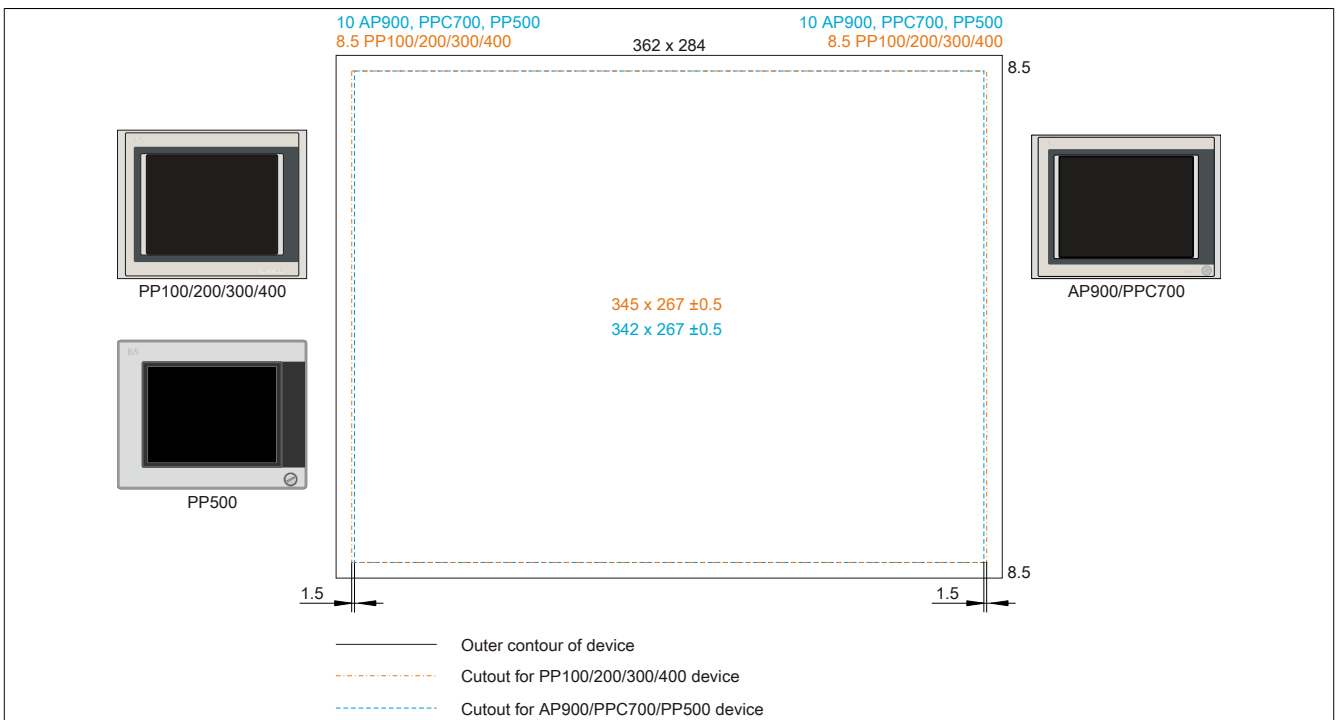

Figure 159: Mounting compatibility - 12.1" device - Horizontal1

12.1" Power Panel 500, Automation Panel 900 and Panel PC 700 devices are not 100% mounting compatible with Power Panel 100/200/300/400 devices in Horizontal1 format. The Power Panel 300/400 and Power Panel 100/200 devices require a cut that is 1.5 mm wider (left and right).

The larger cutout can be used for all devices under certain conditions:

- When mounting, make sure that the PP500, AP900 and PPC700 devices are mounted as close to the center of the cutout as possible.

6.2.5 15" devices

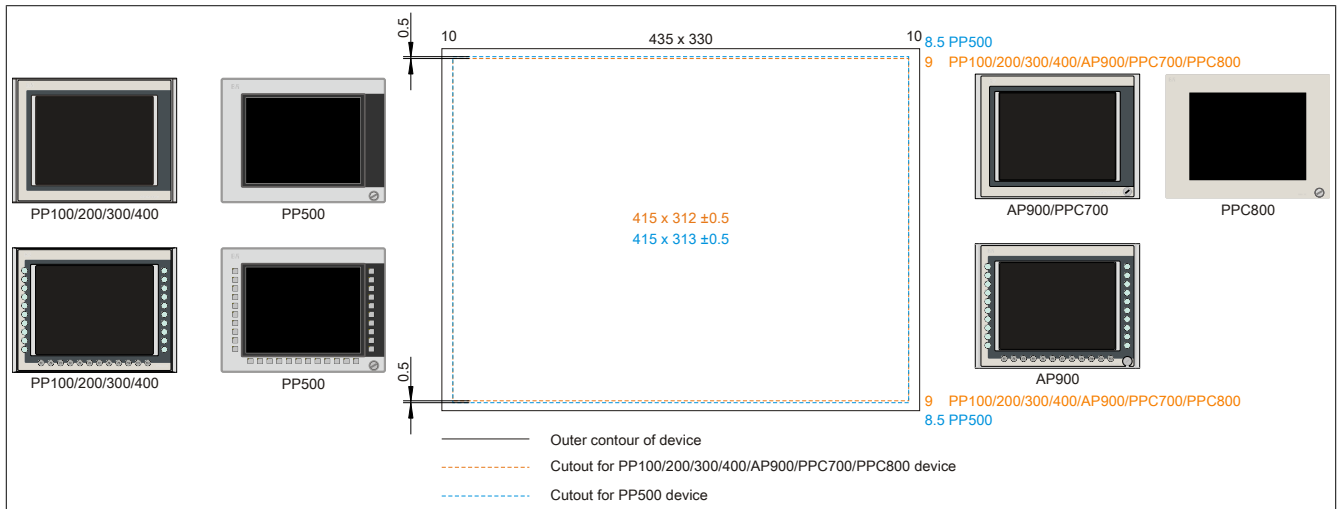

Figure 160: Mounting compatibility - 15" device - Horizontal1

15" Power Panel 500 devices are not 100% mounting compatible with Power Panel 100/200/300/400, Automation Panel 900, Panel PC 700 and Panel PC 800 devices in the Vertical1 format. The Power Panel 500 devices require a cutout that is 0.5 mm higher (top and bottom edge).

The larger cutout can be used for all devices under certain conditions:

- When mounting, make sure that the PP100/200, PP300/400, AP900, PPC700 and PPC800 devices are placed and mounted as close to the center of the cutout as possible. Failure to do so can prevent the retaining clips from holding firmly, which means that a firm seal is no longer guaranteed with the gasket (IP65).

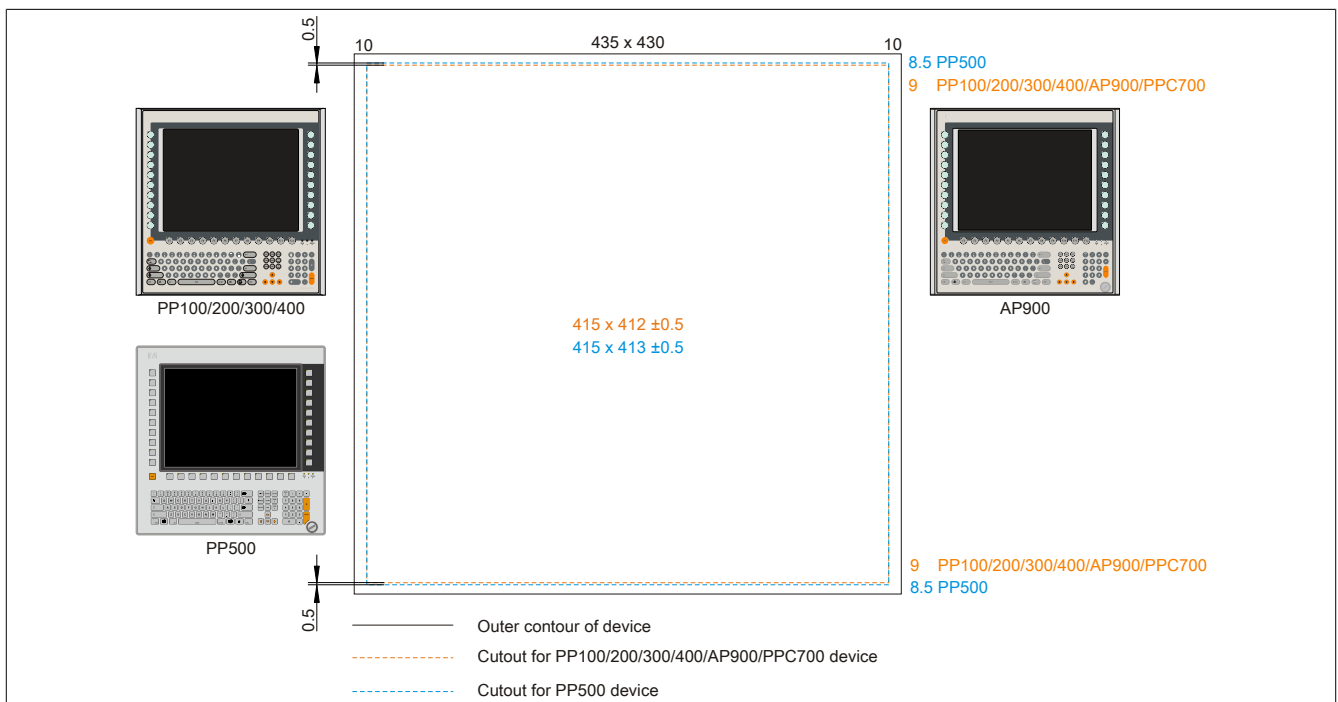

Figure 161: Mounting compatibility - 15" device - Vertical1

15" Power Panel 500 devices are not 100% mounting compatible with Power Panel 100/200/300/400, Automation Panel 900 and Panel PC 700 devices in the Vertical1 format. The Power Panel 500 devices require a cutout that is 0.5 mm higher (top and bottom edge).

The larger cutout can be used for all devices under certain conditions:

- When mounting, make sure that the PP100/200, PP300/400, AP900 and PPC700 devices are mounted as close to the center of the cutout as possible. Failure to do so can prevent the retaining clips from holding firmly, which means that a firm seal is no longer guaranteed with the gasket (IP65).

6.2.6 17" devices

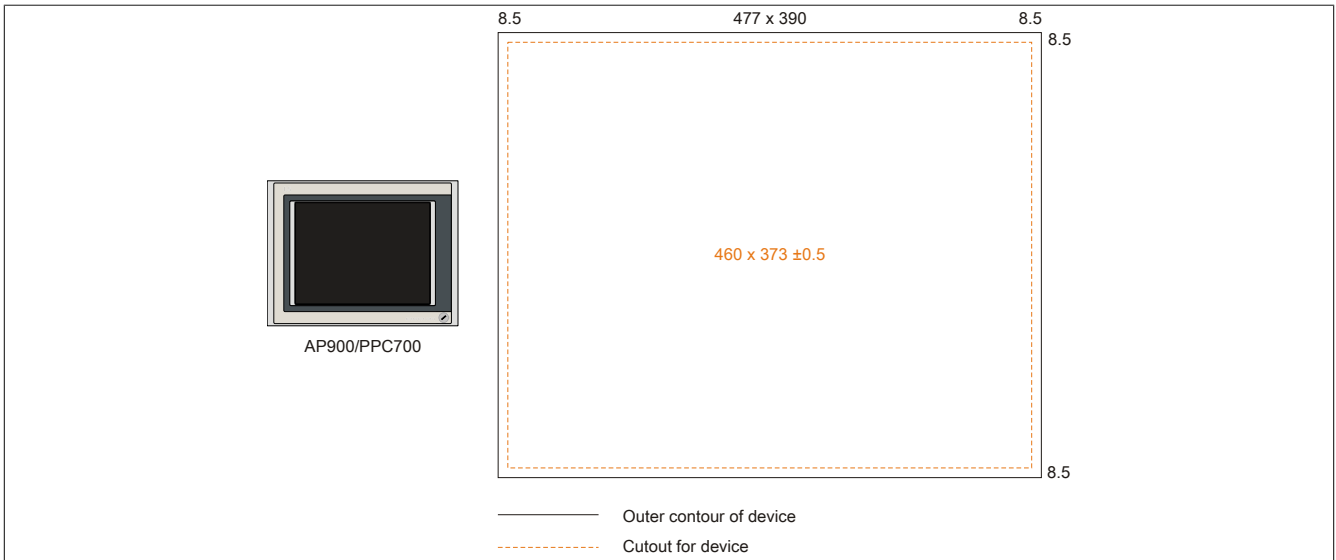

Figure 162: Mounting compatibility - 17" device - Horizontal1

17" Automation Panel 900 devices are 100% mounting compatible with Panel PC 700 devices in the Horizontal1 format.

6.2.7 19" devices

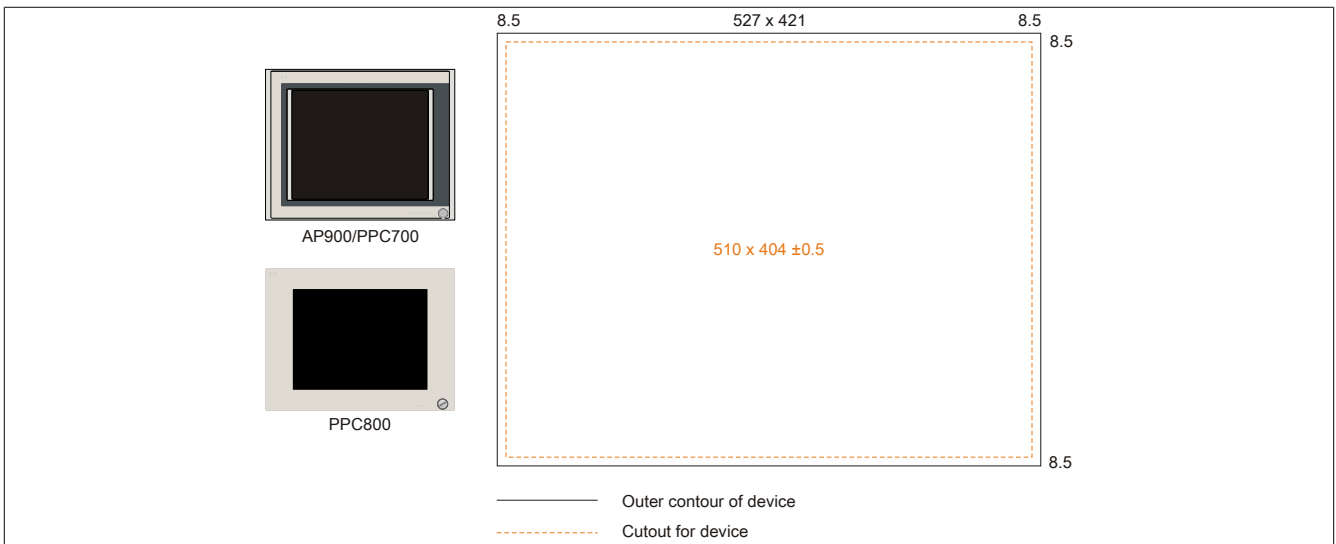

Figure 163: Mounting compatibility - 19" device - Horizontal1

19" Automation Panel 900, Panel PC 700 and Panel PC 800 are 100% mounting compatible in the Horizontal1 format.

6.2.8 21.3" devices

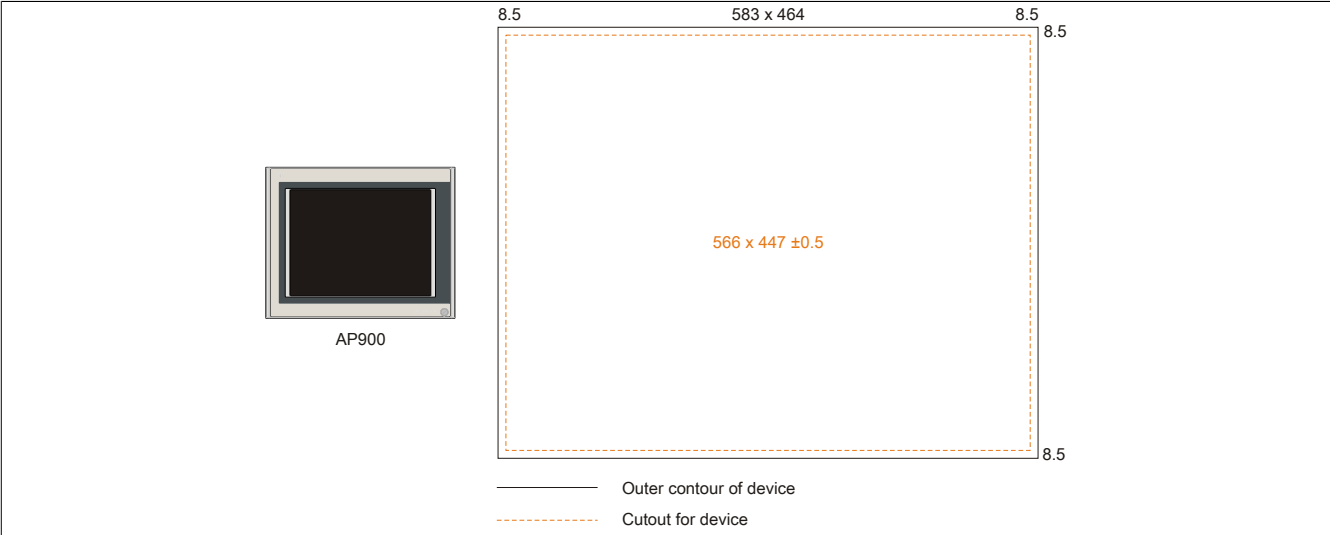

Figure 164: Mounting compatibility - 21.1" device - Horizontal1

7 Glossary

APC	Abbreviation for »Automation PC«
Application software	Software, which is not used for operation by the computer itself, but rather when a computer is used to process a concrete application problem. It sets up the system software and uses this for fulfilling individual tasks. Application software can be accommodated in standard software used by a large number of customers in a wide range of industries. Common examples are Word, Excel, PowerPoint, Paint, Matlab etc. Industrial software tailored to the respective problems of a certain industry and individual software created for solving the particular problems of an individual user.
Automation	According to Brockhaus: The application of technical means, using specific programs that (either partially or totally) do not require human intervention to perform operations.
Automation Runtime	A uniform runtime system for all B&R automation components.
Failure	Failure according to IEC 61508: A function unit loses the ability to perform a required function. In regards to safety-oriented systems, a distinction is made between dangerous and safe failures. This depends on whether the status of the system failure is considered dangerous or safe. The cause of the failure may be load related or age-related, and therefore a random failure, or related to a flaw inherent in the system. In this case, it is known as a systematic failure.

Figure 1:	Automation Panel and Automation Panel Link plug-in card.....	18
Figure 2:	USB interfaces on the Automation Panel (front and back).....	18
Figure 3:	AP900 block diagram.....	23
Figure 4:	AP900 block diagram with DVI Link.....	23
Figure 5:	AP900 with SDL receiver - Block diagram.....	24
Figure 6:	AP900 with SDL transceiver - Block diagram.....	24
Figure 7:	AP900 with SDL3 receiver - Block diagram.....	25
Figure 8:	Serial number sticker (back).....	26
Figure 9:	Example of serial number search.....	26
Figure 10:	5AP920.1043-01 - Front view.....	27
Figure 11:	5AP920.1043-01 - Rear view	27
Figure 12:	5AP920.1043-01 - Temperature humidity diagram.....	30
Figure 13:	5AP920.1043-01 - Dimensions	30
Figure 14:	5AP920.1043-01 - Cutout installation.....	31
Figure 15:	5AP951.1043-01 - Front view.....	32
Figure 16:	5AP951.1043-01 - Rear view.....	32
Figure 17:	5AP951.1043-01 - Temperature humidity diagram.....	34
Figure 18:	5AP951.1043-01 - Dimensions.....	35
Figure 19:	5AP951.1043-01 - Cutout installation.....	36
Figure 20:	5AP952.1043-01 - Front view.....	37
Figure 21:	5AP952.1043-01 - Rear view.....	37
Figure 22:	5AP952.1043-01 - Temperature humidity diagram.....	39
Figure 23:	5AP952.1043-01 - Dimensions.....	40
Figure 24:	5AP952.1043-01 - Cutout installation.....	41
Figure 25:	5AP980.1043-01 - Front view	42
Figure 26:	5AP980.1043-01 - Rear view	42
Figure 27:	5AP980.1043-01 - Temperature humidity diagram.....	45
Figure 28:	5AP980.1043-01 - Dimensions	45
Figure 29:	5AP980.1043-01 - Cutout installation.....	46
Figure 30:	5AP981.1043-01 - Front view.....	47
Figure 31:	5AP981.1043-01 - Rear view.....	47
Figure 32:	5AP981.1043-01 - Temperature humidity diagram.....	50
Figure 33:	5AP981.1043-01 - Dimensions.....	50
Figure 34:	5AP981.1043-01 - Cutout installation.....	51
Figure 35:	5AP982.1043-01 - Front view.....	52
Figure 36:	5AP982.1043-01 - Rear view.....	52
Figure 37:	5AP982.1043-01 - Temperature humidity diagram.....	55
Figure 38:	5AP982.1043-01 - Dimensions.....	55
Figure 39:	5AP982.1043-01 - Cutout installation.....	56
Figure 40:	5AP920.1214-01 - Front view.....	57
Figure 41:	5AP920.1214-01 - Rear view	57
Figure 42:	5AP920.1214-01 - Temperature humidity diagram.....	60
Figure 43:	5AP920.1214-01 - Dimensions	60
Figure 44:	5AP920.1214-01 - Cutout installation	61
Figure 45:	5AP920.1505-01 - Front view.....	62
Figure 46:	5AP920.1505-01 - Rear view	62
Figure 47:	5AP920.1505-01 - Temperature humidity diagram.....	65
Figure 48:	5AP920.1505-01 - Dimensions	65
Figure 49:	5AP920.1505-01 - Cutout installation.....	66
Figure 50:	5AP951.1505-01 - Front view.....	67
Figure 51:	5AP951.1505-01 - Rear view.....	67
Figure 52:	5AP951.1505-01 - Temperature humidity diagram.....	70
Figure 53:	5AP951.1505-01 - Dimensions.....	70
Figure 54:	5AP951.1505-01 - Cutout installation.....	71
Figure 55:	5AP920.1505-01 - Front view	72
Figure 56:	5AP980.1505-01 - Rear view	72
Figure 57:	5AP980.1505-01 - Temperature humidity diagram.....	75

Figure 58:	5AP980.1505-01 - Dimensions	75
Figure 59:	5AP980.1505-01 - Cutout installation.....	76
Figure 60:	5AP981.1505-01 - Front view.....	77
Figure 61:	5AP981.1505-01 - Rear view.....	77
Figure 62:	5AP981.1505-01 - Temperature humidity diagram.....	80
Figure 63:	5AP981.1505-01 - Dimensions.....	80
Figure 64:	5AP981.1505-01 - Cutout installation.....	81
Figure 65:	5AP920.1706-01 - Front view.....	82
Figure 66:	5AP920.1706-01 - Rear view	82
Figure 67:	5AP920.1706-01 - Temperature humidity diagram	85
Figure 68:	5AP920.1706-01 - Dimensions	85
Figure 69:	5AP920.1706-01 - Cutout installation	86
Figure 70:	5AP920.1906-01 - Front view.....	87
Figure 71:	5AP920.1906-01 - Rear view	87
Figure 72:	5AP920.1906-01 - Temperature humidity diagram	90
Figure 73:	5AP920.1906-01 - Dimensions	90
Figure 74:	5AP920.1906-01 - Cutout installation	91
Figure 75:	5AP920.2138-01 - Front view.....	92
Figure 76:	5AP920.2138-01 - Rear view	92
Figure 77:	5AP920.2138-01 - Temperature humidity diagram	94
Figure 78:	5AP920.2138-01 - Dimensions	95
Figure 79:	5AP920.2138-01 - Cutout installation	96
Figure 80:	Automation Panel and Automation Panel Link plug-in card.....	97
Figure 81:	5DL DVI.1000-01 - Interfaces.....	99
Figure 82:	Comparison of USB Type A/B connectors.....	99
Figure 83:	5DLSDL.1000-00 - Interfaces.....	102
Figure 84:	5DLSDL.1000-01 - Interfaces.....	104
Figure 85:	Clamping blocks.....	109
Figure 86:	Mounting orientation 0°.....	111
Figure 87:	Mounting orientations -45° and +45°.....	111
Figure 88:	Spacing for air circulation - Side view.....	113
Figure 89:	Spacing for air circulation - Rear view.....	113
Figure 90:	Cable clamps.....	114
Figure 91:	Functional grounding clip.....	114
Figure 92:	Settings for Passmark BurnInTest Pro V4 and a 2-slot APC810 with DVD.....	116
Figure 93:	Test overview of a 2-slot APC810 with DVD.....	117
Figure 94:	One Automation Panel 900 system via onboard DVI.....	120
Figure 95:	One Automation Panel 900 system via onboard SDL.....	122
Figure 96:	Four Automation Panel 900 systems via onboard SDL.....	124
Figure 97:	One Automation Panel 900 via SDL3 (sample photo).....	126
Figure 98:	Remote connection of USB peripheral devices on the APC900 via DVI.....	128
Figure 99:	Remote connection of USB peripheral devices on the APC800/900 via SDL.....	129
Figure 100:	Remote connection of USB peripheral devices to the 900 via SDL3.....	130
Figure 101:	Hardware numbers in the B&R Key Editor and B&R Control Center.....	131
Figure 102:	Keys and LEDs in the matrix.....	131
Figure 103:	5AP951.1043-01 / 5AP981.1043-01 - Hardware numbers.....	132
Figure 104:	5AP952.1043-01 / 5AP982.1043-01 - Hardware numbers.....	132
Figure 105:	5AP980.1043-01 - Hardware numbers.....	133
Figure 106:	5AP951.1505-01 / 5AP981.1505-01 - Hardware numbers.....	133
Figure 107:	5AP980.1505-01 - Hardware numbers.....	134
Figure 108:	ADI Control Center screenshots - Examples.....	137
Figure 109:	ADI Development Kit Screenshots (Version 3.70).....	139
Figure 110:	ADI .NET SDK screenshots (version 2.10).....	141
Figure 111:	B&R Key Editor screenshots (version 3.50).....	143
Figure 112:	GL certificate no. 11 859 - 10 HH.....	148
Figure 113:	Test structure - Torsion.....	149
Figure 114:	Test structure - Cable drag chain.....	150

Figure 115:	Flex radius specifications.....	156
Figure 116:	5CADVI.0xxx-00 - Dimensions.....	156
Figure 117:	5CADVI.0xxx-00 - Pinout.....	157
Figure 118:	Flex radius specifications.....	159
Figure 119:	5CASDL.0xxx-00- Dimensions.....	159
Figure 120:	5CASDL.0xxx-00 - Pinout.....	160
Figure 121:	Flex radius specifications.....	162
Figure 122:	5CASDL.0xxx-01 - Dimensions.....	162
Figure 123:	5CASDL.0xxx-01 - Pinout.....	163
Figure 124:	Flex radius specifications.....	165
Figure 125:	5CASDL.0xxx-03 - Dimensions.....	165
Figure 126:	5CASDL.0xxx-03 - Pinout.....	166
Figure 127:	Flex radius specification with extender.....	168
Figure 128:	5CASDL.0xx0-13 - Dimensions.....	168
Figure 129:	5CASDL.0xx0-13 - Pinout.....	169
Figure 130:	Example of the signal direction for an SDL flex cable with extender.....	170
Figure 131:	Example of the signal direction for an SDL flex cable with extender.....	170
Figure 132:	SDL3 - Flex radius specifications.....	172
Figure 133:	5CASD3.xxxx-00 - Dimensions.....	172
Figure 134:	5CASD3.xxxx-00 - Pinout.....	173
Figure 135:	Cabling with a field-assembled cable.....	173
Figure 136:	5CAUSB.00xx-00 USB cables - Pinout.....	174
Figure 137:	9A0014.xx RS232 cables - Pinout	176
Figure 138:	5MMUSB.2048-00 - Temperature/Humidity diagram.....	180
Figure 139:	5MMUSB.xxxx-01 - Temperature/Humidity diagram.....	182
Figure 140:	5AC804.MFLT-00 - Dimensions.....	185
Figure 141:	5AC804.MFLT-00 - Drilling template.....	185
Figure 142:	Connection example.....	185
Figure 143:	Removing the cover.....	190
Figure 144:	Warning - Replacing the fluorescent tubes.....	191
Figure 145:	12.1" Automation Panels - Unscrewing and disconnecting.....	191
Figure 146:	12.1" Automation Panels - Replacing the fluorescent tube.....	192
Figure 147:	15" Automation Panels - Unscrewing and disconnecting.....	192
Figure 148:	15" Automation Panels - Removing the cover and disconnecting.....	193
Figure 149:	15" Automation Panel - Replacing the fluorescent tubes.....	193
Figure 150:	Elo AccuTouch screen (5-wire) - Temperature humidity diagram.....	195
Figure 151:	5-wire AMT touch screen - Temperature/Humidity diagram.....	196
Figure 152:	Overview of compatibility figures.....	201
Figure 153:	Mounting compatibility - 5.7" device - Horizontal1.....	201
Figure 154:	Mounting compatibility - 5.7" device - Horizontal2.....	202
Figure 155:	Mounting compatibility - 5.7" device - Vertical1.....	202
Figure 156:	Mounting compatibility - 10.4" device - Horizontal1.....	203
Figure 157:	Mounting compatibility - 10.4" device - Horizontal2.....	203
Figure 158:	Mounting compatibility - 10.4" device - Vertical1.....	204
Figure 159:	Mounting compatibility - 12.1" device - Horizontal1.....	204
Figure 160:	Mounting compatibility - 15" device - Horizontal1.....	205
Figure 161:	Mounting compatibility - 15" device - Vertical1.....	205
Figure 162:	Mounting compatibility - 17" device - Horizontal1.....	206
Figure 163:	Mounting compatibility - 19" device - Horizontal1.....	206
Figure 164:	Mounting compatibility - 21.1" device - Horizontal1.....	207

Table 1:	Manual history.....	8
Table 2:	Environmentally friendly separation of materials.....	13
Table 3:	Description of the safety notices used in this documentation.....	14
Table 4:	Range of nominal sizes.....	14
Table 5:	Ambient temperature - AP900 without Rittal housing.....	19
Table 6:	Ambient temperature - AP900 with Rittal housing.....	19
Table 7:	Overview of humidity specifications for individual components.....	21
Table 8:	Power management according to mounting orientation.....	22
Table 9:	5AP920.1043-01 - Order data.....	28
Table 10:	5AP920.1043-01, 5AP920.1043-01, 5AP920.1043-01, 5AP920.1043-01 - Technical data.....	28
Table 11:	5AP951.1043-01 - Order data.....	32
Table 12:	5AP951.1043-01 - Technical data.....	33
Table 13:	5AP952.1043-01 - Order data.....	37
Table 14:	5AP952.1043-01 - Technical data.....	38
Table 15:	5AP980.1043-01 - Order data.....	42
Table 16:	5AP980.1043-01, 5AP980.1043-01, 5AP980.1043-01, 5AP980.1043-01 - Technical data.....	43
Table 17:	5AP981.1043-01 - Order data.....	48
Table 18:	5AP981.1043-01, 5AP981.1043-01, 5AP981.1043-01, 5AP981.1043-01 - Technical data.....	48
Table 19:	5AP982.1043-01 - Order data.....	52
Table 20:	5AP982.1043-01, 5AP982.1043-01, 5AP982.1043-01, 5AP982.1043-01 - Technical data.....	53
Table 21:	5AP920.1214-01 - Order data.....	57
Table 22:	5AP920.1214-01, 5AP920.1214-01, 5AP920.1214-01 - Technical data.....	58
Table 23:	5AP920.1505-01 - Order data.....	62
Table 24:	5AP920.1505-01, 5AP920.1505-01, 5AP920.1505-01 - Technical data.....	63
Table 25:	5AP951.1505-01 - Order data.....	67
Table 26:	5AP951.1505-01 - Technical data.....	68
Table 27:	5AP980.1505-01 - Order data.....	72
Table 28:	5AP980.1505-01, 5AP980.1505-01, 5AP980.1505-01 - Technical data.....	73
Table 29:	5AP981.1505-01 - Order data.....	78
Table 30:	5AP981.1505-01, 5AP981.1505-01, 5AP981.1505-01 - Technical data.....	78
Table 31:	5AP920.1706-01 - Order data.....	83
Table 32:	5AP920.1706-01, 5AP920.1706-01 - Technical data.....	83
Table 33:	5AP920.1906-01 - Order data.....	87
Table 34:	5AP920.1906-01, 5AP920.1906-01, 5AP920.1906-01, 5AP920.1906-01 - Technical data.....	88
Table 35:	5AP920.2138-01 - Order data.....	93
Table 36:	5AP920.2138-01 - Technical data.....	93
Table 37:	5DL DVI.1000-01 - Order data.....	98
Table 38:	5DL DVI.1000-01 - Technical data.....	98
Table 39:	COM - Pinout.....	100
Table 40:	Supply voltage connection 24 VDC.....	100
Table 41:	5DLSDL.1000-00 - Order data.....	101
Table 42:	5DLSDL.1000-00 - Technical data.....	101
Table 43:	Supply voltage connection 24 VDC.....	102
Table 44:	5DLSDL.1000-01 - Order data.....	103
Table 45:	5DLSDL.1000-01 - Technical data.....	103
Table 46:	Supply voltage connection 24 VDC.....	104
Table 47:	5DLSD3.1000-00 - Order data.....	105
Table 48:	5DLSD3.1000-00 - Technical data.....	106
Table 49:	SDL3 In interface.....	106
Table 50:	SDL3 In LEDs.....	107
Table 51:	USB1 interface.....	107
Table 52:	Supply voltage connection 24 VDC.....	108
Table 53:	Evaluation example using a 2-slot APC810.....	118
Table 54:	Selecting display units.....	119
Table 55:	Link modules.....	120
Table 56:	Cables for DVI configurations.....	120
Table 57:	Possible Automation Panel devices, resolutions and segment lengths.....	121

Table 58:	Link modules.....	122
Table 59:	Cables for SDL configurations.....	122
Table 60:	Cable lengths and resolutions for SDL transmission.....	123
Table 61:	Link modules.....	124
Table 62:	Cables for SDL configurations.....	124
Table 63:	Cable lengths and resolutions for SDL transmission.....	125
Table 64:	Link modules.....	126
Table 65:	Cables for SDL3 configurations.....	126
Table 66:	Cable lengths and resolutions for SDL3 transmission.....	126
Table 67:	GL certifications.....	146
Table 68:	0TB103.9, 0TB103.91 - Order data.....	151
Table 69:	0TB103.9, 0TB103.91 - Technical data.....	151
Table 70:	0TB103.8 - Order data.....	153
Table 71:	0TB103.8 - Technical data.....	153
Table 72:	5AC900.104X-03, 5AC900.104X-04, 5AC900.104X-05, 5AC900.150X-01 - Order data.....	154
Table 73:	5CADVI.0018-00, 5CADVI.0050-00, 5CADVI.0100-00 - Order data.....	155
Table 74:	5CADVI.0018-00, 5CADVI.0050-00, 5CADVI.0100-00 - Technical data.....	155
Table 75:	5CASDL.0018-00, 5CASDL.0050-00, 5CASDL.0100-00, 5CASDL.0150-00, 5CASDL.0200-00, 5CASDL.0250-00, 5CASDL.0300-00 - Order data.....	158
Table 76:	5CASDL.0018-00, 5CASDL.0050-00, 5CASDL.0100-00, 5CASDL.0150-00, 5CASDL.0200-00, 5CASDL.0250-00, 5CASDL.0300-00 - Technical data.....	158
Table 77:	5CASDL.0018-01, 5CASDL.0050-01, 5CASDL.0100-01, 5CASDL.0150-01 - Order data.....	161
Table 78:	5CASDL.0018-01, 5CASDL.0050-01, 5CASDL.0100-01, 5CASDL.0150-01 - Technical data..	161
Table 79:	5CASDL.0018-03, 5CASDL.0050-03, 5CASDL.0100-03, 5CASDL.0150-03, 5CASDL.0200-03, 5CASDL.0250-03, 5CASDL.0300-03 - Order data.....	164
Table 80:	5CASDL.0018-03, 5CASDL.0050-03, 5CASDL.0100-03, 5CASDL.0150-03, 5CASDL.0200-03, 5CASDL.0250-03, 5CASDL.0300-03 - Technical data.....	164
Table 81:	5CASDL.0xxx-03 SDL flex cables - Structure.....	166
Table 82:	5CASDL.0300-13, 5CASDL.0400-13, 5CASDL.0430-13 - Order data.....	167
Table 83:	5CASDL.0300-13, 5CASDL.0400-13, 5CASDL.0430-13 - Technical data.....	167
Table 84:	5CASD3.0100-00, 5CASD3.0150-00, 5CASD3.0200-00, 5CASD3.0300-00, 5CASD3.0500-00, 5CASD3.1000-00 - Order data.....	171
Table 85:	5CASD3.0100-00, 5CASD3.0150-00, 5CASD3.0200-00, 5CASD3.0300-00, 5CASD3.0500-00, 5CASD3.1000-00 - Technical data.....	171
Table 86:	5CAUSB.0018-00, 5CAUSB.0050-00 - Order data.....	174
Table 87:	5CAUSB.0018-00, 5CAUSB.0050-00 - Technical data.....	174
Table 88:	9A0014.02, 9A0014.05, 9A0014.10 - Order data.....	175
Table 89:	9A0014.02, 9A0014.05, 9A0014.10 - Technical data.....	175
Table 90:	5AC900.1200-00 - Order data.....	177
Table 91:	5AC900.1200-01 - Order data.....	177
Table 92:	5AC900.1201-00 - Order data.....	177
Table 93:	5AC900.1201-01 - Order data.....	178
Table 94:	5MMUSB.2048-00 - Order data.....	179
Table 95:	5MMUSB.2048-00 - Technical data.....	179
Table 96:	5MMUSB.2048-01, 5MMUSB.4096-01 - Order data.....	181
Table 97:	5MMUSB.2048-01, 5MMUSB.4096-01 - Technical data.....	181
Table 98:	Overview of fluorescents tubes and panels.....	183
Table 99:	9A0110.18, 9A0110.22 - Order data.....	183
Table 100:	5AC804.MFLT-00 - Order data.....	184
Table 101:	5AC804.MFLT-00 - Technical data.....	184
Table 102:	5SWHMI.0000-00 - Order data.....	186
Table 103:	Elo AccuTouch screen - Technical data.....	194
Table 104:	5-wire AMT touch screen - Technical data.....	196
Table 105:	Chemical resistance of the panel overlay.....	198
Table 106:	Product abbreviations.....	200
Table 107:	Overview of device compatibility.....	200

0TB103.8.....	153
0TB103.9.....	151
0TB103.91.....	151
5AC804.MFLT-00.....	184
5AC900.104X-03.....	154
5AC900.104X-04.....	154
5AC900.104X-05.....	154
5AC900.1200-00.....	177
5AC900.1200-01.....	177
5AC900.1201-00.....	177
5AC900.1201-01.....	178
5AC900.150X-01.....	154
5AP920.1043-01.....	28
5AP920.1214-01.....	57
5AP920.1505-01.....	146
5AP920.1706-01.....	83
5AP920.1906-01.....	146
5AP920.2138-01.....	93
5AP951.1043-01.....	32
5AP951.1505-01.....	67
5AP952.1043-01.....	37
5AP980.1043-01.....	42
5AP980.1505-01.....	72
5AP981.1043-01.....	48
5AP981.1505-01.....	78
5AP982.1043-01.....	52
5CADVI.0018-00.....	155
5CADVI.0050-00.....	155
5CADVI.0100-00.....	155
5CASD3.0100-00.....	171
5CASD3.0150-00.....	171
5CASD3.0200-00.....	171
5CASD3.0300-00.....	171
5CASD3.0500-00.....	171
5CASD3.1000-00.....	171
5CASDL.0018-00.....	158
5CASDL.0018-01.....	161
5CASDL.0018-03.....	164
5CASDL.0050-00.....	158
5CASDL.0050-01.....	161
5CASDL.0050-03.....	164
5CASDL.0100-00.....	158
5CASDL.0100-01.....	161
5CASDL.0100-03.....	164
5CASDL.0150-00.....	158
5CASDL.0150-01.....	161
5CASDL.0150-03.....	164
5CASDL.0200-00.....	158
5CASDL.0200-03.....	164
5CASDL.0250-00.....	158
5CASDL.0250-03.....	164
5CASDL.0300-00.....	158
5CASDL.0300-03.....	164
5CASDL.0300-13.....	167
5CASDL.0400-13.....	167
5CASDL.0430-13.....	167
5CAUSB.0018-00.....	174
5CAUSB.0050-00.....	174
5DLDVI.1000-01.....	146
5DLSD3.1000-00.....	105
5DLSDL.1000-00.....	101
5DLSDL.1000-01.....	146

5MMUSB.2048-00.....	179
5MMUSB.2048-01.....	181
5MMUSB.4096-01.....	181
5SWHMI.0000-00.....	186
9A0014.02.....	175
9A0014.05.....	175
9A0014.10.....	175
9A0110.18.....	183
9A0110.22.....	183

A

Abbreviation.....	200
Accessories.....	151
ADI.....	137
.NET SDK.....	141
Development Kit.....	139
Automation Panel	
Minimum ambient temperature during operation.....	20
Automation Panel Link plug-in cards.....	97

B

B&R Automation Device Interface.....	137
B&R Control Center.....	137
B&R Key Editor.....	143
Backlight.....	136
Block diagrams.....	23

C

Cable drag chain.....	150
Cable lengths.....	123, 125
Cables.....	155
DVI.....	155
RS232.....	175
SDL.....	158
SDL3.....	171
SDL flex.....	164
SDL flex cables with extender.....	167
SDL with 45° male connector.....	161
USB.....	174
CE mark.....	145
Certifications.....	146
Germanischer Lloyd.....	146
certifications	
GOST-R.....	146
Certifications	
UL.....	146
Chemical resistance.....	198
Cleaning.....	189, 195, 196
climate-controlled chamber.....	118
COM.....	100, 100
Complete system.....	18
Connection examples.....	119
Control Center.....	115, 137
Creating reports.....	138

D

dead/stuck pixels.....	136
defective pixels.....	136
Dimension standards.....	14
Display units.....	27
Disposal.....	13, 13
DVI cables.....	155

E

Electromagnetic compatibility.....	145
EMC directive.....	145

ESD.....	11
Electrical components with a housing.....	11
Electrical components without a housing.....	11
Individual components.....	11
Packaging.....	11
evaluate the temperature.....	116
Evaluating temperatures.....	115
example programs.....	118
F	
fluorescent tubes.....	183
G	
General tolerance.....	14
Germanischer Lloyd.....	146
GL certification.....	146
GOST-R.....	146
Gosudarstwenny standard.....	146
Guidelines.....	14
H	
HMI Drivers & Utilities DVD.....	186
Humidity specifications.....	21
I	
implementation guide.....	118
Installation	
with clamping blocks.....	109
Interfaces	
SDL3 In.....	106
USB.....	107
K	
Key and LED configurations.....	131
Key Editor.....	143
L	
LEDs.....	107
Legend strip templates.....	154
Line filter.....	184
loopback plug.....	117
Low voltage directive.....	145
M	
Manual history.....	8
Maximum ambient temperature.....	19
Mounting compatibility.....	200
Mounting orientation	
0°.....	111
45°.....	111
P	
Panel overlay.....	198

Peripheral USB devices.....	128
Power connectors.....	151
Power consumption.....	22
Product abbreviations.....	200
Proper ESD handling.....	11

R

Relative humidity.....	21
Replacing the fluorescent tubes.....	190
RS232 cables.....	175

S

Safety guidelines.....	11
Environmental conditions.....	12
Environmentally friendly disposal.....	13
Installation.....	12
Intended use.....	11
Operation.....	12
Policies and procedures.....	11
Protection against electrostatic discharge.....	11
Separation of materials.....	13
Transport and storage.....	12
Screen burn-in.....	136, 136
SDL3 cables.....	171
SDL3 In interface.....	106
SDL3 In LEDs.....	107
SDL3 mode.....	105
SDL3 operation with SDL3 transmitter.....	105
SDL3 resolution.....	126
SDL cables.....	158
SDL cables with 45° male connector.....	161
SDL flex cables.....	164
SDL flex cables with extender.....	167
SDL resolution.....	123, 125
SDL transmission.....	123, 125, 123, 125
Serial interface.....	100
serial number sticker.....	26
service life of the display.....	136
software versions.....	138
spacing.....	113
Spacing for air circulation.....	113
Standards and guidelines.....	145
supply voltage.....	100, 102, 104, 108

T

temperature testing.....	115
Temperature testing instructions.....	115
Temperature testing procedure.....	115
Terminal blocks.....	153
Torsion.....	149
Touch screen calibration.....	135

U

UL certification.....	146
USB 2.0.....	107
USB cables.....	174

USB flash drive.....	179
USB interface.....	107
user serial ID.....	138

V

Video signal.....	106
Viewing angles.....	199