

CL200

CL200 Manual

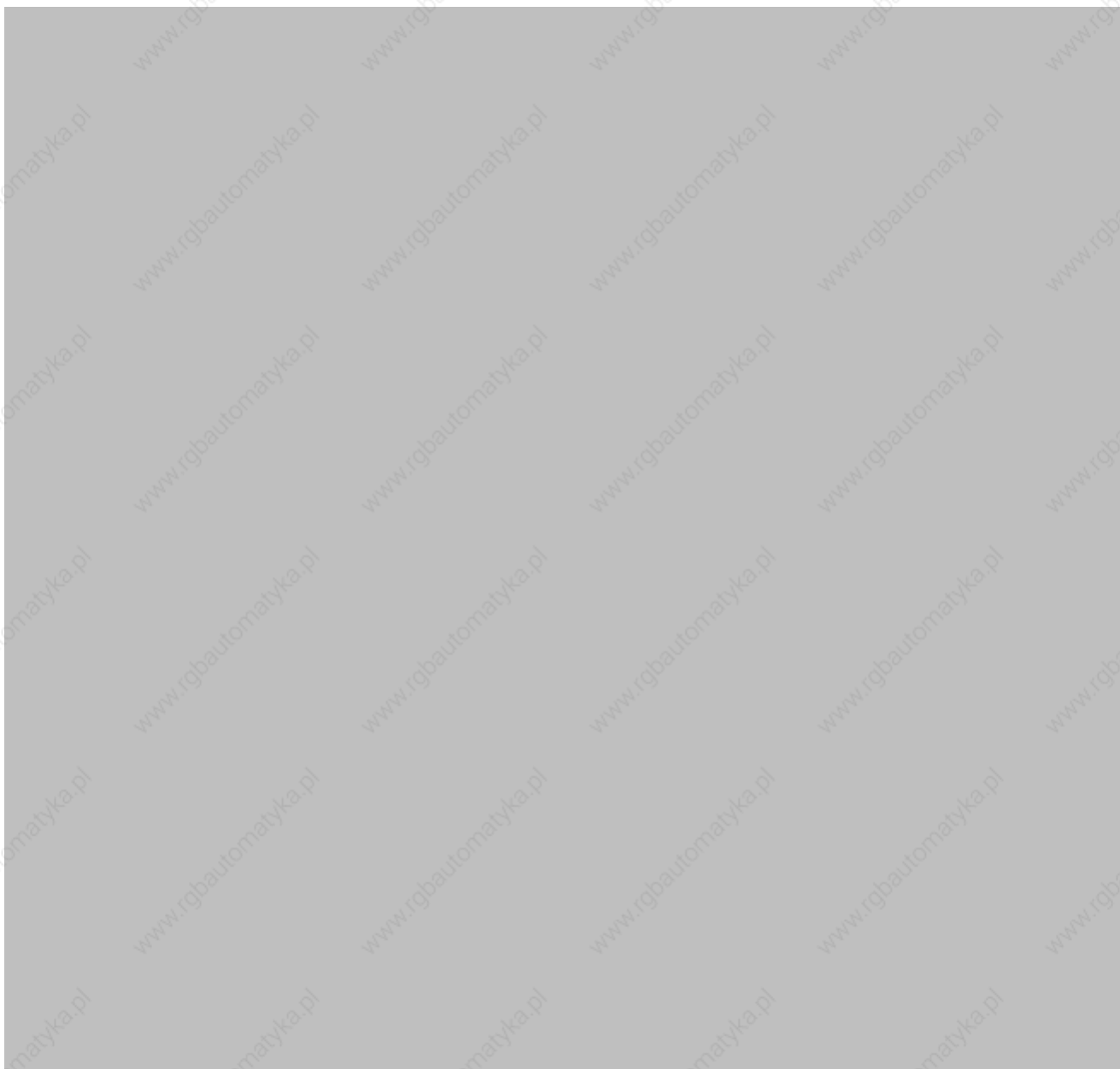

Edition

102



BOSCH
Automation

CL200

CL200 Manual

1070 072 145-102 (01.07) GB



© 1995 – 2001

by Robert Bosch GmbH, Erbach / Germany
All rights reserved, including applications for protective rights.
Reproduction or distribution by any means subject to our prior written permission.

Discretionary charge 20.– DM

Contents

	Page
1	Safety Instructions 1–1
1.1	Intended use 1–1
1.2	Qualified personnel 1–2
1.3	Safety markings on components 1–3
1.4	Safety instructions in this manual 1–4
1.5	Safety instructions for the described product 1–5
1.6	Documentation, software release and trademarks 1–7
2	System Introduction 2–1
2.1	Features and Functions 2–1
2.1.1	UL-Certification 2–3
2.2	Programming 2–4
2.3	CL200 Specifications 2–5
2.4	Module slots 2–7
3	Module Racks 3–1
3.1	Overview 3–1
3.2	Assembly 3–2
3.3	Basic Unit 3–5
3.4	Expansion Unit 3–6
3.4.1	Expansion Structure 3–8
4	NT200 Power Supply Module 4–1
4.1	Features and Functions 4–1
4.2	Display and Control Elements 4–3
4.3	Memory Backup Battery 4–5
4.4	Specifications 4–7
5	Central Processing Unit 5–1
5.1	Features and Functions 5–1
5.2	Display and Control Elements 5–5
5.3	MemoryCard 5–9
5.4	Interfaces 5–10
5.4.1	Interface Connections 5–10
5.4.2	X71 Interrupt and High-speed Counter Inputs 5–11
5.4.3	X72 Analog Inputs and Outputs 5–15
5.4.4	X31 Interface for PG Programming Unit 5–19
5.4.5	X32 Second Serial Interface 5–22
5.4.6	X73 PROFIBUS-DP Interface 5–24
5.5	Operating modes 5–27
5.6	Reloading the Firmware 5–28
5.7	Specifications 5–29
6	E 24 V– Digital Input Modules 6–1
6.1	Features and Functions 6–1
6.2	Connection 6–3
6.3	Specifications 6–5

7	Digital Output Modules	7-1
7.1	Features and Functions	7-1
7.2	Connections and Settings	7-2
7.3	A 24 V- Output Module / 0.5 A (16-way and 32-way)	7-5
7.4	A 24 V- / 2 A Output Module	7-7
7.5	AR/2A Relay Output module	7-7
7.6	Specifications	7-10
8	Digital Input/Output Modules	8-1
8.1	Functions and Features	8-1
8.2	Addressing	8-3
8.3	Connection	8-4
8.3.1	X10 Power Terminals	8-4
8.3.2	X21A, X22A Inputs	8-4
8.3.3	X11B, X12B Outputs	8-6
8.4	Specifications	8-8
9	DP-EA4 Peripheral Bus Station Module	9-1
9.1	Features and Functions	9-1
9.2	Display and Control Elements, Connections and Settings	9-3
9.3	Specifications	9-5
10	AG/S Expansion Module	10-1
10.1	Features and Functions	10-1
10.2	Specifications	10-3
11	R200, R200P, COM2-E Communication Modules .	11-1
11.1	Functions and Features	11-1
11.1.1	R200 Communication Module	11-2
11.1.2	R200P Communication Module	11-3
11.1.3	COM2-E Communication Module	11-4
11.2	Specifications	11-6
11.3	Advanced Documentation	11-7
12	Analog Input Modules	12-1
12.1	Features and Functions	12-1
12.1.1	E ana Analog Input Module	12-2
12.1.2	E20 ana Analog Input Module	12-3
12.2	Specifications	12-3
12.3	Advanced Documentation	12-4
13	Analog Output Modules	13-1
13.1	Features and Functions	13-1
13.1.1	A ana Analog Output Module	13-2
13.1.2	A10 ana Analog Output Module	13-2
13.1.3	A20 ana Analog Output Module	13-2
13.2	Specifications	13-3
13.3	Advanced Documentation	13-4

14	Positioning Modules	14-1
14.1	Features and Function	14-1
14.1.1	POS-SA1 and POS-SA2 counting / positioning modules	14-2
14.1.2	POS-LR1 and POS-LR2 positioning modules	14-3
14.2	Specifications	14-4
14.3	Advanced Documentation	14-4
15	BM2-ASI Bus Master	15-1
15.1	Features and Functions	15-1
15.2	Specifications	15-2
15.3	Advanced Documentation	15-2
16	RM2-DP12 Module	16-1
16.1	Features and Functions	16-1
16.2	Connecting to PROFIBUS-DP	16-2
16.3	Display and Control Elements	16-3
16.4	Specifications	16-4
16.5	Advanced Documentation	16-4
17	Installation	17-1
17.1	External Power Supply	17-1
17.2	24 V Power Supply	17-2
17.2.1	Hardware Configuration w/o Electrical Isolation	17-2
17.2.2	Hardware Configuration w/ Electrical Isolation	17-3
17.2.3	Reference Conductor Connected to Protective Earth	17-4
17.2.4	Reference Conductor Not Connected to PE Conductor	17-5
17.2.5	Programming Unit and Earthing	17-5
17.2.6	Capacitive Load in Power Supply Network	17-6
17.2.7	Dimensioning Power Cables	17-7
17.2.8	Master Switch	17-7
17.2.9	Fuses	17-7
17.2.10	Earthing	17-9
17.3	Electromagnetic Compatibility (EMC)	17-10
17.3.1	Interference	17-10
17.3.2	Signal-to-Noise Ratio	17-10
17.3.3	EMC Directive and CE Label	17-11
17.3.4	EMC Characteristics of the CL200	17-11
17.3.5	Installation Procedures Ensuring Interference Resistance	17-13
A	Appendix	A-1
A.1	Index	A-1

Notes:

1 Safety Instructions

Before you start working with the CL200 Controller, we recommend that you thoroughly familiarize yourself with the contents of this manual. Keep this manual in a place where it is always accessible to all users.

1.1 Intended use

This instruction manual presents a comprehensive set of instructions and information required for the standard operation of the described products.

The products described hereunder

- were developed, manufactured, tested and documented in accordance with the relevant safety standards. In standard operation, and provided that the specifications and safety instructions relating to the project phase, installation and correct operation of the product are followed, there should arise no risk of danger to personnel or property.
- are certified to be in full compliance with the requirements of
 - the EMC Directives (89/336/EEC, 93/68/EEC and 93/44/EEC)
 - the Low-Voltage Directive (73/23/EEC)
 - the harmonized standards EN 50081-2 and EN 50082-2
- are designed for operation in an industrial environment (Class A emissions). The following restrictions apply:
 - No direct connection to the public low-voltage power supply is permitted.
 - Connection to the medium and/or high-voltage system must be provided via transformer.

The following applies for application within a personal residence, in business areas, on retail premises or in a small-industry setting:

- Installation in a control cabinet or housing with high shield attenuation.
- Cables that exit the screened area must be provided with filtering or screening measures.
- The user will be required to obtain a single operating license issued by the appropriate national authority or approval body.

 **This is a Class A device. In a residential area, this device may cause radio interference. In such case, the user may be required to introduce suitable countermeasures, and to bear the cost of the same.**

Proper transport, handling and storage, placement and installation of the product are indispensable prerequisites for its subsequent flawless service and safe operation.

1.2 Qualified personnel

This instruction manual is designed for specially trained personnel. The relevant requirements are based on the job specifications as outlined by the ZVEI and VDMA professional associations in Germany. Please refer to the following German-Language publication:

Weiterbildung in der Automatisierungstechnik
Publishers: ZVEI and VDMA Maschinenbau Verlag
Postfach 71 08 64
60498 Frankfurt/Germany

This instruction manual addresses specially trained personnel possessing in-depth knowledge of Programmable Logic Controllers.

Interventions in the hardware and software of our products not described in this instruction manual may only be performed by our skilled personnel.

Unqualified interventions in the hardware or software or non-compliance with the warnings listed in this instruction manual or indicated on the product may result in serious personal injury or damage to property.

Installation and maintenance of the products described hereunder is the exclusive domain of trained electricians as per IEV 826-09-01 (modified) who are familiar with the contents of this manual.

Trained electricians are persons of whom the following is true:

- They are capable, due to their professional training, skills and expertise, and based upon their knowledge of and familiarity with applicable technical standards, of assessing the work to be carried out, and of recognizing possible dangers.
- They possess, subsequent to several years' experience in a comparable field of endeavour, a level of knowledge and skills that may be deemed commensurate with that attainable in the course of a formal professional education.

With regard to the foregoing, please read the information about our comprehensive training program. The professional staff at our training centre will be pleased to provide detailed information. You may contact the centre by telephone at (+49) 6062 78-258.

1.3 Safety markings on components



DANGER! High voltage!



DANGER! Corrosive battery acid!



CAUTION! Electrostatically sensitive devices (ESD)!



Disconnect mains power before opening!



Lug for connecting PE conductor only!



Functional earthing or low-noise earth only!



Screened conductor only!

1.4 Safety instructions in this manual



DANGEROUS ELECTRICAL VOLTAGE

This symbol warns of the presence of a **dangerous electrical voltage**. Insufficient or lacking compliance with this warning can result in **personal injury**.



DANGER

This symbol is used wherever insufficient or lacking observance of this instruction can result in **personal injury**.



CAUTION

This symbol is used wherever insufficient or lacking observance of instructions can result in **damage to equipment or data files**.

 This symbol is used to alert the user to an item of special interest.

★ This asterisk symbol indicates that the manual is describing an activity which the user will be required to perform.

1.5 Safety instructions for the described product

**DANGER**

Fatal injury hazard through ineffective Emergency-STOP devices! Emergency-STOP safety devices must remain effective and accessible during all operating modes of the system. The release of functional locks imposed by Emergency-STOP devices must never be allowed to cause an uncontrolled system restart! Before restoring power to the system, test the Emergency-STOP sequence!

**DANGER**

Danger to persons and equipment!
Test every new program before operating the system!

**DANGER**

Retrofits or modifications may interfere with the safety of the products described hereunder!
The consequences may be severe personal injury or damage to equipment or the environment. Therefore, any system retrofitting or modification utilizing equipment components from other manufacturers will require express approval by Bosch.

**DANGEROUS ELECTRICAL VOLTAGE**

Unless described otherwise, maintenance procedures must always be carried out only while the system is isolated from the power supply. During this process, the system must be blocked to prevent an unauthorized or inadvertent restart.

If measuring or testing procedures must be carried out on the active system, these must be carried out by trained electricians.

**CAUTION**

Danger to the module!
Do not insert or remove the module while the controller is switched ON! This may destroy the module. Prior to inserting or removing the module, switch OFF or remove the power supply module of the controller, external power supply and signal voltage!

**CAUTION**

Only Bosch-approved spare parts may be used!

**CAUTION****Danger to the module!****All ESD protection measures must be observed when using the module! Prevent electrostatic discharges!**

Observe the following protective measures for electrostatically sensitive devices (ESD)!

- The personnel responsible for storage, transport and handling must be trained in ESD protection.
- ESDs must be stored and transported in dedicated protective packaging.
- Out of principle, ESDs may be handled only at special ESD workstations equipped for this particular purpose.
- Personnel, work surfaces and all devices and tools that could come into contact with ESDs must be on the same potential (e.g., earthed).
- An approved earthing wrist strap must be worn. It must be connected to the work surface via a cable with integrated 1 M Ω resistor.
- ESDs may under no circumstances come into contact with objects susceptible to accumulating an electrostatic charge. Most items made of plastic belong to this category.
- When installing ESDs in or removing them from an electronic device, the power supply of the device must be switched OFF.

1.6 Documentation, software release and trademarks

Relevant documentation

The present manual provides comprehensive information about the CL200 Controller and its accessories.

Programming information is not included in the manual.

Overview of available manuals:

Overview of available documentation	Order no.			
	German	English	French	Spanish
Die Welt der SPS	1070 072 407	–	–	–
Manual	1070 072 091	1070 072 145	1070 072 213	1070 072 336
Operations List	1070 072 090	1070 072 151	1070 072 214	1070 072 337
SFC Sequence Function Chart	1070 072 402	1070 072 186	–	1070 072 342
KETTE200	1070 072 092	1070 072 150	1070 072 218	1070 072 338
BT-MADAP	1070 072 096	1070 072 163	–	–
R200	1070 072 400	1070 072 157	–	–
R200P	1070 072 401	1070 072 162	–	–
BM2-ASI	1070 072 442	1070 072 194	–	–
E ana, E20 ana	1070 072 408	1070 072 164	–	–
A ana, A10 ana	1070 072 409	1070 072 165	–	–
POS-SA1, POS-SA2	1070 072 405	1070 072 169	–	–
POS-LR1, POS-LR2	1070 072 424	1070 072 191	–	–
BT20-Bedienoberfläche für POS-LR	1070 072 429	–	–	–
RM2-DP12	1070 072 448	1070 072 449	–	–
Control Terminal BT2 / BT5N / BT20N	1070 083 628	1070 083 630	–	–

Trademarks

All trademarks referring to software that is installed on Bosch products when shipped from the factory represent the property of their respective owners.

At the time of shipment from the factory, all installed software is protected by copyright. Software may therefore be duplicated only with the prior permission of the respective manufacturer or copyright owner.

MS-DOS® and Windows™ are registered trademarks of Microsoft Corporation.

PROFIBUS® is a registered trademark of the PROFIBUS Nutzerorganisation e.V. (user organization).

MOBY® is a registered trademark of Siemens AG.

AS-I® is a registered trademark of AS-International Association.

INTERBUS-S® is a registered trademark of Phoenix Contact.

DeviceNet® is a registered trademark (TM) of ODVA (Open DeviceNet Vendor Association, Inc.).

The UL Mark is a registered certification mark of Underwriters Laboratories, Inc., an independent, not-for-profit product safety testing and certification organization.

2 System Introduction

2.1 Features and Functions



The CL200 is a powerful controller system of compact and modular design.

Application areas

In its minimum configuration, the CL200 facilitates cost efficient deployment even in the smallest machine compounds. When fully configured with all available options or deployed as a decentralized controller in a networked situation, it can handle partial tasks in transfer lines.

Thanks to its networking option and extensive command repertoire, the CL200 is also capable of assuming controller tasks of the medium performance category.

- Packaging machines
- Conveyor technology
- Building automation
- Bottling equipment and racking plants
- Heating, climate control, ventilation and environmental technologies
- Subsections of transfer line construction
- assembly and handling technologies
- Food processing industry
- General applications in mechanical engineering

Performance range

With 7 different central processing units, the CL200 allows accurate fine-tuning of the controller performance to task related requirements.

- ZE200
Cost effective variant for small and high-speed controller tasks.
 - 2 high-speed 32-bit counters
 - 3 interrupt inputs
 - Centralized system clock
 - Function modules for sequential control and diagnostics
- ZE200A
Similar to ZE200, plus
 - 4 analog inputs
 - 1 analog output
- ZE200M
Similar to ZE200, plus
 - MemoryCard
- ZE200AM
Range of functions as on ZE200A and ZE200M
- ZE201
Similar to ZE200, plus
 - Second serial interface (COM port)
- ZE200-DP
Similar to ZE200, plus
 - Bus master for COMNET-DP
- ZE200A-DP
Range of functions as on ZE200-DP and ZE200A

Hardware configuration

The minimum configuration of the CL200 consists of the following:

- One GG3 or GG3-K module rack
- One NT200 power supply module
- One central processing unit

Functional extension is possible by inserting additional peripheral modules (intelligent modules or I/O modules).

In the event that more peripheral modules are required, additional modules can be installed in expansion units.

2.1.1 UL-Certification



The CL200 hardware modules are Underwriters Laboratories (UL) certified for operation in the United States and Canada. The modules are listed in the “Product Identity 17YB”.

Designation		Order no.	Described in
Input module E 24 V– 16-way	w/ spring loaded terminals	1070 083 383	Chapter 6
Input module E 24 V– 32-way	w/ spring loaded terminals	1070 083 384	
Input module, analog E20 ana	w/ spring loaded terminals	1070 079 455	Chapter 12 and separate manual (see page 1–7)
Output module A 24 V– / 2 A, 8-way	w/ spring loaded terminals	1070 083 385	Chapter 7
Output module A 24 V– / 0.5 A, 16-way	w/ spring loaded terminals	1070 083 386	
Output module A 24 V– / 0.5 A, 32-way	w/ spring loaded terminals	1070 083 387	
I/O module E16/A16-0.5 A	w/ spring loaded terminals	1070 079 452	Chapter 8
Output module, analog A10 ana (4 channels)	w/ spring loaded terminals	1070 079 454	Chapter 13 and separate manual (see page 1–7)
Output module, analog A10 ana (8 Channels)	w/ spring loaded terminals	1070 079 453	
BM2-ASI, AS interface bus master		1070 078 284	Chapter 15 and separate manual (see page 1–7)
RM2-DP12, remote module		1070 075 814	Chapter 16 and separate manual (see page 1–7)

☞ **As a prerequisite for UL approved application, the following connecting cables are required:**

- **Copper cables rated up to 60/75 °C**
- **Only Class 1 or similar cables**

2.2 Programming

The CL200 is programmed with the aid of a PC via the serial COM port. With the use of the PC, the PLC program can also be written without requiring the physical presence of the controller.

The CL200 provides the following options for storing the PLC program:

- Battery backed RAM memory
- Flash EPROM memory
- MemoryCard

Program Structure

The PLC program is subdivided into clearly defined and technologically allocated program modules.

Programming

The PLC program is produced with the use of the Bosch proprietary WinSPS software application.

The PLC program can be produced in the form of

- IL instruction list
- LD ladder diagram
- FUD function diagram
- SFC sequential function chart

with optional use of symbolic or absolute operands.

The programming language is based on DIN 19239.

PLC program documentation

The clearly structured and easily understood PLC program documentation providing cross-reference lists supports the user in the case of quick system startup, system troubleshooting, or when adapting the controller to new applications.



Both in the form of the screen display of the programming unit and as hard-copy, the PLC program documentation provides a substantial rate of comments.

2.3 CL200 Specifications

- ☞ **The Specifications as stated below apply to operation without the MemoryCard. Operating with the MemoryCard requires additional observation of the operating conditions issued by the manufacturer.**

- ☞ **The CL200 controller is a Class A device. It is designated for deployment in an industrial setting. When operated in private residences, in business or small-industry settings, the CL200 may cause radio interference. In such case, the user will be required to introduce suitable preventive radio interference countermeasures. Such measures include the introduction of additional screening and filters. The user will be required to obtain a single operating license issued by the appropriate national authority or approval body.**

Specifications	CL200
Complies w/ applicable laws/standards	<ul style="list-style-type: none"> ● EMC Directive of 9.11.1992 ● EN 50081-2 ● EN 61131-2 ● EN 60204-1 ● EN 50178 ● EN 60529
Power supply	NT200 power supply module, 24 VDC, (19.2 thru 30 V)
Bridging capability, input power intermittents on NT200 power supply module, as per EN 61131-2	Class PS2 ≤ 10 ms, repetition rate ≥ 1 s
Current draw, from 24-V power supply <ul style="list-style-type: none"> ● Nominal current ● Minimum HW configuration: NT200, ZE200A, 16 inputs, 16 outputs 	1.8 A typ. 220 mA
Interference emission when properly installed in module rack <ul style="list-style-type: none"> ● Housing, radio interference suppression as per EN 50081-2 	Class A <ul style="list-style-type: none"> ● Frequency 30 thru 230 MHz; imit. value 30 dB (μV/m) at 30 m ● Frequency 230 thru 1000 MHz; limit value 37 dB (μV/m) at 30 m
Interference resistance when properly installed in module rack <ul style="list-style-type: none"> ● high-frequency electromagnetic fields, as per EN 61131-2 ● electrostatic discharge on exposed housing components, w/o MemoryCard <ul style="list-style-type: none"> ● as per EN 61131-2 	Test field strength 10 V/m Frequency range 27 thru 500 MHz Sweep rate 0.0015 Dec/s EMI resistance 4 for moisture class RH-2 <ul style="list-style-type: none"> ● Air gap discharge 15 kV ● Contact discharge 4 kV

Specifications	CL200
<ul style="list-style-type: none"> Line transient interference <ul style="list-style-type: none"> Rapid burst pulses, symm., as per EN 61131-2 Dampened sinewave 1 MHz, symm., as per EN 61131-2 	<ul style="list-style-type: none"> 2 kV for power supply module and digital inputs/outputs 1 kV for analog inputs / outputs, counter and interrupt inputs, serial interfaces 1 kV for <ul style="list-style-type: none"> NT200 power supply module Digital inputs / outputs All power supply connections on modules
Insulation test voltage, as per EN 61131-2	<ul style="list-style-type: none"> 350 V, AC voltage 500 V, DC voltage 500 V Pulse, 1.2 / 50 μs
Shock and vibration resistance <ul style="list-style-type: none"> Sinewave-shaped oscillations on X, Y and Z axes, to EN 61131-2 Shock loads on X, Y, and Z axes, as per EN 61131-2 	<ul style="list-style-type: none"> 10 thru 57 Hz <ul style="list-style-type: none"> 0.0375 mm amplitude, contin. 0.075 mm amplitude, occas. 57 thru 150 Hz <ul style="list-style-type: none"> 0.5 g, continuous 1 g, occasional 11 ms semi-sinewave 15 g
Corrosion, chemical resistance	The ambient air must be free of elevated concentrations of acids, alkali, corrosives, salts, metallic vapours, or other electrically conductive pollutants.
Pollution level, as per VDE 0110 Part1	2 The ambient air must be dust-free. Housing and installation environments accommodating the module rack must comply with IP 54.
Protection category, as per EN 60529	IP 20
Safety class, as per EN 50178	Class I
Humidity rating, as per EN 61131-2	RH-2, 5 through 95 %, condensation not permitted
Operating temperature range, as per EN 61131-2, w/o battery and MemoryCard*) <ul style="list-style-type: none"> Horizontal installation  Vertical installation  	<ul style="list-style-type: none"> 5 to +55 °C 5 to +40 °C
Storage temperature range, as per EN 61131-2	-25 to +70 °C, w/o battery and MemoryCard*)
Atmospheric pressure, as per EN 61131-2	Operation up to 2000 m above sea level
Transportability, as per EN 61131-2	Drop height, in package 1 m

Specifications	CL200
Weight, GG3 module rack	<ul style="list-style-type: none"> • Net weight, 1kg • Fully populated, approx. 3 kg
Weight, GG3-K module rack	<ul style="list-style-type: none"> • Net weight, 0.58 kg • Fully populated, approx. 1.8 kg
Dimensions, GG3 , w/ population in mm (B x H x T)	224 x 184 x 126
Dimensions, GG3-K, w/ population in mm (B x H x T)	132 x 184 x 126

*) Battery and MemoryCard are subject to the specification of the respective manufacturer.

 **The backplane must always be in a vertical position.**

2.4 Module slots

The module descriptions list the usable module slots for the module racks of both basic unit and expansion unit. Usable module slots are shown in grey in the diagram below.

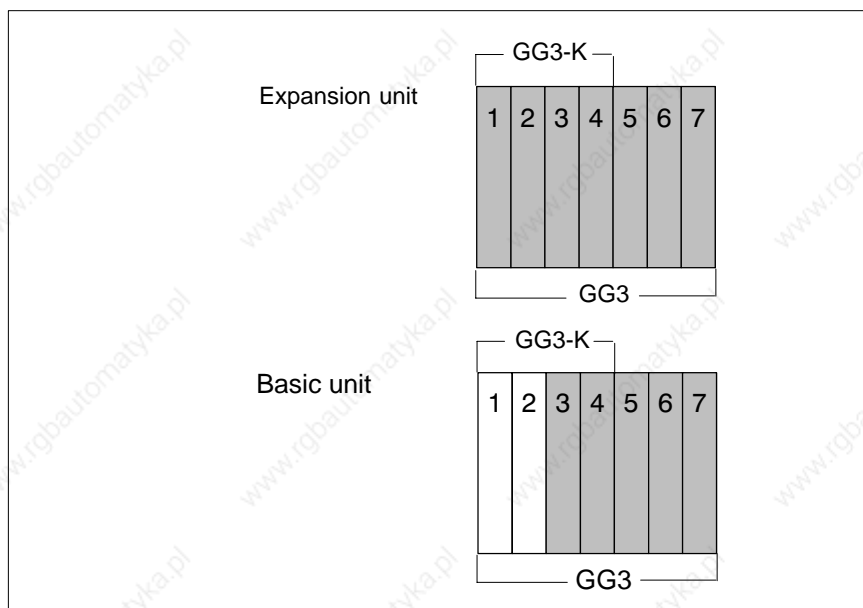

Notes:

3 Module Racks

3.1 Overview

For the basic and expansion units, the following module racks are available:

- GG3 w/ 7 module slots
- GG3-K w/ 4 module slots

Both module racks consist of a metal housing.

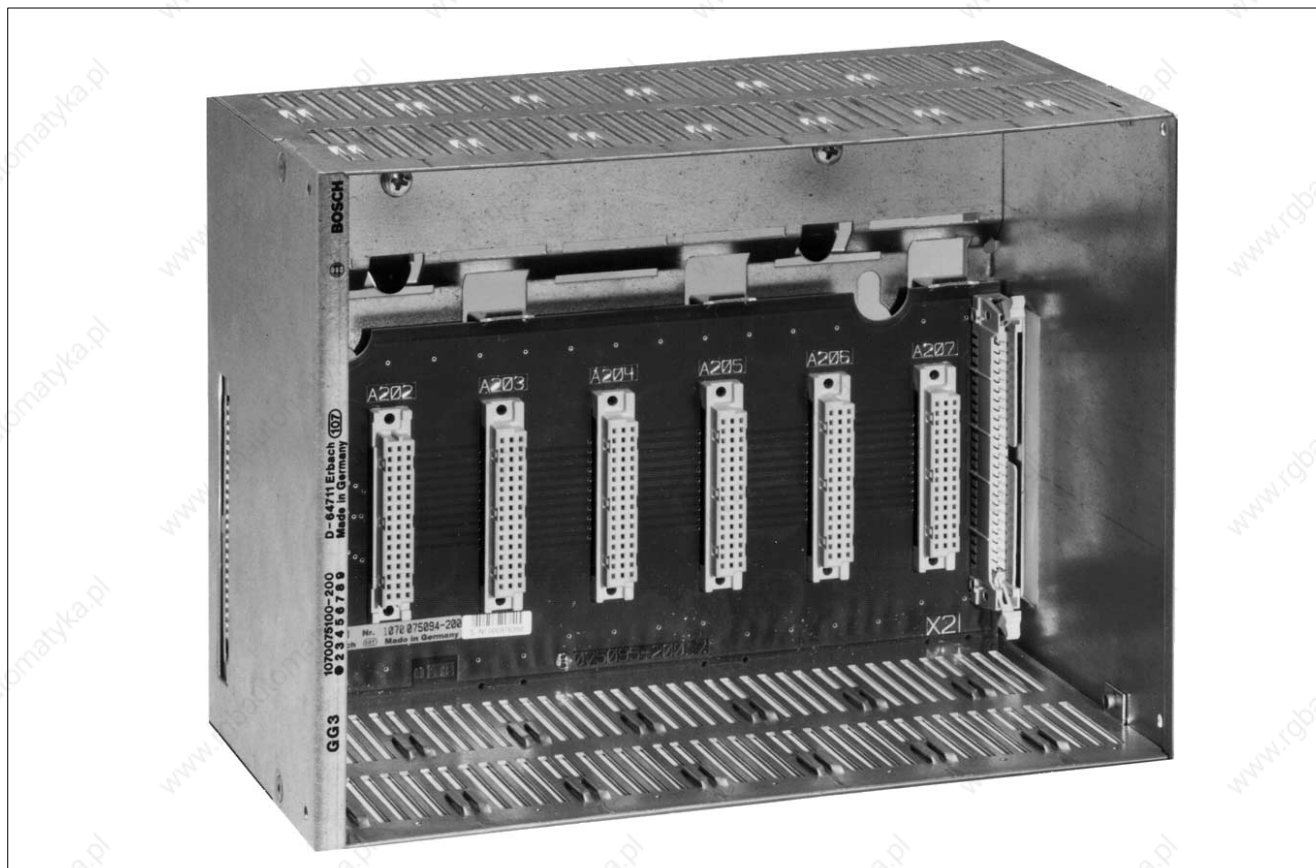

The modules are inserted into the slot guide rails inside the module rack and then pressed home until properly seated.

The tight contact between module and module rack thus achieved provides for a high degree of mechanical stiffness while at the same time ensuring increased resistance against external electrical interference.

 **Empty slots must be closed with dummy covers.**

Ordering information

Designation	Order no.
GG3 Module rack	1070 075 100
GG3-K Module rack	1070 079 961
Locking foot, for support rail assembly	1070 077 225

3.2 Assembly

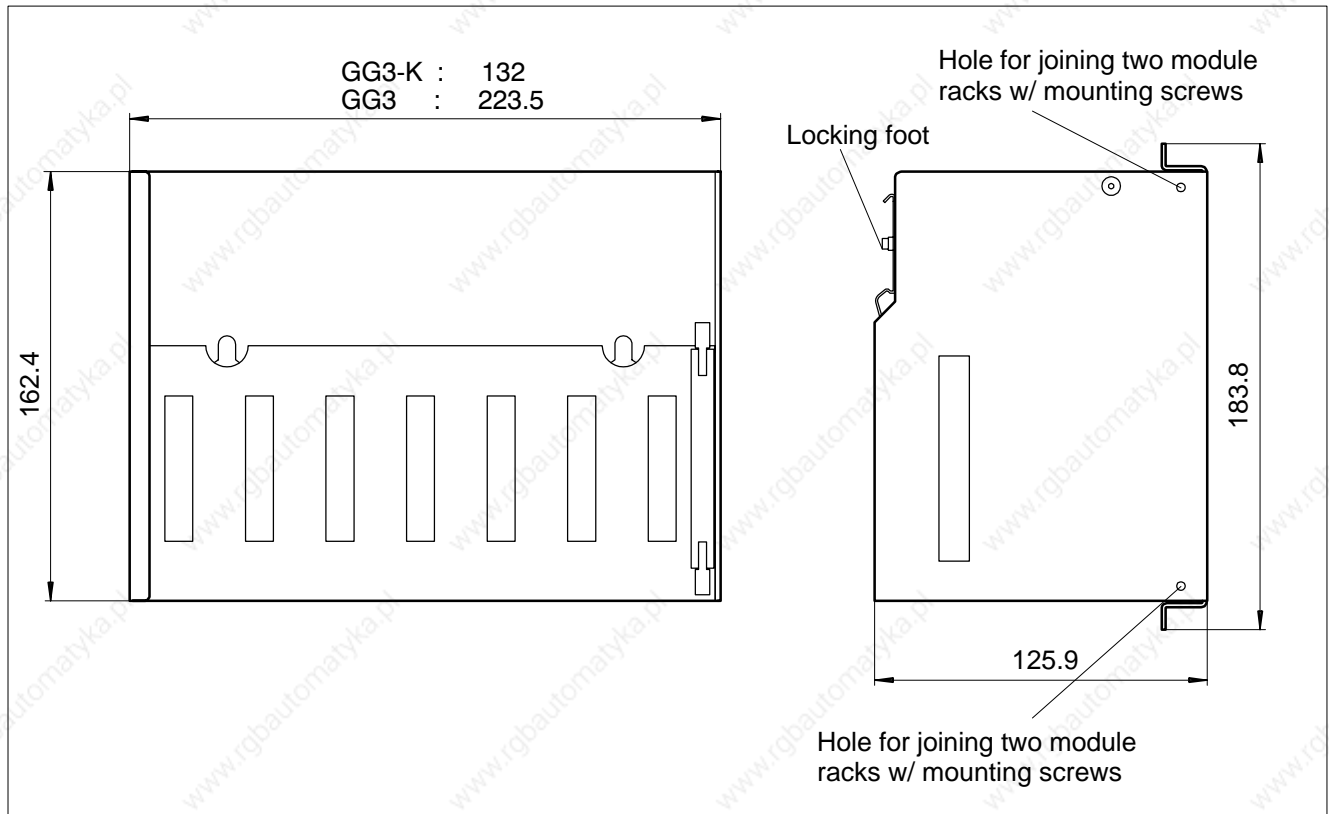

The module racks GG3 and GG3-K are suitable for installation in a control cabinet meeting IP54 protection category requirements.

The GG3 and GG3-K module racks can be installed in two ways:

- horizontal rack installation
- vertical rack installation, in which case the permissible operating temperature as per EN 61131-2 is reduced to between 5 and 40 °C, and only 50% of the outputs may have a HIGH signal applied at the same time.

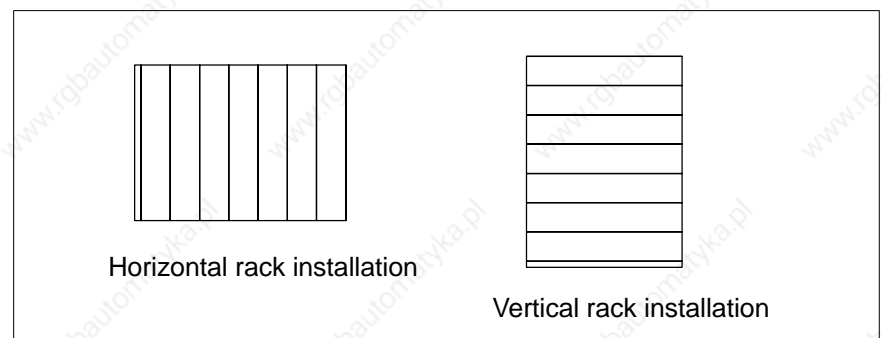

Clear space

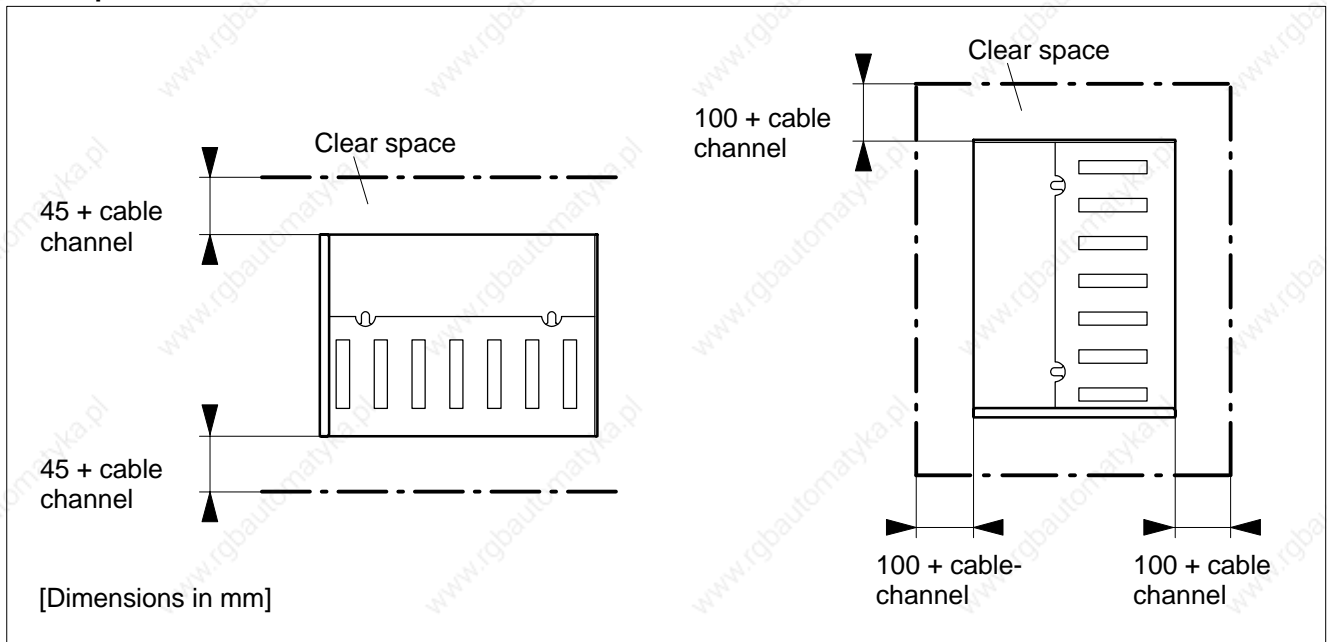

Installation

The GG3 / GG3-K module rack can be secured in one of the following ways:

- Screw mounted surface installation
- Installation via locking foot, and insertion in 35 x 7.5 mm support rail, as per EN 50022.

 **The locking foot is not supplied as standard equipment with the module racks, and must be ordered separately (refer to page 3-1).**

Screw mounted surface installation, drilling template

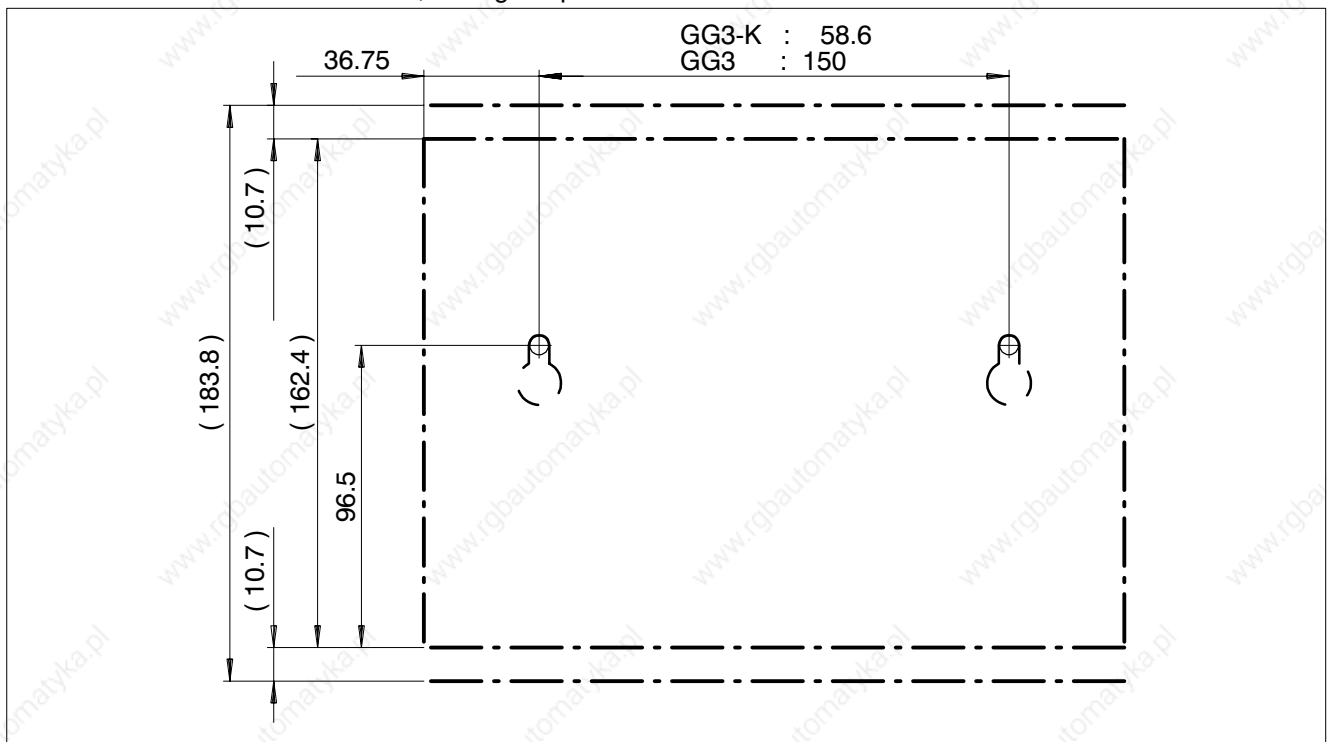

Installation using locking foot

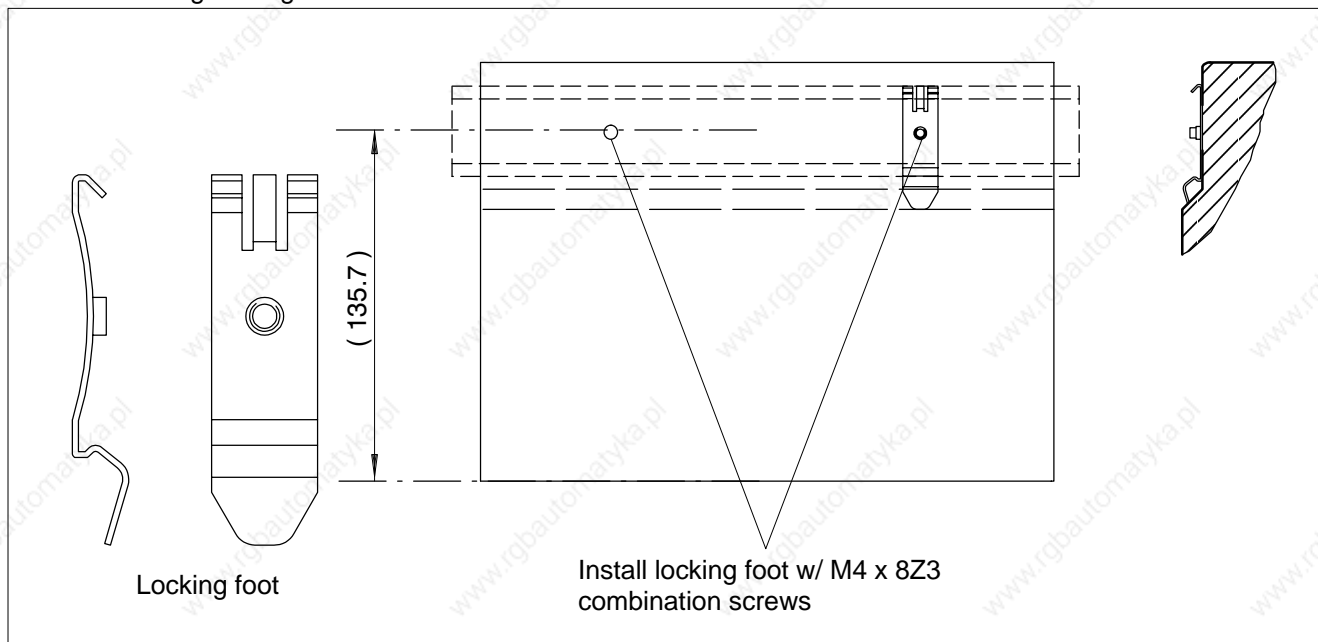

3.3 Basic Unit

In its minimum configuration, the basic unit consists of:

- GG3 or GG3-K module rack
- NT200 power supply module
- Central processing unit

The remaining module slots can be used for

- Digital input / output modules
- Analog modules
- Intelligent modules (R200, R200P, COM2E)
- Max. of 1 AG/S expansion module



 Empty slots must be closed with dummy covers.

Ordering information

Designation	Order no.
GG3 Module rack	1070 075 100
GG3-K Module rack	1070 079 961
Locking foot for support rail	1070 077 225
NT200 Power supply module	1070 075 096
Buffer / backup battery	1070 917 152
ZE200 Central processing unit	1070 075 169
ZE200A Central processing unit	1070 075 171
ZE200M Central processing unit	1070 075 175
ZE200AM Central processing unit	1070 075 176
ZE201 Central processing unit	1070 078 795
ZE200-DP Central processing unit	1070 078 883
ZE200A-DP Central processing unit	1070 081 448
Dummy cover	1070 075 174

3.4 Expansion Unit

 **When planning an expansion, the maximum address range and the current draw of the controller must always be observed.**

The CL200 can be expanded very easily to accommodate additional modules. The GG3 or GG3-K module rack is used as an expansion unit.

There are several structural options for expansion:

- Inline configuration with a maximum of 2 GG3 module racks.
- Dual inline configuration comprising one GG3 plus one GG3-K module rack.
- Multi-row inline configuration comprising a maximum of three rows, including a maximum of two GG3 module racks.
- Multi-row inline configuration comprising three rows with one GG3 and GG3-k module rack each.

The connection between two module racks is accomplished with the use of:

- Bus coupler, connecting two module racks in a row
- AG/S expansion module for interconnecting two inline rows

 **Empty slots must be closed with dummy covers.**

Ordering information

Designation	Order no.
GG3 Module rack	1070 075 100
GG3-K Module rack	1070 079 961
Locking foot for support rail	1070 077 225
Bus coupler	1070 075 110
AG/S Expansion module	1070 075 916
AG/S Connecting cable, 0.3 m	1070 077 162
Dummy cover	1070 075 174

3.4.1 Expansion Structure

Horizontal installation, inline

One inline row of modules consists of max. 2 module GG3 or GG3-K module racks; alternatively, it may comprise one GG3 plus one GG-K module rack. This expansion unit is mounted directly beside the basic unit (see diagram):

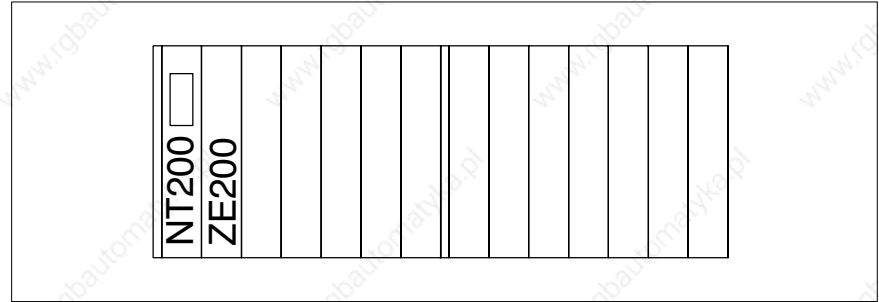

When assembled side-by-side, two GG3 module racks conform to the 19-inch EIA standard.

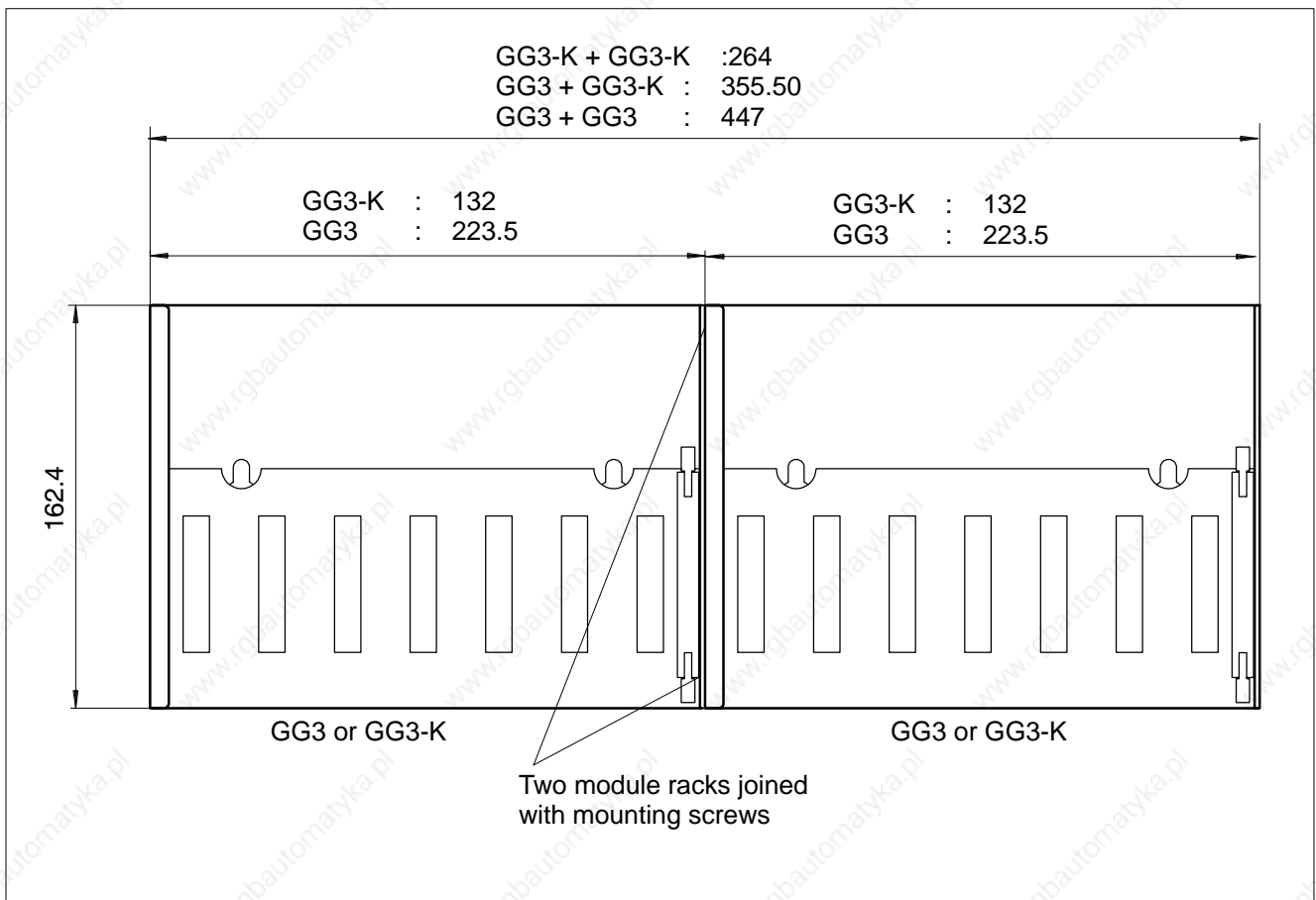

★ Assembling / installing module racks

- Based on drilling template
- or
- On support rail, for multiple-row expansion

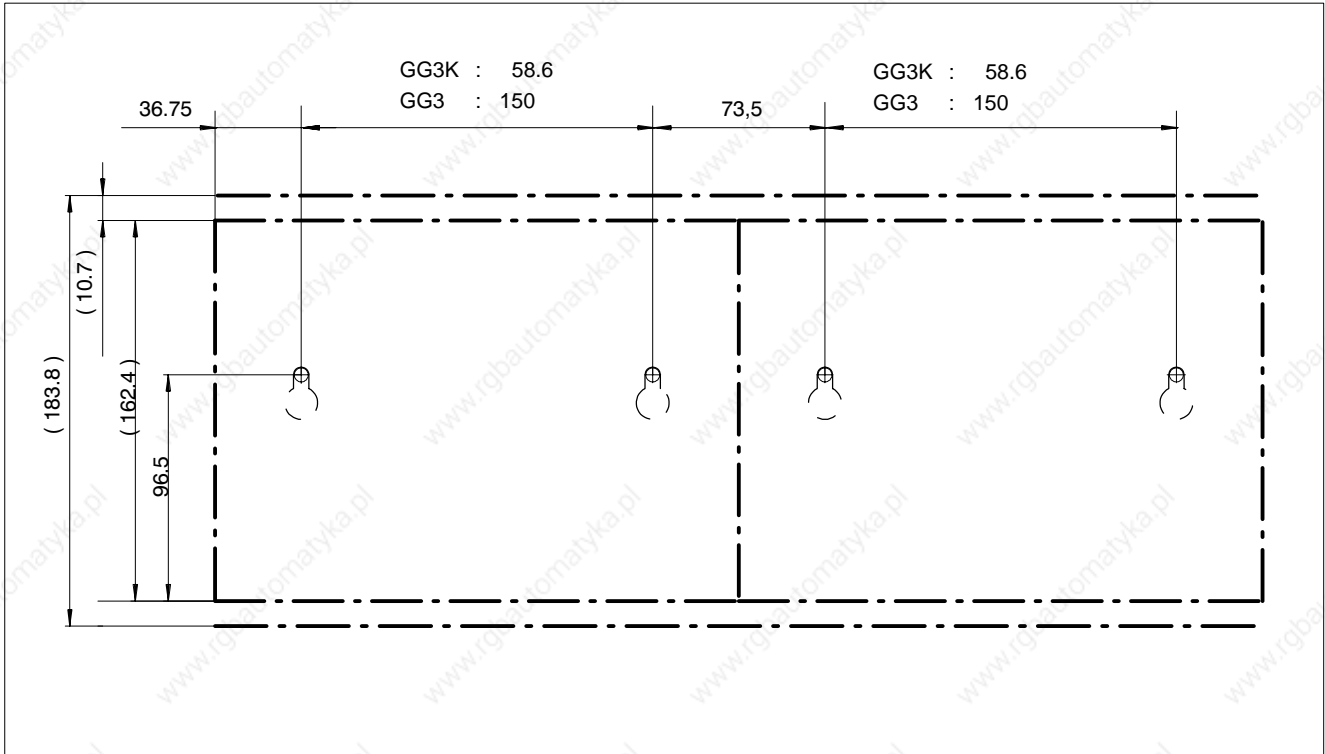

★ Use bus coupler to establish bus connection between module racks.

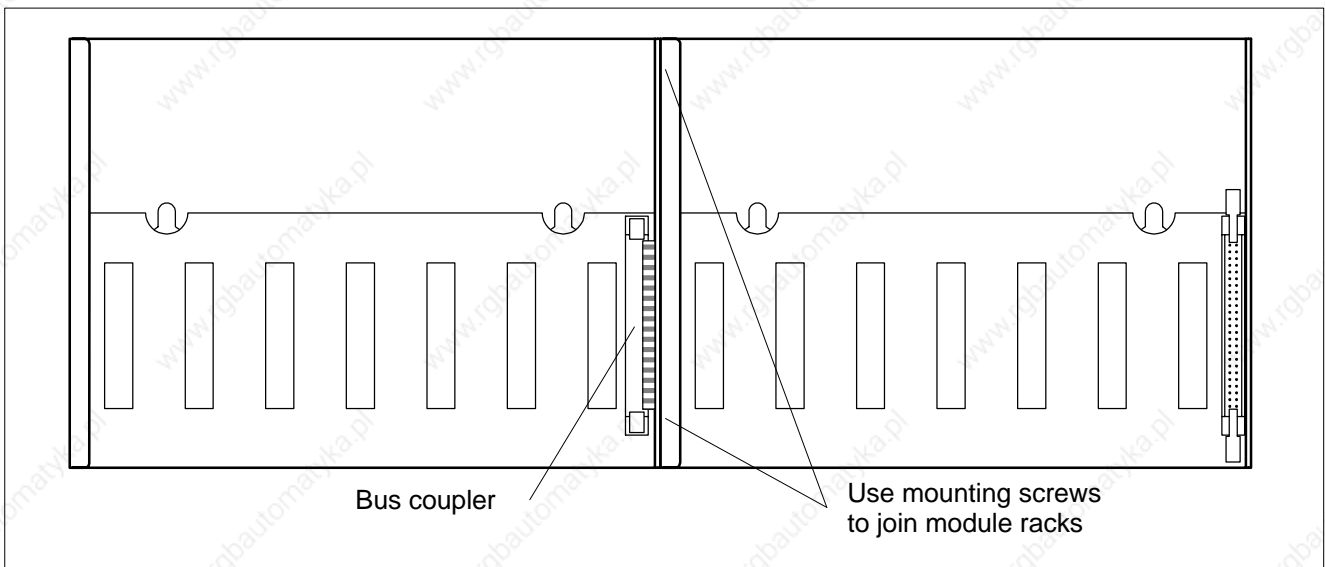

★ Use M3x5 filister head screw and lock washer to join module racks.

Horizontal installation, multi-row inline configuration

In the event that more than two module racks are needed, a multi-row expansion is configured with the use of the AG/S expansion module:

- Maximum possible configuration of 6 module racks
- CPU and power supply module always installed at bottom left
- AG/S must always be inserted in far end right hand module slot.

☞ **The CL200 controller accommodates a maximum of three inline expansion rows.**

When using the AG/S, the maximum permissible distance between to module racks is 5 meters.

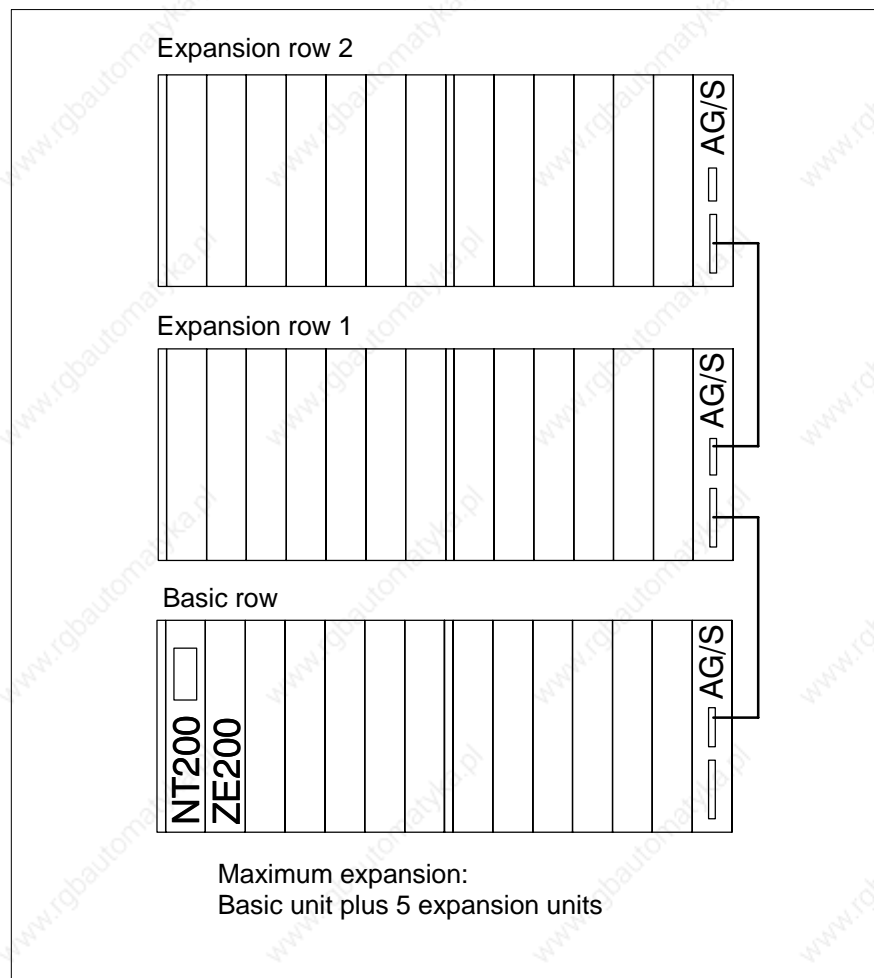

Surface mounted installation

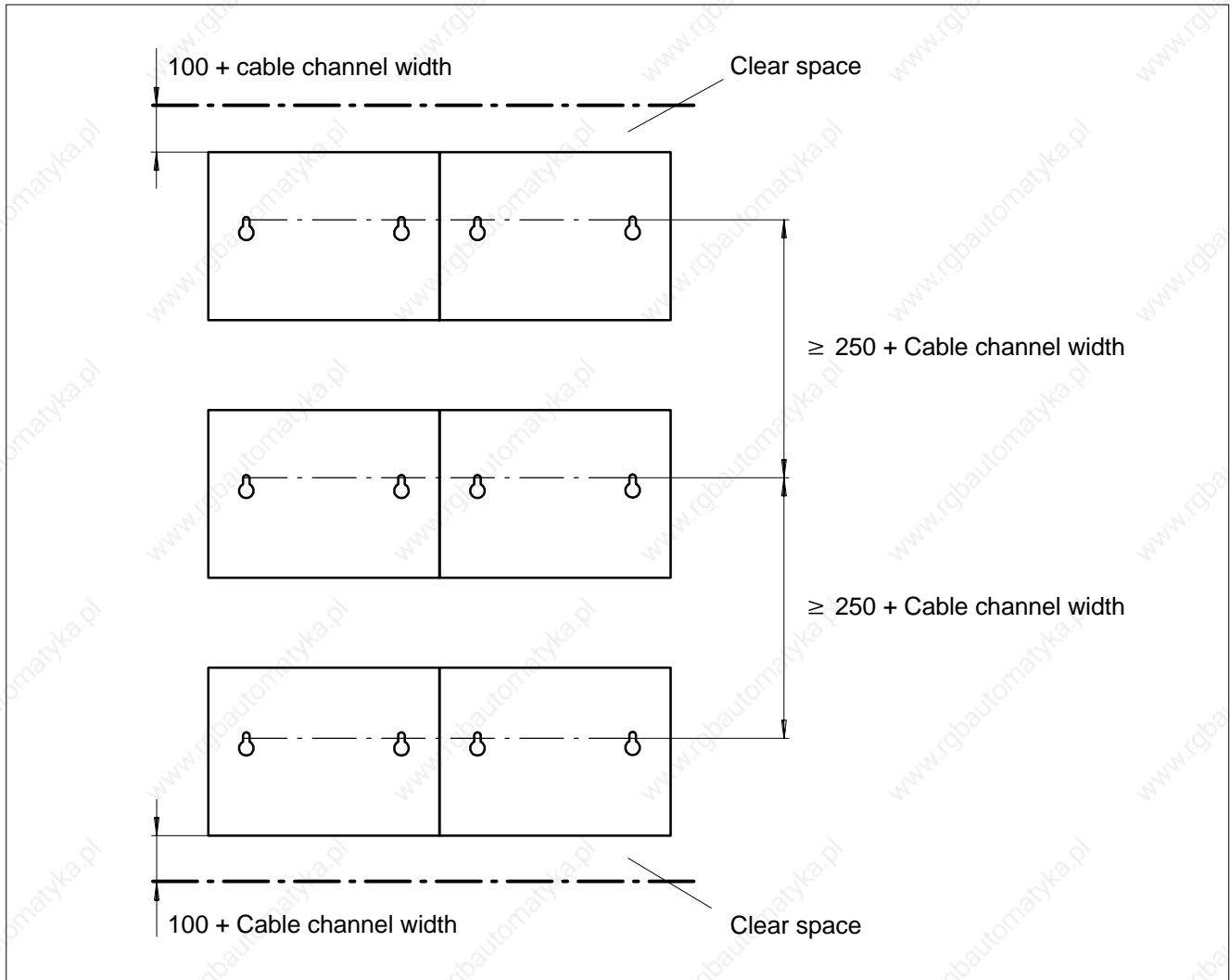

 **The height of the cable channel should not exceed 65 mm.**

Support rail installation

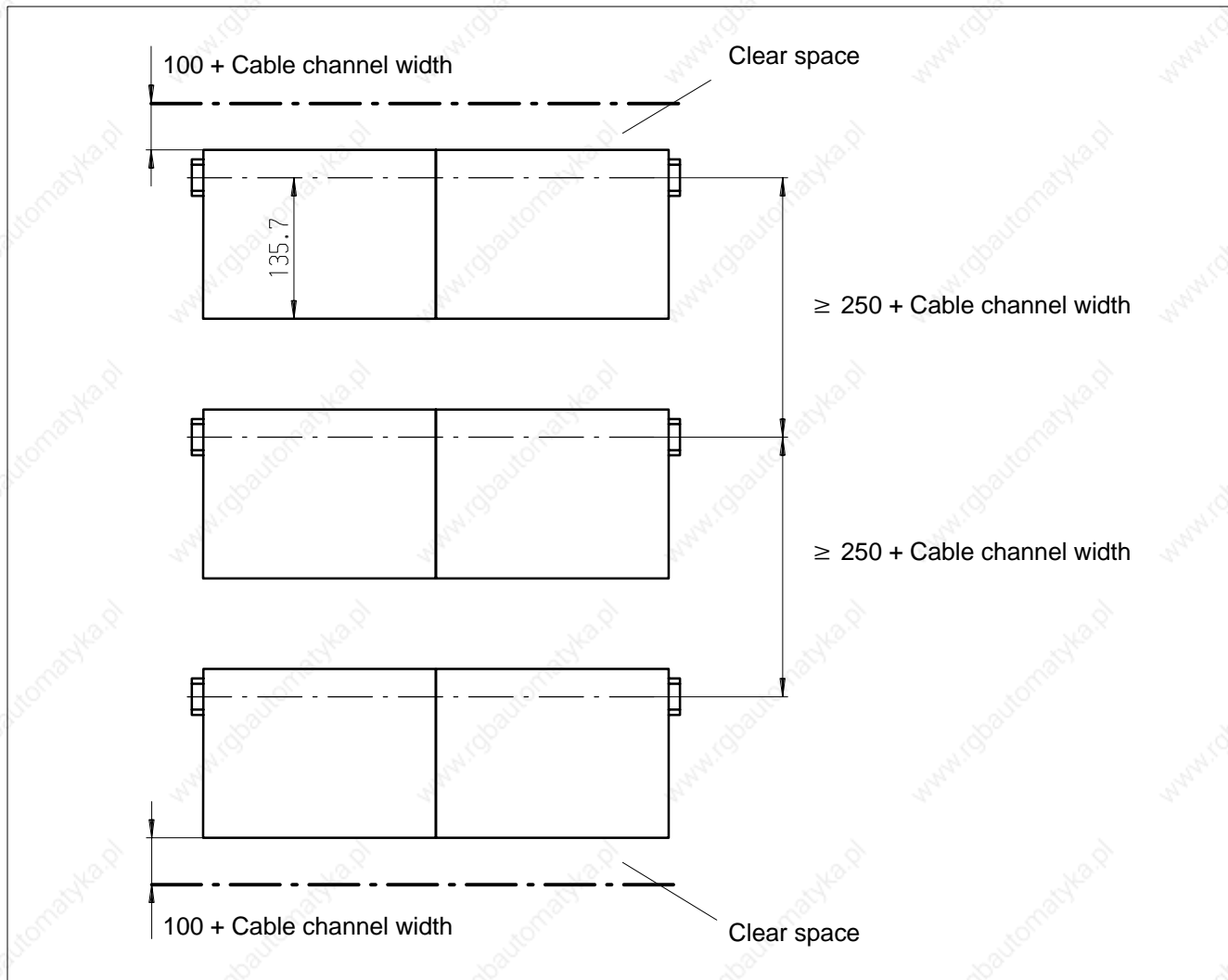



 The height of the cable channel should not exceed 65 mm.

Vertical module rack installation

The vertical arrangement of the CL200 is permissible only in a single-row configuration. The following restrictions must be observed:

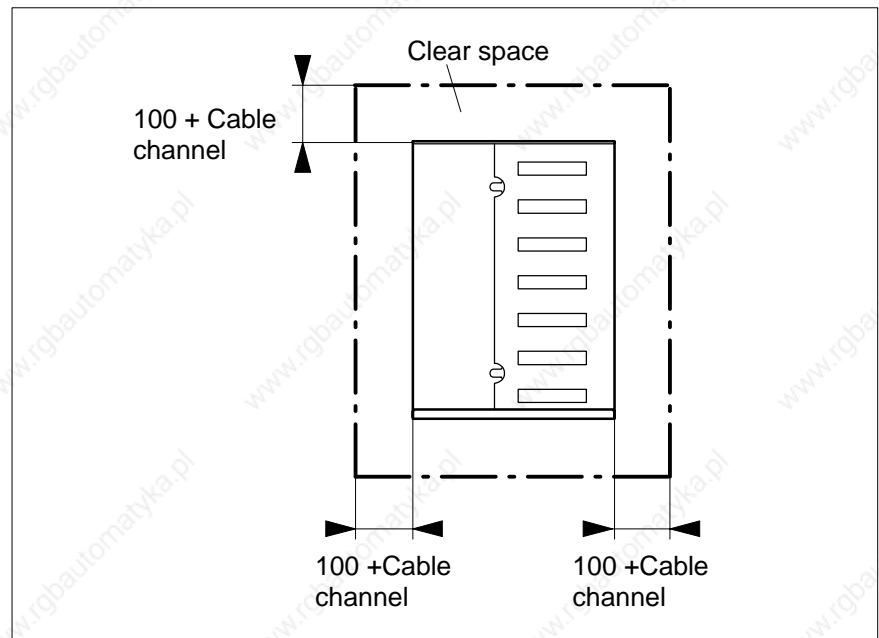
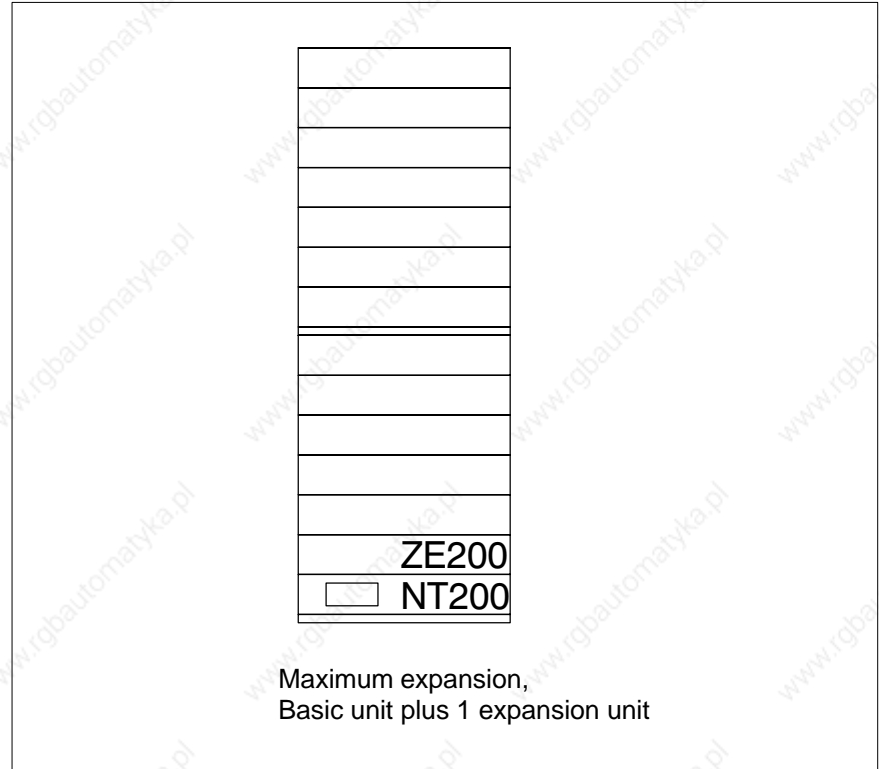
- The maximum permitted configuration is two module racks.
- CPU and power supply module always to occupy bottom slots.



 **When using vertical installation, the permissible operating temperature as per EN 61131-2 is reduced to between 5 and 40 °C, and only 50% of the outputs may have a HIGH signal applied at the same time.**

Notes:

4 NT200 Power Supply Module

4.1 Features and Functions



The NT200 power supply module performs the following functions:

- Provision of internal operating voltages:
 - 5 V for the central processing unit
 - 3.4 V memory backup battery voltage
 - 7.5 V for peripheral modules
 - 12 V ISO for 20 mA interface
- Undervoltage monitoring of 24 V power supply
- Bridging power intermittents in 24 V power supply
- Monitoring internal power supply
- In the event of a failure of the 24 V power supply, the buffered controller memory is powered by a backup battery.
- Monitoring the backup battery

 **The power supply module in the basic unit does not provide 24 V power for peripheral modules, signal encoders and actuators. These require a separate 24 V power supply. Refer to information in section 17.1.**

Module slot

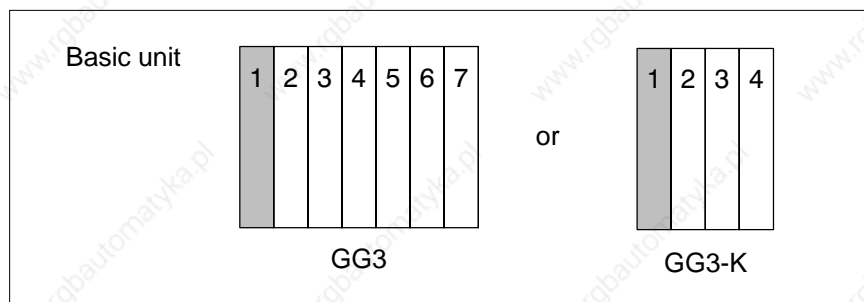
**DANGEROUS ELECTRICAL VOLTAGE****Hazard to personnel!**

Operation of the NT200 power supply module generates voltage peaks which significantly exceed the functional extra low voltage. The module may be powered up only while inserted in the module rack.

**CAUTION**

Do not insert or remove the module while the controller is switched ON! This may destroy the module. Prior to inserting or removing the module, switch OFF or remove the power supply module of the controller, external power supply and signal voltage!

**CAUTION****Risk of module damage!**

Observe all ESD protection measures when handling modules and components! Prevent electrostatic discharges!

 Observe instructions in Chapter 17, Installation.

4.2 Display and Control Elements

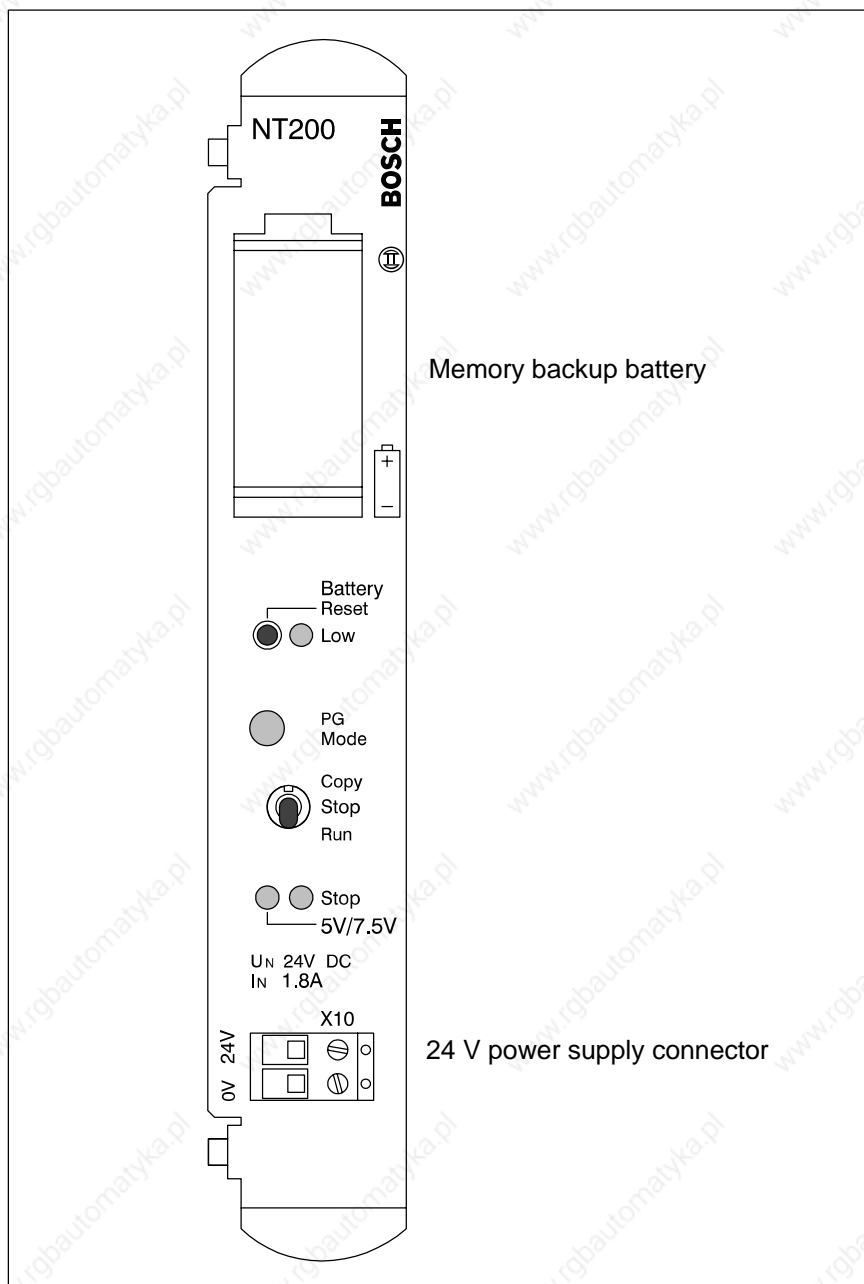

Low Battery LED

The Low Battery LED indicates battery failure.

Battery Reset button

The Battery Reset button performs two functions:

- RESET and acknowledgement of a battery failure.
- Activation of battery load test. If a fault is detected, the Low Battery warning signal S30.7 in the system area goes HIGH.

PG Mode LED

☞ Refer to Chapter 5, Central Processing Unit, section 5.2, Display and Control Elements

Copy / Stop / Run switch/button

☞ Refer to Chapter 5, Central Processing Unit, section 5.2, Display and Control Elements

Stop LED

☞ Refer to Chapter 5, Central Processing Unit, section 5.2, Display and Control Elements

5V / 7.5V LED

When this LED illuminates, the 5 V and 7.5 V supply voltages for central processing unit and periphery modules are present.

X10 connector

The X10 connector comprises the terminal for the 24 V power (form factor 5.08).

4.3 Memory Backup Battery

The memory backup battery assists the central backup of remanent areas for markers, timers, counters, data field and PLC program. The backup battery powers the internal RAM onboard the central processing unit in the event of a failure of the 24 V power supply, and upon switching off the NT200 power supply module.

Module	typ. current draw in μA at	
	25 °C	55 °C
NT200	18	28
Central processing module	6	28

The service life of the memory backup battery depends on:

- Ambient temperature
- Time interval for which the controller is switched off

 **Replace the memory backup battery after 1 1/4 years at the latest.**

The CL200 uses lithium backup batteries. They contain less than 0.5 g of lithium, and are hermetically sealed. They are not considered a hazardous substance when transported in their original package.

Backup batteries:

- Store in a cool, dry place, at max. 35 °C recommended storage temp.
- Do not short-circuit
- Do not recharge
- Do not deep-discharge
- Do not incinerate
- Do not connect with reverse polarity
- Do not damage or open cells

Low Battery warning

The backup battery is tested on the following occasions:

- Subsequent to powering up the 24 V power supply
- When pressing the Battery Reset button on the front panel of the power supply module

A missing battery or the detection of low battery voltage causes the S30.7 Low Battery signal in the system area to go HIGH.

The same occurs when the battery voltage drops below 2.6 V while the controller is switched on.

Battery failure

A battery failure is detected subsequent to Power-On in the following cases:

- The backup battery is missing.
- Central processing unit or NT200 power supply module has been removed prior to Power-On.

Battery failure is indicated by the Low Battery LED, and the S27.2 battery fault bit goes HIGH.

During RAM operation, when a fault has been detected in the backup battery, the central processing unit remains in STOP mode, and the PLC program is deleted.

The battery fault bit can be acknowledged by pressing the Battery Reset button on the front panel of the NT200 power supply module.

Replacing the battery



CAUTION

Backup battery discharge hazard!

Insert backup battery only while module is inserted in module rack. Otherwise backup battery may be discharged when the module is resting on an electrically conductive surface.



CAUTION

Loss of data!

Removing the backup battery with the 24 V power supply switched off will cause the loss of all remanent data and of the PLC program stored in RAM!

Replace backup battery only while 24 V power supply is switched on!

- ★ Push the battery compartment cover downward and remove.

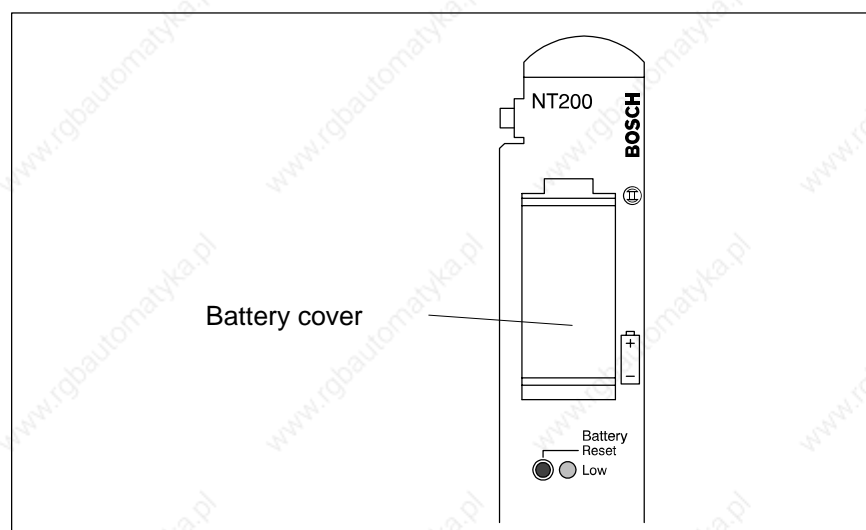

- ★ Remove old backup battery.
This causes a battery warning to be indicated in the system area and on the programming device.
- ★ Gently tap new backup battery on hard surface to break internal oxide layer.
- ★ Ensuring correct polarity, insert new battery.
- ★ Reinstall battery compartment cover, and push upward.
- ★ To cancel the battery warning, press the Battery Reset button on the front panel of the NT200 power supply module.

 **The old backup battery (lithium battery) must be disposed of as hazardous waste (i.e., in Germany under waste code number 35 325). The acceptance provisions of the disposal site must be observed.**

4.4 Specifications

Specifications	NT200
Power supply, as per EN 61131-2	24 VDC, 19.2 through 30 V
Bridging capability, intermittents on power supply module, as per EN 61131-2	Class PS2 ≤ 10 ms, repetition rate ≥ 1 s
Current draw from 24 V power supply <ul style="list-style-type: none"> ● Rated current ● Minimum configuration: NT200, ZE200A, 16 inputs, 16 outputs 	1.8 A typ. 220 mA
Peak inrush current	≤ 40 A
Duration of peak inrush current	≤ 5 ms
Power supply, voltage rated, for <ul style="list-style-type: none"> ● Central processing unit ● Memory backup ● Peripheral modules ● 20mA interface 	5 V 3.4 V 7.5 V 12 V ISO
Power supply, current rated <ul style="list-style-type: none"> ● 5 V for central processing unit and intelligent modules ● 7.5 V for peripheral modules ● 12 V ISO for 20mA interface 	max. 2.7 A 1.5 A max. 150 mA
Memory backup battery <ul style="list-style-type: none"> ● Type ● Capacity ● Battery voltage ● Effective service life 	Lithium battery AA ≥ 850 mAh 3.6 V 1 year (minimum)
Width	1 slot
Weight	400 g

Ordering information

Designation	Order no.
NT200 Power supply module	1070 075 096
Memory backup battery	1070 917 152

5 Central Processing Unit

5.1 Features and Functions

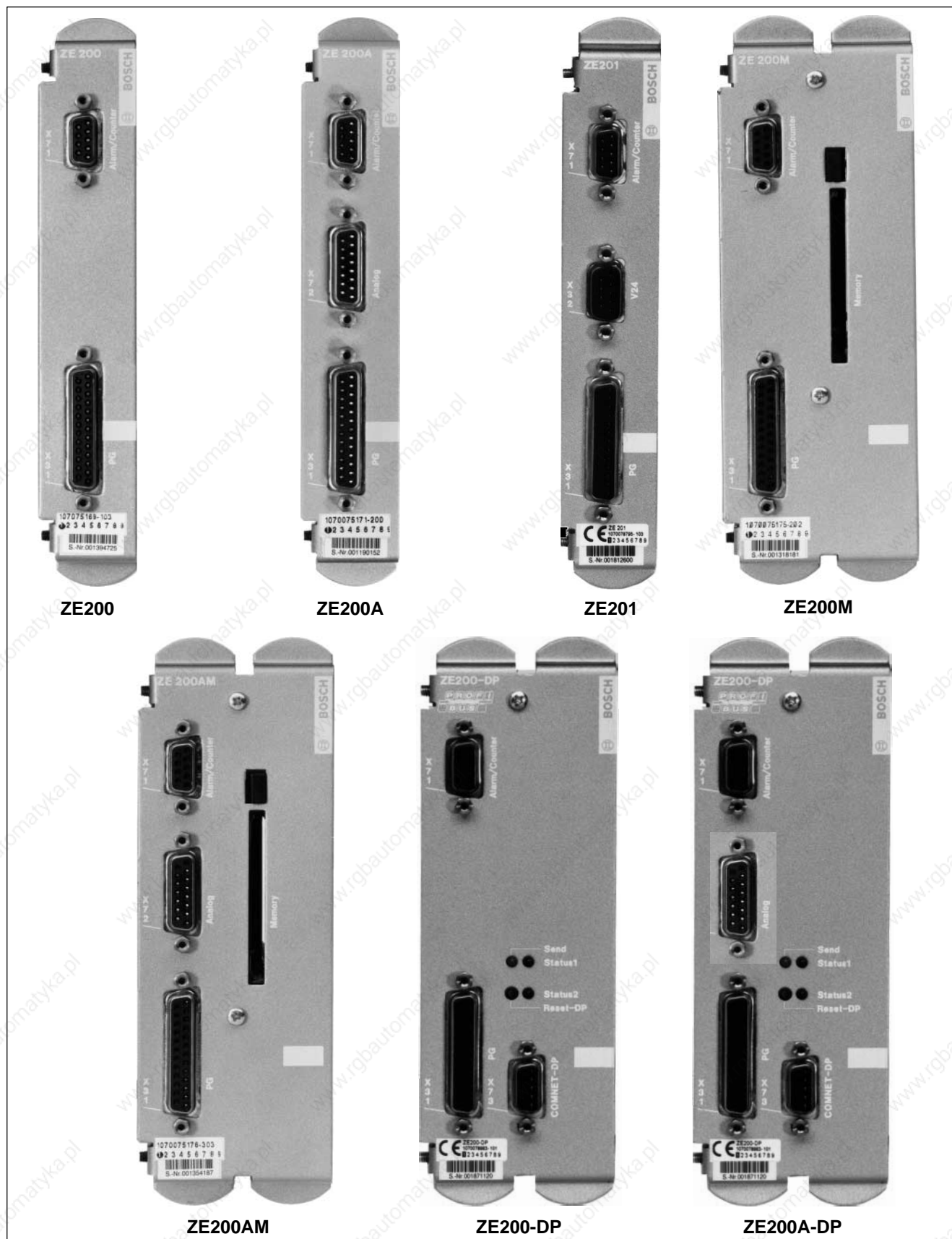

Unit functions

- Decoding and processing instructions and commands contained in the PLC program
- Memory management for data received from peripherals
- Detection and processing of interrupt signals
- System monitoring

PLC program memory

To facilitate PLC program storage, the central processing units feature two internal memory areas.

- 128 kB of internal RAM
- 128 kB Flash-EPROM memory

With a memory **backup battery** installed in the NT200 power supply module, the PLC program can be processed from within the internal 128 kB RAM.

When operating **without backup** battery, the PLC program is processed from within the 128 kB Flash-EPROM memory.

Also possible is **mixed operation** using both RAM and Flash-EPROM memory for data storage.

When operating with RAM or Flash-EPROM, the following memory capacities are available to store the application program:

- 12 kB instructions plus 16 kB data modules, OR
- 18 k instructions without data modules

These values are **doubled** in mixed operation.

The selection of RAM and Flash-EPROM memory and the definition of mixed operation is accomplished with the use of the PLC utility program. Refer also to order no. for "CL200 Operations List", in section 1.6.

Functional features

- Cyclical program processing w/ OM1 organization module
- Setting system parameters in OM2 organization module
- Controlling program processing via organization module OM5 or OM7
- Error management in OM9 organization module
- 2 organization modules for timer controlled functions
- 3 organization modules for interrupt inputs
- Fixation of inputs/outputs and markers

The instruction set used with the CL200 is upward compatible for use with the CL400 and CL500 controllers.

ZE200, ZE200A, ZE200M, ZE200AM, ZE201, ZE200-DP, ZE200A-DP

Seven variants of the central processing unit are available to ensure optimized and cost effective adaptation of the CL200 to a variety of tasks:

- ZE200
System clock, high-speed counters, interrupt inputs
- ZE200A
System clock, high-speed counters, interrupt inputs, 4 analog inputs, 1 analog output

- ZE200M
System clock, high-speed counters, interrupt inputs, MemoryCard
- ZE200AM
System clock, high-speed counters, interrupt inputs, 4 analog inputs, 1 analog output, MemoryCard
- ZE201
System clock, high-speed counters, interrupt inputs, 2nd serial interface
- ZE200-DP
System clock, high-speed counters, interrupt inputs, PROFIBUS-DP interface. Handles the tasks of a bus master, and supports all DP compatible slave devices.
- ZE200A-DP
System clock, high-speed counters, interrupt inputs, 4 analog inputs, 1 analog output, PROFIBUS-DP interface. Handles the tasks of a bus master, and supports all DP compatible slave devices.

System clock

The system clock data is stored centrally in the S128 to S134 system area; it is refreshed cyclically with every I/O image.

- The date values must be entered correctly.
- If the entry of a day of the week is required, the date must be entered correctly, and complete with day-of-week information.

High-speed counters

Two mutually independent 32-bit forward and reverse counters are available. Each counter has two limit values. One of these counters also supports position decoding via incremental rotary encoders.

☞ Refer to section 5.4.2, “X71 Interrupt and High-speed Counter Inputs”.

Interrupt inputs

The central processing units of the CL200 feature three 24 V interrupt inputs.

☞ Refer to section 5.4.2, “X71 Interrupt and High-speed Counter Inputs”.

Analog inputs and outputs

The analog output can supply a current or voltage rated signal.

☞ Refer to section 5.4.3, “X72 Analog Inputs and Outputs”.

MemoryCard

Central processing units ZE200M and ZE200AM feature a MemoryCard slot. The PLCV program can be backed up to or loaded from a MemoryCard.

In addition, all central processing units facilitate program storage also in internal Flash-EEPROM memory.

☞ See also section 5.3, “MemoryCard”.

Second serial interface

The ZE201 provides a second serial interface with additional transmission protocols.

COMNET-DP interface

The ZE200-DP and ZE200A-DP feature a PROFIBUS-DP interface (marked "COMNET-DP" on the module) for field bus connection.

Module slot



CAUTION

Do not insert or remove the module while the controller is switched ON! This may destroy the module. Prior to inserting or removing the module, switch OFF or remove the power supply module of the controller, external power supply and signal voltage!



CAUTION

**Risk of module damage!
Observe all ESD protection measures when handling the module!
Prevent electrostatic discharges!**

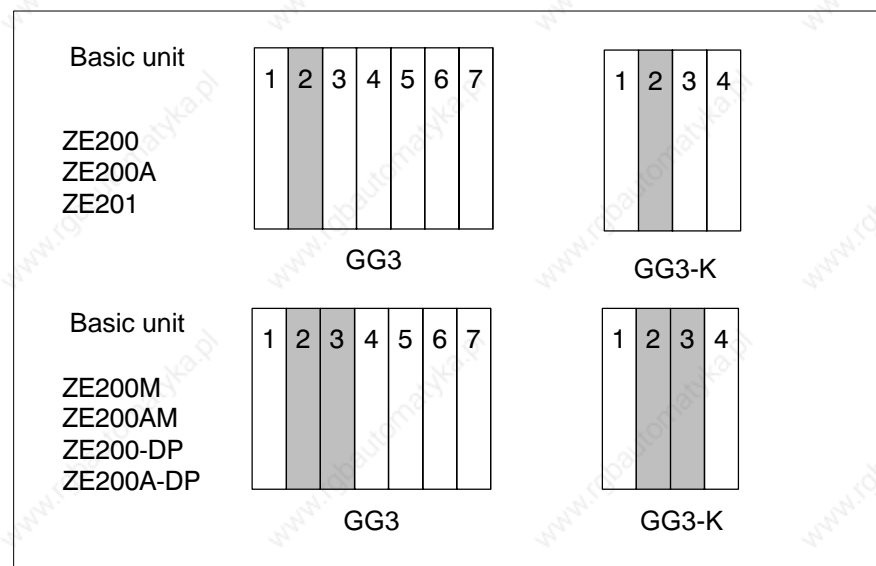

5.2 Display and Control Elements

The display and control elements for the central processing units are located on the NT200 power supply module. The ZE200-DP features two additional status LEDs and one Send LED to monitor the operation of the PROFIBUS-DP interface.

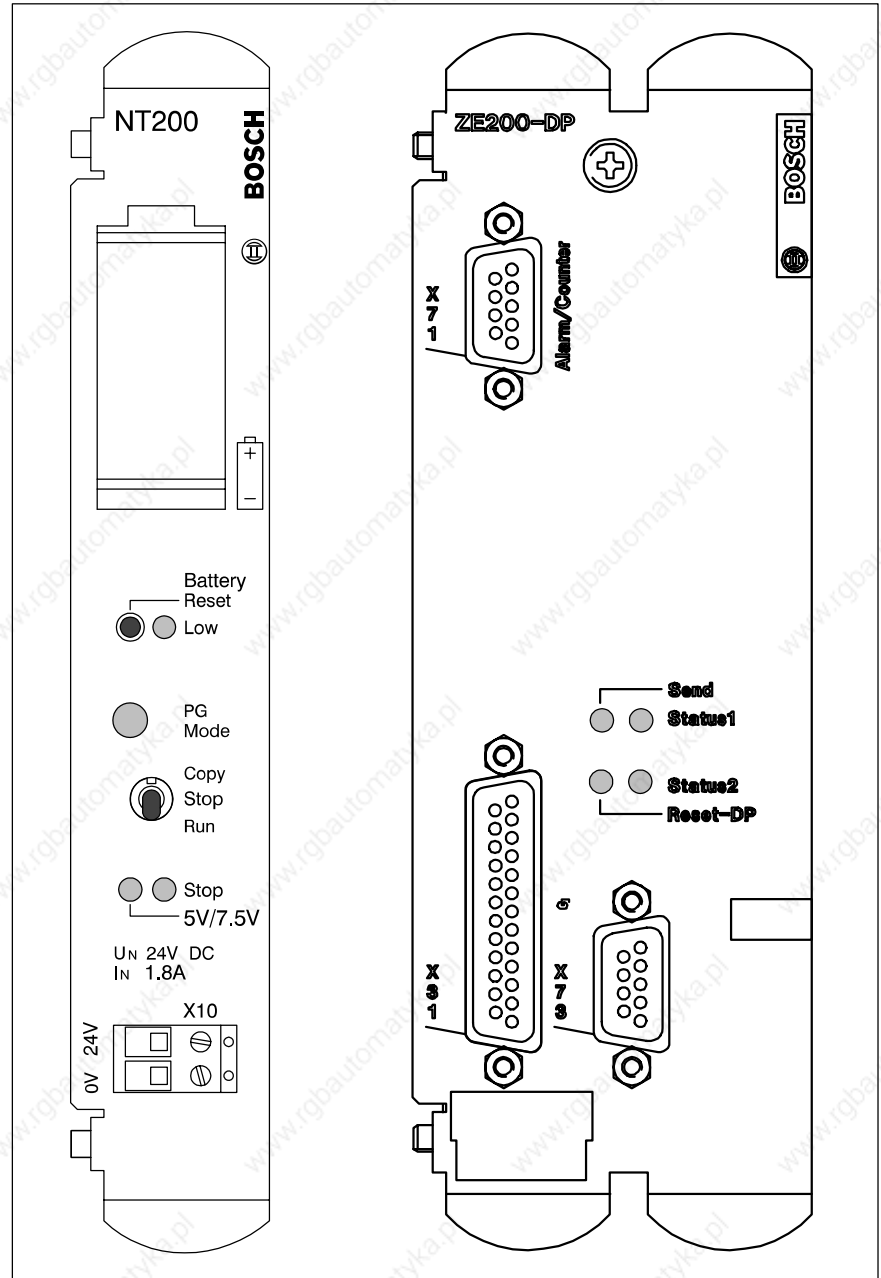

PG Mode LED Stop LED on NT200

The PG Mode and Stop LEDs indicate the following controller operating statuses:

PG Mode	Stop	LED display	Explanation
○		Extinguished	Normal operating status
●		Illuminated	<ul style="list-style-type: none"> ● Outputs disabled ● Inputs / outputs fixed
●●		Flashing	Copying: <ul style="list-style-type: none"> ● RAM → Flash-EPROM ● RAM → MemoryCard
	○	Extinguished	Controller in Run mode
	●	Illuminated	Controller in Stop mode
	●●	Flashing	Copying error: <ul style="list-style-type: none"> ● Flash-EPROM → RAM ● RAM → MemoryCard
●●	●●	Simultaneous flashing, 2 Hz	No firmware found
●●	●●	alternating flashing	Internal error, displayed in PLC utility program
●●●●	●●●●	rapid simultaneous flashing, 8 Hz	Defective central processing unit

Copy / Stop / Run switch/button

The switch provides two positions to select the the operating status of the controller, and one pushbutton position for the Copy function:

- Stop mode
- Run mode
- Copy procedure: – at Power-ON
– during standard operation

☞ Refer also to order no. for “CL200 Operations List”, in section 1.6, chapter “Memory Management”.

Status 1 LED
Status 2 LED
on ZE200-DP
and ZE200A-DP

The Status 1 and Status 2 LEDs indicate the following operating statuses of the PROFIBUS-DP interface, and of the ZE200-DP and ZE200A-DP central processing units.

Status 1	Status 2	LED display	Explanation
○	○	Extinguished	Normal operation
	●	Illuminated	Default master set is loaded. Factory shipped state and/or master parameter set after RESET. DP configuration must be loaded (via WinDP software).
	●●	Flashing	One or more slaves report <ul style="list-style-type: none"> Slave configuration error (SKF) Slave not reachable (SNE) Slave not ready for cyclical data traffic (SNB). (The BM-DP is not operated in Auto CLAB mode [Error_Action_Flag=0])
●	●	Illuminated	When Stop LED on power supply (NT200) also illuminates: <ul style="list-style-type: none"> Startup initialization routine (after Power-ON) is in progress. Central processing unit is in Stop mode. DP bus master is attempting to start using available master parameter set. As long as this status remains active, communication with the PG programming device will be blocked. When Stop LED on power supply (NT200) does not illuminate: <ul style="list-style-type: none"> ZE (central processing unit) hold time expired DP system has not yet been initialized. One or more slaves are not reachable (SNE) or report configuration error (SKF). The ZE was enabled In the event that subsequent DP system initialization is successful, this display will be reset.
●	●●	1 illuminates, 2 flashes	Clear Mode <ul style="list-style-type: none"> DP bus master has recognized a CLAB signal source, and is now being operated in Auto CLAB mode (Error_Action_Flag =1). CLAB sources are: SNE (slave not reachable), SKF (slave configuration error), SNB (slave not ready for cyclical data transfer). Bus master is not enabled by the ZE. Possible cause: ZE is in Stop mode. DP bus master is busy with cyclical I/O data transfer. 00H is transmitted to outputs (outputs deleted).
●●	●●	Simultaneous flashing, 2 Hz	Addresses of centrally equipped I/O modules overlap with decentrally assigned I/O addresses.
●●	●●	Flashing in alternation	Master parameter set is missing or faulty. The DP configuration must be loaded (with the use of WinDP configuration software).
●●●●	●●●●	Rapid simultaneous flashing, 8 Hz	Hardware fault, defective central processing unit

Send LED

The Send LED indicates a data transmission in progress.

Reset DP pushbutton

The Reset DP pushbutton can be used to reset the DP bus master in the cause of an error.

During Power-ON of the supply voltage, pressing the Reset DP pushbutton and holding it until the LED test has ended causes the PROFIBUS-DP configuration to be deleted.

5.3 MemoryCard

The ZE200M and ZE200AM central processing units feature a card slot for the MemoryCard. The MemoryCard is used to load and back up the PLC program.

The ZE200M and ZE200AM are equipped with a PCMCIA ("PC card") interface, version 2.01, and Type 1 card slot for access times in excess of 200 ns.

The ZE200M and ZE200AM central processing units support the following MemoryCards, min. 1 MB capacity:

- Intel Flash Memory card, series 1 compatible
example: SCM FC 001MB-20-200CMB, series 1.



CAUTION

Before touching the MemoryCard, discharge static electricity potential of your body! Remove or install MemoryCard only while unit is deenergized!

The MemoryCard is inserted into the card slot on the central processing unit socket connector first.

 **The MemoryCard does not extend the internal PLC program memory.**

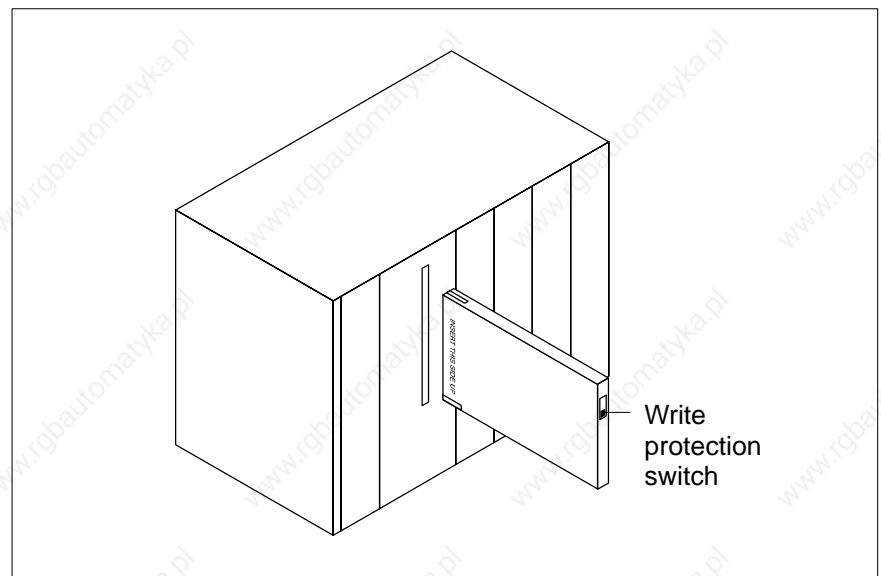

5.4 Interfaces

5.4.1 Interface Connections

All interface interconnections on the CL200 central processing unit are accomplished via D-sub plug connectors. Connections must use screened cables. Almost without exception, interface connectivity entails the interconnecting of cables inbound from a variety of locations. This is accomplished with the use of industry standard adapter elements. Adapter elements must provide a screening connection for D-sub plug connectors.

Example:

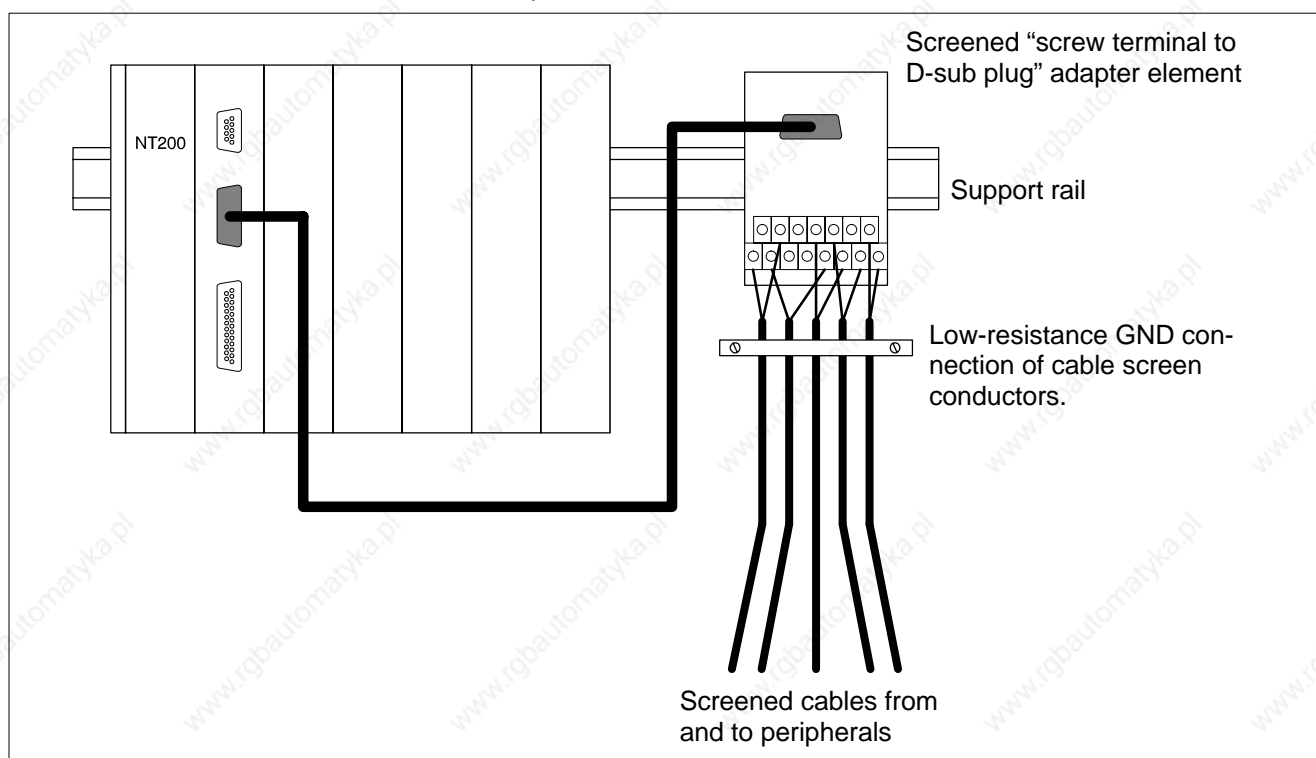

5.4.2 X71 Interrupt and High-speed Counter Inputs

☞ Refer also to “CL200 Operations List”, order no. in section 1.6.

The interrupt inputs and high-speed counters are connected via the female DB-9 connector of the X71 interface.

Pin assignment:

Pin no.	Signal designation	Signal function	Signal direction
1	II0	Interrupt input 0	←
2	GND	Ground	
3	II1	Interrupt input 1	←
4	GND	Ground	
5	II2	Interrupt input 2	←
6	OCI0	Counter input 0	←
7	OCD0	Counter direction 0	←
8	OCI1	Counter input 1	←
9	OCD1	Counter direction 1	←
Housing		Screen	

Interrupt and counter inputs are characterized by very short delay intervals.

Inputs are not electrically isolated. They are protected against polarity reversal to a \pm max. 30 V potential.

Inputs do not feature visual indicators.

Input signal interpretation occurs dynamically.

Inputs can be connected to an output of the A 24 V- / 0.5 A output module without a load.

U/I - Characteristic curve

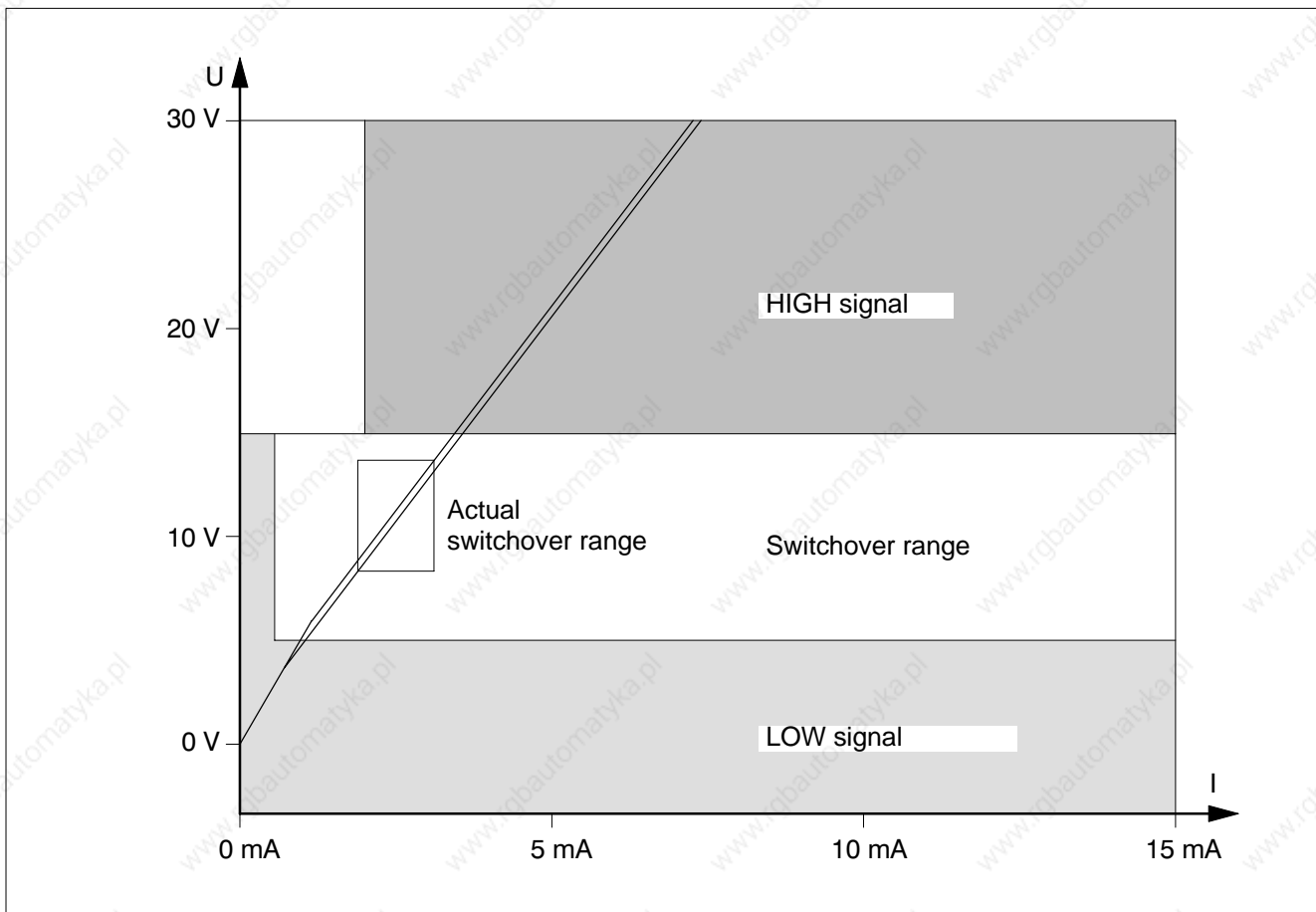

Interrupt inputs

The CL200 central processing units provide three 24 V interrupt inputs.

Specifications	Interrupt inputs
Inputs, as per EN 61131-2	3 digital inputs, Type 1
Rated voltage	24 VDC
Input voltage <ul style="list-style-type: none"> • LOW signal • HIGH signal 	-3 to +5 V 13.2 to 30 V
Input current <ul style="list-style-type: none"> • LOW signal • HIGH signal 	≤ 1 mA 2.5 to 7.5 mA
Input delay <ul style="list-style-type: none"> • LOW → HIGH • HIGH → LOW 	typ. 60 μs typ. 40 μs
Trigger slope	Positive slope
Pulse duration	≥ 100 μs
Cable length	max. 100 m, screened

Interrupt inputs are processed by means of organization modules OM10 through OM12.

High-speed counters

Two mutually independent 32-bit forward and reverse counters are available. Each counter has two limit values.

Counter inputs are not electrically isolated.

Specifications	High-speed counters
Quantity	2, 32-bit counters
Rated voltage	24 VDC
Input voltage <ul style="list-style-type: none"> • LOW signal • HIGH signal 	-3 to +5 V 13.2 to 30 V
Input current <ul style="list-style-type: none"> • LOW signal • HIGH signal 	≤ 1 mA 2.5 to 7.5 mA
Counting frequency	max. 10 kHz
Input delay <ul style="list-style-type: none"> • LOW → HIGH • HIGH → LOW 	Typically 60 μs Typically 40 μs
Pulse duration	≥ 100 μs
Cable length	max. 100 m, screened

High-speed counters are programmed in the OM2 organization module. OM2 also defines which slopes are to be interpreted.

Upon reaching a limit value, a given output assigned in the OM2 automatically goes HIGH.

System area	High-speed counters
S58/S59	Counter Control
Counter 0	
S34/S35	Actual value, LOW word
S36/S37	Actual value, HIGH word
S38/S39	Setpoint value 1, LOW word
S40/S41	Setpoint value 1, HIGH word
S42/S43	Setpoint value 2, LOW word
S44/S45	Setpoint value 2, HIGH word
Counter 1	
S46/S47	Actual value, LOW word
S48/S49	Actual value, HIGH word
S50/S51	Setpoint value 1, LOW word
S52/S53	Setpoint value 1, HIGH word
S54/S55	Setpoint value 2, LOW word
S56/S57	Setpoint value 2, HIGH word

High-speed counters (ROD application)

The following peripheral conditions apply to operation with incremental rotary transducers:

- The function is available for counter 1 only.
- The new mode is enabled by setting the MSB in word 20 of the OM2 organization module to HIGH. This leaves all remaining bits without significance.
- The maximum counter frequency is 10 kHz or 10,000 lines per second.
- Counter 0 is restricted to limited simultaneous use, that is, without external change of direction.
- System utilization at 10 kHz in Encoder mode is approx. 20 per cent.
- Encoder mode does not provide for setpoint value overrun.
- The new mode provides the PLC with a doubled-value interpretation, that is, at 1000 lines per revolution, 2000 pulses are counted.
- Exceeding the permissible 10 kHz frequency will result in faulty counting returns.

The delay of interrupt input 0 is modifiable. As a result, this high-speed input can now also be used to recognize the LOW pulse of incremental rotary transducers (ROD) having a pulse width of 100 μ s. In such case the following specifications apply:

Specifications	High-speed counters as ROD
Counting frequency	max. 10 kHz (excessive frequency results in faulty counting results)
Input delay <ul style="list-style-type: none"> • LOW \rightarrow HIGH • HIGH \rightarrow LOW 	Typically 20 μ s Typically 20 μ s
Pulse duration	\geq 20 μ s

5.4.3 X72 Analog Inputs and Outputs

☞ Refer also to “CL200 Operations List”, order no. in section 1.6.

The ZE200A, ZE200AM, and ZE200A-DP central processing units are the only ones providing 4 analog inputs plus one analog output. They are connected via the X72 female DB-15 connector.

Pin	Signal designation	Signal function	Signal direction
1	AI0	Analog input 0	←
2	AI1	Analog input 1	←
3	AI2	Analog input 2	←
4	AI3	Analog input 3	←
7, 8, 9, 11, 12, 15	GND	Ground	
5	CFG	Analog output, Oper. mode selection	<ul style="list-style-type: none"> ● Power output, current rated: Open ● Power output, voltage rated: Bridged w/ 14 (AOI)
10	AOU	Analog output, voltage rated	→
14	AOI	Analog output, current rated	→
6, 13	NC	Spare	
Housing		Screen	

Analog inputs

The input circuits of the 4 analog inputs are not electrically isolated. Analog inputs do have overvoltage and reverse polarity protection, however. An additional external power supply is not required.

Example of connection diagram:

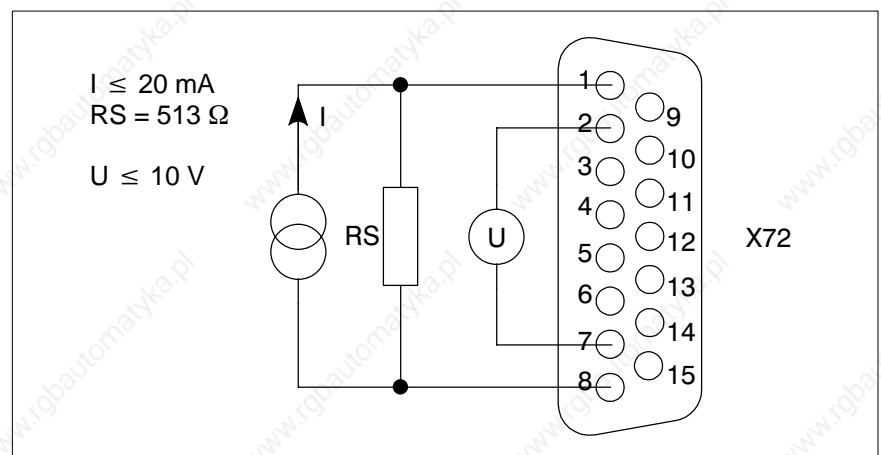

Overload conditions cause the MIN or MAX digital value to be output.

Specifications	Analog inputs
Analog inputs, as per EN 61131-2	4 power inputs
Input voltage range	<ul style="list-style-type: none"> ● 0 to 10 V, unipolar ● Selectable between 2 and 10 V
Input resistance	20 k Ω
Protective circuit	RC circuit, Schottky diodes
Max. permissible continuous overload	Reverse polarity up to supply voltage
Isolation potential	No isolation
Input filter characteristic	1st order
Conversion time	Cycle time plus 10 ms
Sampling interval	20 μ s
Scanning repeat time	10 ms
Operating mode	Time controlled in 10 ms intervals
Conversion mode	Gradual approximation
Digital display	16 bit, straight binary
Resolution	10 bit
Value of LSB	w/o standardization: 10 V : $2^{10} = 9.8$ mV w/ standardization 8 V : $2^{10} = 7.8$ mV
Temperature coefficient	1%, 5 to 55°C
Max. short-term deviation during pulse shaped interferences	≤ 2 %
Cable length	max. 100 m, screened

The data related to the analog inputs are stored in the system area, S64 through S71. With standardization enabled, the analog inputs are monitored for cable breaks. Cable breaks are reported in system area S80.

System area	Analog inputs
S64 / S65	Channel 0
S66 / S67	Channel 1
S68 / S69	Channel 2
S70 / S71	Channel 3
S80	Cable break messages

Analog output

The analog output is a short-circuit protected current or voltage rated power output. The analog output is not electrically isolated.

An additional external power supply is not required.

Example of connection diagram:

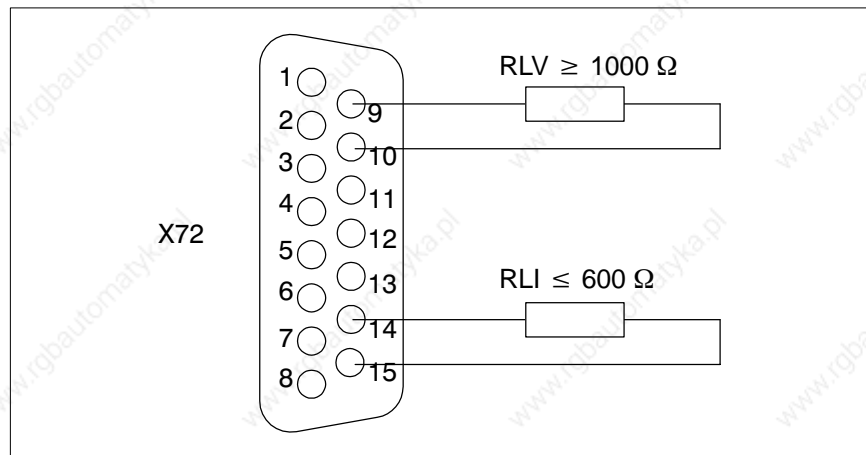

When switching the controller power supply ON or OFF, the analog output provides an output value of 0 (zero).

Specifications	Analog output
Analog output, as per EN 61131-2	1
Power output, voltage rated <ul style="list-style-type: none"> • Voltage range • Load resistance • Short-circuit current 	<ul style="list-style-type: none"> • 0 to 10 V • Standardizable to between 2 and 10 V via OM2 ≥ 1 kΩ 32 mA
Power output, current rated <ul style="list-style-type: none"> • Current range • Load resistance 	<ul style="list-style-type: none"> • 0 to 20 mA • Standardizable to between 4 and 20 mA via OM2 ≤ 600 Ω
Output impedance within signal range <ul style="list-style-type: none"> • Current rated • Voltage rated 	11.6 kΩ 24.9 kΩ
Isolation potential	No isolation
Settling time, full amplitude	< 2 ms
Overshoot	No overshoot
Conversion time	Cycle time plus 16 μs
Digital display	16 bit, straight binary
Resolution	12 bit
Value of LSB (w/o standardization)	<ul style="list-style-type: none"> • 10 V : $2^{12} = 2.4$ mV • 20 mA : $2^{12} = 4.9$ μA
Value of LSB (w/ standardization)	<ul style="list-style-type: none"> • 8 V : $2^{12} = 2.0$ mV • 16 mA : $2^{12} = 3.9$ μA
Temperature coefficient	1 %, 5 to 55 °C
Monotonicity	Yes
Non-linearity	< ± 1 LSB
Repeat accuracy	> 99 %
Output ripple	< 100 mV _{SS}
Short-term deviation during pulse shaped interference	≤ 2 % (Deviations are below 2 % in a normal industrial environment. In extreme interference conditions sporadic deviations in excess of 2 % may occur.)
Cable length	max. 100 m, screened

The output of analog values always occurs with the next exchange of the I/O image.

System area	Analog output
S82 / S83	Channel 0

5.4.4 X31 Interface for PG Programming Unit

The X31 is a combination V.24 / 20 mA interface in accordance with VDI Guideline VDI 2880, Page 2.

The X31 female DB-25 connector accepts the PG programming unit or another peripheral device, such as the BT20 control panel, for example.

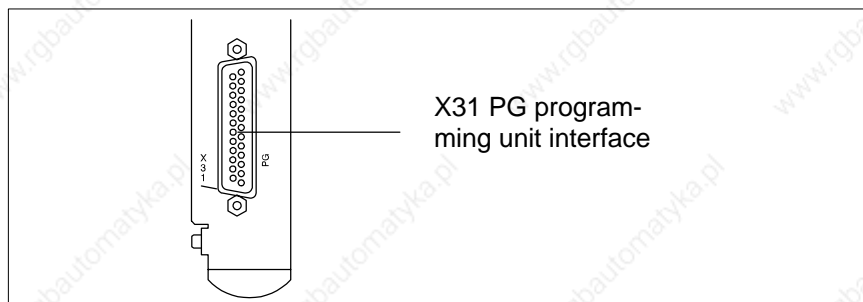

The transmission protocol used on this interface is the BUEP19E (PST).

Baud rate

The baud rate for the X31 programming unit interface is selected with the use of the S1 DIP switch onboard the central processing unit.

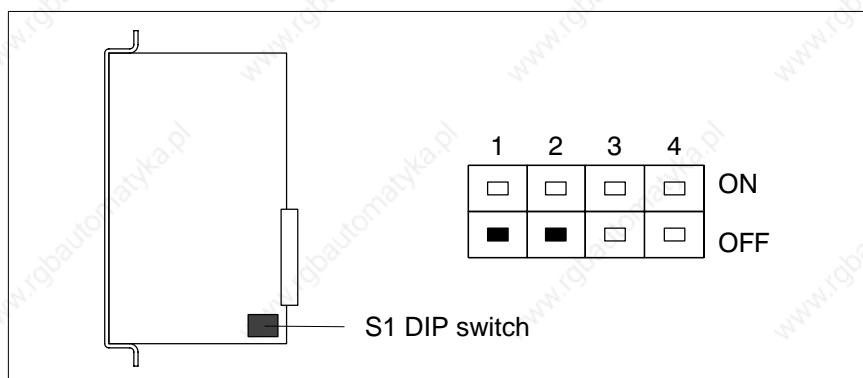

CAUTION

Do not insert or remove the module while the controller is switched ON! This may destroy the module. Prior to inserting or removing the module, ensure that module is not energized!

Baud rate [Baud]	S1/1	S1/2
57600	ON	ON
38400	OFF	ON
19200	ON	OFF
9600	OFF	OFF

Switch segments S1/3 and S1/4 are not being used at this time, and shall therefore be set to OFF.

Transmission protocol

The following transmission protocol is permanently set:

- Even parity
- 1 Stop bit
- 8 Data bits

There are no control lines.

V.24 interface

As the V.24 interface is not electrically isolated from logic circuits and power supply, this may on rare occasions connectivity problems with devices whose interface also lacks electrical isolation.

If this is the case, sufficient potential equalization must be established between the reference conductors of both interfaces. Only a small potential differential may exist between transmitter and receiver, for example:

$$-2 \text{ V} < U_{\text{diff}} < +2 \text{ V.}$$

Signal level: logic 1 -5 V
 logic 0 +5 V

Pin assignment, female DB-25 connector:

Pin	Signal designation	Signal function
Housing	Screen	Screening
2	TxD	PLC transmit data
3	RxD	PLC receive data
7	GND	Reference conductor, Ground

20 mA interface

Line status: logic 1 : 20 mA
 logic 0 : no current

Pin assignment, female DB-25 connector (**passive**):

Pin	Signal designation	Signal function
Housing	Screen	Screening
21	12 V GND	12 V reference conductor
22	RXD+	Receive data +
12	RXD-	Receive data -
23	TXD+	Transmit data +
13	TXD-	Transmit data -

Pin assignment, female DB-25 connector (**active**):

Pin	Signal designation	Signal function
Housing	Screen	Screening
10	12 V out	12 V out
9	12 V in	12 V in
21	12 V GND	12 V reference conductor
12	RXD+	Receive data +
24	RXD-	Receive data -
13	TXD+	Transmit data +
25	TXD-	Transmit data -

Connecting cable

 **Do not route data lines parallel to power lines.**

A premanufactured connecting cable is available to connect to the X31 interface connector:

Designation	Order no.
K16 Connecting cable, 5 m	1070 054 956

The maximum permissible length, even of premanufactured cables, depends on the type of cable used. The cable shall be a screened, twisted-conductor 14 x 0.14 mm² cable. The following values may not be exceeded:

- Line resistance 0,135 Ω/m
- Line capacitance 120 pF/m

Interface	Baud rate [Baud]	max. Cable length [m]
V.24	up to 57600	15
20 mA	9600	300
	19200	150
	38400	100
	57600	50

5.4.5 X32 Second Serial Interface

This V.24 interface on the ZE201 utilizes a female DB-9 connector and is compatible with the COM port on a PC. For example, in the event that a control terminal is connected to X31, this second serial interface can be used to connect the programming unit.

As the V.24 interface is not electrically isolated from logic circuits and power supply, this may on rare occasions connectivity problems with devices whose interface also lacks electrical isolation.

If this is the case, sufficient potential equalization must be established between the reference conductors of both interfaces. Only a small potential differential may exist between transmitter and receiver, for example:

$$-2 \text{ V} < U_{\text{diff}} < +2 \text{ V.}$$

Pin assignment of female DB-9 connector:

Pin	Signal designation	Signal function
2	RxD	PLC receive data
3	TxD	PLC transmit data
5	GND	Reference conductor, Ground
Housing	Screen	Screening

The maximum cable length is 15 m for all baud rates.

Transmission protocols

The X32 interface supports the following transmission protocols:

- BUEP19E (PST, as for X31)
The BUEP19E protocol of the second interface provides functional compatibility with the X31 PG interface. The AST function is not available.
- BUEP03E
As is the case with the intelligent modules, the BUEP03E is handled via the R2REQ and R2CON function modules. To send requests via the X32, all that is required is to address the fictitious RSS number "FFH".

Basic setting

The following basic setting generally applies to the second serial interface immediately after Power-ON:

- 19200 baud
- 1 Stop bit
- Even parity
- 8 Data bits
- BUEP19E protocol

In the event that a change of transmission protocol and transmission speed is required, the desired declaration is made in the OM2. The new constellation is set with data word 36. Configuration baud rates are 600, 1200, 2400, 4800, 9600, and 19200 baud.

The second serial interface always uses one stop bit and active parity. Control signals are not supported.

Limitation

With the operation of the second serial interface, a response time on the interrupt inputs that is shorter than 1 ms can no longer be guaranteed.

Connecting cable

 **Do not route data lines parallel to power lines.**

A premanufactured connecting cable is available to connect to the X32 interface connector:

Designation	Order no.
ZS/PG Connecting cable	1070 077 753

Cable length

The maximum permissible length, even of premanufactured cables, depends on the type of cable used. The cable shall be a screened, twisted-conductor 14 x 0.14 mm² cable. The following values may not be exceeded:

- Line resistance 0.138 Ω/m
- Line capacitance 120 pF/m
- Cable length 15 m

5.4.6 X73 PROFIBUS-DP Interface

The PROFIBUS-DP interface on the ZE200-DP and ZE200A-DP comprises an electrically isolated RS-485 interface and conforms to the EN 50170-2 standard. All components are designed for a baud rate of 12 Mbaud.

The X73 connector is a female DB-9. In addition to the bus signals, the interface supplies an isolated 5 V power potential (VP) for feeding an external device. The maximum permissible load on that device is 100 mA.

Pin assignment of female DB-9 connector:

Pin	Signal designation	Signal function
Shell	Screen	Screening
3	RxD/TxD-P	Receive / Transmit data P
4		Repeater control signal P (TTL-Signal)
5	DGND	Data reference signal
6	VP	Feed power; 100 mA
8	RxD/TxD-N	Receive / Transmit data N
9		Repeater control signal N (DGND)

 **The screen must be attached to the connector shell via a low-impedance connection at both cable ends.**

Decentralized I/O address range

Inputs	I0 ... 23	Max. 24 bytes
Outputs	O0 ... 15	Max. 16 bytes
Extended inputs	EI0 ... 127	Max. 128 bytes
Extended outputs	EO0 ... 127	Max. 128 bytes
Channels	32 channels	w/ 58 bytes I and 58 bytes O ea.

Additional characteristic data

Max. number of slaves	64 DP slaves addressable
Max. outputs per slave	244 bytes
Max. inputs per slave	122 bytes
Max. consistency block size	122 bytes

Direct access

Instances of direct access to decentralized I/O are mapped to an internal image, and will reach the decentralized periphery only during I/O status.

PLC cycle time

With regard to PLC cycle time on the ZE200-DP and ZE200A-DP, the following shall be observed:

- For each 256 bytes of decentrally assigned I/O, the I/O state shifts by approx. 1 ms.
- In the case of diagnostic data processing or transmission problems on the DP bus, a max. 30 % extension of the cycle time may be expected.

Baud rates

The transmission speed is set with the use of the WinDP configuration software for the PROFIBUS and then stored in the master parameter set.

Configuration

The configuration of the DP section requires the use of the WinSPS / WinDP software for Microsoft Windows.

Standard function modules

The following function modules are provided for the operation of the DP section:

DP2STAT	Operation of DP section with diagnostic transfer. (If diagnostic functions are not required, decentralized operation can be carried out without this function module.)
FIFODM1	Required to handle FIFO modules in decentralized application.
SPSKANAL	Required for communication of all module types via the channels.

Connecting cable

When operating a PROFIBUS field bus installation, both stations representing the bus termination must be powered up (active bus termination).

The following components are available for wiring the PROFIBUS:

Designation	Order no.
Tow cable, cable type A	1070 917 201
Solid cable, cable type A	1070 917 202
Bus connector, male, w/ inductances	1070 918 538
Bus connector, female, w/ inductances and male PG connecting plug	1070 918 539
Repeater, 12 Mbaud	1070 918 723

The maximum permissible cable length depends on the cable type used, the transmission rate and installed repeaters:

Baud rate [Baud]	Length in m
up to 93.75	12000
187.5	1000
500	400
1500	200
3000	100
6000	100
12000	100

- The above length information presupposes the use of cable type A (as per EN50170-2) with appropriate bus terminating resistors.
- Up to a speed of 1.5 Mbaud, a spur line length of 6.6 m is permissible (total of all spur lines in a given segment).
- For speed between 3 Mbaud and 12 Mbaud, a spur line length of 1.6 m is permissible (total of all spur lines in a given segment). Direct-axis inductances as per EN50170-2 are required in all cabling.

5.5 Operating modes

The central processing units of the CL200 feature 2 internal memory sections for the PLC program.

- RAM
- Flash-EEPROM memory

Besides the purely RAM or Flash-EEPROM operation of the CL200, mixed operation is also possible (doubled memory capacity).

All settings affecting the operating mode are made via the PLC utility program on the PG programming unit.

 **For detailed information, refer to manual “CL200 Operations List”; order no. in section 1.6.**

5.6 Reloading the Firmware

The firmware onboard the central processing units can be reloaded. The re-loading / updating procedures are described in the README file supplied with the software.

5.7 Specifications

Specifications	ZE200	ZE201	ZE200A	ZE200M	ZE200AM	ZE200-DP	ZE200A-DP
Program memory	128 kbytes RAM and 128 kbytes Flash-EPROM						
System clock	Yes						
Analog inputs / outputs	No	No	4/1	No	4/1	No	4/1
High-speed counters	2 x 32 bit counters or 1 x connection for incremental rotary transducer (ROD; not ZE200-DP and ZE200A-DP)						
Interrupt inputs	3						
MemoryCard slots	No			Yes		No	
Serial interfaces	1		2		1		1
PROFIBUS-DP bus master	No					Yes	
DP slaves						max. 64	
DP baud rate						9.6 kbaud to 12 Mbaud	
Command processing time							
● Bit command	0.3 μ s						
● Word command	0.3 to 10 μ s						
● Complex commands	up to 40 μ s						
I/O image	0.3 to 1.0 ms						
Cycle time for 1 k commands	< 0.5 ms						
Interrupt response time	< 1.0 ms (on ZE201, ZE200-DP, ZE200A-DP longer on rare occasions)						
Registers	4						
OM organization modules	19, OB1 through OB19						
PB program modules	256, PB0 through PB255						
Nesting depth	32 modules						
Bracket levels	7						
Operand formats	Bit, byte, word, double word for constants						
I Inputs							
● I: Bit, byte, word	192 bits, I0.0 through I23.7						
● EI: Byte, word	128 bytes, EI0 through EI127						
● Analog	-	-	4	-	4	-	4
O Outputs							
● O: Bit, byte, word	128 bits, O0.0 through O15.7						
● EO: Byte, word	128 Byte, EO0 through EO127						
● Analog	-	-	1	-	1	-	1
M Markers	1536 bits, M0.0 through M191.7						
T Timers	128, T0 through T127						
C Counters	64, C0 through C63						
DM Data modules	256, DM0 through DM255						
DF Data fields	8 kbytes, DF0 through DF8191						
S System area	256 bytes, S0 through S255						

Specifications	ZE200	ZE201	ZE200A	ZE200M	ZE200AM	ZE200-DP	ZE200A-DP	
Current draw from <ul style="list-style-type: none"> • 5 V for central processing unit • Memory backup battery • 7.5 V for peripheral modules • 12 V ISO for 20 mA interface 	Typically 200 mA		Typically 250 mA			Typ. 650 mA	Typ. 675 mA	
Interfaces <ul style="list-style-type: none"> • Memory • X31 			PCMCIA, version 2.0, Type 1 slot			V.24 / 20 mA interface, PG programming unit interface		
<ul style="list-style-type: none"> • X32 • X71 • X72 • X73 		Second serial interface	Interrupt inputs and high-speed counters					
			Analog I/O as per EN 61131-2		Analog I/O as per EN 61131-2		Analog I/O as per EN 61131-2	
			-				PROFIBUS-DP	
Weight	200 g	200 g	200 g	375 g	375 g	400 g	400 g	
Width	1 Slot			2 Slots				

Ordering information

Designation	Order no.
ZE200 Central processing unit	1070 075 169
ZE200A Central processing unit	1070 075 171
ZE200M Central processing unit	1070 075 175
ZE200AM Central processing unit	1070 075 176
ZE201 Central processing unit	1070 078 795
ZE200-DP Central processing unit	1070 078 883
ZE200A-DP Central processing unit	1070 081 448
MemoryCard	1070 917 668

6 E 24 V– Digital Input Modules

6.1 Features and Functions

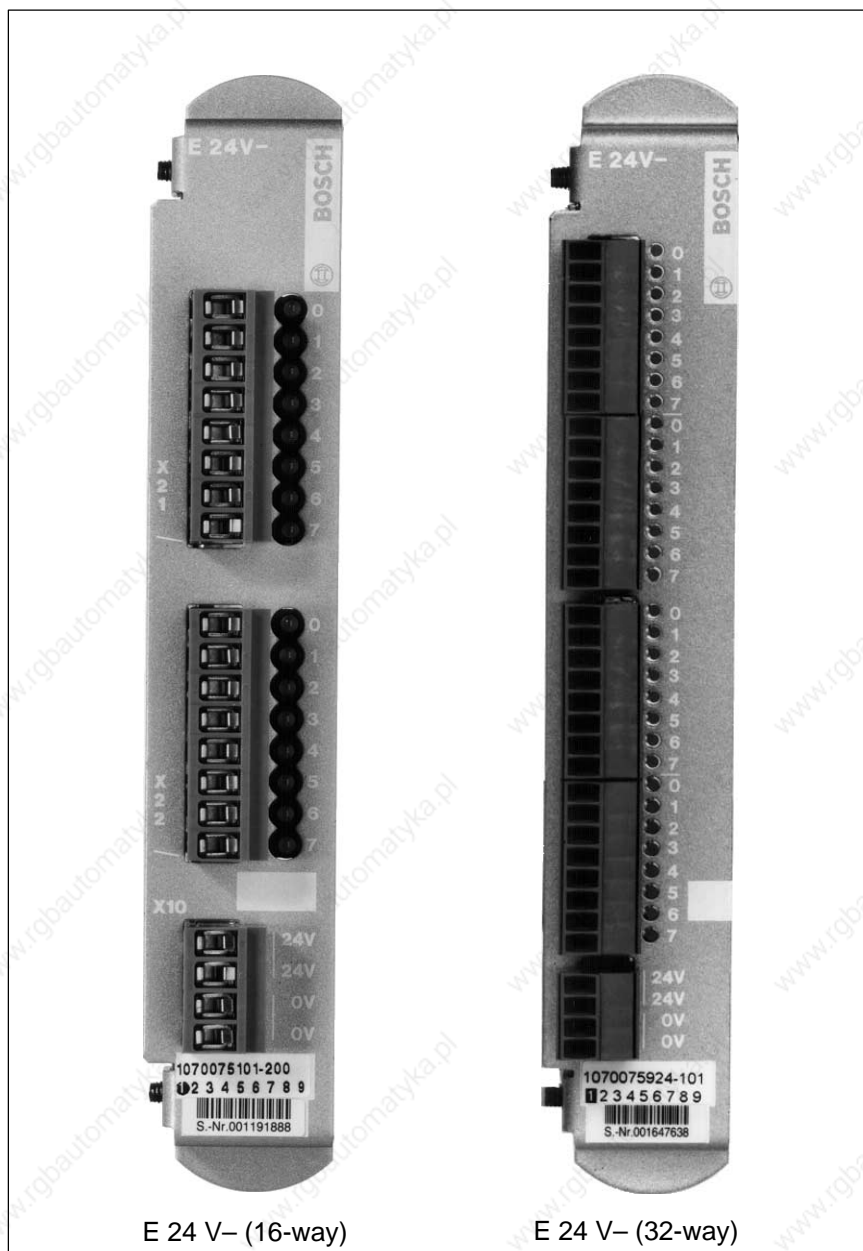

The E 24 V– digital input modules for the CL200 provide 16 or 32 digital inputs in accordance with Type 1 of the EN 61131-2 standard.

The process signals are electrically isolated from internal logic circuits by means of optocouplers. Each input is coupled with a separate LED which indicates signal status:

- LED illuminates: 1
- LED extinguished: 0

Modul slots

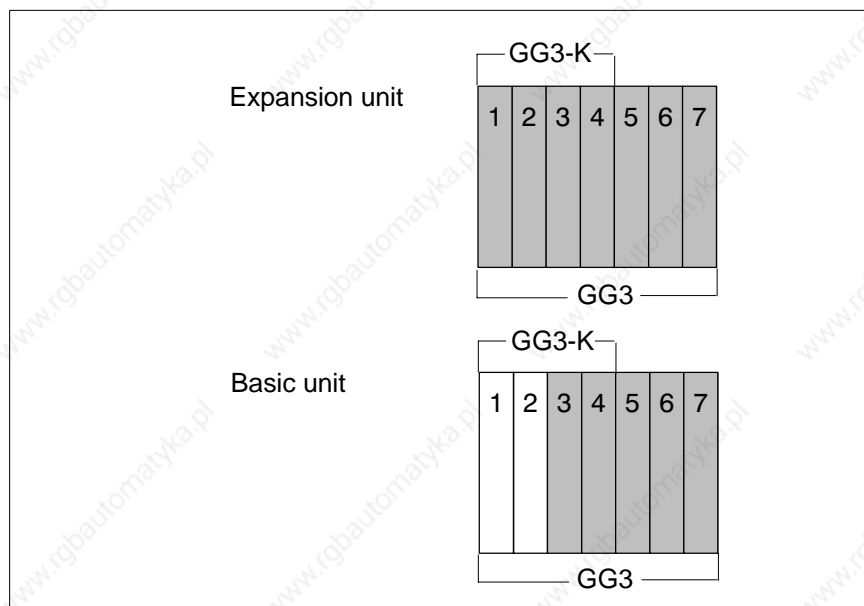
**CAUTION**

Do not insert or remove the module while the controller is switched ON! This may destroy the module. Prior to inserting or removing the module, ensure that module is not energized!

**CAUTION**

Do not insert or remove the module while there is power applied (to digital inputs)! This may destroy the module. Prior to inserting or removing the module, ensure that module is not energized!

**CAUTION**

Risk of module damage!
Observe all ESD protection measures when handling the module!
Prevent electrostatic discharges!

6.2 Connection

All of the 16 or 32 inputs have common 24 V and 0 V potential.
An input can be connected to an output of the output modules without additional load.

Connection via push-lock terminals:

- max. cable cross section : 1.5 mm²
- max. terminal current 6 A

Any two-wire proximity switch meeting the following requirements can be connected:

- Closed-circuit current ≤ 1.7 mA
- Voltage drop ≤ 6 V
- Holding current see V/I characteristic curve

Not suitable for connection are:

- 2-wire proximity switches that largely exploit the IEC 947-5-2 standard
- 2-wire proximity switches according to the NAMUR standard

Input circuit diagram

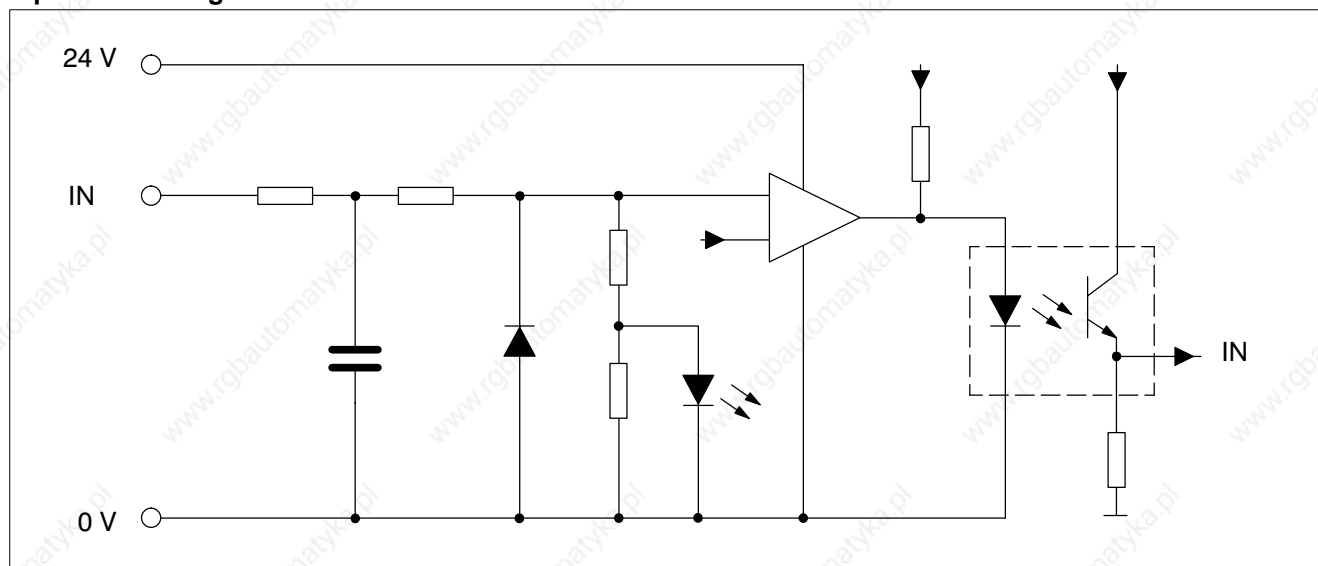

V / I characteristic curve, as per EN 61131-2

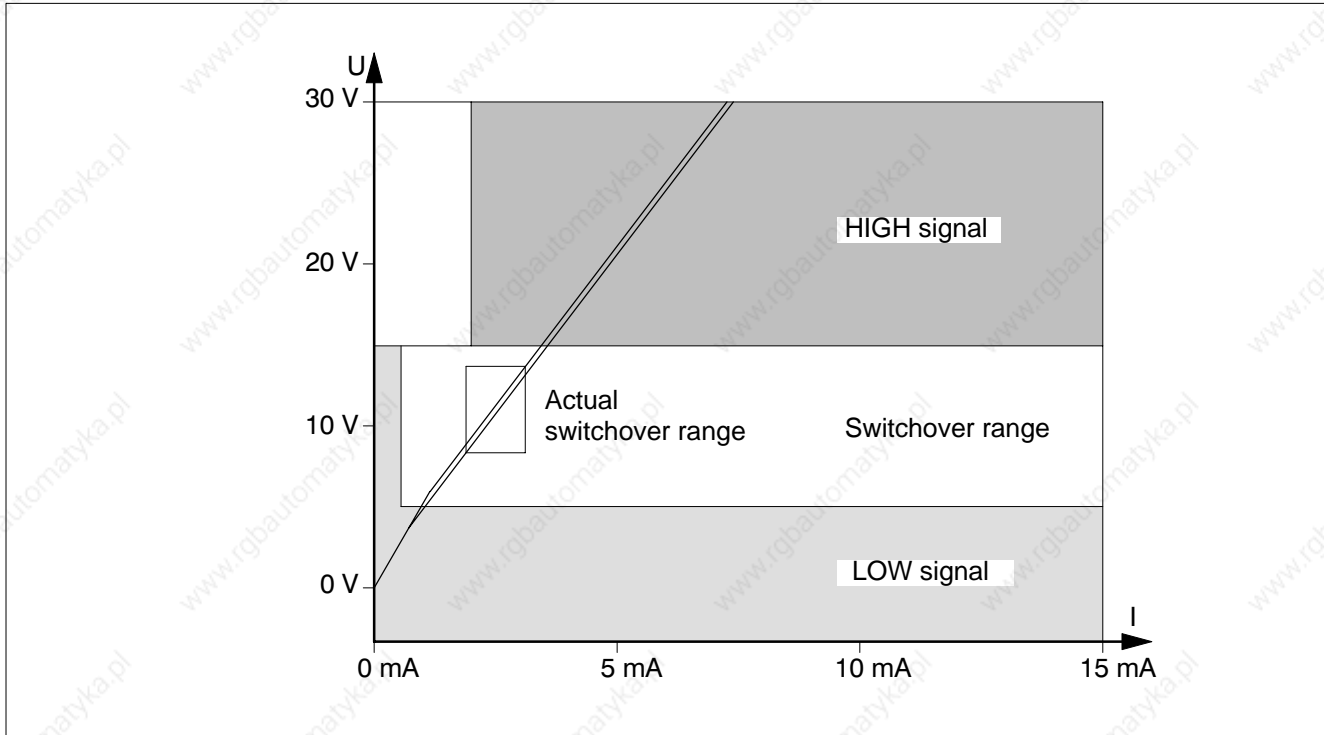

Addressing

A start address must be set for each module on the S1 DIP switch (example below is for an E 24 V-, 32-way):

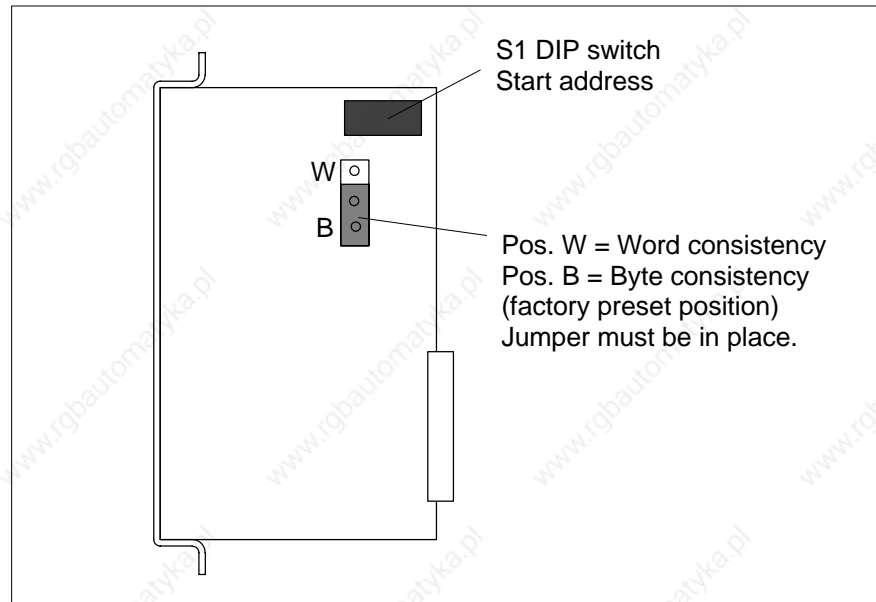

The DIP switch elements S1 through 8 are used to select between input I and extended input field EI.

Switch	8	7	6	5	4	3	2	1
Weighting		2 ⁶	2 ⁵	2 ⁴	2 ³	2 ²	2 ¹	2 ⁰
Value	I = OFF EI=ON	64	32	16	8	4	2	1

6.3 Specifications

Specifications	E 24 V– (16-way)	E 24 V– (32-way)
Inputs, as per EN 61131-2	16 digital inputs, Type 1	32 digital inputs, Type 1
Internal current draw from <ul style="list-style-type: none"> • NT200 (7.5 V) • RM2-DP12 (7.5 V) 	25 mA	45 mA
Isolated potential	Yes, optocoupler	
Isolation test	500 VDC	
Reverse polarity protection of supply voltage	Yes, electronic	
Rated voltage	24 VDC	
Input voltage <ul style="list-style-type: none"> • LOW signal • HIGH signal 	0 through +5 V 13.2 through 30 V	
Input current <ul style="list-style-type: none"> • LOW signal • HIGH signal 	≤ 1 mA 2.5 through 7.5 mA	
Switching threshold <ul style="list-style-type: none"> • LOW → HIGH • HIGH → LOW 	13.2 V 9.1 V	
Input delay <ul style="list-style-type: none"> • LOW → HIGH • HIGH → LOW 	3 ms 3 ms	
Cable length	max. 100 m, unshielded	
Width	1 slot	
Weight	190 g	210 g
Terminal form factor	5.08	3.5

Ordering information

Designation	Order no.
Input module E 24 V– (16-way)	w/ spring loaded terminals (UL*) 1070 083 383 w/ threaded terminals 1070 075 101
Input module E 24 V– (32-way)	w/ spring loaded terminals (UL*) 1070 083 384 w/ threaded terminals 1070 075 924

*UL = Module w/ Underwriters Laboratories certification

 **UL approved application requires the following connecting cables:**

- Copper cables up to 60 / 75° C
- Only cables conforming to Class 1 or similar.

Notes:

7 Digital Output Modules

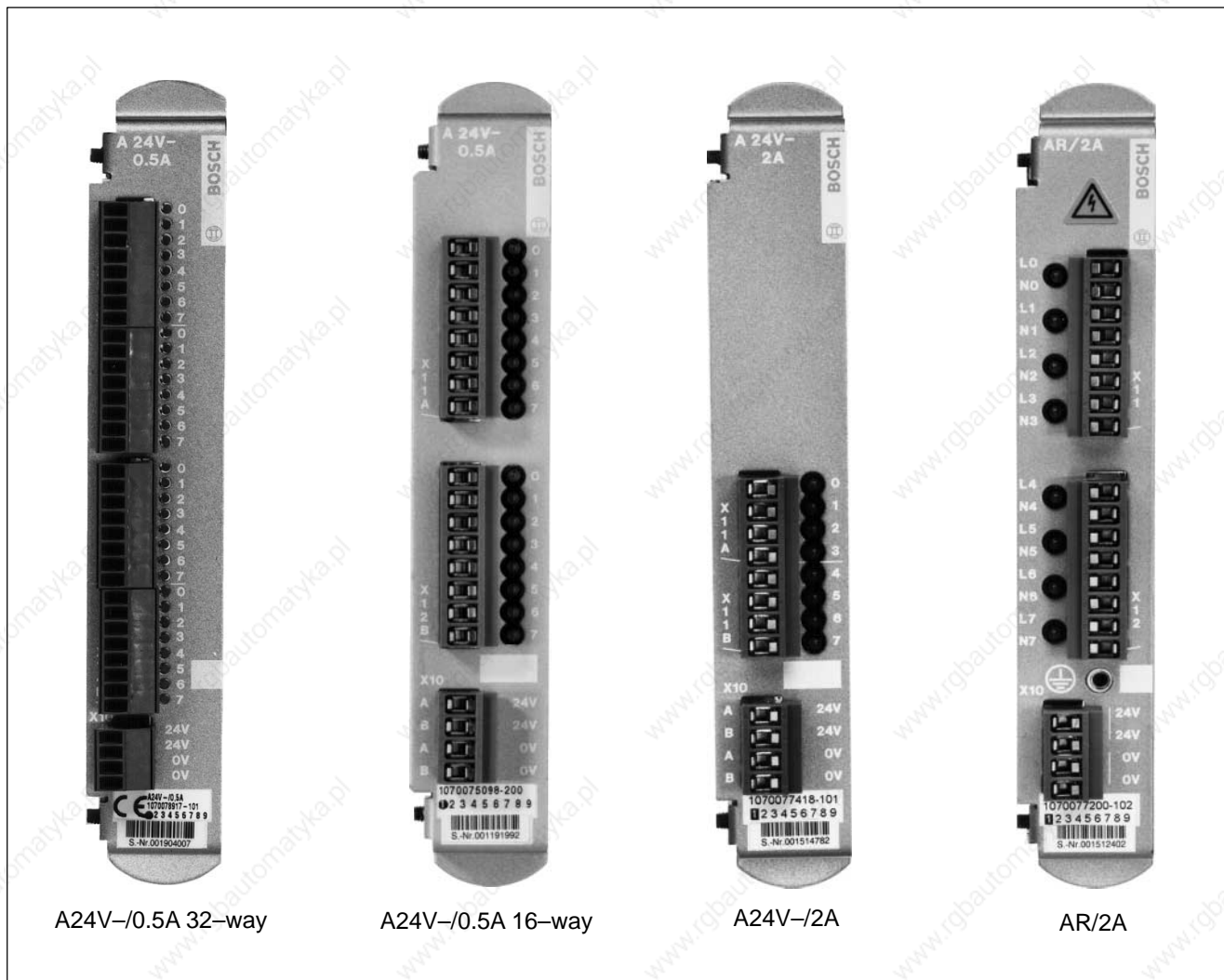

7.1 Features and Functions

Construction

The digital output modules handle a nominal current of 0.5 A or 2 A.

The output signals are electrically isolated from the process signals via optocouplers. Each output module is assigned a light emitting diode for signal status display:

- LED illuminated: HIGH
- LED extinguished: LOW

When cycling power ON and OFF, and/or in the event of a failure of the central processing unit, the digital outputs are switched to logical 0 state (LOW = secure status).

A24V- module slots

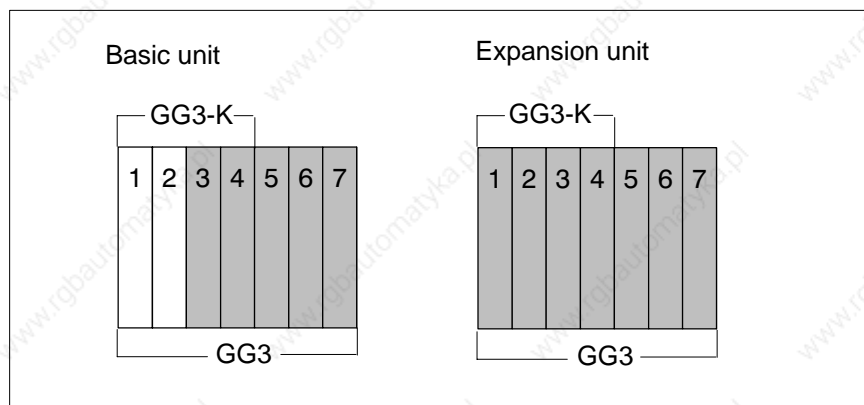
**CAUTION**

Do not insert or remove the module while the controller is switched ON! This may destroy the module. Prior to inserting or removing the module, ensure that module is not energized!

**CAUTION**

Do not insert or remove the module while there is power applied (to digital outputs)! This may destroy the module. Prior to inserting or removing the module, ensure that module is not energized!

**CAUTION**

Risk of module damage!
Observe all ESD protection measures when handling the module!
Prevent electrostatic discharges!

7.2 Connections and Settings

Replacing the fuse

With the exception of the AR/2A, the digital output modules feature two fuses to safeguard the reverse polarity protection of the 24 V power supply.

- ★ Switch OFF power supplies.
- ★ Remove push-lock terminals from front panel of module, and extract module from module rack.

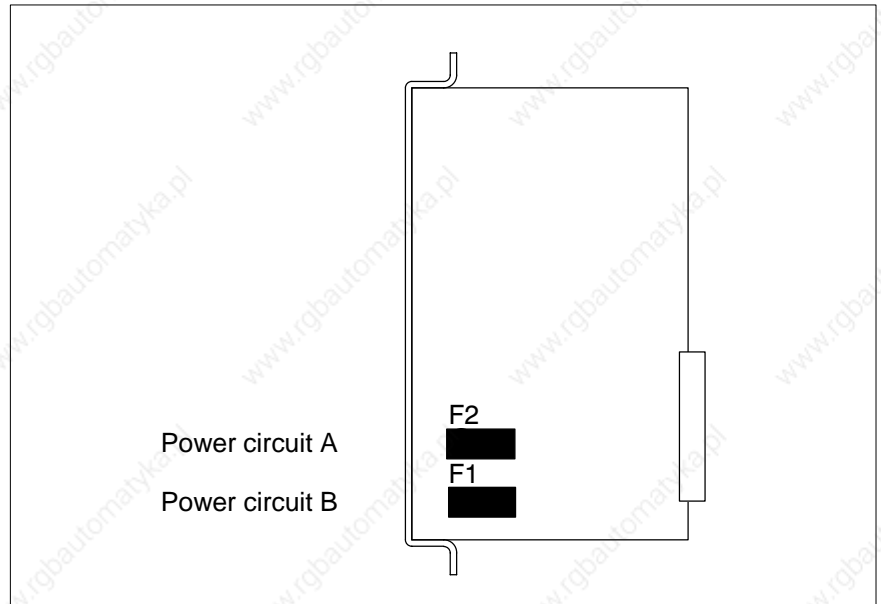

- ★ Using a suitable tool, extract fuse F1 or F2 from socket, then insert new 3.0 A FF fuse. The fuse is supplied complete with fuse holder.
- ★ Insert module in module rack, and push home firmly.
- ★ Reconnect push-lock terminals.
- ★ Switch ON power supply.

Addressing

A start address for each module must be set on the S1 DIP switch:

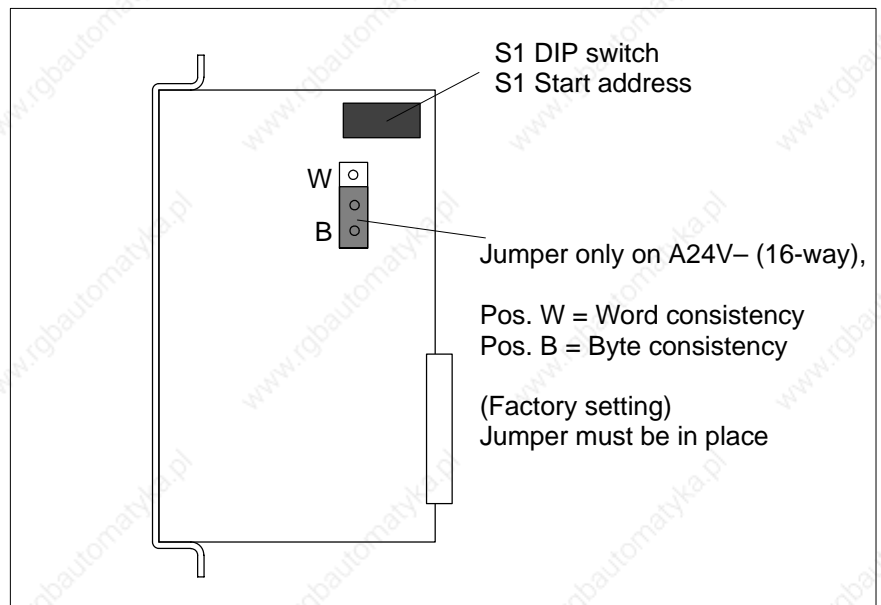

The 8-segment S1 DIP switch is used to select between output (O) and extended output field (EO).

Switch	8	7	6	5	4	3	2	1
Weighting		2^6	2^5	2^4	2^3	2^2	2^1	2^0
Value	O= OFF EO= ON	64	32	16	8	4	2	1

Connection

- Polarity reversal of the 24 V power supply along with a simultaneous short-circuit on one of the outputs will destroy the module.
- Polarity reversal of the 24 V power supply along with the connection of diode-type fuses with rated voltages below 30 V may destroy the module.

Connection via push-lock terminals:

- Max. cable cross-section : 1.5 mm²
- max. terminal current 6 A

The output modules require an external 24 V power supply. Groups of 4, 8, or 16 outputs share a common 24 V and 0 V potential. This makes it possible to feed power to blocks of outputs from separate power supply modules.

Thanks to the low leakage current of 0.5 A, the output can be connected to a Type 1 or Type 2 input conforming to EN 61131-2.

Inductive load at output

Inductive loads such as solenoid valves or contactors must be provided with a damping network directly at the load. Otherwise, any interruption in the line interconnecting an output with an inductive load will generate a high level of interference. In disfavoured circumstances this disturbance may lead to system malfunctions.

A damping network must be present especially in cases where a switch is connected in series with the inductive load (safety interlock).

 **All commercially available damping networks may be utilized.**

For more detailed information, consult the following publication (German-language):

Handbuch zur Entstörung von geschalteten Induktivitäten (Manual: "Interference suppression in switched inductances")

Available from:

**Friedrich Lütze GmbH & Co
Abteilung Marketing
Bruckwiesenstraße 17 - 19
D-71384 Weinstadt (Großheppach)
Germany**

7.3 A 24 V– Output Module / 0.5 A (16-way and 32-way)

The general conditions and specifications appearing in section 7.1 apply.

Function

The outputs are short-circuit protected. The electronic short-circuit protection is triggered by a current of typically 1.2 A. Due to thermal load considerations, output loads must not exceed the rated 0.5 A current.

Multiple overloads have no effect because each individual output is overload protected.

The outputs are electronically protected when switching off inductive loads. The voltage peaks are limited to the following values:

- On the A 24 V- / 0.5 A (16-way), to typically –18 V.
- On the A 24 V- / 0.5 A (32-way), to typically –26 V.

The output module designated A 24 V– / 0.5 A (32-way) differs from the companion model A 24 V– / 0.5 A (16-way) in the following:

- Number of digital outputs: 32
- Power supply to the outputs is individual and word-wise.
- Connecting terminals use the 3.5 mm form factor vs. 5.08 mm.

Connection

Output parallelling:

- On the output module A 24 V– / 0.5 A featuring 32 digital outputs, it is possible to parallel-switch 4 outputs per nibble, with a total current of 2 A.
- On the output module A 24 V– / 0.5 A featuring 16 digital outputs, two outputs in each of the areas listed below can be paralleled with a total current of 1 A:
 - X11A0 through X11A3
 - X11A4 through X11A7
 - X12B0 through X12B3
 - X12B4 through X12B7
- At the same time, the respective outputs must also receive a control signal from the PLC program.

There is no electrical connection between the A-outputs and B-outputs on the module. With the prerequisite of having two separate power supplies, this facilitates the separate shutdown of the supply voltage for the A-outputs while the B-outputs remain functional (in an "Emergency-STOP" situation, for example). The output circuit diagram is shown below.

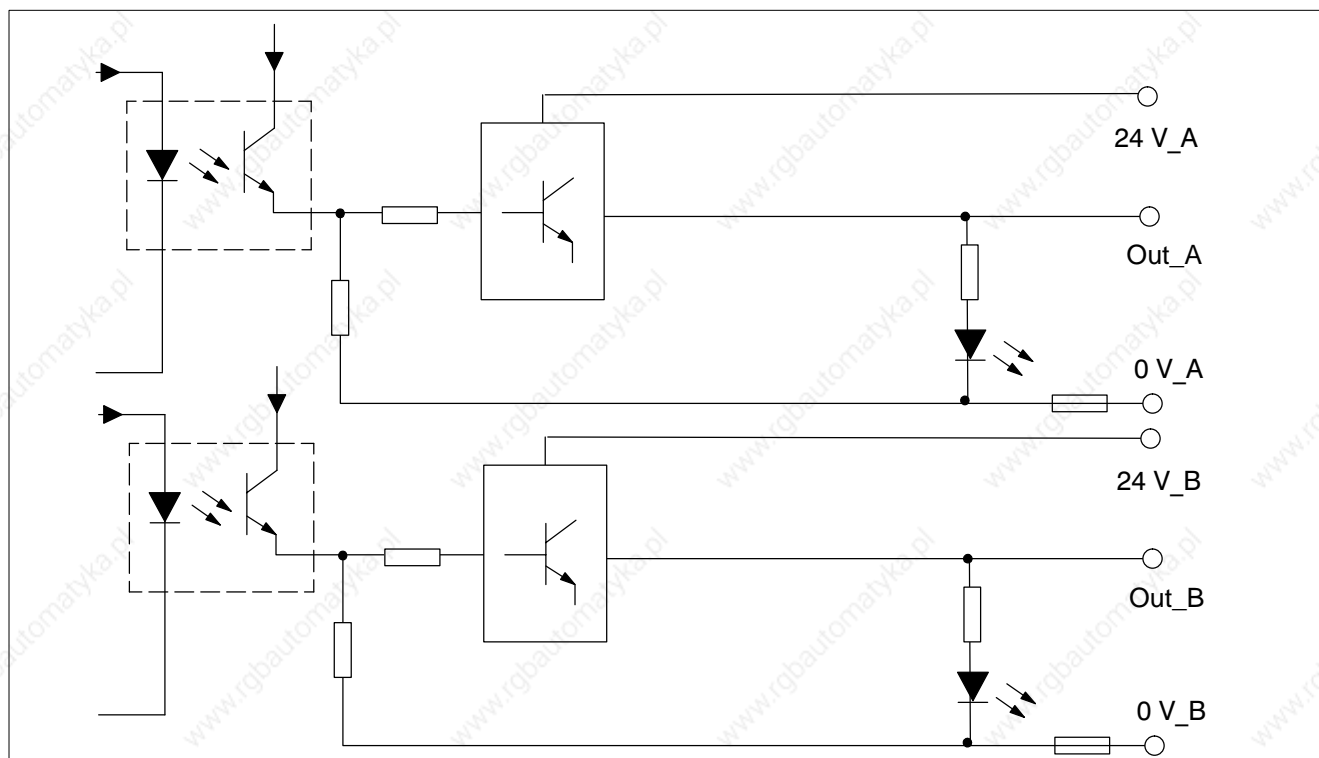

7.4 A 24 V– / 2 A Output Module

The general conditions and specifications appearing in section 7.1 apply.

Function

The outputs are short-circuit protected. The electronic short-circuit protection is triggered by a current of typically 2.4 A. Due to thermal load considerations, output loads must not exceed the rated 2 A current.

Connection

Output parallelling is not permitted.

There is no electrical connection between the A-outputs and B-outputs on the module. With the prerequisite of having two separate power supplies, this facilitates the separate shutdown of the supply voltage for the A-outputs while the B-outputs remain functional (in an "Emergency-STOP" situation, for example). The output circuit diagram is shown below.

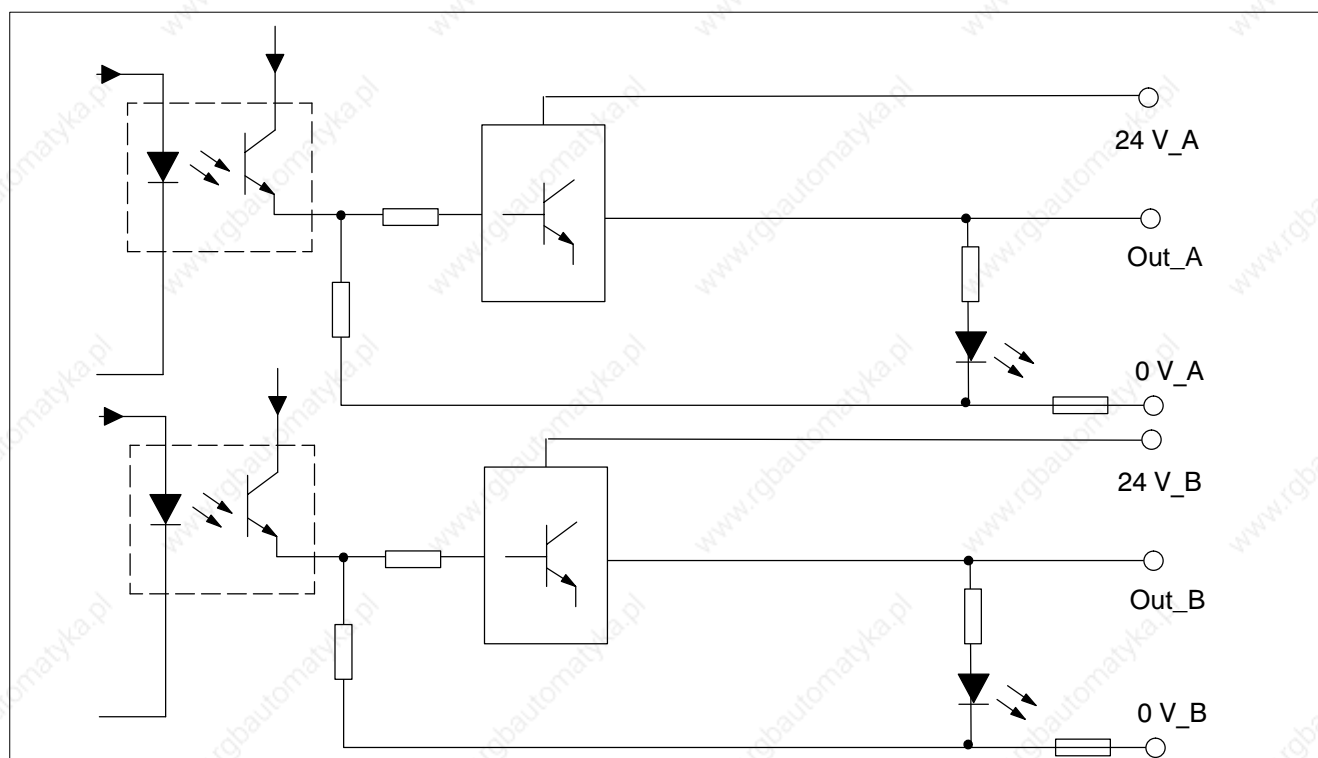

7.5 AR/2A Relay Output module

The general conditions and specifications appearing in section 7.1 apply.

Features

The AR/2A output module provides 8 floating contact assemblies for a rated current of 2 A. The AR/2A meets the requirements of Protective Separation for overvoltage class (ÜK) II, as per EN 50178. Voltages belonging to overvoltage class III may be connected on a given 4-conductor terminal only provided that voltage potentials are effectively separated by a vacant terminal between connections.

Example:

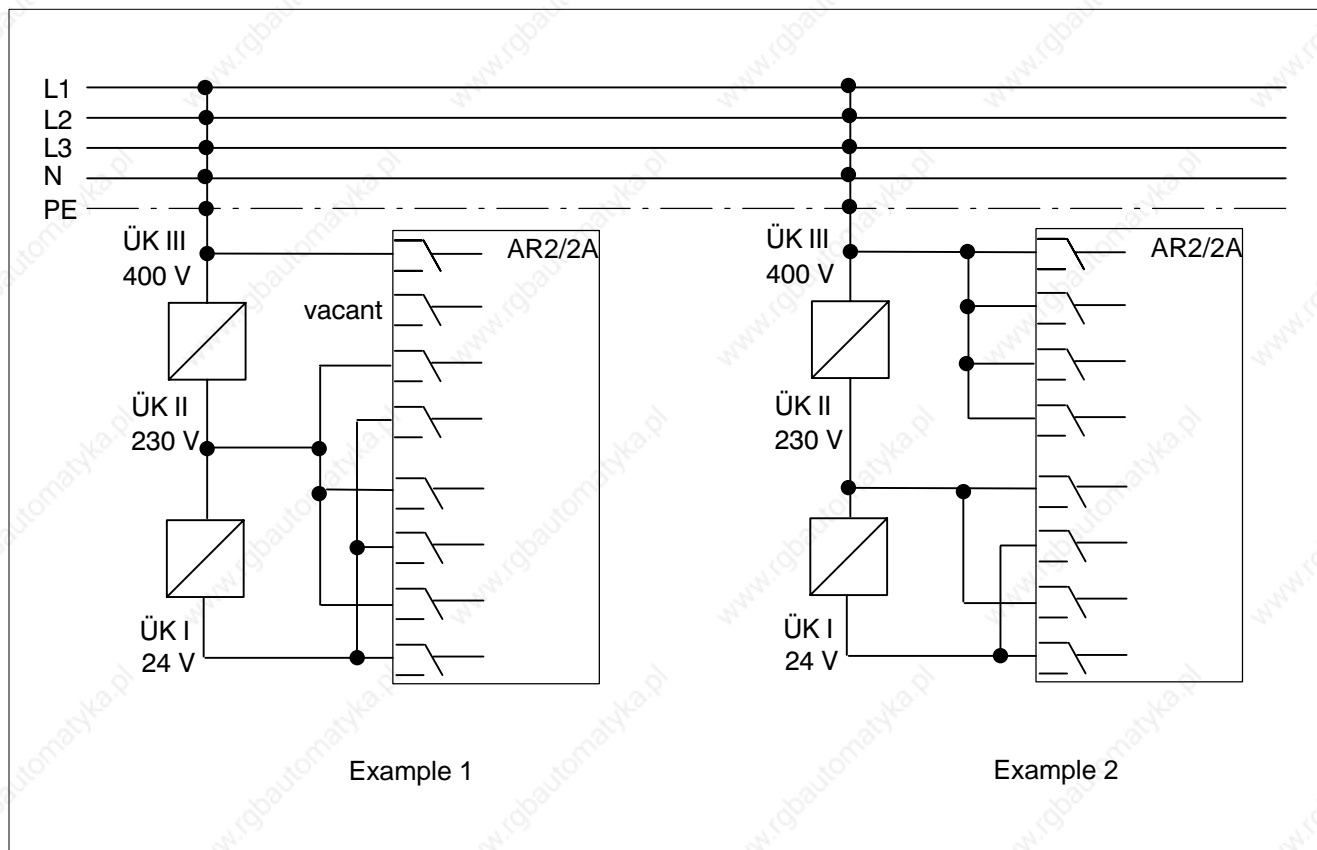

Function

Upon switching off inductive loads, the outputs are not connected electronically but via varistors. The voltage peaks are limited to typically 300 V.



CAUTION

Relay overloading causes damage to switching contact points which can be remedied only through relay replacement. The user is called upon to provide circuit fusing in accordance with rated loads.

Output circuit diagram:

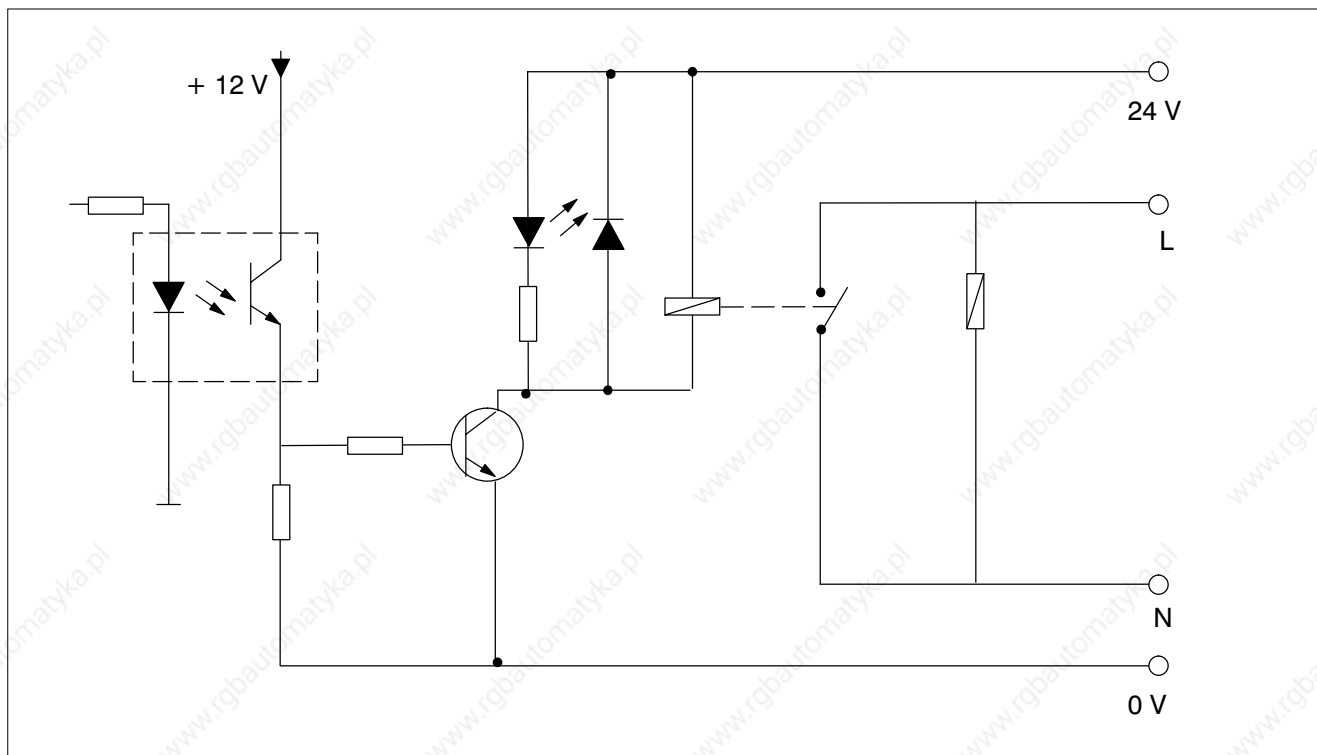

7.6 Specifications

Specifications	A 24 V- / 0.5 A (32-way)	A 24 V- / 0.5 A (16-way)	A 24 V- / 2 A	AR/2 A
Outputs as per EN 61131-2	32 digital outputs, 2 times 16 semi-conductor outputs	16 digital outputs, 2 times 8 semicon-conductor outputs	8 digital outputs, 2 times 4 semicon-conductor outputs	8 floating relay out-puts
Current draw from <ul style="list-style-type: none"> NT200 (7.5 V) RM2-DP12 (7.5 V) 	20 mA + 1.5 mA per enabled output	60 mA	40 mA	38 mA
Current draw from 24 V power supply	15 mA per word + 2.5 mA per enabled output	15 mA per byte + 3 mA per enabled output	7.5 mA per 4 bits + 3 mA per enabled output	10 mA + 13 mA per enabled output
Short-circuit protection	Electronic			No: varistor
Electrical isolation	Yes, via optocoupler			
Insulation test	500 VDC			2500 VDC
Reverse polarity protection for 24 V power supply	Fuse, 3 A FF			Yes
Output voltage <ul style="list-style-type: none"> Rated voltage LOW signal HIGH signal 	24 V- < 40 mV Supply voltage 1.5V	24 V- < 40 mV Supply voltage - 1 V	24 V- < 50 mV Supply voltage - 0.5 V	
Limitation of inductive cut-off voltage	Typically - 26 V	Typically - 18 V		300 V
Output current <ul style="list-style-type: none"> Rated current LOW signal HIGH signal Total current 	0.5 A max. 0.5 mA 2 to 600 mA 2 times 6 A*	0.5 A max. 0.5 mA 2 to 600 mA 2 times 4 A	2 A max. 0.5 mA 4 mA to 6 A 2 times 6 A**	2 A
Lamp load	5 W, at 8 Hz		10 W, at 8 Hz	5 W, at 8 Hz
Max. contactor size	0	1	8	8
Max. switching frequency <ul style="list-style-type: none"> Resistive load Inductive load 	100 Hz 2 Hz			20 Hz 0.1 Hz
Output delay interval TQD <ul style="list-style-type: none"> LOW → HIGH HIGH → LOW 	60 μs 220 μs	40 μs 250 μs	40 μs 550 μs	
Output rise time TQT <ul style="list-style-type: none"> LOW → HIGH HIGH → LOW 	50 μs 10 μs	5 μs 3 μs	8 μs 60 μs	
Relay contacts <ul style="list-style-type: none"> Rated voltage Switching load 	not applicable			250 VAC, 120 VDC 140 W, 500 VA
Closing delay	not applicable			7 ms
Release delay	not applicable			6 ms
Contact bounce	not applicable			1 ms

Specifications	A 24 V- / 0.5 A (32-way)	A 24 V- / 0.5 A (16-way)	A 24 V- / 2 A	AR/2 A
Push-lock terminals Max. cable cross-section Max. terminal current	1.5 mm ² 8 A			
Cable length	max. 200 m, unscreened, max. 300 m, screened	max. 100 m, unscreened		
Width	1 slot			
Weight	280 g	210 g	200 g	290 g
Terminal form factor	3.5		5.08	

*) The maximum total output current and/or simultaneity (diversity) factor per output word at rated operation can be determined with the aid of the derating table below.

In this context, the following should be considered:

- The intake air temperature is measured approx. 3 cm below the module.
- In the case of a typical, multi-row configuration in a switching cabinet (stagnant air), and taking into account the minimum clearances between the rows, the following intake air temperatures may be assumed to exist:
 - Row 1 (basic unit): $T_{\text{intake}} = T_{\text{ambient}}$
 - Row 2 (1st expansion unit): $T_{\text{intake}} = T_{\text{ambient}} + 15\text{ °C}$
 - Row 3 (2nd expansion unit): $T_{\text{intake}} = T_{\text{ambient}} + 25\text{ °C}$

Total load per output word

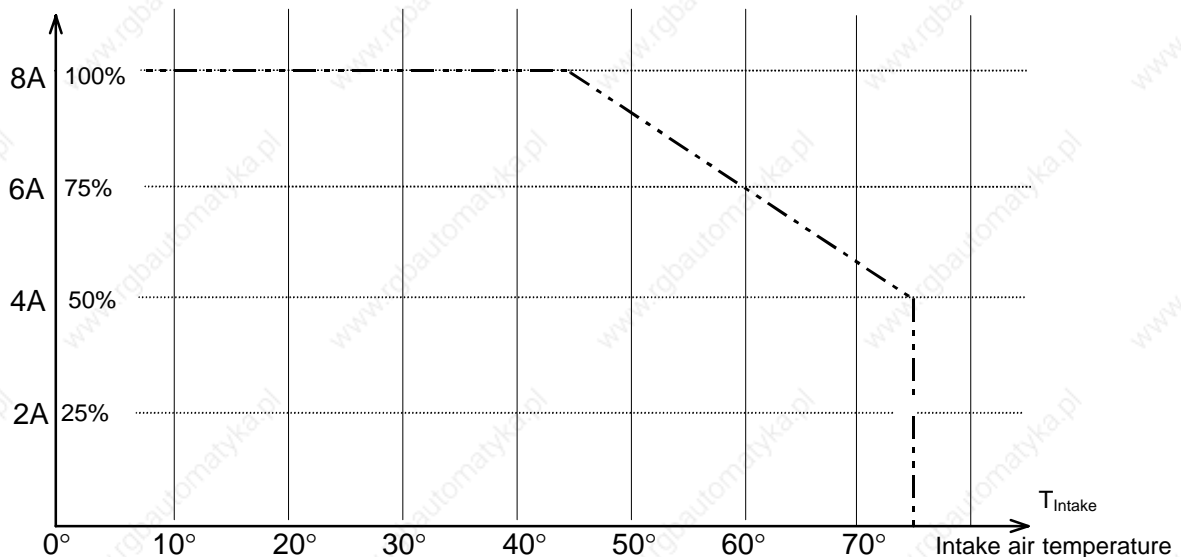

**) A simultaneity (diversity) of 75 % and/or a total current of 6 A applies to multi-row configurations (without limitation of simultaneity or total current as compared to a single-row configuration).

Ordering information

Designation		Order no.
Output module A 24 V- / 2 A (8-way)	w/ spring-loaded terminals (UL*)	1070 083 385
	w/ threaded terminals	1070 077 418
Output module A 24 V- / 0.5 A (16-way)	w/ spring-loaded terminals (UL*)	1070 083 386
	w/ threaded terminals	1070 075 098
Output module A 24 V- / 0.5 A (32-way)	w/ spring-loaded terminals (UL*)	1070 083 387
	w/ threaded terminals	1070 078 917
Output module AR/2A (8-way)	w/ spring-loaded terminals (UL*)	1070 083 596
	w/ threaded terminals	1070 077 200
Fuse 3.0 A, FF		1070 917 937

*UL = Module with Underwriters Laboratories certification.

 **UL approved application requires the following connecting cables:**

- **Copper cables up to 60 / 75°C**
- **Only cables conforming to Class 1 or similar**

8 Digital Input/Output Modules

8.1 Functions and Features

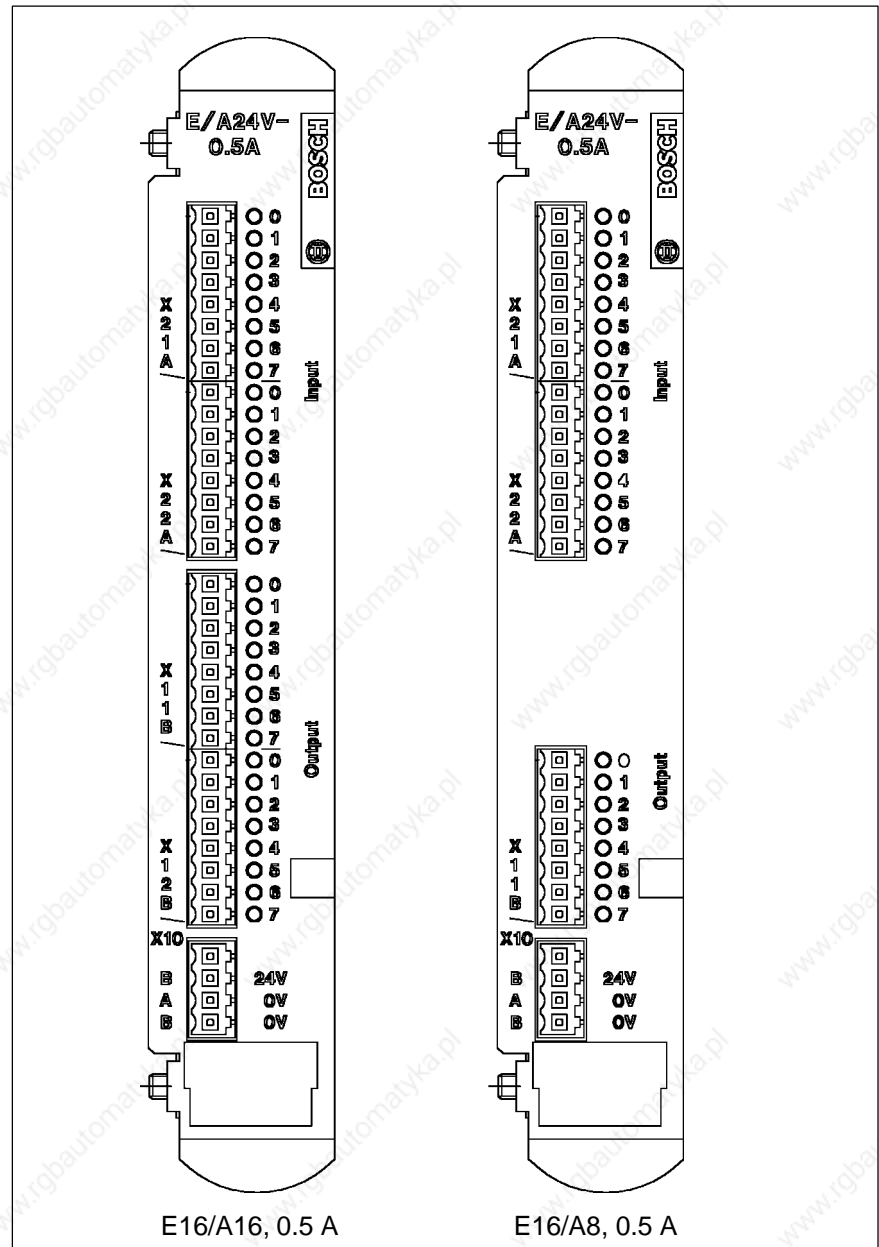

Both input/output modules provide 16 digital inputs each, and 8 and 16 digital outputs, respectively. The rated current for each input or output is 0.5 A.

Both input and output signals are electrically isolated from the logic circuits via optocouplers. Each output and each input is assigned a light emitting diode for signal status display:

- LED illuminated: HIGH
- LED extinguished: LOW

The input signals are interpreted dynamically.

When cycling power ON and OFF, and/or in the event of a failure of the central processing unit, the digital outputs are switched to logical 0 state (LOW).

Module slots

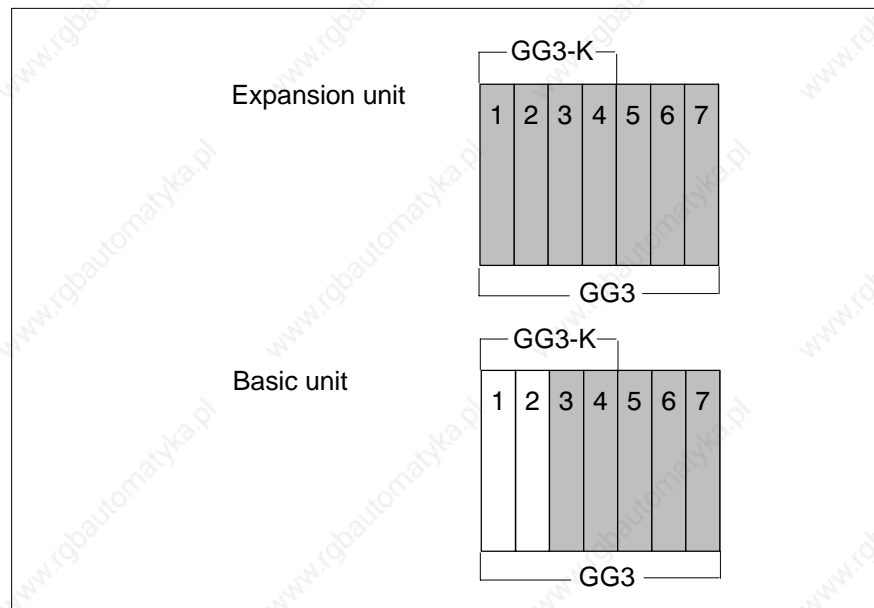
**CAUTION**

Do not insert or remove the module while the controller is switched ON! This may destroy the module. Prior to inserting or removing the module, ensure that module is not energized!

**CAUTION**

Do not insert or remove the module while there is power applied (to digital outputs)! This may destroy the module. Prior to inserting or removing the module, ensure that module is not energized!

**CAUTION**

Risk of module damage!

Observe all ESD protection measures when handling the module!
Prevent electrostatic discharges!

8.2 Addressing

☞ Each of the two input/output module variants always occupies 2 bytes inputs and 2 bytes outputs in the PLC address field.

A start address for each module must be set on the S1 DIP switch:

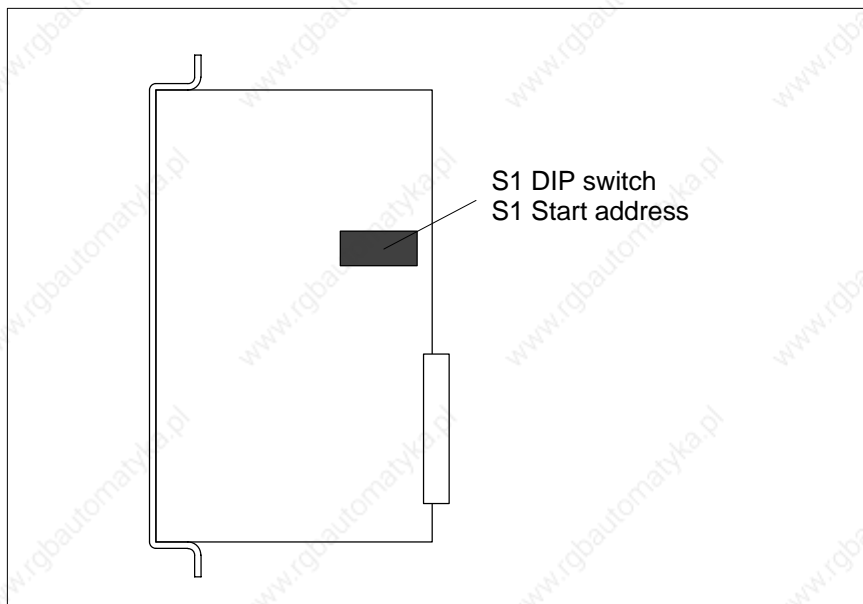

The 8-segment S1 DIP switch is used to select between input (I) and output (O), and between extended input field (EI) and extended output field (EO).

Switch	8	7	6	5	4	3	2	1
Weighting		2^6	2^5	2^4	2^3	2^2	2^1	2^0
Value	I/O= OFF EI/EO= ON	64	32	16	8	4	2	1

8.3 Connection

Connection via push-lock terminals:

- Max. cable cross-section : 1,5 mm²
- Max. terminal current : 8 A
- Polarity reversal of the 24 V power supply along with a simultaneous short-circuit on one of the outputs will destroy the module
- Polarity reversal of the 24 V power supply along with the connection of diode-type fuses with rated voltages below 30 V may destroy the module.

8.3.1 X10 Power Terminals

The external 24 V power supply is connected, separately for inputs and outputs, to the X10 power terminal.

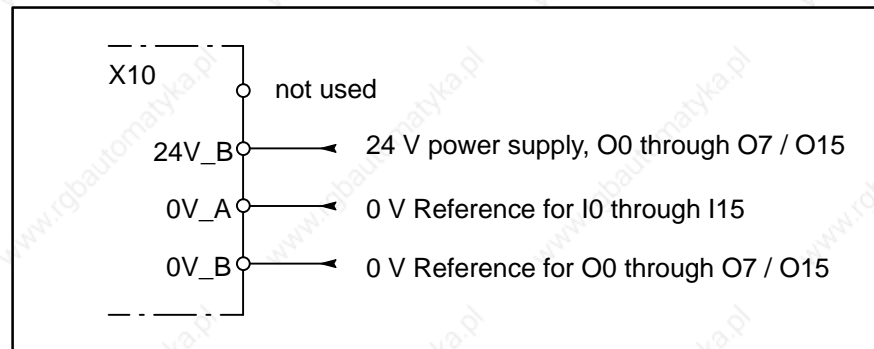

The inputs and outputs are separately powered via the X10 plug connector, each with 0V_A (0 V reference for input circuits – A), plus 24V_B and 0V_B (24 V power supply and 0 V reference for output circuits– B). There is no electrical connection on the module between input and output circuits. For this reason, and provided that there are two separate power supplies, the outputs can be disabled in an Emergency-STOP situation, for example, leaving the inputs functional. It is however possible, to operate both inputs and outputs on a common power supply.

8.3.2 X21A, X22A Inputs

All of the 16 inputs share a common 24 V and 0 V potential. An input can be connected to an output without additional load.

Any 2-wire proximity switch meeting the following requirements can be connected:

- Closed-circuit current $\leq 2,6$ mA
- Voltage drop ≤ 6 V
- Holding current refer to input characteristic

The following cannot be connected:

- 2-wire proximity switches that largely exploit the IEC 947-5-2 standard.
- 2-wire proximity switches (NAMUR standard).

Input circuit diagram

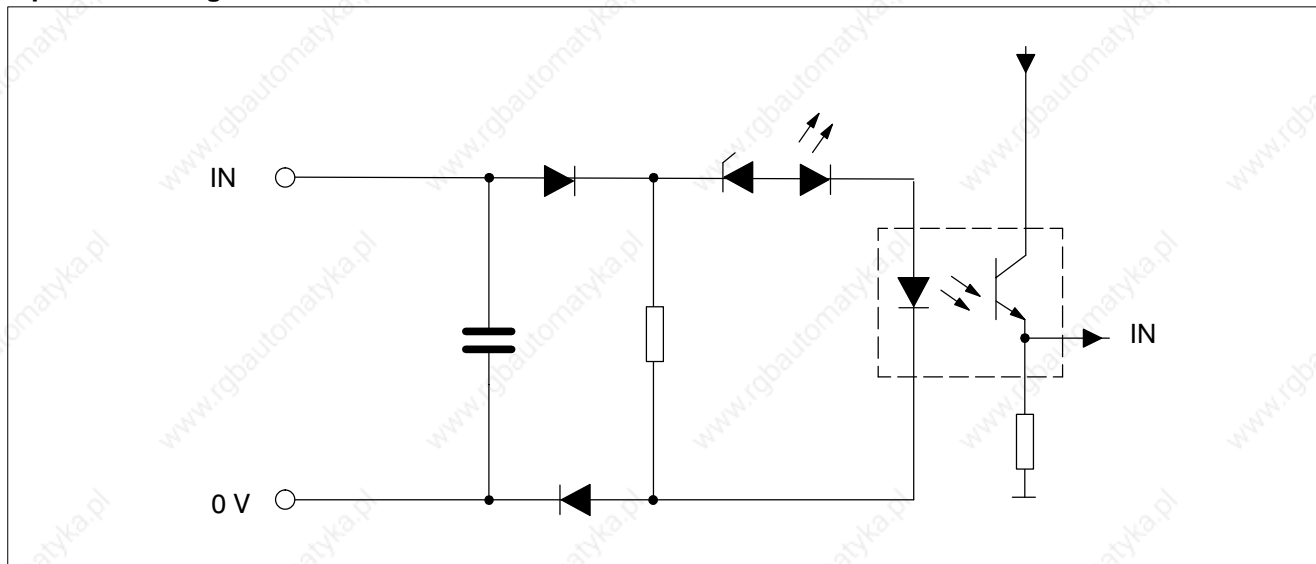

Input characteristic

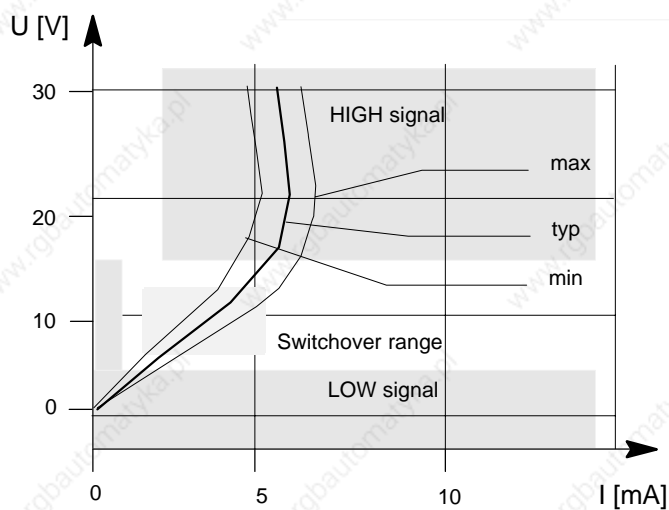

8.3.3 X11B, X12B Outputs

All outputs share a common 24 V and 0 V potential.

Thanks to the low leakage current of 0.5 A, an output can be connected to an input.

The outputs are protected against short-circuit and overtemperature. A current in excess of 0.6 A triggers the electronic monitor, switching off only the faulty output. Once the cause of the fault has been removed, the output will again be enabled automatically.

A short-circuit is indicated by the output LED which remains extinguished although the output has been enabled by the PLC.

Groups of up to four outputs can be paralleled within the following ranges to a total current of up to 2 A:

- X11B0 through X11B3
- X11B4 through X11B7
- X12B0 through X12B3
- X12B4 through X12B7

Output circuit diagram:

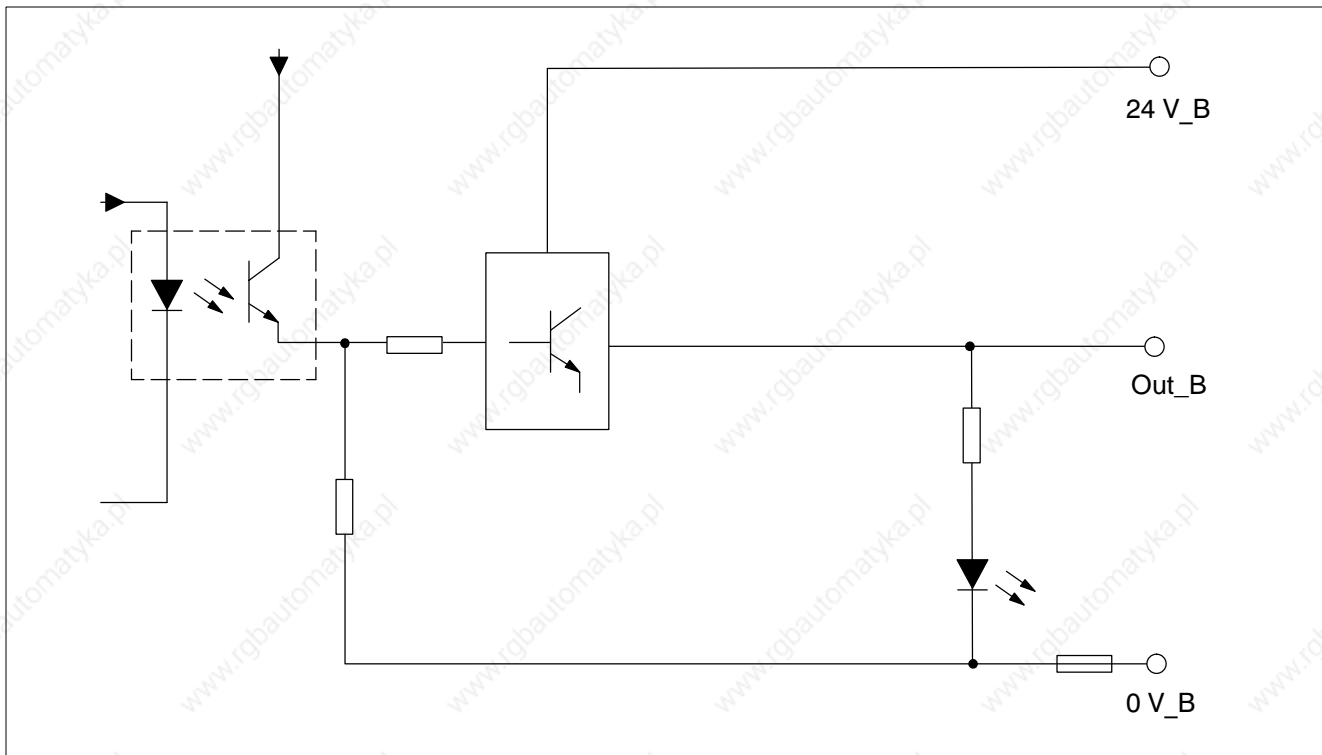

Inductive load at output

Inductive loads such as solenoid valves or contactors must be provided with a damping network directly at the load. Otherwise, any interruption in the line interconnecting an output with an inductive load will generate a high level of interference. In disfavoured circumstances this disturbance may lead to system malfunctions.

A damping network must be present especially in cases where a switch is connected in series with the inductive load (safety interlock).

 **All commercially available damping networks may be utilized.**

For more detailed information, consult the following publication
(German-language):

**Handbuch zur Entstörung von geschalteten Induktivitäten (Manual:
“Interference suppression in switched inductances”)**

Available from:

**Friedrich Lütze GmbH & Co
Abteilung Marketing
Bruckwiesenstraße 17 - 19
D-71384 Weinstadt (Großheppach)
Germany**

8.4 Specifications

Specifications	E16/A16- 0.5 A	E16/A8- 0.5 A
Power supply	external 24 VDC (19.2...30 V)	
Current draw from <ul style="list-style-type: none"> PLC power supply NT200 (7.5 V) 24 V power supply (inputs & outputs w/ separate power) 	25 mA + 1.5 mA per enabled output + 0,5 mA per enabled input 12 mA at idle	8 mA at idle
Insulation test	500 VDC	
Inputs, as per EN 61131-2	16 digital inputs, Type 1	
Electrical isolation	Yes, via optocoupler	
Reverse polarity protection	Yes, for inputs, outputs, and power supply	
Rated voltage	24 VDC	
Input voltage <ul style="list-style-type: none"> LOW signal HIGH signal 	-3 to +5 V 11 to 30 V	
Input current <ul style="list-style-type: none"> LOW signal HIGH signal 	≤ 2.6 mA 3.2 to 8 mA	
Switching threshold <ul style="list-style-type: none"> LOW → HIGH HIGH → LOW 	8.1 V 7.8 V	
Input delay <ul style="list-style-type: none"> LOW → HIGH, and HIGH → LOW 	4 ms	
Outputs, as per EN 61131-2	16 semiconductor outputs, non-latching	8 semiconductor outputs, non-latching
Short-circuit protection	Electronic	
Electrical isolation	Yes, via optocoupler	
Output voltage	24 VDC, voltage drop upon HIGH signal: ≤ 1.5 V	
Output current <ul style="list-style-type: none"> Rated current LOW signal HIGH signal Total current 	0.5 A max. 0.5 mA 2 to 600 mA 8 A	0.5 A max. 0.5 mA 2 to 600 mA 4 A
Concurrency <ul style="list-style-type: none"> For intake air temperature ≤ 45°C For intake air temperature ≤ 55°C 	100 % 85 %	100 % 100 %
Lamp load	5 W, at 8 Hz	
Limitation of inductive cut-off voltage	Typically – 26 V	
Max. switching frequency <ul style="list-style-type: none"> Resistive load Inductive load 	100 Hz Function (contactor)	
Output delay interval TQD <ul style="list-style-type: none"> LOW → HIGH HIGH → LOW 	60 μs 200 μs	

Specifications	E16/A16- 0.5 A	E16/A8- 0.5 A
Output rise time TQT		
• LOW → HIGH	50 µs	
• HIGH → LOW	10 µs	
Contact size	6.2 W	
Push-lock terminals		
Max. cable cross-section	1.5 mm ²	
Max. terminal current	8 A	
Cable length	200 m unscreened, 300 m screened	
Width	1 slot	
Weight	280 g	
Terminal form factor	3.5	

Ordering information

Designation		Order no.
Input / Output module E16/A8- 0.5 A	w/ spring-loaded terminals	1070 083 599
	w/ threaded terminals	1070 081 376
Input / Output module E16/A16- 0.5 A	w/ spring-loaded terminals (UL*)	1070 079 452
	w/ threaded terminals	1070 081 661

*UL = Module with Underwriters Laboratories certification.

 **UL approved application requires the following connecting cables:**

- Copper cables up to 60 / 75° C
- Only cables conforming to Class 1 or similar

Notes:

9 DP-EA4 Peripheral Bus Station Module

9.1 Features and Functions

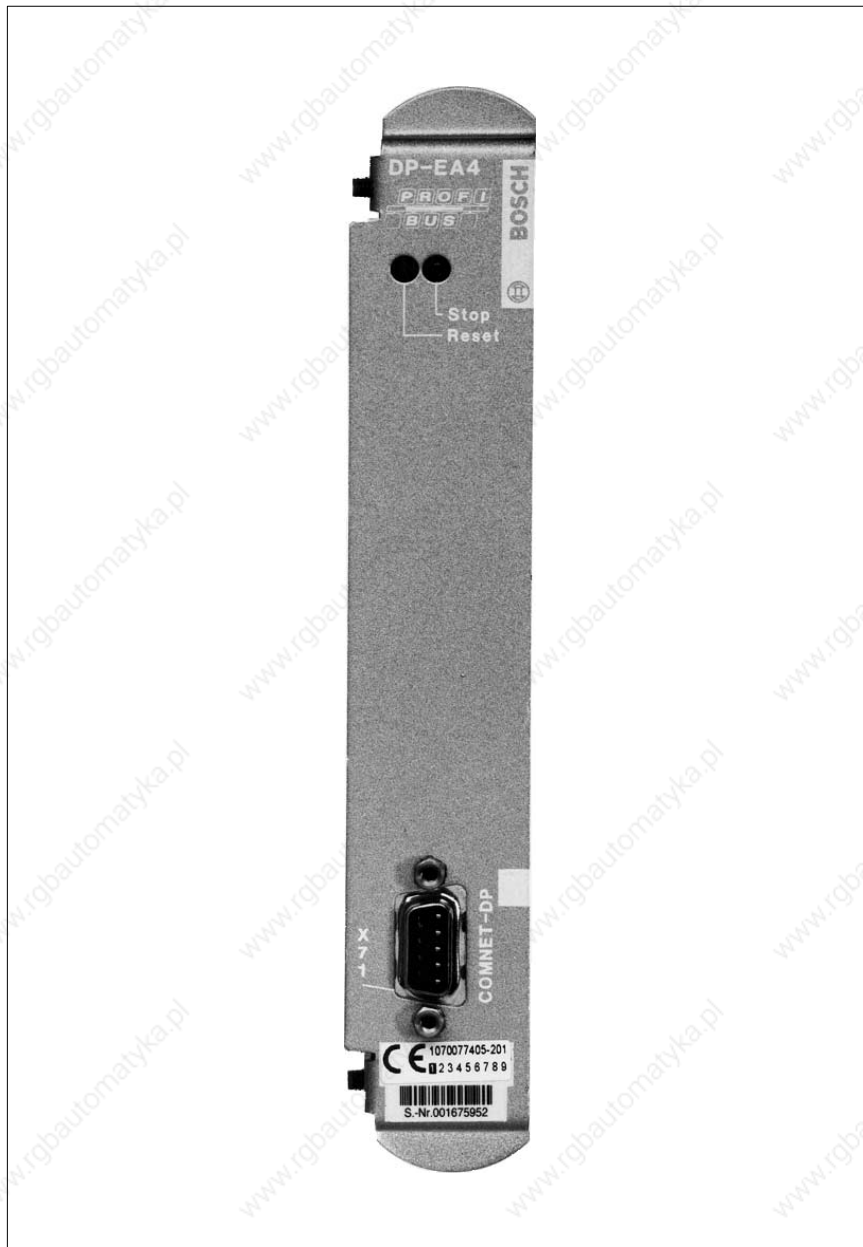

The DP-EA4 peripheral bus station module provides the option to operate a CL200 controller as a bus station (slave) on the PROFIBUS-DP field bus. The module is addressed on the peripheral bus of the controller just like any standard digital input / output module.

Once the CL200 has been powered up (7.5 V peripheral bus), the module performs an automatic startup routine and then awaits initialization of the DP-Master.

The DP-EA4 peripheral bus station module provides 4 bytes for inputs (from the vantage point of the PROFIBUS-DP Master, these are the outputs of the slave), and 4 bytes for inputs (from the vantage point of the PROFIBUS-DP Master, these are the inputs of the slave).

☞ **The assignment within the bus master system is accomplished by appropriately configuring the bus master file.**

Module slots



CAUTION
Only vertical installation is permitted.

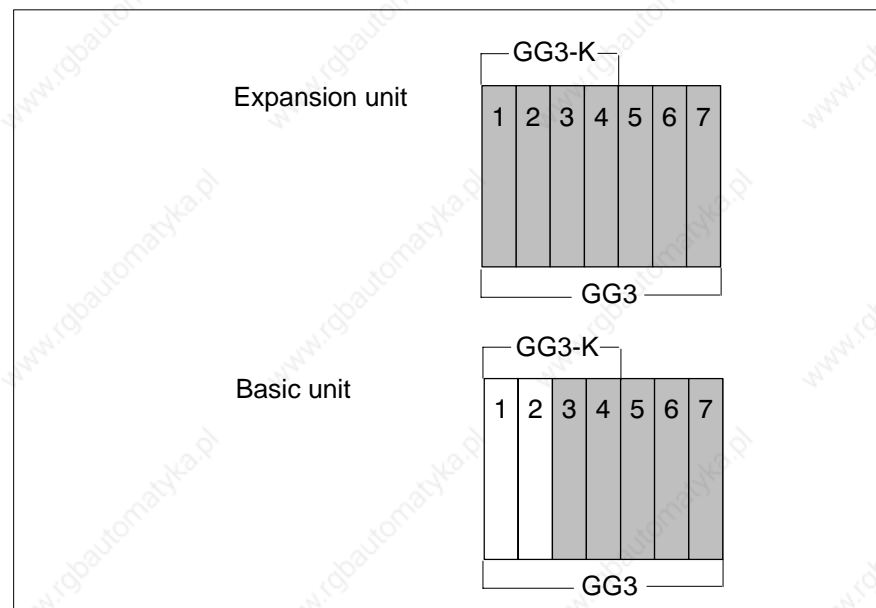

CAUTION
Risk of module damage!
Do not insert or remove the module while the controller is switched ON! This may destroy the module. Prior to inserting or removing the module, ensure that module is not energized!



CAUTION
Risk of module damage!
Observe all ESD protection measures when handling the module!
Prevent electrostatic discharges!

9.2 Display and Control Elements, Connections and Settings

Diagnostics

The “Stop” LED indicates the operating status of the DP ring.

- LED extinguished: Normal operating status
- LED illuminates: Fault in DP operation

Pressing the RESET button triggers a hardware RESET. The module will subsequently attempt to reestablish a new DP connection.

PROFIBUS-DP connection

The PROFIBUS-DP connection uses a female DB-9 connector.

DP addressing

The PROFIBUS-DP slave address is selected on the 8-segment S1 DIP switch.

S1 switch	8	7	6	5	4	3	2	1
Weighting	27	26	25	24	23	22	21	20
Value	128	64	32	16	8	4	2	1

The major device specification file (GSD file) for this module must be selected in the WinDP configuration software for the PROFIBUS-DP.

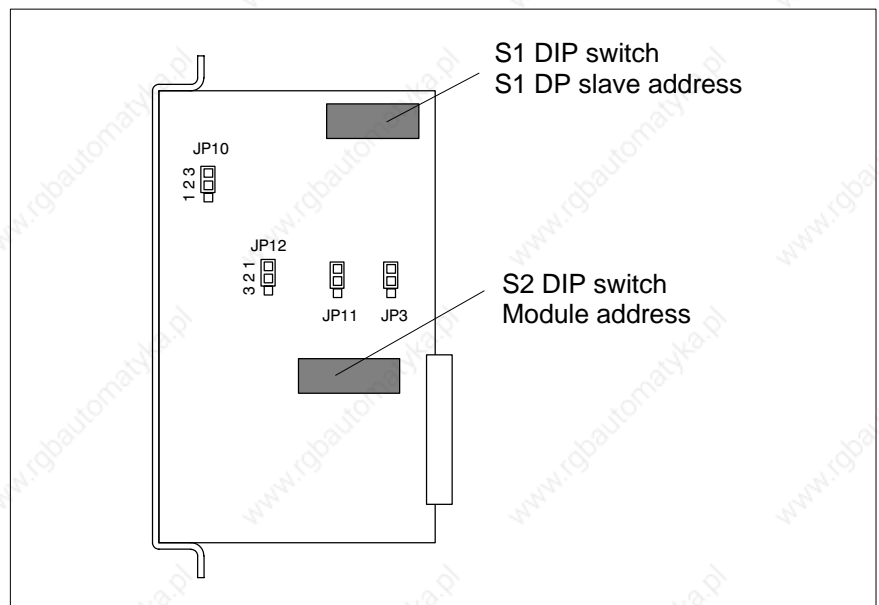

PLC addressing

The DP-EA4 peripheral bus station module occupies 4 input bytes and 4 output bytes in the normal and/or extended input field. The module address is set on the 8-segment S2 DIP switch.

The switch segments 1 through 8 are used to select between the input ranges (I) / output ranges (O) or extended input range (EI) or extended output range (EO).

S2 switch	8	7	6	5	4	3	2	1
Weighting		2 ⁶	2 ⁵	2 ⁴	2 ³	2 ²	2 ¹	2 ⁰
Value	E/A=OFF EI/EO=ON	64	32	16	8	4	2	1

Consistency setting

Jumper JP3 is used to select consistent or non-consistent data transmission (Consistency / No Consistency).

 **The selected operating mode must also be appropriately set in the DP master configuration.**

In the event that there is no real need to utilize the consistency of the entire 4-byte data block, the jumper JP3 should be positioned to the No Consistency setting. Taken by themselves, values of individual bytes are not always consistent.

Jumper	Position 1–2	Position 2–3
JP3	Consistency	No Consistency

 **In the event that data consistency has been selected, an ascending addressing succession must be used when reading and writing in the normal or extended address field.**

Control signals

Whenever required, control signals can be appended to the topmost output or input byte by setting jumpers JP10, JP11, and JP12.

- Information for DP slave PLC:
JP10: NORMOPER signal
(appended to input signal I3.7)
0 = Profibus not operating
1 = Profibus operation OK
- Information for DP master PLC:
JP11: CLAB signal
(appended to output signal O3.7)
0 = CLAB enabled in SLAVE-SPS
1 = CLAB disabled in SLAVE-SPS
- CLAB (Clear All Bytes) is HIGH:
 - when cycle time is exceeded
 - in Stop mode
 - when outputs are disabled
 - when set by intelligent module
- JP12: RUN signal
(appended to output signal O3.6)
0 = Slave PLC in STOP mode
1 = Slave PLC is operating

Jumper	Position 1–2 (default)	Position 2–3
JP10	Data line I3.7	NORMOPER
JP11	Data line O3.7	CLAB
JP12	Data line O3.6	RUN

9.3 Specifications

Specifications	DP-EA4
Inputs	4 bytes
Outputs	4 bytes
External power supply	None
Power supply	7.5 V from NT200 PLC power supply
Current draw	typ. 270 mA + max. 120 mA for RS-485 interface
Interfaces	PROFIBUS-DP w/ RS-485
Isolated potential	Yes, optocoupler
Width	1 slot
Weight	300 g

Ordering information

Designation	Order no.
DP-EA4 Peripheral bus station module	1070 077 405

Notizen:

10 AG/S Expansion Module

10.1 Features and Functions

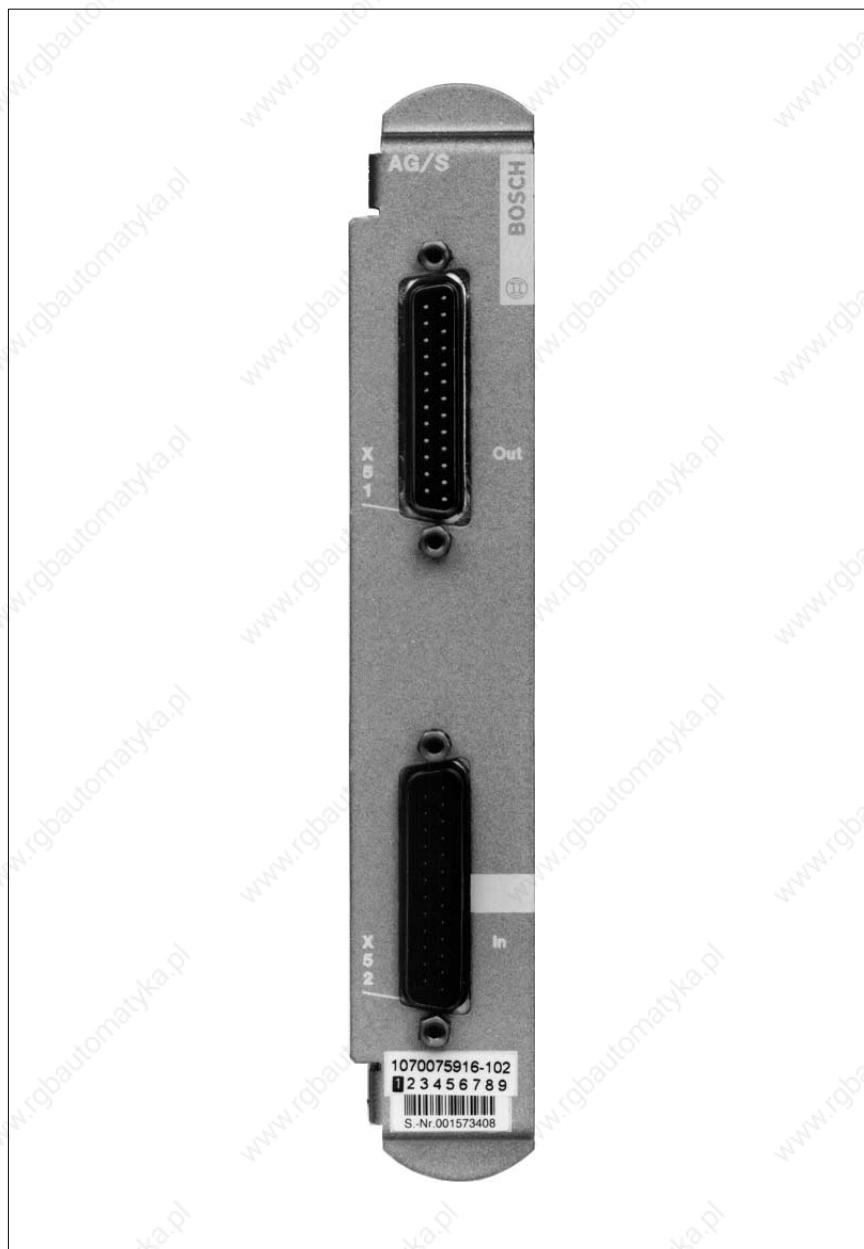

The AG/S expansion module facilitates an expansion of the controller to more than two module racks, or to configure multi-row arrangements.

The connection must always start at the basic unit (row), and progress from there to the expansion rows. IN and OUT plug connectors must not be confused. The IN connector in the basic row must be vacant at all times. Installing intelligent modules in the expansion rows is not permitted.

X51 connector

The X51 connector provides the connection from one row to the next.

X52 connector

The X52 provides the connection between a given row and the previous row. This connector is always vacant in the basic row.

**CAUTION**

Connecting modules must be inserted and connected only while deenergized.

Maximum expansion

The maximum permitted expansion for the entire CL200 comprises 3 rows.

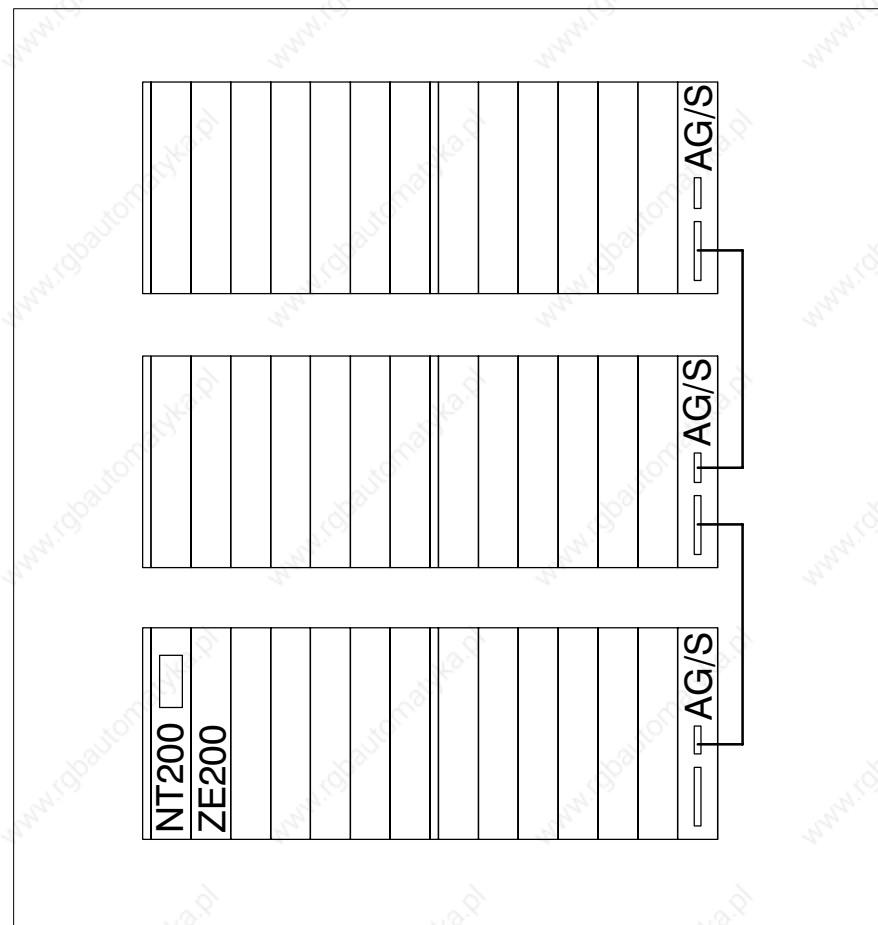

 **When using the AG/S, the distance between two module racks may be up to 5 m.**

10.2 Specifications

Specifications	AG/S
Internal current draw from NT200 (7.5 V)	typ. 15 mA max. 40 mA
Insulation test	500 VDC
Connecting cable	max. 5 m
Width	1 slot
Weight	160 g

Ordering information

Designation	Order no.
AG/S Expansion module	1070 075 916
K18 Connecting cable, 27 x 0.14 mm ² , 0.3 m	1070 077 162
B15 Cable assembly kit, for variable length	1070 077 163
Cable, 27 x 0.14 mm ² , min. 20 m	1070 910 010

Notizen:

11 R200, R200P, COM2-E Communication Modules

11.1 Functions and Features

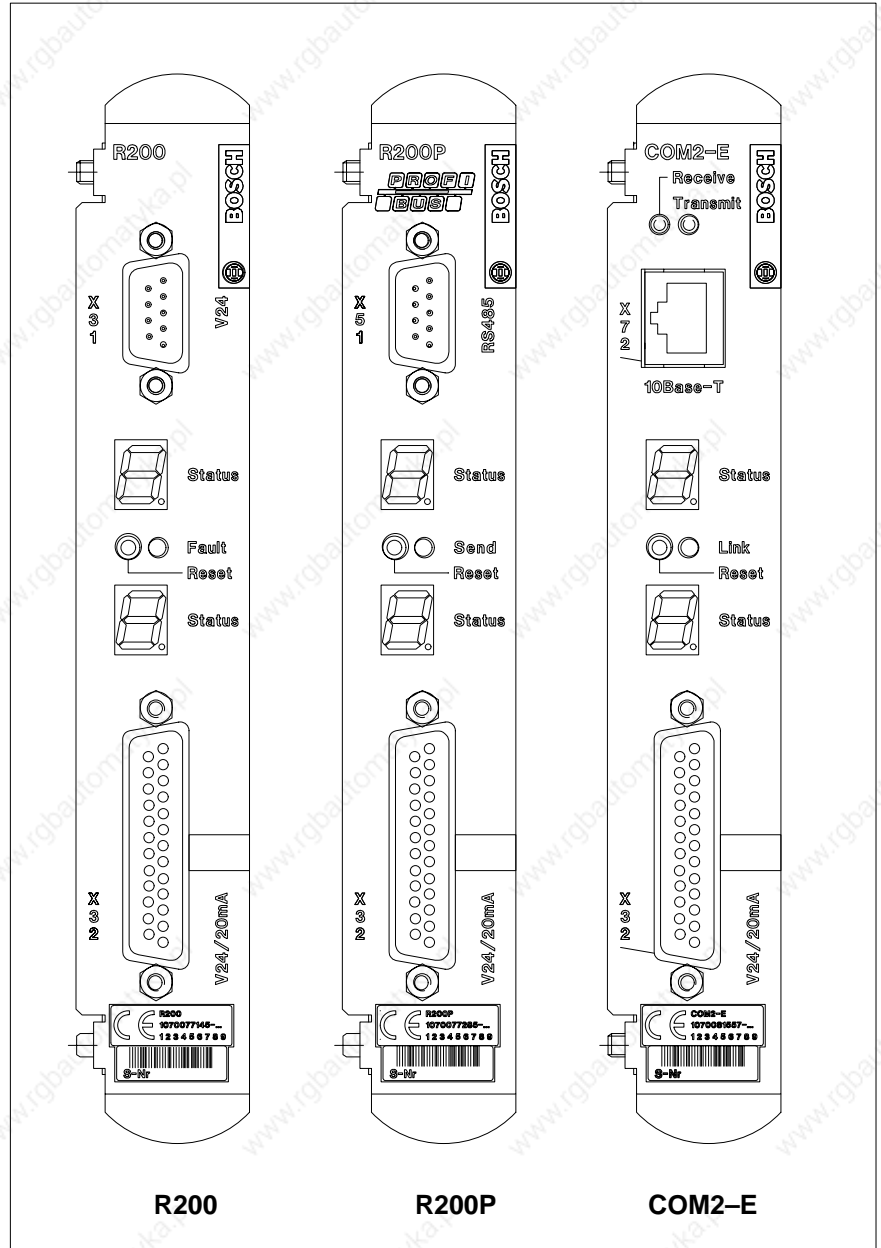

Module variants

Three types of communication modules are available:

- R200 featuring V.24 interface and V.24 / 20 mA combination interface
- R200P featuring RS-485 PROFIBUS interface
- COM2-E featuring Ethernet interface

Max. number in a given controller

A maximum of three communications modules – of one type or of any combination – may be included in the hardware configuration of a single controller.

11.1.1 R200 Communication Module

The R200 communication module comprises one of the CL200 system modules. It is used to connect the CL200 to other Bosch control units and other types of intelligent devices.

Interfaces

The R200 provides two interfaces:

- V.24 interface
- V.24 / 20mA combination interface

Both interfaces can be operated simultaneously, and each interface features its own 7-segment for status indication.

Transmission protocols

The R200 supports the following transmission protocols:

- BUPE19E
- BUPE3E
- BUPE64

The BUPE19E protocol conforms to the DIN 66 019 standard. It controls the data traffic handled via serial interface between programmable memory controllers and peripheral devices. The data interchange transactions are protected against loss of data.

The BUPE03E protocol is a simple ASCII protocol for data transmission via serial interface between programmable memory controllers and peripheral devices.

The BUPE64 protocol is used to handle the data exchange between complex or spatially distributed controller systems.

Connectivity options

On the basis of the listed transmission protocols, the R200 provides the following connectivity options:

- Computer (PC, host computer, etc.)
- CL150, CL200, CL400, CL500

- Scanner
- Printer

Module slots

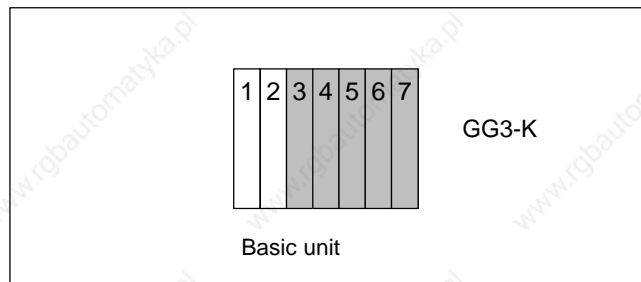

Standard Interfaces function module

With regard to data transmission, a distinction is always made between the requesting station (RST) initiating the protocol request, and the peripheral station (PST) responding to the protocol request. In the event that the R200 communication module in the system is to act as the RST in communications, the integration of the Standard Interfaces function module (order no. 1070 077 901) in the PLC program will be required.

11.1.2 R200P Communication Module

The R200P communication module comprises the PROFIBUS-FMS connection for the CL200. It provides the controller with an extensive variety of networking and communications options via the PROFIBUS-FMS.

Interfaces

The R200P provides two interfaces:

- PROFIBUS-FMS interface
- V.24 / 20mA combination interface

Both interfaces can be operated simultaneously, and each interface features its own 7-segment for status indication.

Transmission protocols

The R200P supports the following transmission protocols:

- PROFIBUS-FMS protocol
- BUEP19E
- BUEP3E
- BUEP64

The PROFIBUS-FMS protocol is an open-standard, manufacturer-independent transmission protocol. It is defined in the EN 50170 standard.

The BUEP19E protocol conforms to the DIN 66 019 standard. It controls the data traffic handled via serial interface between programmable memory controllers and peripheral devices. The data interchange transactions are protected against loss of data.

The BUEP03E protocol is a simple ASCII protocol for data transmission via serial interface between programmable memory controllers and peripheral devices.

The BUEP64 protocol is used to handle the data exchange between complex or spatially distributed controller systems.

Connectivity options

On the basis of the listed transmission protocols, the R200P provides the following connectivity options:

- PROFIBUS-FMS
- Computer (PC, host computer, etc.)
- CL150, CL200, CL400, CL500
- Scanner
- Printer

Module slots

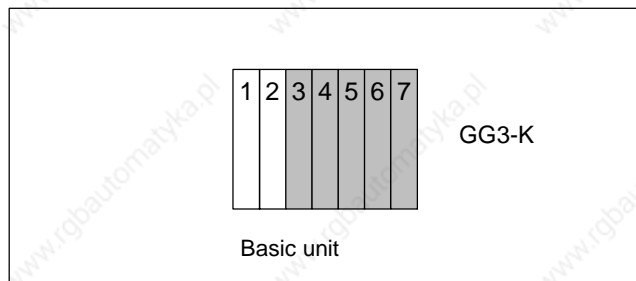

PROFIBUS Configurator

To assist with the comfortable, safe and effective creation of project planning and development data for the PROFIBUS network, the PROFIBUS Configurator software packet (featuring WinDP configuration software, order no. 1070 075 077) can be used with the R200P communication module.

Standard Interfaces function module

With regard to data transmission, a distinction is always made between the requesting station (RST) initiating the protocol request, and the peripheral station (PST) responding to the protocol request. In the event that the R200 communication module in the system is to act as the RST in communications, the integration of the Standard Interfaces function module (order no. 1070 077 901) in the PLC program will be required.

11.1.3 COM2-E Communication Module

The COM2-E communication module comprises one of the CL200 system modules. It is used to connect the CL200 to other Bosch control units and other types of intelligent devices. The COM2-E can also be used in combination with the R200 and R200P in the basic unit of the CL200 controller.

Interfaces

The COM2-E provides two interfaces:

- Ethernet interface (10BaseT)
- V.24 / 20mA combination interface

Both interfaces can be operated simultaneously, and each interface features its own 7-segment for status indication.

Transmission protocols

The COM2-E supports the following transmission protocols:

- TFTP protocol (Trivial File Transfer Protocol)
- BUEP-E
- BUEP19E
- BUEP3E
- BUEP64.

The TFTP protocol (Trivial File Transfer Protocol), specified in accordance with RFC782 dated 1992, provides a PC host computer or UNIX workstation with a simple means of communicating with the controller. Data fields up to 510 bytes in size can be loaded from the controller. Larger fields are not supported. Also, write access to data fields is not available due to security considerations.

BUEP-E is the designation of a protocol used for communication via Ethernet LAN. With regard to the user interface, and with the exception of the IP address and the error codes, BUEP-E is identical to the BUEP19E protocol.

The BUEP19E protocol conforms to the DIN 66 019 standard. It controls the data traffic handled via serial interface between programmable memory controllers and peripheral devices. The data interchange transactions are protected against loss of data.

The BUEP03E protocol is a simple ASCII protocol for data transmission via serial interface between programmable memory controllers and peripheral devices.

The BUEP64 protocol is used to handle the data exchange between complex or spatially distributed controller systems.

Connectivity options

On the basis of the listed transmission protocols, the COM2-E provides the following connectivity options:

- Computer (PC, host computer, etc.)
- CL150, CL200, CL400, CL500

- Scanner
- Printer

Module slots

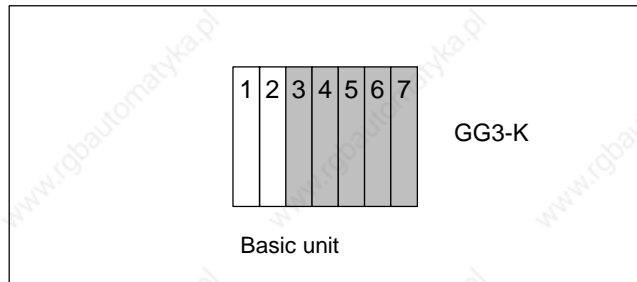

Ethernet address / IP address

Each COM2-E module comes with its own unique Ethernet address. This address is unique in the world, and should not be changed. In addition, to address the module via the Ethernet, an Internet address (IP address) is required. IP addresses are allocated by the network administrator. The IP address may occur only once throughout the connected LAN.

Special function modules

To enable the COM2-E to be addressed from within the PLC program, special function modules must be integrated in the PLC program. The modules are designated R2REQ and R2CON (order no. 1070 077 901).

11.2 Specifications

Specifications	R200	R200P	COM2-E
Order no.	1070 077 145	1070 077 285	1070 080 557
Interfaces	<ul style="list-style-type: none"> • V.24 • V.24 / 20mA 	<ul style="list-style-type: none"> • RS-485 • V.24 / 20mA 	<ul style="list-style-type: none"> • 10BaseT (Ethernet) • V.24 / 20mA
Baud rates <ul style="list-style-type: none"> • RS-485 interface • V.24 / 20mA interface • Ethernet interface 	600 to 57600 baud	9.6 kbaud to 12 Mbaud 600 to 57600 Baud	9.6 kbaud to 12 Mbaud 600 to 57600 Baud max. transmission rate 10 Mbit/s
Current draw I_{Sys}	250 mA without use of 20 mA interface 500 mA with use of 20 mA interface	500 mA	500 mA
Width	1 slot		

11.3 Advanced Documentation

The following manuals are available for the communication modules:

Manual	German, order no.	English, order no.
R200	1070 072 400	1070 072 157
R200P	1070 072 401	1070 072 162

Notizen:

12 Analog Input Modules

12.1 Features and Functions

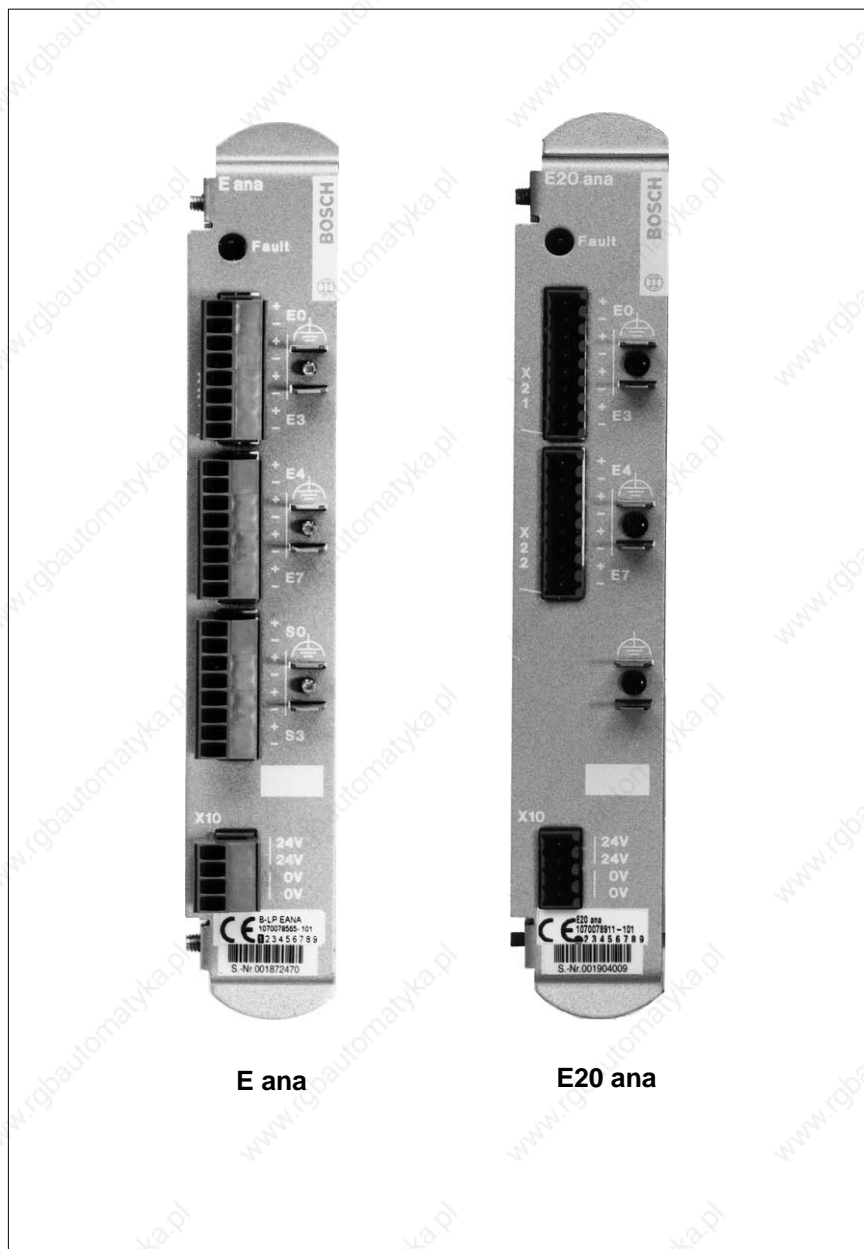

The analog input modules facilitate the preparation of analog process signals for subsequent handling by the CL200.

Module variants

The analog input module is available in two variants:

- E ana w/ 8 isolated-potential differential inputs
- E20 ana w/ 8 power inputs, current rated.

12.1.1 E ana Analog Input Module

The E ana analog input module provides:

- 8 Isolated-potential differential inputs
- 16-bit resolution at 13-bit linearity
- Individually selectable measuring range for all inputs
- Integration of measured values via numerical measurements
- Sensor failure and overrange monitoring
- Voltage measurement in 4 measuring ranges
- Current measurement in 2 measuring ranges
- Temperature measurement via thermocouple
 - Characteristic curve correction
 - compensation
 - Conversion to °C
- Temperature measurement via resistance thermometer
 - Four 2.5 mA stabilized power sources
 - Characteristic curve correction
 - Conversion to °C

Thermocouples

The E ana analog input module supports the following thermocouples defined in the IEC 584 standard: Type B, E, J, K, R, S, T

Both non-floating and potential-free thermocouples with two-wire connections can be connected.

Resistance thermometers

The E ana supports the following resistance thermometers:

- NI100, NI500, NI1000
- PT100, PT500, PT1000.

resistance thermometers are connected via 4, 3 or 2-wire connections.

Byte assignment

The E ana occupies 4 input and 4 output bytes in the EI / EO address range of the CL200.

Signal sources are connected via push-lock terminals.

The input module requires an external 24 V power supply.

12.1.2 E20 ana Analog Input Module

The E20 ana analog input module provides:

- 8 power inputs, current rated
- Built-in 50 Ω shunts
- 2 current measuring ranges
 - 10 through 20 mA
 - 4 through 20 mA
- Sensor failure detection in 4 through 20 mA measuring range

Byte assignment

The E20 ana occupies 4 input and 4 output bytes in the EI / EO address range of the CL200.

Signal sources are connected via push-lock terminals.

The input module requires an external 24 V power supply.

12.2 Specifications

Specifications	E ana	E20 ana
Order no.	1070 078 565	1070 078 911
Inputs	8	8
Isolated potential		Inputs isolated against GND but not against each other.
Voltage measuring range	<ul style="list-style-type: none"> ● ± 10 V ● ± 1 V ● ± 100 mV ● ± 10 mV 	
Input resistance	3.4 MΩ	50 Ω
Current meas. ranges (for E ana w/ external 50 Ω shunt)	<ul style="list-style-type: none"> ● 0 through 20 mA ● 4 through 20 mA 	<ul style="list-style-type: none"> ● 0 through 20 mA ● 4 through 20 mA
Digital resolution	16-bit, straight binary	
Temperature errors	± 0.01 %/°C	
Linearity errors	± 0.05 %	
Current draw	<ul style="list-style-type: none"> ● 7.5 V ex NT200 ● 24 V power supply 	
Push-lock terminal	<ul style="list-style-type: none"> ● Cable cross-section ● Terminal current, max. 	
	max. 1.5 mm ²	
	6 A	
Cable length	max. 200 m, screened	max. 50 m, screened
Width	1 slot	

Suitable module slots

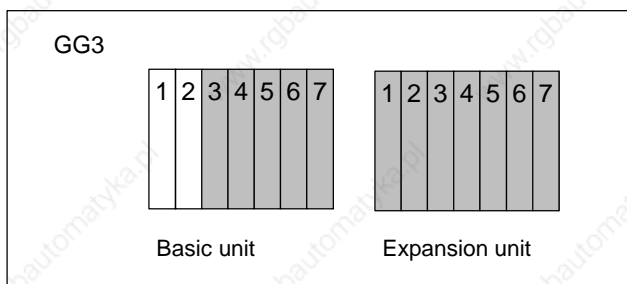

12.3 Advanced Documentation

the following manuals are available for analog input modules:

Manual	German, Order no.	English, Order no.
E ana, E20 ana	1070 072 408	1070 072 164

13 Analog Output Modules

13.1 Features and Functions

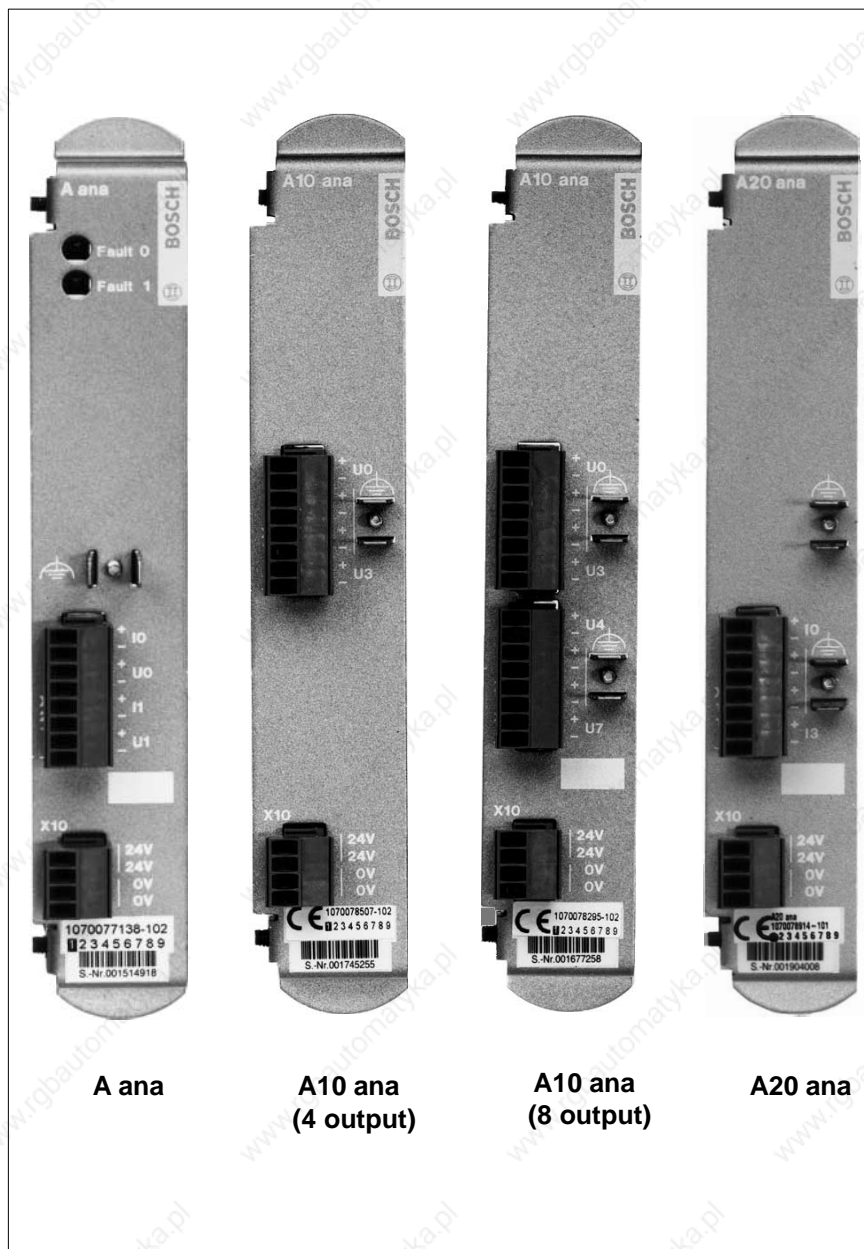

The analog output modules provide control outputs for analog process data signals.

Module variants

The analog output module is available in four variants:

- A ana w/ 2 analog outputs
- A10 ana w/ 4 analog power outputs, voltage rated

- A10 ana w/ 8 analog power outputs, voltage rated
- A20 ana w/ 4 analog power outputs, current rated

13.1.1 A ana Analog Output Module

The A ana output module for the CL200 controller features 2 analog outputs.

The A ana module provides:

- 16-bit resolution
- Current or voltage rated output selectable for each output
- Defective-wire detection on current output
- Short-circuit proof voltage rated power output

Actuators are connected via push-lock terminals.

The output module requires an external 24 V power supply.

13.1.2 A10 ana Analog Output Module

The A10 ana output module for the CL200 features 4 or 8 analog voltage rated power outputs.

The A10 ana module provides:

- 12-bit resolution
- Voltage range, 0 through 10 V

Actuators are connected via push-lock terminals.

The output module requires an external 24 V power supply.

13.1.3 A20 ana Analog Output Module

The A 20 ana analog output module for the CL200 features 4 analog current rated power outputs. With this current ranges, it is particularly designed for applications in environmental technology.

The A20 ana module provides:

- 16-bit resolution
- Current range selectable for each output
- Current ranges
 - 0 through 20 mA
 - 0 through 24 mA
 - 4 through 20 mA

Actuators are connected via push-lock terminals.

The output module requires an external 24 V power supply.

13.2 Specifications

Specifications	A ana	A10 ana (4 outputs)	A10 ana (8 outputs)	A20 ana
Order no.	1070 077 138	1070 078 507	1070 078 295	1070 078 914
Outputs	2	4	8	4
Voltage rated output <ul style="list-style-type: none"> • Voltage range • Load resistance • Short-circuit current 	-10 through +10 V ≥ 1 kΩ 15 mA	0 through 10 V ≥ 1 kΩ		-
Current rated output <ul style="list-style-type: none"> • Current range • Load resistance 	4 through 20 mA ≤ 625 Ω	-		0 through 20 mA 0 through 24 mA 4 through 20 mA ≤ 625 Ω
Setup time, full amplitude	3 ms	Ohmic load: 50 μs Capacitive load: 4 ms		3 ms
Digital mapping	16-bit, straight binary	12-bit, straight binary		16-bit, straight binary
Temperature coefficient				± 0.005 %/K
Current draw from <ul style="list-style-type: none"> • 7.5 V ex NT200 • 24 V power supply 	80 mA 100 mA	60 mA 100 mA	60 mA 200 mA	max. 70 mA max. 200 mA
Push-lock connector <ul style="list-style-type: none"> • Cable cross-section • max. terminal current 	max. 1.5 mm ² 6 A	max. 1.5 mm ²	max. 1.5 mm ²	max. 1.5 mm ²
Cable length	max. 200 m, screened			
Width	1 slot			

Suitable module slots

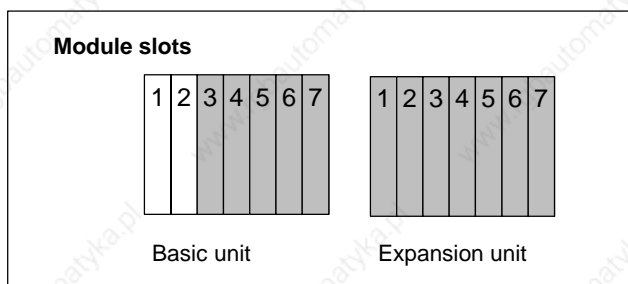

13.3 Advanced Documentation

The following manuals are available for analog output modules:

Manual	German, Order no.	English, Order no.
A ana, A10 ana	1070 072 409	1070 072 165

14 Positioning Modules

14.1 Features and Function

Module variants

To handle positioning tasks, several modules – some with special features – are available:

- Counting / Positioning modules POS-SA1 (1 channel) and POS-SA2 (2 channels)
- Positioning module POS-LR1 (1 channel) and POS-LR2 (2 channels)

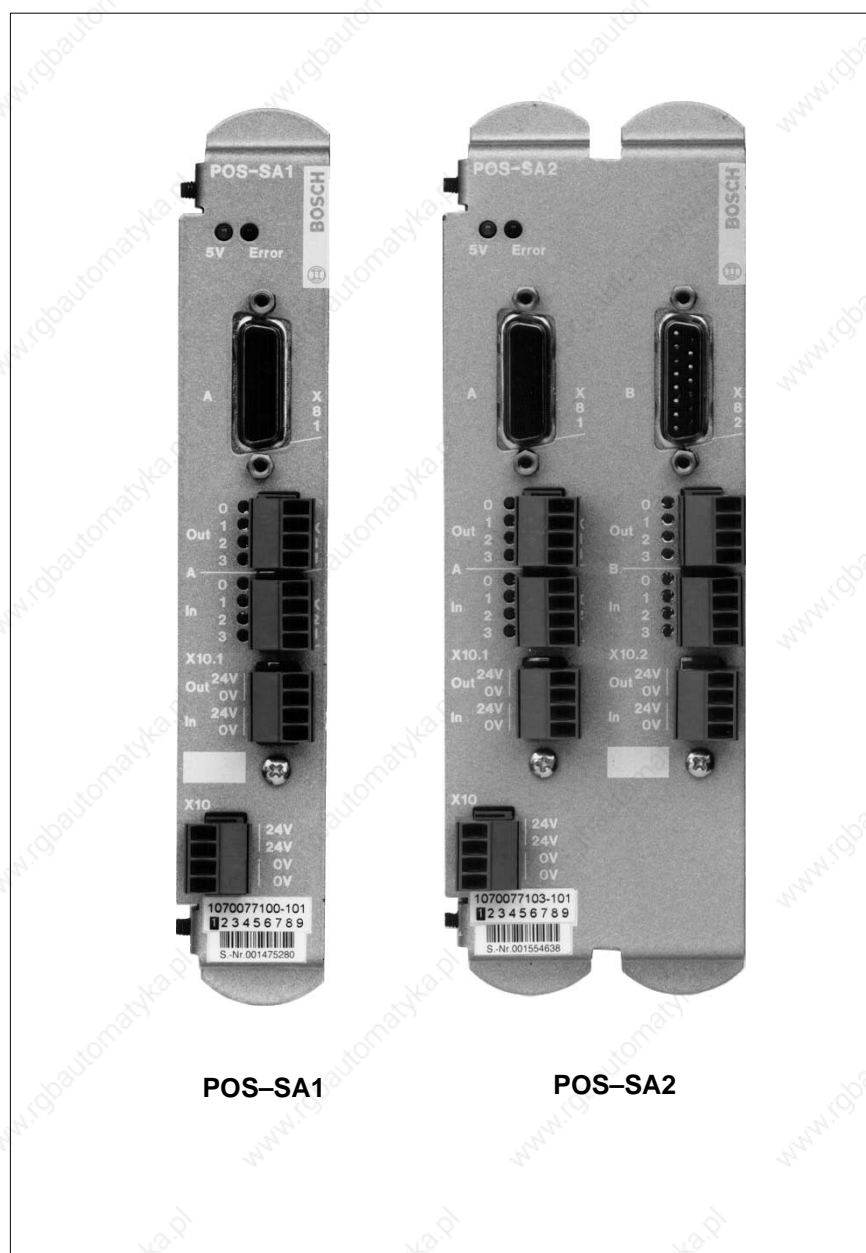

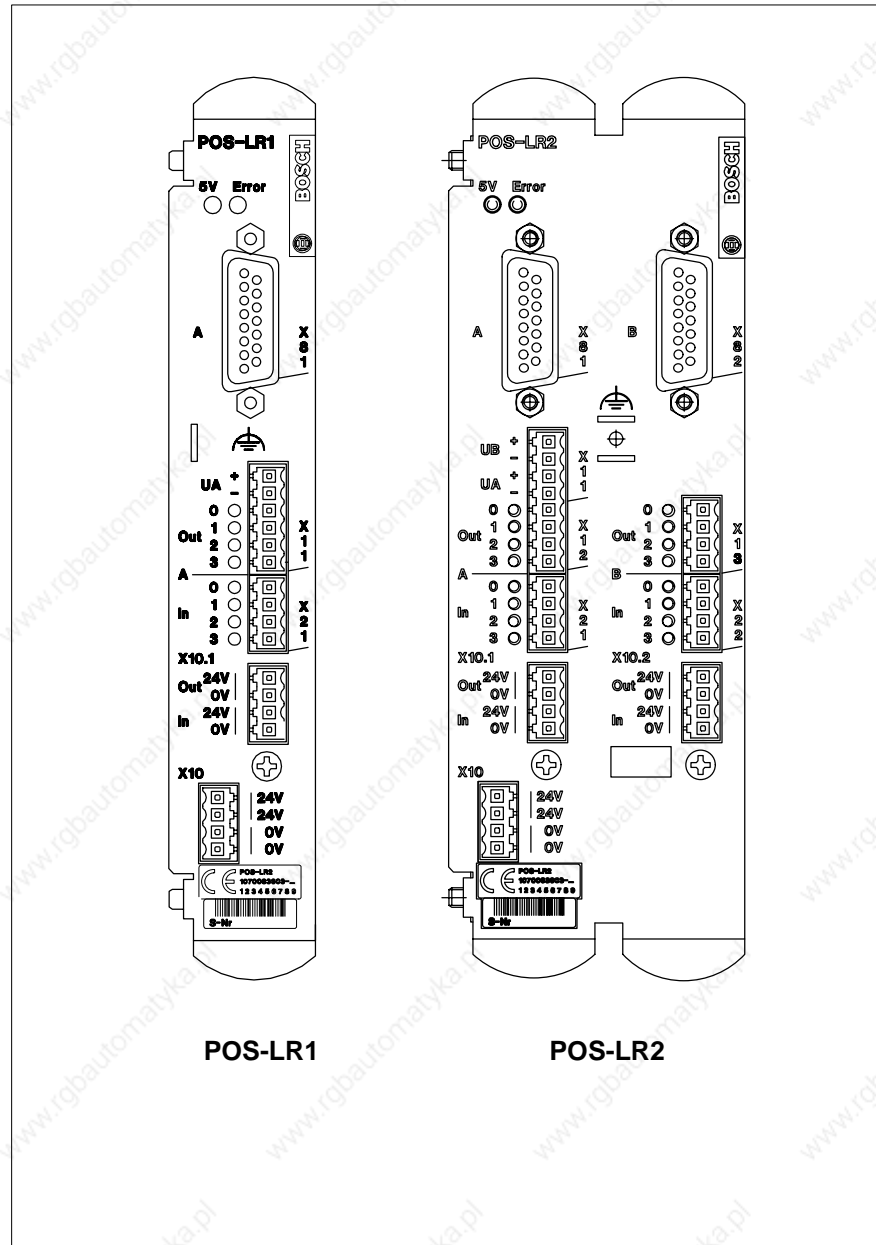

14.1.1 POS-SA1 and POS-SA2 counting / positioning modules

Module variants

Two modules are available to provide counting / positioning functions, and to handle simple positioning tasks:

- POS-SA1, w/ 1 channel
- POS-SA2, w/ 2 channels

Module tasks

The modules handle the following tasks:

- Counting

- Position sensing
- Positioning w/ interrupting axis

The modules facilitate the connection of incremental or absolute measuring / encoder systems.

POS-SA1

The POS-SA1 module features:

- 1 channel w/ selectable encoder system
- 4 digital inputs
- 4 digital outputs

POS-SA2

The POS-SA2 module features:

- 2 independent channels w/ one selectable encoder system each
- 4 digital inputs each
- 4 digital outputs each

POS-SA function module

As a prerequisite for the use of the counting / positioning modules, the POS-SA function module (Order no. 1070 077 979) is required.

14.1.2 POS-LR1 and POS-LR2 positioning modules

Module variants

For positioning tasks both comfortable and cost effective, 2 positioning modules are available:

- POS-LR1, featuring 1 channel w/ selectable encoder system
- POS-LR2, featuring two independent channels w/ one selectable encoder system each

Module tasks

The modules provide the following functions:

- Positioning 1 or 2 linear axes via positioning control and analog output
- 128 positions per channel
- Connection of incremental or absolute encoder systems

- Monitoring cable breaks via differential signals
- Hardware and software limit switches

14.2 Specifications

Specifications	POS-LR1	POS-LR2	POS-SA1	POS-SA2
Order no.	1070 078 529	1070 078 533	1070 077 100	1070 077 103
Channels	1	2	1	2
Encoder systems				
• Incremental	max. 2 ³¹ increments		max. 2 ³¹ Inkremente	
	<ul style="list-style-type: none"> • 5 V differential signals, 400 mA, max. 500 kHz • 24 V signals, 400 mA, max. 150 kHz 		<ul style="list-style-type: none"> • 5 V differential signals, max. 1 MHz • 24 V signals, max. 200 kHz 	
• Absolute	SSI parallel IF, max. 24 bits		SSI parallel IF, max. 24 bits	
Inputs EN 61131-2 Type 1	4 per channel		4 per channel	
Outputs EN 61131-2	4 per channel		4 per channel	
Analog output	1 per channel, ± 10 V			
Current draw from				
• 7.5 V, ex NT200 / RM2-DP	1 mA		10 mA	
• 24 V power supply	110 mA + external load		200 mA + external load	
Width	1 slot	2 slots	1 slot	2 slots

Module Slots

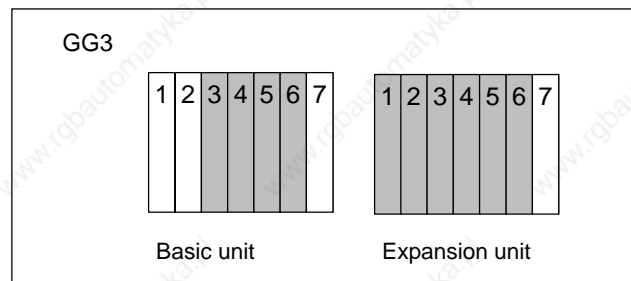

14.3 Advanced Documentation

The following manuals are available for positioning modules:

Manual	German, Order no.	English, Order no.
POS-SA1, POS-SA2	1070 072 405	1070 072 169
POS-LR1, POS-LR2	1070 072 424	1070 072 191

15 BM2-ASI Bus Master

15.1 Features and Functions



The BM2-ASI module comprises the AS-I bus master for the CL200. It thus provides the CL200 with the cost effective options of decentralized input / output connection via AS-I.

AS-I utilizes a simple 2-wire cable in a tree structure to replace the traditional, elaborate parallel wiring of each individual input / output. Connecting individual inputs / outputs via a cable harness is therefore no longer required. With the use of AS-I, an unshielded 2-wire cable is all that is needed to supply power and data to both signalling devices and actuators.

Tasks

The BM2-ASI bus master module handles the following tasks:

- Cyclical data exchange between bus station and central processing unit
- Network initialization
- Assignment of parameters to bus stations
- Data transmission diagnostics
- Addressing of substituted bus stations

AS-I profiles

The BM2-ASI module supports the following AS-I profiles:

- M0, serving inputs / outputs only
- M1, serving inputs / outputs and commands

15.2 Specifications

Specifications	BM2-ASI module
Order no.	1070 078 284
Bus stations	max. 31
Inputs / outputs	max. 124
Cycle time	5 ms, w/ 31 bus stations
Current draw, <ul style="list-style-type: none"> ● I_{Per} ● AS-I 	200 mA 100 mA
Cable length	max. 100 m
Width	1 slot

15.3 Advanced Documentation

The following manuals are available for bus master modules:

Manual	German, Order no.	English, Order no.
BM2-ASI	1070 072 442	1070 072 194

16 RM2-DP12 Module

16.1 Features and Functions

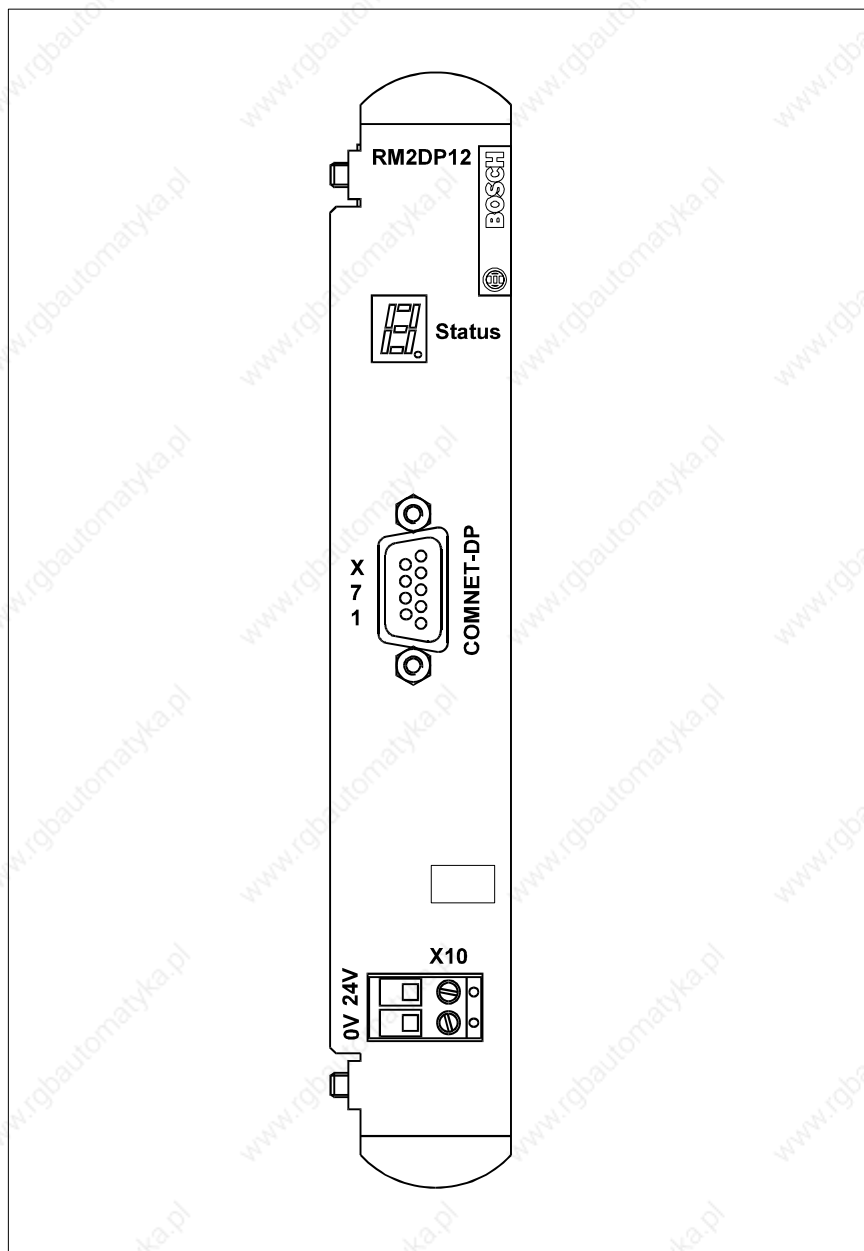

Together with components of the CL200 PLC, the RM2-DP12 module provides the option to configure a modular slave station on the PROFIBUS-DP.

The RM2-DP12 module can be inserted in a CL200 module rack. It is powered by a 24 V power supply, and also provides the 7.5 V power (max. 1.2 A) for the input and output modules.

☞ The RM2-DP must be installed in module slot 1. In a stack of several module rows, the module may be operated in the bottom row only.

The module uses single modular width.

16.2 Connecting to PROFIBUS-DP

The RM2-DP is connected to the PROFIBUS by means of a male DB-9 connector which, for security reasons, should be screwed tightly onto the female DB-9 connector of the RM2-DP12. The X71 PROFIBUS connector is located on the front panel. The pin assignment corresponds to the PROFIBUS standard.

Pin assignment, female DB-9 PROFIBUS-DP connector:

Pin	Signal	Function
1	–	not used
2	–	not used
3	B_TLG	RX / TX data P
4	RTS_SIG	Repeater control signal P (TTL signal)
5	GND_ISO	Data reference potential
6	P5V_ISO	E-pos.; 100 mA
7	–	not used
8	A_LTG	RX / TX data N
9	GND_ISO	Repeater control signal N (DGND)

From the P5V_ISO on the X71 PROFIBUS-DP connector, up to 100 mA of current can be picked off externally.

Baud Rate

The module automatically adjusts to the baud rate of the PROFIBUS-DP (9600 baud to 12 Mbaud).

Selecting bus address

A separate bus address must be assigned to each station on the PROFI-BUS-DP. The module bus address is set with the S1 DIP switch:

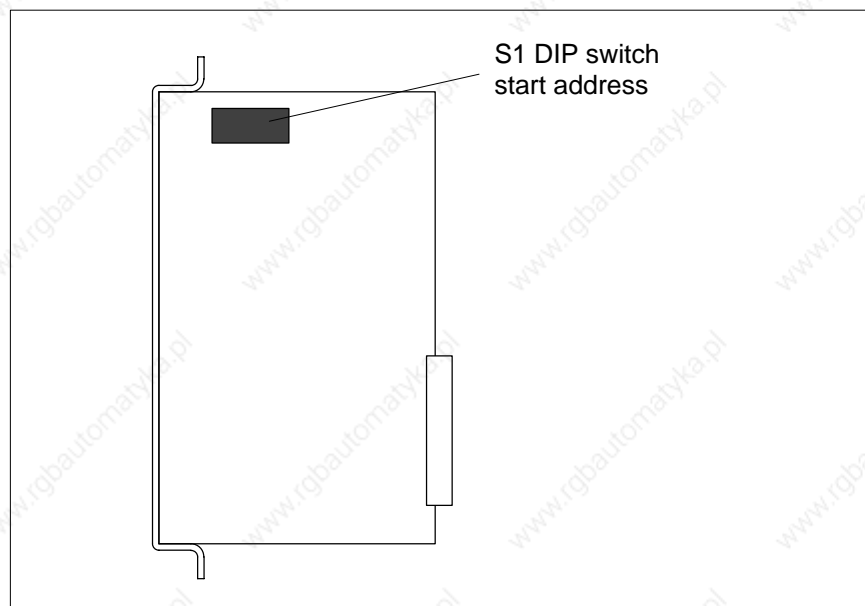

 **The selected bus address is queried only during the startup sequence, i.e., once supply power has been applied terminal X10.**

Switch	8	7	6	5	4	3	2	1
Weight	2^7	2^6	2^5	2^4	2^3	2^2	2^1	2^0
Value	128	64	32	16	8	4	2	1

Valid addresses occupy the range between 2 and 125.

16.3 Display and Control Elements

The operating status of the module are indicated on a 7-segment display. Detailed information about the meaning of individual display readings appears in the RM2-DP12 manual (Order no. 1070 072 448).

16.4 Specifications

Specifications	RM2-DP12 module
Power supply, as per EN 61131-2	24 VDC, 19.2 to 30 V
Bridging capability, intermittents on power supply module, as per EN 61131-2	Class PS2 \leq 10 ms, Repetition rate \geq 1 s
Current draw from 24 V power supply (rated current)	1.35 A
Supply voltage for peripheral modules	7.5 V
Current supplied from 7.5 V power supply for peripheral modules	1.2 A
Bus connector power supply (X71)	P5VISO / GNDISO external 100 mA max., RS-485, electrically isolated
Insulation test	500 VDC
Width	1 slot
Weight	270 g

16.5 Advanced Documentation

The following manuals are available for the RM2-DP12 module:

Manual	German, Order no.	English, Order no.
RM2-DP12	1070 072 448	1070 072 449

17 Installation

When designing and assembling a machine plant or system that will be subject to the deployment of electrical operating resources, such as control systems, etc., the regulations identified below – or similar or corresponding guidelines of the country in which the machine plant will be operating – must be observed without exception:

- DIN VDE 0100
- EN 60 204-1
- EN 50 178



DANGER

Risk of personal injury and equipment damage!

- In all circumstances, prevent hazard conditions within the system that may give rise to personal injury or equipment damage!
- The regulations applying to the configuration of Emergency-STOP devices in accordance with EN 60204-1 must be observed!
- An uncontrolled restart of machines upon return of mains power (e.g., after an Emergency-STOP) must not be possible!
- Protection in the case of direct and indirect contact must be ensured by the prescribed measures (connection to PE conductor, insulation, etc.)!

17.1 External Power Supply

All components of the CL200 are powered by a 24 V power supply.

The power supply must feature protective separation in accordance with EN 50178, section 5.2.18.1. Transformers featuring protective separation must be constructed to EN 60742.

Provided the above preconditions are met, the 24 V power supply will be considered functional low voltage with protective separation, as per EN 50 178, section 5.2.8.1. Operation may take the form of Safety Extra Low Voltage (SELV) without earthing of the reference conductor, or of Protective Extra Low Voltage (PELV), with earthed reference conductor.

A 3-phase power supply unit w/ single full-bridge rectification is adequate. The ripple content may not exceed 5 %.

All cabling of the 24 V power supply must be routed / installed as follows:

- Separate from cables carrying higher voltages, OR
- featuring special insulation, with the minimum insulation rating suitable for the highest of all occurring voltages, refer to EN 60 204-1: 1997, section 14.1.3.

 **All peripheral devices (e.g., digital sensors / actuators) connected to the interfaces of the CL200 must also meet the criteria of protective separation from electrical circuits.**

17.2 24 V Power Supply

To supply the 24 V power for the NT200 power supply module, external actuators and peripheral modules, external 24 V external power supply units are available. For detailed information, refer to the price list (available w/ order no. 1070 072 061).

17.2.1 Hardware Configuration w/o Electrical Isolation

The simplest means of connection comprises the hardware configuration without electrical isolation between internal logic circuits and peripheral power supply.

In this case, a power supply will be adequate to power the CL200. However, to meet the requirements of overvoltage category II, the use of an autotransformer is not permitted.

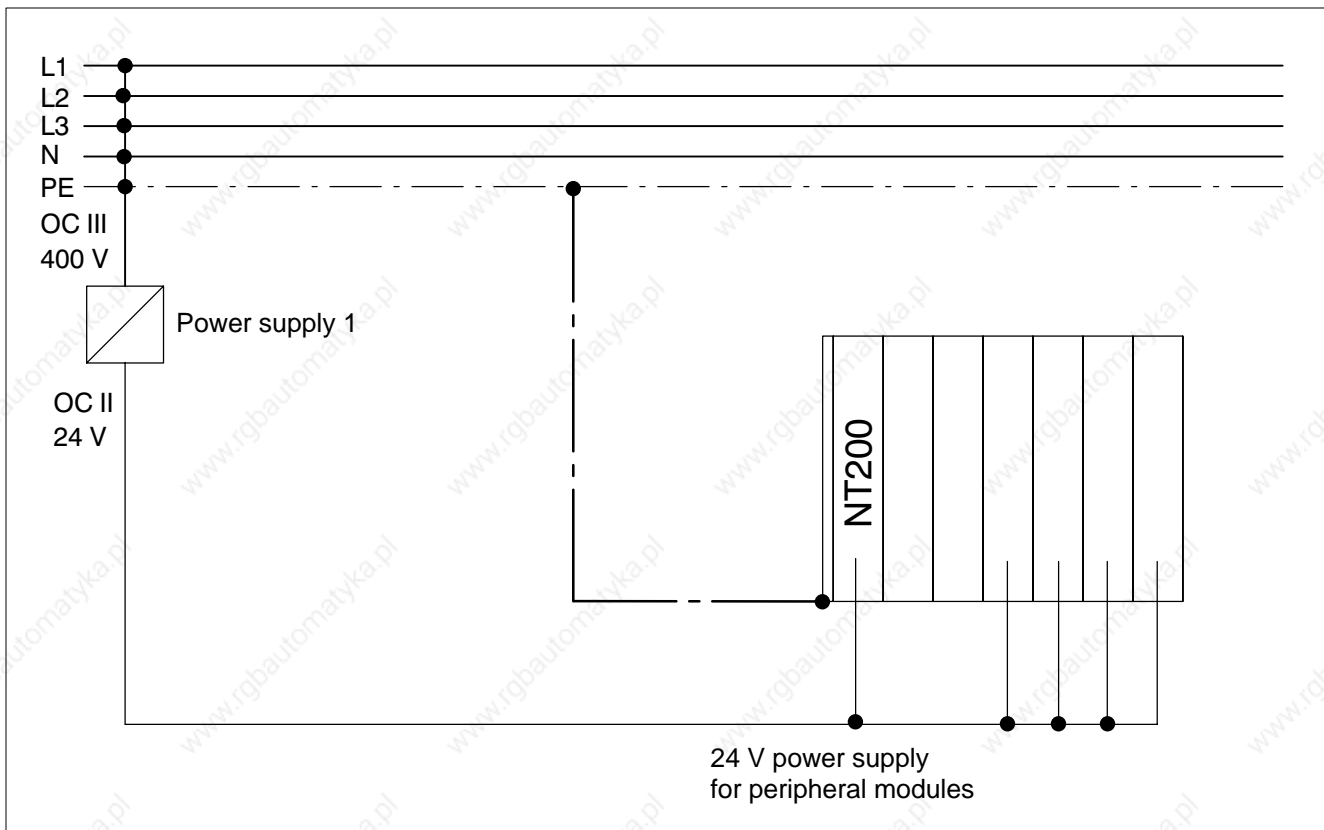

17.2.2 Hardware Configuration w/ Electrical Isolation

The provisions of DIN EN 60204-1 requires electrical isolation to exist between the logic circuits of the central processing unit and the I/O interfaces connecting the peripheral modules. As the NT200 power supply module is non-floating, the required electrical isolation can be achieved only by providing a separate power supply unit for the NT200 on the one hand, and the peripherals on the other.

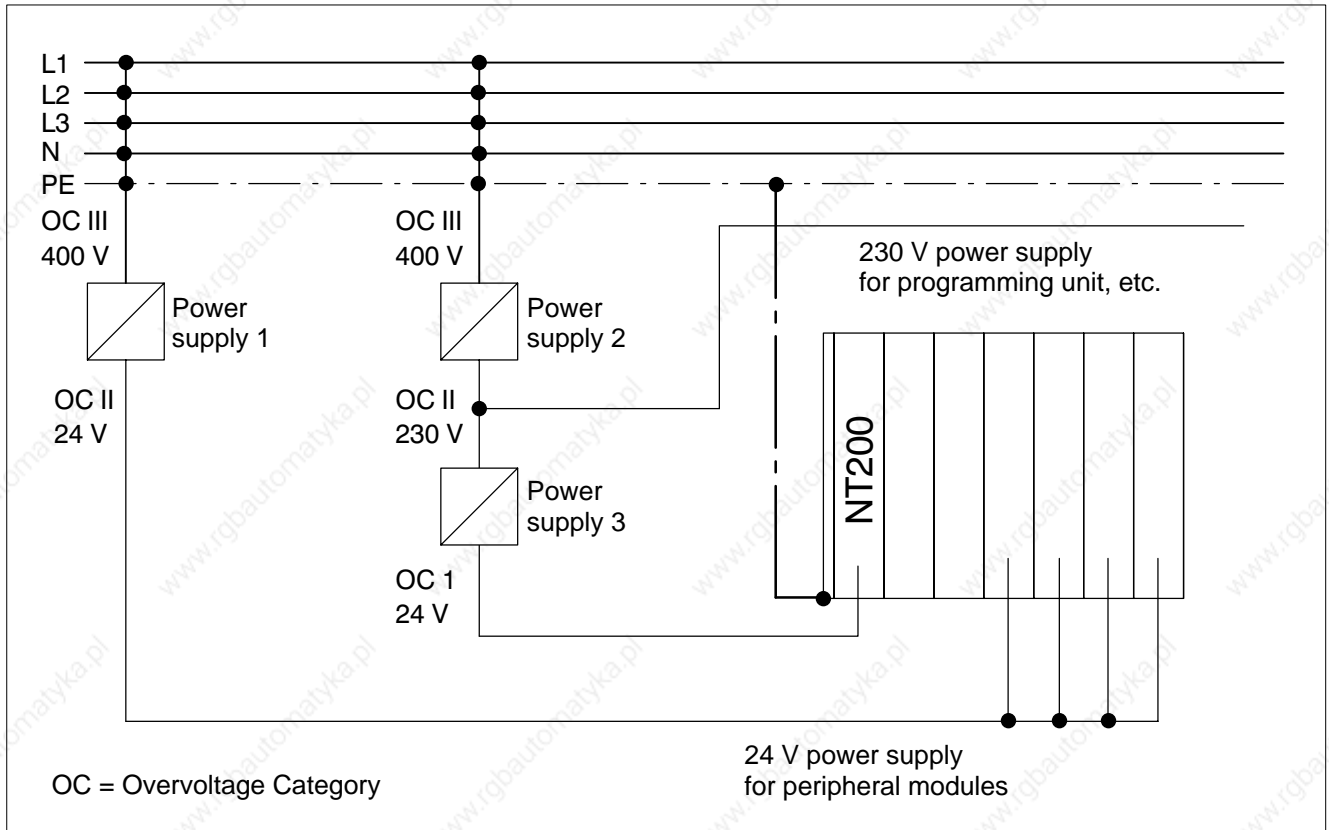

The power supplies 2 and 3, which provide operating power to the NT200, may also be substituted by a single 400 V / 24 V combination power supply. If this is the case, overvoltage category (OC) II will apply to the logic circuits.

It is often desirable to isolate groups of input and output signals from each other. To accomplish this, several power supplies or power supplies featuring several separate output voltages may be used to replace power supply 1 (diagram).

17.2.3 Reference Conductor Connected to Protective Earth

If the reference conductor (N, 0 V) is interconnected with PE conductor network, this connection must centrally be located for easy accessibility (e.g., on the external power supply or isolating transformer). The connection must facilitate easy interruption, e.g., for the purpose of measuring earth leakage currents. As a result, the power supply circuit becomes a PELV circuit (see also section 17.1).

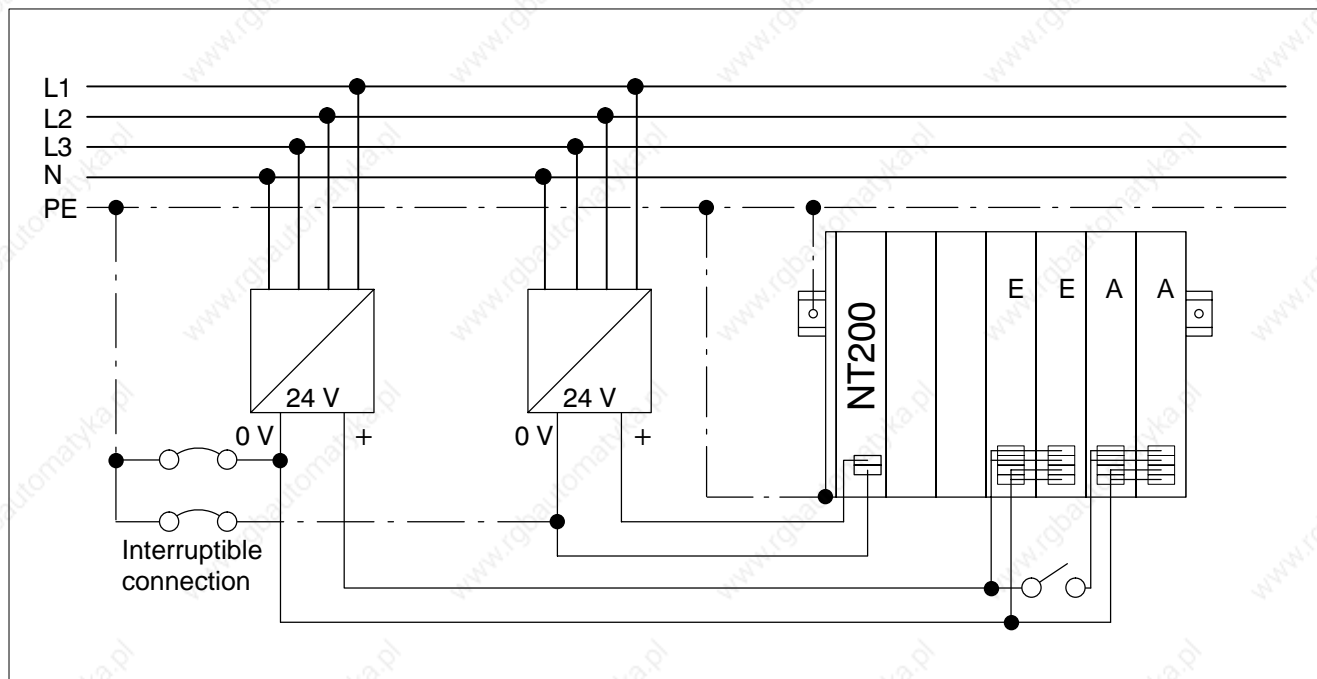

17.2.4 Reference Conductor Not Connected to PE Conductor

If the reference conductor (N, 0 V) is not interconnected with the PE conductor network, the introduction of a suitable earth leakage monitor for the detection of ground faults will be required. This provides protection against inadvertent Power-On in the case of insulation faults. As a result, the power supply circuit becomes a SELV circuit (see also section 17.1). In this context it must be considered that the earth-leakage protection may also be rendered ineffective by virtue of connecting additional electrical equipment.

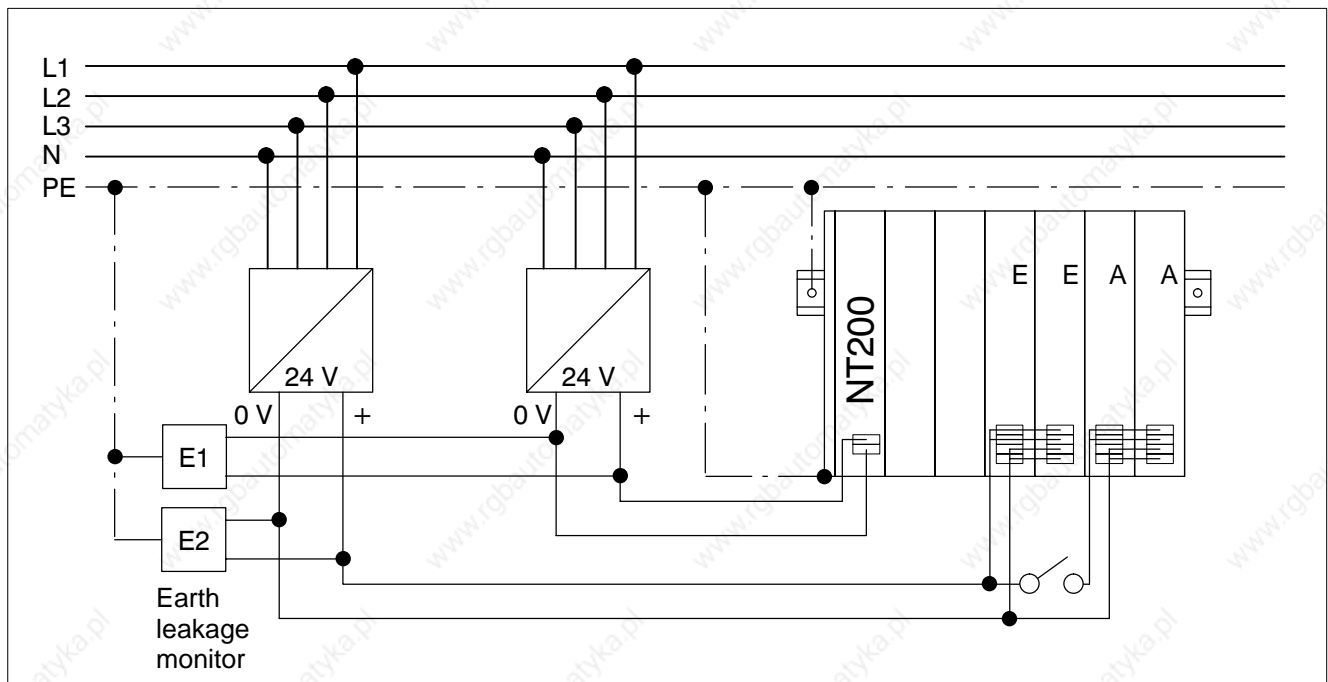

17.2.5 Programming Unit and Earthing

In the majority of cases, programming units inherently feature a connection between (equipment) ground and protective earth. This connection gives rise to problems in situations where the power supply of the CL200 is equipped with an earth-leakage monitor and the programming unit is connected to the central processing unit.

Due to the non-isolated operation of the NT200 power supply module, the earth fault in the programming unit continues via the central processing unit and the NT200 power supply module to trigger the earth-leakage monitor. In this case, the monitoring device should not cut power to the system automatically but simply provide an indication or display of the earth leakage. The maintenance personnel should be informed of this operating characteristic.

17.2.6 Capacitive Load in Power Supply Network

All CL200 modules contain capacitive interference suppression measures installed between the power supply lines and protective earth. This fact must be taken into account when employing an earth-leakage monitoring device.

Module	24 V → PE	0 V → PE
NT200	5 nF	100 nF
ZE200	–	10 nF
ZE200A	–	10 nF
ZE200M	–	25 nF
ZE200AM	–	25 nF
ZE201	–	10 nF
ZE200-DP / ZE200A-DP	–	20 nF
E24V– (16-way)	5 nF	10 nF
E24V– (32-way)	5 nF	10 nF
E16/A8	5 nF	15 nF
E16/A16	5 nF	15 nF
A24V–/0.5A (16-way)	15 nF	15 nF
A24V–/0.5A (32-way)	30 nF	30 nF
A24V–/2A	10 nF	15 nF
AR/2A	15 nF	5 nF
E ana	25 nF	25 nF
E20 ana	25 nF	25 nF
A ana	5 nF	5 nF
A20 ana	25 nF	25 nF
A10 ana (4)	25 nF	25 nF
A10 ana (8)	25 nF	25 nF
R200	–	–
R200P	–	–
COM2–E	–	–
POS–SA1	15 nF	15 nF
POS–SA2	25 nF	25 nF
POS–LR1	15 nF	15 nF
POS–LR2	25 nF	25 nF
BM–ASI	–	–
DP–EA4	–	–
AG/S	–	–
RM2–DP12	4.7 nF	4.7 nF

17.2.7 Dimensioning Power Cables

Maximum current levels must be considered when determining the dimensions of power cables (refer to VDE 0100-523). The voltage applied directly to the device must be between 20.4 and 28.8 V.

The voltage must be maintained also in the event of the following:

- Mains voltage fluctuations, e.g., caused by variations of power grid loads.
- The variety of possible load statuses, such as short-circuit, normal load, Lamp load or idle, for example.

The maximum cable cross-section for the power supply of the CL200 is 1.5 mm².

Voltage dips

To maintain uninterrupted operation, the CL200 is capable of bridging voltage dips lasting up to 10 ms.

No compensation is however possible in the case of voltage dips in the power supply of the outputs. This may cause contactors and other actuators to drop off in the case of voltage drops.

The occurrence of input data falsified through voltage drops is prevented via filters on the input modules. The input response time is 3 ms. If longer power interruptions occur, suitable measures must be introduced.

17.2.8 Master Switch

A master switch conforming to VDE 0100 must be provided for the CL200, as well as for sensors and actuators.

17.2.9 Fuses

The purpose of fuses and circuit breakers is to protect the cables in a power network. The power supply cables of the CL200 must be protected. When providing fuse protection, the power supplies for sensors and actuators should be protected by separate fuses. In the event that power cables are shorter than 3 metres and are installed in a manner that is short-circuit proof, fuse protection may be waived.

A variety of criteria must be considered when selecting fuses. Paramount among them is the rated current of the circuit to be protected (refer to VDE 0100-430). The rated current also determines cable cross-section (refer to VDE 0100-523).

Additional criteria for the selection of protective elements are listed below.

- Rated voltage
- Temperature
- Internal resistance of fuses
- Inrush currents
- Cable lengths

- External impedance / source impedance of network
- Possible fault location
- Vibration

For further information, refer to the following (German-language) manual:

Handbuch Nr. 32
VDE Schriftenreihe
Bemessung und Schutz von Leitungen und Kabeln nach DIN 57 100,
VDE 0100-430 und -523.

Appropriate information is also available from many manufacturers of fuses and circuit breakers.

17.2.10 Earthing

Functional earthing

The GG3 and GG3-K module racks of the CL200 must be mounted on a metallic, earthed support, such as the rear panel of a control cabinet, for example.

Functional earthing is required to provide optimum interference protection. The functional earthing connection must comprise the shortest possible cable or consist of a grounding strap, the latter being the preferred solution.

Guidance value: Length: max. 1 m
 Cross-section: 6 mm²

Equipotential bonding

Equipotential bonding must be established between system components and power supply, as per DIN VDE 0100, Part 540.

Protective Earth (PE)

All components of the CL200 must be connected to the PE protective earthing system at the specially marked connections.

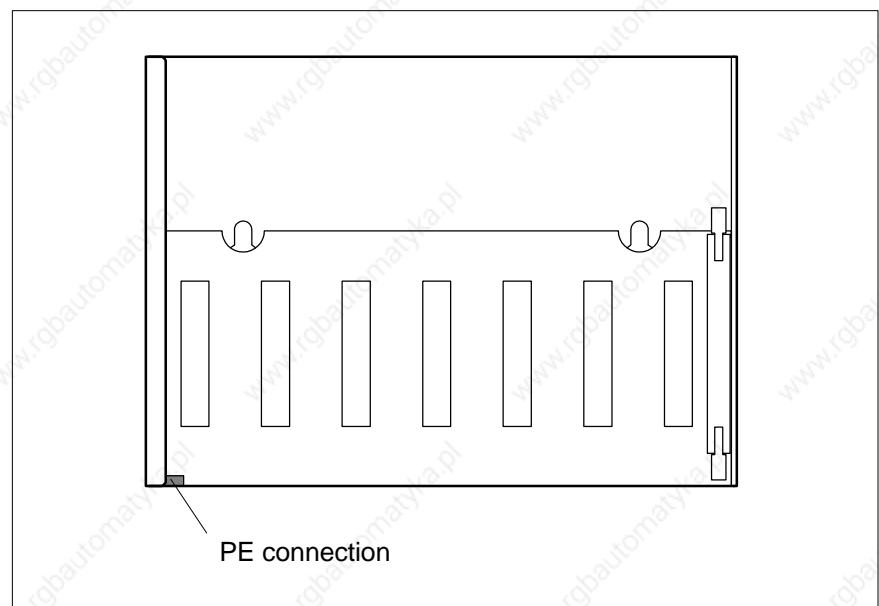

The protective earthing conductor is connected by means of an M4x6 oval head screw with lock washer and flat washer.

17.3 Electromagnetic Compatibility (EMC)

Electromagnetic compatibility (EMC) is defined as the capability of an electrical device to function satisfactorily within its electromagnetic environment without unduly interfering with said environment in which other devices may also be accommodated (EN 61 000-4-1).

17.3.1 Interference

To the user, possible sources of interference may include:

- Locally generated interferences, e.g., by frequency converters, inductive loads, etc.
- Extraneous interferences, e.g., electrical discharges in the atmosphere (lightning), mains voltage fluctuations, etc.

The cited interference sources influence the affected electrical device, the so-called interference sink, in a variety of ways. The major means of interference transfer are the following:

- Radiated interference injection
- Line transient interference of mains supply
- Electrostatic discharges

Line transient interferences may mutate into radiated interferences, and vice versa. On a live power cable, for example, the line transient interference generates a field which in turn also generates a line transient interference on a cable that is routed in parallel.

17.3.2 Signal-to-Noise Ratio

The signal-to-noise ratio is defined as the capability of a device or component to tolerate interferences up to a specific level without being restricted in their operation. For example, electronic devices such as controllers have a significantly lower signal-to-noise ratio (interference tolerance) than other electrical devices such as contactors.

17.3.3 EMC Directive and CE Label

Taken as a whole, a process plant must meet certain minimum requirements with regard to interference resistance. Compliance with the relevant stipulations is contingent upon the process plant engineering company and/or the vendor of the machine system. Such are the facts as prescribed by the EMC Statute that is based on the EMC Directive formulated by the Council of the European Communities.

The minimum requirements for compliance with the EMC Statute are defined in the form of standards applying to product families. In cases where such standards do not exist, generic standards are applied. Conformity with the corresponding regulations is indicated by affixing the CE Label.

The CE Label signals conformity with all relevant guidelines issued by the Council of the European Communities. However, it shall not be taken as a seal of quality, nor does it promise certain properties. Instead, its sole purpose is to address the governing authorities.

Depending on the product and area of application, several guidelines or Directives may be of relevance. In addition, the manufacturer is required to produce an appropriate Declaration of Conformity which, in the case of an inspection by the governing authority, must be made accessible to its representatives.

In standard practice, conformity is most commonly proven with the use of standard tests described in the so-called generic standards, e.g., in EN 61000-4-X = VDE 0847-4-X. However, to ensure interference resistance also in the field, the user himself must adhere to the installation prerequisites and instructions supplied by the manufacturer.

More often than not, when planning and constructing a process plant and/or machine system, the EMC Directive is augmented by the Low-voltage Directive, EU Declaration of Conformity, and quite possibly a number of guidelines referring to specific types of system installations.

17.3.4 EMC Characteristics of the CL200

As a standalone unit, the CL200 already meets the EMC requirements arising from the governing standards.

Compliance with these standards was tested on specific system configurations. However, this fact shall not be construed to mean that such testing serves to confirm the existence of the required electromagnetic compatibility of the system for any given configuration. The responsibility for the overall system is borne only by the process plant engineering company.

Sufficient electromagnetic compatibility may be achieved only on the basis of meticulous adherence to installation guidelines. Only when this prerequisite has been met, it may be safe to assume that a system composed of individual devices bearing the CE Label also complies, as an entity, with the protection objectives embodied in the Directive issued by the Council of the European Communities.

As regards the application of the Directive, a largely comprehensive overview was provided in the “Guidelines on the application of Council Directive 89/336/EEC of May 1989 on the approximation of the laws of the Member States relating to electromagnetic compatibility”, which was, in its release dated 23 May 1997, published by the European Commission.

Radiant emittances, radio interference

The CL200 meets the requirements of the generic EN 50081-2 standard which defines the limit values for interference emissions. This standard applies exclusively to application in industrial areas. In contrast to residential areas, application in industrial areas is characterized by the following stipulations:

- Connection to the public low-voltage mains network is not permitted.
- Enterprise-owned high or medium voltage transformer is available.
- Operation occurs in an industrial environment or in the vicinity of industrial power grids.

The term “industrial area” bears no relevance to the separation of industrial and residential zoning on the basis of the planning and building laws and regulations of some countries.

The limit values for industrial applications are higher than those governing application in a residential area. For this reason, in anticipation of the deployment of this equipment in a residential area, the user is required to introduce certain additional measures:

- Installation of the controller system in a control cabinet and/or a housing providing a high degree of screening attenuation.
- To meet the requirement of reduced emission values, all cables exiting the screened area (e.g., control cabinet) must be provided with filter and screening measures.

For system application within a personal residence, in business areas, on retail premises or in a small-industry setting, the user will be required to obtain a single operating license issued by the appropriate national authority or approval body.

Protection against electrostatic discharges

All modules belonging to the CL200 controller system contain components that may be destroyed as a result of electrostatic discharges (ESD). It should be noted that a defect inflicted on a module must not necessarily be recognizable immediately. Instead, it may manifest itself through occasional or delayed unit failures.

For this reason, the standard procedures for handling electronic components and assemblies must be strictly observed. It is specifically prohibited to remove or connect plug connectors on a live unit. Before touching or grasping a module, the respective person must ensure that he or she is electrostatically discharged.

17.3.5 Installation Procedures Ensuring Interference Resistance

Without exception, priority shall always be given to the prevention or remedy or elimination of interference at the source. To this end, the following items must be observed:

Earthing arrangements

To eliminate interference potentials acting between the device and reference earth, the housing must be connected to ground via a low-impedance connection. Particularly in the case of pulsed interference with rise times in the nanosecond range, the considerable inductive potential of simple cables poses a significant barrier to the discharge of interference. Because earthing straps exhibit significantly better high-frequency properties, they must always be given preference.

Screening

A major source of interference is produced by magnetic or electrical transfer. The prevention of transfer may be achieved through the introduction of adequate screening and spatial separation. In consequence, this has become the basis for the requirement to install interference-prone components, such as power supply and motor cables, contactors and frequency converters, etc., separately or screened from components with a lower interference signal-to-noise ratio, such as signal lines and electronic control units.

The consistent spatial separation between potential sources and sinks of interference as early as in the planning phase is the most cost-effective measure toward maximizing the interference resistance of any system.

Preference shall be given to transformers featuring shielding windings because these provide very effective interference attenuation in the higher voltage range.

Twisted-pair wiring

Mainly in the case of data lines but also with power supply cables, engineers resort to the use of twisted-pair wiring. The tightly entwined conductors prevents the occurrence of interference due to transfer between the conductors.

As an important requirement the twisted-pair cable must consist of forward and return line, which means that the flowing currents add up to zero. This is the case with many data transmission methods and also quite common with power supplies. Standard bus cables are supplied as twisted-pair versions.

Parallel routing of data lines and interference-prone power cables

The parallel installation of data lines or input/output signal cables and interference-prone cables (motor cables or cables connecting contactors featuring poor interference suppression) must be avoided. The smaller the distance of cables routes in parallel, the larger the transferred interference.

Power cables and data lines routed in cable channels and control cabinets must be placed at the largest possible distance of each other. The minimum distance is 10 cm, and the preferred cable routing is in separate, screened compartments. Intersections between data lines and power cables shall use a 90-degree angle.

Interference suppression of inductive loads

As a rule, most controller outputs use built-in clamping diodes to reduce inductive cut-off switching peaks to a benign level. This also applies to the outputs of the CL200 system.

However, the occurrence of a cable break, the removal of a plug connector feeding an inductive load (e.g., solenoid valves and contactors, etc.), or the intended shut-off via mechanical contact causes very high interference voltage peaks. These can spread throughout the system via electrical, inductive or capacitive transfer. To achieve the required attenuation, the inductive load must be connected via appropriate interference suppression elements, such as freewheeling diodes, varistors and resistance-capacitance circuits.

Due to their universal applicability, the use of bidirectional suppressor diodes is recommended. These consist either of two polarity-reversed, series-connected suppressor diodes, or of a polarized suppressor diode with bridge rectifier. Premanufactured modules of these types are readily available.

Similarly well suited to the described purpose are varistor modules provided by contactor manufacturers to match their contactor models, for example.

Filters

In normal circumstances, the interference resistance of CL200 modules guarantees their proper functioning even in environments exhibiting relatively high interference levels. To further improve EMC characteristics, it may become necessary to introduce additional filtering measures. All such measures must be investigated on a case-by-case basis. Suitable filters may be selected from a large variety of products provided by industry suppliers.

A Appendix

A.1 Index

Numbers

2-wire proximity switch, 6-3, 8-4
 20 mA interface, 5-20
 24 V power supply, 4-1, 17-1
 32-bit counters, 5-13

A

A ana, 13-2
 A10 ana, 13-2
 A20 ana, 13-2
 addressing, 6-4, 7-3, 8-3
 AG/S, 3-6, 3-10
 AG/S expansion module, 10-1
 analog input, 5-2, 5-15, 12-2
 analog input modules, 12-1
 analog output, 5-2, 5-17, 13-1
 analog output modules, 13-1
 applicable standards, 2-5
 AS-I bus master, 15-1
 assembly, 3-2
 atmospheric pressure, 2-6

B

basic unit, 2-7, 3-5, 7-2, 9-2
 battery failure, 4-5
 battery load test, 4-3
 battery replacement, 4-6
 Battery Reset, 4-6
 Battery Reset button, 4-3
 baud rate, 5-19, 5-21
 BM2-ASI, 15-1
 bus coupler, 3-6, 3-9

C

cable break, 5-16
 cable length, 5-12, 5-16, 5-18, 5-21, 7-11, 8-9
 CE Label, 17-11
 central processing module, 4-5
 central processing unit, 2-2, 3-5, 4-4, 5-2
 chemical resistance, 2-6
 CL200, 2-5
 clear space, 3-3, 3-11, 3-12, 3-13
 COM2-E, 11-4
 command processing time, 5-29
 communication modules, 11-2
 connecting cable

- for X31 interface, 5-21
- for X32 interface, 5-23
- for X73 interface, 5-25

connection

A 24 V-, 7-4
 AR/2A, 7-7
 basic prerequisites, 17-1
 DP-EA4, 9-3
 E 24 V-, 6-3
 E16/A, inputs, 8-4
 E16/A, outputs, 8-6

control elements

NT200, 4-3
 ZE, 5-5

control line, 5-20

Corrosion, 2-6

counters, 5-3, 5-29

counting and positioning modules

POS-SA1, 14-2
 POS-SA2, 14-2

current draw, 2-5, 4-7, 16-4

current rated output, 5-17

cycle time, 5-29

D

data bit, 5-20

data modules, 5-2

dimensions, 2-7

display elements

NT200, 4-3
 ZE, 5-5

Documentation, 1-7

DP-EA4, 9-1

drilling template, 3-9

drilling template, GG3-K, GG3, 3-3

Dual inline configuration, 3-6

dummy cover, 3-5

E

E 24 V-, 6-5

E ana, 12-2

E20 ana, 12-3

earthing, 17-5, 17-9, 17-13

earthing wrist strap, 1-6

electromagnetic compatibility, 17-10

EMC characteristics, 17-11

EMC Directive, 17-11

filtering measures, 17-14

S/N ratio, 17-10

electrostatic discharges, 17-12

Electrostatically sensitive devices, 1-6

EMC Directive, 1-1

Emergency-STOP-devices, 1-5

ensuring interference resistance, 17-13

equipotential bonding, 17–9
 ESD (electrostatically sensitive devices), 1–6
 ESD protection, 1–6
 ESD work stations, 1–6
 expansion module AG/S, 10–1
 expansion unit, 2–2, 2–7, 3–6, 3–8
 structure, 3–8

F

firmware, 5–6
 fixation, 5–2
 Flash-EPROM memory, 5–2, 5–27
 forward counter, 5–13
 functional earthing, 17–9
 fuse, 7–10, 7–12, 17–7
 – F1, 7–3
 – F2, 7–3
 fuse, replacing, 7–2

G

GG3, 3–1, 3–5, 3–6
 GG3-K, 3–1, 3–5, 3–6

H

hardware modules, with UL certification, 2–3
 high-speed counters, 5–3, 5–13
 humidity rating, 2–6

I

I/O image, 5–29
 in-line module arrangement, 3–6
 input, 5–29
 input characteristic, 8–5
 input module, – E 24 V–, 6–1
 input power intermittents, 2–5
 input/output module, 8–1
 Installation, horizontal, multi-row, 3–10
 installation, 2–6, 3–2
 – screw mounted surface installation, drilling template
 for GG3-K, GG3, 3–3
 – with locking foot, 3–4
 inline, horizontal, 3–8
 instruction, 5–2
 insulation test voltage, 2–6
 interface connections, central processing unit, 5–10
 interfaces, 5–21
 – X31, 5–19
 central processing unit, 5–10
 interference emission, 2–5
 interference resistance, 2–5
 interference suppression, 17–14
 interpretation, 5–11
 interrupt input, 5–12, 5–29
 interrupt response time, 5–29
 interrupt signal, 5–2

L

line status, 5–20
 load
 – inductive, 7–10, 8–8
 – resistive, 7–10, 8–8

load, capacitive, 17–6
 locking foot, 3–3
 Low Battery, 4–3
 Low Battery warning, 4–5
 Low Battery warning signal, 4–3
 Low-Voltage Directive, 1–1

M

master switch, 17–7
 Measuring or testing procedures, 1–5
 memory, 5–30
 memory backup battery, 4–3, 4–5
 MemoryCard, 2–5, 5–3, 5–9, 5–29, 5–30
 mixed operation, 5–2
 modul slots, – E 24 V–, 6–2
 module rack, 3–1
 module slot, 2–7
 – A 24 V– 0,5 A, 7–2
 – E 24 V–, 8–2
 – NT200, 4–2
 – ZE200, 5–4
 – ZE200A, 5–4
 – ZE200AM, 5–4
 – ZE200M, 5–4
 multiple inline configuration, 3–6

N

NT200, 2–5, 3–5, 4–1
 See also power supply module

O

operating mode, 5–27
 operating status, 5–6, 5–7
 operating temperature range, 2–6
 ordering information
 – A 24 V– / 0.5 A, 7–12
 – basic unit, 3–6
 – DP-EA4, 9–5
 – E 24 V–, 6–5
 – E16/A16– 0.5 A, 8–9
 – E16/A8– 0.5 A, 8–9
 – expansion unit, 3–7
 – GG3, 3–1
 – NT200, 4–8
 – ZE200, 5–30
 – ZE200A, 5–30
 – ZE200AM, 5–30
 – ZE200M, 5–30
 output, 5–29
 output module, – A 24 V– 0.5 A, 7–1

P

parallel routing of cables, 17–13
 parity, 5–20
 PCMCIA, 5–30
 – interface, 5–9
 PE conductor, 17–4
 performance range, 2–2
 periphery module, 4–4
 PG programming unit, 5–19
 – and earthing, 17–5

PLC

- program, 5–27
- program memory, 5–2
- program documentation, 2–4

pollution level, 2–6

POS-LR1, 14–3

POS-LR2, 14–3

POS-SA1, 14–2

POS-SA2, 14–2

potential differential, 5–20

power supply, 2–5, 4–1

- dimensioning, 17–7

power supply module, 4–1, 17–1

program memory, 5–29

programme structure, 2–4

programming, 2–4

protection category, 2–6

Protective Earth , 17–9

Q

Qualified personnel, 1–2

R

R200, 11–2

R200P, 11–3

radiant emittances, 17–12

radio interference, 17–12

radio interference suppression, 2–5

RAM, 5–2, 5–27

reference conductor, 17–4

register, 5–29

reverse counter, 5–13

reverse polarity protection, 7–2

RM2-DP12, 16–1

S

S1 DIP switch, 6–4, 7–3, 8–3, 16–3

safety class, 2–6

Safety instructions, 1–4

Safety markings, 1–3

screening, 17–13

shock and vibration resistance, 2–6

signal level, 5–20

signal-to-noise ratio, 17–10

Spare parts, 1–5

Specifications, – CL200, 2–5

specifications

- analog input, 5–16
- analog output, 5–18
- DP-EA4, 9–5
- E 24 V–, 6–5
- high-speed counters, 5–13, 5–14
- interrupt input, 5–12
- NT200, 4–7, 16–4
- ZE200, 5–29
- ZE200-DP, 5–29
- ZE200A, 5–29
- ZE200AM, 5–29
- ZE200M, 5–29
- ZE201, 5–29

Standard operation, 1–1

Start address, 6–4

start address, 7–3, 8–3

Stop, 4–6

stop bit, 5–20

storage temperature range, 2–6

support rail, 3–3, 3–9, 5–10

system area, 5–16

system clock, 5–3, 5–29

system monitoring, 5–2

T

TFTP protocol, 11–5

total current, 7–5, 8–6

Trademarks, 1–7

transmission format, 5–20

transportability, 2–6

twisted-pair wiring, 17–13

U

UL certification, 2–3

V

V.24 interface, 5–20

voltage dips, 17–7

voltage rated output, 5–17

W

weight, 2–7

X

X31, 5–19, 5–30

X71, 5–11, 5–30

X72, 5–30

Z

ZE200, 2–2, 5–2

ZE200-ADP, 2–2

ZE200-DP, 5–2

ZE200A, 2–2, 5–2, 5–15

ZE200A-DP, 5–15

ZE200A-DP, 5–2

ZE200AM, 2–2, 5–2, 5–9, 5–15

ZE200M, 2–2, 5–2, 5–9

ZE201, 5–2

Notes:

Bosch Automation Technology

Australia

Robert Bosch (Australia) Pty. Ltd.
Head Office
Cnr. Centre - McNaughton Roads
P.O. Box 66
AUS-3168 Clayton, Victoria
Fax (03) 95 41 77 03

Great Britain

Robert Bosch Limited
Automation Technology Division
Meridian South
Meridian Business Park
GB-Braunstone Leicester LE3 2WY
Fax (01 16) 289 2878

Canada

Robert Bosch Corporation
Automation Technology Division
6811 Century Avenue
CAN-Mississauga, Ontario L5N 1R1
Fax (905) 5 42-42 81

USA

Robert Bosch Corporation
Automation Technology Division
Fluid Power Products
7505 Durand Avenue
USA-Racine, Wisconsin 53406
Fax (414) 5 54-81 03

Robert Bosch Corporation
Automation Technology Division
Factory Automation Products
816 East Third Street
USA-Buchanan, MI 49107
Fax (616) 6 95-53 63

Robert Bosch Corporation
Automation Technology Division
Industrial Electronic Products
40 Darling Drive
USA-Avon, CT 0 60 01-42 17
Fax (860) 4 09-70 80

We reserve the right to make technical alterations

Your concessionary

BOSCH



Robert Bosch GmbH
Geschäftsbereich
Automationstechnik
Antriebs- und Steuerungstechnik
Postfach 11 62
D-64701 Erbach
Fax +49 (0) 60 62 78-4 28