

MANUFACTURER DATA SHEET

Motor Drive

Manufacturer:

KEB

Model Number:

COMBIVERT

See www.geomartin.com for additional PDF datasheets

Martin Part Number: VendorPartNumber:

E-065165-00	KEBCO# 07.F5.C1B-LBOA, 1HP AC 460V
E-065165-01	KEBCO# 10.F5.C1B-LA0A, 3HP AC 460V
E-065165-02	KEBCO# 12.F5.C1D-L5OA, 5HP AC 460V

www.rgbautomatyka.pl

This page is intentionally left blank

COMBIVERT



D	BETRIEBSANLEITUNG	Steuerteil ab V2.3
F	MANUEL D'INSTRUCTIONS	Carte de commande à p. de V2.3
GB	INSTRUCTION MANUAL	Control Circuit from V2.3
I	MANUALE D'ISTRUZIONE	Circuito di controllo dalla V2.3
E	MANUAL DE INSTRUCCIONES	Circuito de control de V2.3
RU	Руководство по эксплуатации	Карта управления от V2.3



Erst Betriebsanleitung Teil 1 lesen !
Lisez d'abord le manuel d'instructions partie 1 !
Read Instruction manual part 1 first !
Prima leggere il manuale di controllo parte 1 !
Leer manual de instrucciones parte 1 !
Сначала прочти инструкцию часть 1 !



D

Seite
D - 3 D - 38

Diese Betriebsanleitung beschreibt die Steuerungen der KEB COMBIVERT F5 - Serie. Sie ist nur gültig in Verbindung mit der Betriebsanleitung Teil 1 und Teil 2. Alle Anleitungen müssen jedem Anwender zugänglich gemacht werden. Vor jeglichen Arbeiten muß sich der Anwender mit dem Gerät vertraut machen. Darunter fällt insbesondere die Kenntnis und Beachtung der **Sicherheits- und Warnhinweise aus Teil 1**. Die in dieser Betriebsanleitung verwendeten Piktogramme entsprechen folgender Bedeutung:



**Gefahr
Warnung
Vorsicht**



**Achtung,
unbedingt
beachten**



**Information
Hilfe
Tip**

F

Page
F - 3 F - 38

Ce manuel d'instruction décrit le carte de commande des KEB COMBIVERT de la serie F5. Il est à utiliser avec les manuels d'instruction Partie 1 et Partie 2. L'ensemble des manuels d'instruction doit être fournit à l'utilisateur. Avant d'intervenir sur l'appareil, l'utilisateur doit se familiarisé lui-même avec l'appareil. Ceci inclu de respecter les remarques de sécurité et de mise en garde de la partie 1. Les pictogrammes utilisés dans ce manuel ont la signification suivante:



**Danger
Avertissement
Précaution**



**Attention,
à respecter
obligatoirement**



**Information
Aide
Astuces**

GB

Page
GB - 3.... GB - 38

This Instruction Manual describes the control circuit of the KEB COMBIVERT F5 series. It is only valid together with the Instruction Manuals Part 1 and Part 2. Both Instruction Manuals must be made available to the user. Prior to performing any work on the unit the user must familiarize himself with the unit. This includes especially the knowledge and observance of the **safety and warning directions of Part 1**. The pictographs used in this Instruction Manual have following meaning:



**Danger
Warning
Caution**



**Attention,
observe at
all costs**



**Information
Help
Tip**

I

Pagina
I - 3 I - 38

Questo manuale d'istruzione descrive il circuito di controllo delle serie KEB COMBIVERT F5. E' valido solo unitamente ai manuali parte 1 e parte 2. Entrambi i manuali d'istruzione devono essere resi disponibili all'utente. Prima di procedere a qualsiasi lavoro sull'apparecchiatura l'utente deve familiarizzare con la stessa. Questo include in special modo la conoscenza e l'osservanza delle direttive di sicurezza e delle avvertenze della parte 1. I simboli utilizzati in questo manuale hanno il seguente significato:



**Avvertimento
Pericolo
Cautela**



**Attenzione,
osservare
assolutamente**



**Informzione
Aiuto
Suggerimento**

E

Pagina
E - 3 E - 38

Este manual de instrucciones describe las series estándar del KEB COMBIVERT F5. Este manual de instrucciones debe ser accesible a todos los usuarios. Antes de conectar el convertidor, el usuario debe de familiarizarse con el convertidor, especialmentedebe de tene en cuenta las medias de seguridad y advertencias. Los pictogramas utilizados en este manual tienen los significados siguientes:



**Peligro
Advertencia
Precaución**



**Atención,
de obligado
cumplimiento**



**Información
Ayuda
Nota**

RU

Страницы
RU - 3 RU - 38

Эта инструкция описывает Карта управления преобразователя частоты KEB COMBIVERT F5. Она действительна только совместно с инструкциями часть 1и часть 2. Все инструкции должны быть доступны для каждого пользователя. Прежде чем приступить к работе, каждый пользователь должен тчательно ознакомиться с прибором. Особено это касается изучения и соблюдения требований к **Безопасности и Предупреждениям из части 1**. Ниже приведённые пиктограммы означают следующее.



**Опасность
Предупреждение
Осторожно**



**Внимание
обязательно
соблюдать**



**Информация
Указание
Совет**

1.	Installation and Connection	4
1.1	Control Circuit GENERAL	4
1.1.1	Assignment of Terminal Strip X2A	4
1.1.2	Connection of the Control	5
1.1.3	Digital Inputs	5
1.1.4	Analog Inputs	5
1.1.5	Voltage Input / External Power Supply	6
1.1.6	Digital Outputs	6
1.1.7	Relay Output	6
1.1.8	Analog Output	6
1.1.9	Voltage Output	6
1.2	Control Circuit BASIC	7
1.2.1	Assignment of Terminal Strip X2A	7
1.2.2	Connection of the Control	7
1.2.3	Digital Inputs	8
1.2.4	Analog Inputs	8
1.2.5	Analog Output	8
1.2.6	Relay Outputs	8
2.	Operation of the Unit	9
2.1	Operator	9
2.1.1	Keyboard	10
2.2	Parameter Summary	11
2.3	Passwort Input	12
2.4	Operating Display	12
2.5	Basic Adjustment of the Drive	14
2.6	Special Adjustments	17
2.7	The Drive Mode	28
2.7.1	Start / Stop Drive	28
2.7.2	Changing the Direction of Rotation	28
2.7.3	Preseting the Set Value	28
2.7.4	Leaving the Drive Mode	28
3.	Error Diagnosis	29
4.	Quick Reference	35

1. Installation and Connection

1.1. Control Circuit GENERAL

X2A



1.1.1 Assignment of Terminal Strip X2A

PIN	Function	Name	Description	
1	+ Set value input 1	AN1+	Difference voltage	resolution: 12 Bit (B-housing: 11 Bit), scan time: 1 ms
2	- Set value input 1	AN1-	$0 \dots \pm 10 \text{ VDC} \wedge 0 \dots \pm \text{CP.11}$	
3	+ Analog input 2	AN2+	$0 \dots \pm 10 \text{ VDC} \wedge 0 \dots \pm 100 \%$	
4	- Analog input 2	AN2-		
5	Analog output 1	ANOUT1	Analog output of the real speed $0 \dots \pm 10 \text{ VDC} \wedge 0 \dots \pm 100 \text{ Hz}$	Voltage range: $0 \dots \pm 10 \text{ V}$ Ri=100 Ohm, resolution: 12 Bit
6	Analog output 2	ANOUT2	Analog output of the apparent current $0 \dots 10 \text{ VDC} \wedge 0 \dots 2 \times I_N$	PWM frequency: 3,4 kHz filter response 1. order: 178 Hz
7	+10V Output	CRF	Reference voltage for set value poti	+10 VDC +5% / max. 4 mA
8	Analog Mass	COM	Mass for analog in- and outputs	
9	Analog Mass	COM	Mass for analog in- and outputs	
10	Fixed frequency 1	I1	I1+I2 = fixed frequency 3 (default: 70 Hz)	Ri = 2,1 kOhm scan time: 1 ms
11	Fixed frequency 2	I2	no input = analog set value	
12	External fault	I3	Input for external fault stopping mode	
13	DC-braking	I4	Activates the DC-braking	
14	Forward	F	Preset rotation;	
15	Reverse	R	Forward has priority	
16	Control release / Reset	ST	Power modules are enabled; Error Reset at opening	
17	Reset	RST	Reset; only when an error occurs	
18	Speed dependent	O1	Transistor output switched at factual = fset	
19	Ready signal	O2	Transistor output switched, as long as no error occurs	
20	24V-Output	U _{out}	Approx. 24V output (max.100 mA)	
21	20...30V-Input	U _{in}	Voltage input for external supply	
22	Digital Mass	0V	Potential for digital in-/outputs	
23	Digital Mass	0V	Potential for digital in-/outputs	
24	Relay 1/NO contact	RLA	Relay output; fault relay (default);	max. 30 V DC, 1 A;
25	Relay 1/NC contact	RLB	Function can be	
26	Relay 1/switching contact	RLC	changed with CP.31	
27	Relay 2/NO contact	FLA	Relay output;	
28	Relay 2/NC contact	FLB	frequency dependent switch (default);	
29	Relay 2/switching contact	FLC	Function can be changed with CP.32	

GB

1.1.2 Connection of the Control

In order to prevent a malfunction caused by interference voltage supply on the control inputs, the following directions should be observed:



- Use shielded/drilled cables
- Lay shield **on one side** of the inverter onto earth potential
- Lay control and power cable **separately** (about 10...20 cm apart)
- Lay crossings in a right angle (in case it cannot be prevented)

1.1.3 Digital Inputs

Use of **internal** voltage supply

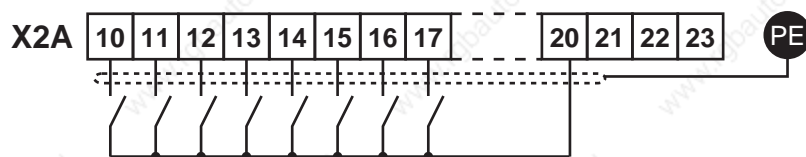

Use of **external** voltage supply

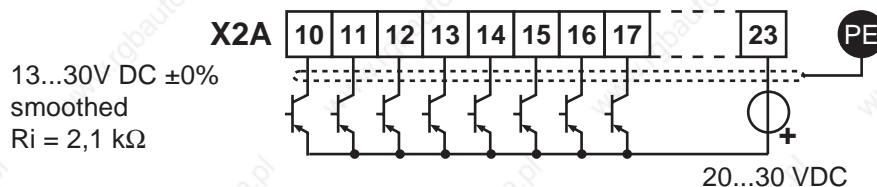

GB

1.1.4 Analog Inputs

Connect unused analog inputs to common, to prevent set value fluctuations!

External analog set-point setting (see CP.35)

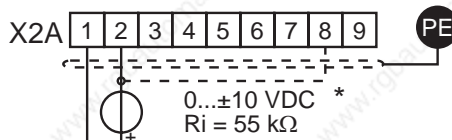

Internal analog set-point setting

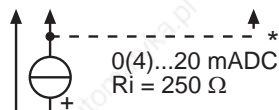
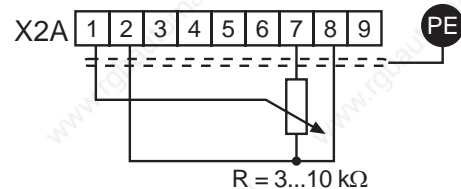

*) Connect potential equalizing line only if a potential difference of > 30 V exists between the controls. The internal resistance is reduced to 30 kΩ.

1.1.5 Voltage Input / External Power Supply

The supply of the control circuit through an external voltage source keeps the control in operational condition even if the power stage is switched off. To prevent undefined conditions at external power supply the basic procedure is to first switch on the power supply and after that the inverter.

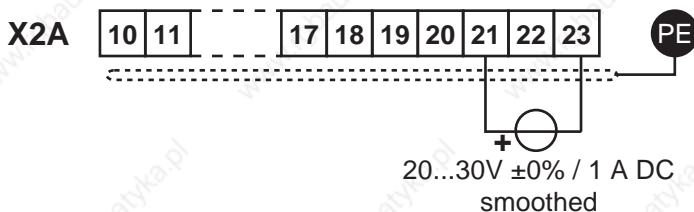

1.1.6 Digital Outputs

GB

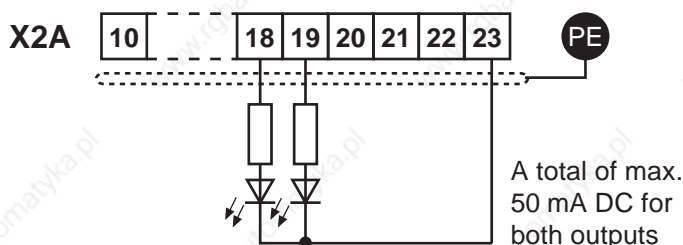

1.1.7 Relay Outputs

In case of inductive load on the relay outputs a protective wiring must be provided (e.g. free-wheeling diode, see Part 1.2.6)!

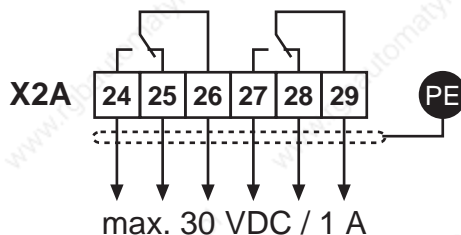

1.1.8 Analog Outputs

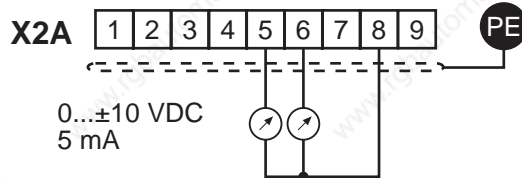

1.1.9 Voltage Output

The voltage output serves for the setting of the digital inputs as well as for the supply of external control elements. Do not exceed the maximum output current of 100 mA.

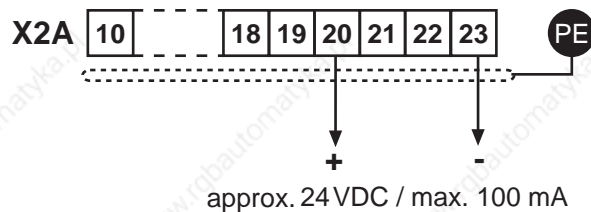

1.2 Control Circuit BASIC

X2A

1.2.1 Assignment of Terminal Strip X2A

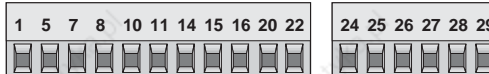

PIN	Function	Name	Description
1	± Set value input 1	AN1	Voltage input 0...±10 VDC Δ 0...±CP.11 resolution: 11 Bit, scan time: 2 ms
5	Analog output 1	ANOUT1	Analog output of the real frequency 0...±10 VDC Δ 0...±100 Hz voltage range: 0...±10V Ri=100 Ohm, resolution: 12bit
7	+10V Output	CRF	Supply voltage for set value poti +10 VDC +5% / max. 4 mA
8	Analog Mass	COM	Mass for analog In- and Outputs
10	Fixed frequency 1	I1	I1 + I2 = Fixed frequency 3; no input = analog set value Ri = 2,1 kOhm scan time: 2 ms
11	Fixed frequency 2	I2	
14	Forward	F	Preset rotation; Ri = 2,1 kOhm
15	Reverse	R	Forward has priority scan time: 2 ms
16	Control release/Reset	ST	Power modules are enabled; Error Reset at opening Ri = 2,1 kOhm scan time: 2 ms
20	24V-Output	U _{out}	approx 24V Output (max.100 mA)
22	Digital Mass	0V	Potential for digital In-/Outputs
24	Relay 1/NO contact	RLA	Relay output; fault relay(default) Function can be changed with CP.31; max. 30 V DC, 1 A
25	Relay 1/NC contact	RLB	
26	Relay 1/switching cont.	RLC	
27	Relay 2/NO contact	FLA	Relay output; frequency dependent switch (default); Function can be changed with CP.32; max. 30 V DC, 1 A
28	Relay /NC contact	FLB	
29	Relay 2/switching cont.	FLC	

1.2.2 Connection of the control

In order to prevent a malfunction caused by interference voltage supply on the control inputs, the following directions should be observed:



- Use shielded/drilled cables
- Lay shield **on one side** of the inverter onto earth potential
- Lay control and power cable **separately** (about 10...20 cm apart)
- Lay crossings in a right angle (in case it cannot be prevented)

1.2.3 Digital Inputs

Use of **internal** voltage supply

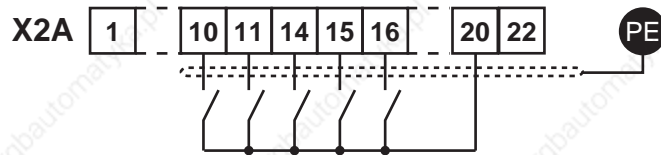

Use of **external** voltage supply

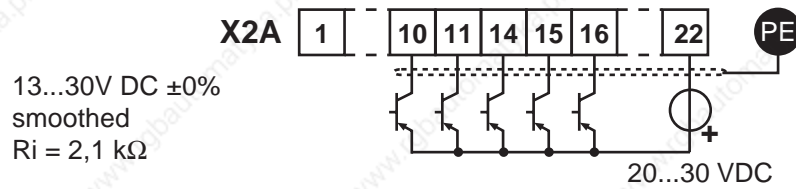

GB

1.2.4 Analog Inputs

Internal analog
set-point setting

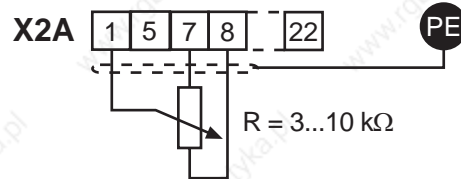

External analog
set-point setting

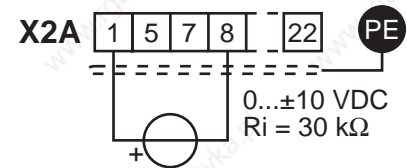

1.2.5 Analog Output

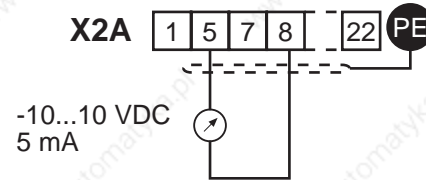

1.2.6 Relay Outputs

In case of inductive load on the relay output a protective wiring must be provided (e.g. free-wheeling diode)!

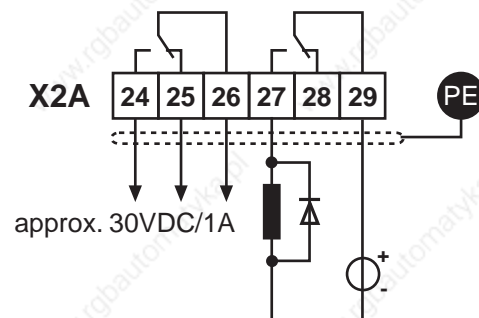

2. Operation of the Unit

As an accessory to the local or external (option: cable 00.F5.0C0-1xxx) programming an operator is necessary. To prevent malfunctions, the inverter must be brought into **nOP** status before connecting / disconnecting the operator (open control release terminal). When starting the inverter without an operator, it is started with the last stored values or factory setting.

2.1 Digital Operator

Digital Operator Standard: Part No. 00.F5.060-1000

Interface Operator with serial Interface: Part No. 00.F5.060-2000

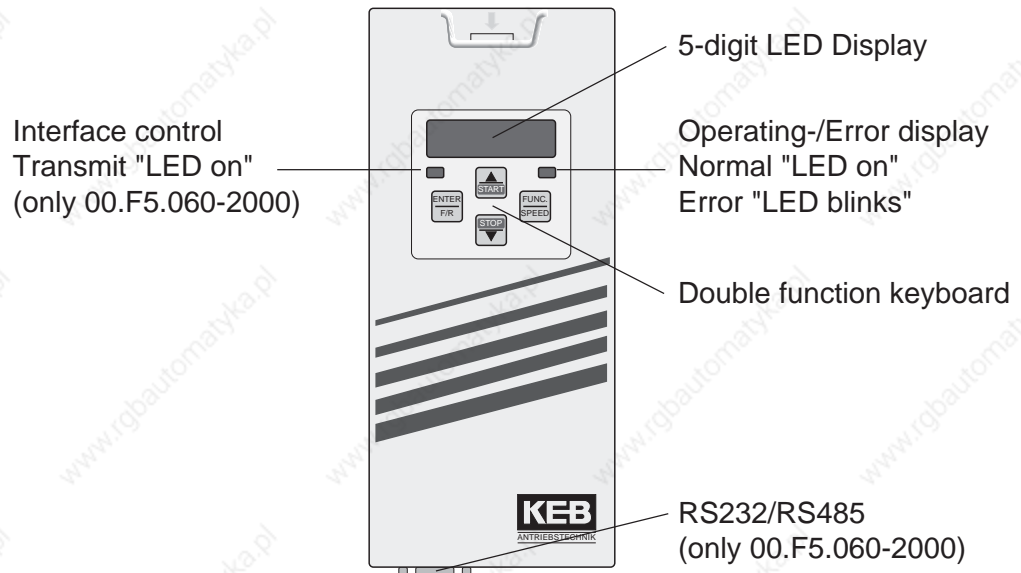

GB



Only use the **operator interface** for the serial data transfer to RS232/485. The direct connection, PC to the inverter is only valid with a **special cable (HSP5 Part No. 00.F5.0C0-0001)**, otherwise, it would lead to the destruction of the PC-interface.



PIN	RS485	Signal	Meaning
1	—	—	reserved
2	—	TxD	Transmitter signal/RS232
3	—	RxD	Receiver signal/RS232
4	A'	RxD-A	Receiver signal A/RS485
5	B'	RxD-B	Receiver signal B/RS485
6	—	VP	Voltage supply-Plus +5V ($I_{max} = 10 \text{ mA}$)
7	C/C'	DGND	Data reference potential
8	A	TxD-A	Transmitter signal A/RS485
9	B	TxD-B	Transmitter signal B/RS485

RS232-cable 3m
PC / Operator
Part. No. 00.58.025-001D

9-pole SUB-D coupling

9-pole SUB-D connector

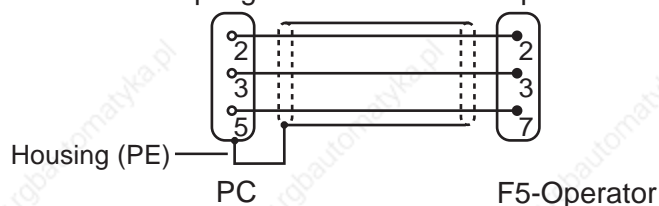

2.1.1 Keyboard

When switching on KEB COMBIVERT F5 the value of parameter CP.1 appears. (see Drive mode to switch the keyboard function)

The **function key** (FUNC) changes between the parameter value and parameter number.



With **UP** (▲) and **DOWN** (▼) the value of the parameter number is increased/decreased with **changeable** parameters.

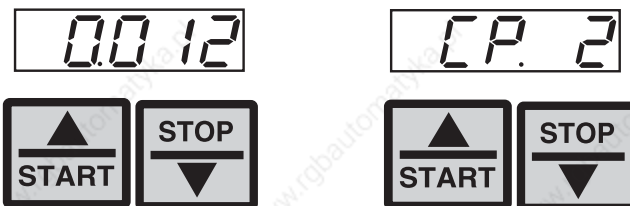

Principally during a change, parameter values are immediately accepted and stored non-volatile. However, with some parameters it is not useful that the adjusted value is accepted immediately. In these cases (CP.17, CP.18, CP.22, CP.26, CP.29, CP.31, CP.32, CP.34, CP.35) the adjusted value is accepted and stored non-volatile by pressing **ENTER**.

If a malfunction occurs during operation, then the actual display is overwritten by the alarm message. The alarm message in the display is reset by ENTER.



With ENTER only the error message in the display is reset. In the inverter status display (CP.3) the error is still displayed. In order to reset the error itself, the cause must be removed or a power-on reset must be made.

2.2 Parameter Summary

Display	Parameter	Setting range	Resolution	Factory setting
CP. 0	Password input	0...9999	1	–
CP. 1	Actual frequency display	–	0,0125 Hz	–
CP. 2	Set frequency display	–	0,0125 Hz	–
CP. 3	Inverter status display	–	–	–
CP. 4	Apparent current	–	0,1 A	–
CP. 5	Apparent current / Peak value	–	0,1 A	–
CP. 6	Utilization	–	1 %	–
CP. 7	Intermediate circuit voltage	–	1 V	–
CP. 8	Intermediate circuit voltage/ Peak value	–	1 V	–
CP. 9	Output voltage	–	1 V	–
CP.10	Minimal frequency	0...400 Hz	0,0125 Hz	0 Hz
CP.11	Maximal frequency	0...400 Hz	0,0125 Hz	70 Hz
CP.12	Acceleration time	0,00...300,00 s	0,01 s	5,00 s
CP.13	Deceleration time(-1 see CP.12)	-1; 0,00...300,00 s	0,01 s	5,00 s
CP.14	S-curve time	0,00 (off)...5,00 s	0,01 s	0,00 s (off)
CP.15	Boost	0,0...25,5 %	0,1 %	2,0 %
CP.16	Rated frequency	0...400 Hz	0,0125 Hz	50 Hz
CP.17 ¹⁾	Voltage stabilization	1...650 V (off)	1 V	650 (off)
CP.18 ¹⁾	Carrier frequency	2/4/8/12/16 kHz ²⁾	–	– ²⁾
CP.19	Step frequency 1	-400...400 Hz	0,0125 Hz	5 Hz
CP.20	Step frequency 2	-400...400 Hz	0,0125 Hz	50 Hz
CP.21	Step frequency 3	-400...400 Hz	0,0125 Hz	70 Hz
CP.22 ¹⁾	DC-braking / Mode	0...9	1	7
CP.23	DC-braking / Time	0,00...100,00 s	0,01 s	10,00 s
CP.24	Max. ramp current	0...200 %	1 %	140 %
CP.25	Max. constant current	0...200 % (off)	1 %	200 % (off)
CP.26 ¹⁾	Speed search condition	0...15	1	8
CP.27	Quick stop time	0,00...300,00 s	0,01 s	2,00 s
CP.28	Reaction of ext. overtemperature	0...7	1	7
CP.29 ¹⁾	Analog output 1 / Function	0...20	1	2
CP.30	Analog output 1 / Amplification	-20,00...20,00	0,01	1,00
CP.31 ¹⁾	Relay output 1 / Function	0...68	1	4
CP.32 ¹⁾	Relay output 2 / Function	0...68	1	27
CP.33	Relay output 2 / Switching level	0,00...±30000,00	0,01	4,00
CP.34 ¹⁾	Source of rotation direction	0...9	1	2
CP.35 ¹⁾	AN1 interface selection	0...2	1	0
CP.36	AN1 zero point hysteresis	-10,0...10,0 %	0,1 %	0,2 %

¹⁾ Enter-Parameter

²⁾ depending on power circuit

2.3 Password Input

CP. 0

Ex works the frequency inverter is supplied without password protection, this means that all changeable parameters can be adjusted. After parameterizing the unit can be barred against unauthorized access (Passwords: see last but one page). The adjusted mode is stored.

Barring the CP-Parameter

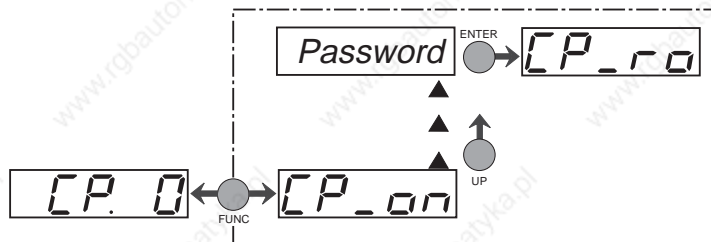

Enabling the CP-Parameter

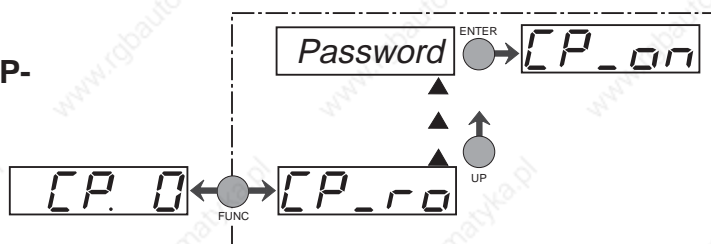

GB

2.4 Operating Display

The parameters below serve for the controlling of the frequency inverter during operation.

Actual frequency display

CP. 1

Display of the actual output frequency with a resolution of 0.0125 Hz. The operator displays additionally „noP“ and „LS“ if the control release or the direction of rotation are not switched (see CP.3). The rotation of the inverter is indicated by the sign.

Examples:

18.3	Output frequency 18.3 Hz, rotation forward
- 18.3	Output frequency 18.3 Hz, rotation reverse

Set frequency

CP. 2

Display of actually set frequency. The indication is done in the same manner as at CP.1. For control reasons the set frequency is displayed even if control release or direction of rotation are not switched. If no direction of rotation is set, the set frequency for clockwise rotation (forward) is displayed.

Inverter status display

CP. 3

The status display shows the actual working conditions of the inverter. Possible displays and their meanings are:

noP

"no Operation" control release not bridged, modulation switched off, output voltage = 0 V, drive is not controlled.

LS

"Low Speed" no rotation preset, modulation switched off, output voltage = 0 V, drive is not controlled.

FACC

"Forward Acceleration" drive accelerates with direction of rotation forward .

FdEc

"Forward Deceleration" drive decelerates with direction of rotation forward.

rAcc

"Reverse Acceleration" drive accelerates with direction of rotation reverse.

rdEc

"Reverse Deceleration" drive decelerates with direction of rotation reverse.

Fcon

"Forward Constant" drive runs with a constant speed and direction of rotation forward.

rcon

"Reverse Constant" drive runs with constant speed and direction of rotation reverse.

Other status messages are described at the parameters, where they occur.

GB

Apparent current

CP. 4

Display of the actual apparent current in ampere.

Apparent current / Peak value

CP. 5

CP.5 makes it possible to recognize the max. apparent current. For that the highest value of CP.4 is stored in CP.5. The peak value memory can be cleared by pressing the UP, DOWN or ENTER key or over bus by writing any value you like to the address of CP.5. The switch off of the inverter also clears the memory.

Utilization

CP. 6

Display of the actual inverter rate of utilization in percent. 100% rate of utilization is equal to the inverter rated current. Only positive values are displayed, meaning there is no differentiation between motor and regenerative operation.

Intermediate circuit voltage

CP. 7

Display of actual DC voltage in volt.
Typical values:

V-class	Normal operation	Over volt. (E.OP)	Under volt. (E.UP)
230 V	300...330 V DC	approx. 400 V DC	approx. 216 V DC
400 V	530...620 V DC	approx. 800 V DC	approx. 240 V DC

Intermediate circuit voltage/Peak value

CP. 8

CP.8 makes it possible to recognize short-time voltage rises within an operating cycle. For that the highest value of CP.7 is stored in CP.8. The peak value memory can be cleared by pressing the UP, DOWN or ENTER key or over bus by writing any value you like to the address of CP.8. The switch off of the inverter also clears the memory.

Output voltage

CP. 9

Display of the actual output voltage in volt.

2.5 Basic Adjustment of the Drive

The following parameters determine the fundamental operating data of the drive. They should be checked and/or adapted to the application.

GB

Minimum frequency

CP. 10

With this frequency the inverter operates without presetting an analog set value. Internal limiting of the fixed frequencies CP.19...CP.21.

Adjustment range: 0...400 Hz
Resolution: 0,0125 Hz
Factory setting: 0,0 Hz

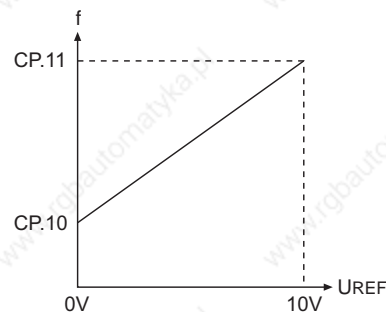

Maximum frequency

CP. 11

With this frequency the inverter operates with maximum analog set value. Internal limiting of the fixed frequencies CP.19...CP.21.

Adjustment range: 0...400 Hz
Resolution: 0,0125 Hz
Factory setting: 70 Hz

Acceleration time

CP.12

The parameter determines the time needed to accelerate from 0 Hz to 100 Hz. The actual acceleration time is proportional to the frequency change.

$$\frac{100 \text{ Hz}}{\Delta f} \times \text{actual acceleration time} = \text{CP.12}$$

Adjustment range: 0,00...300,00 s
 Resolution: 0,01 s
 Factory setting: 5,00 s

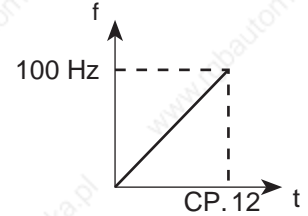

Example: actual acceleration time = 5s; the drive should accelerate from 10 Hz to 60 Hz. $\Delta f = 60 \text{ Hz} - 10 \text{ Hz} = 50 \text{ Hz}$

$$\text{CP.12} = (100 \text{ Hz} / 50 \text{ Hz}) \times 5 \text{ s} = 10 \text{ s}$$

Deceleration time

CP.13

The parameter determines the time needed to decelerate from 100 Hz to 0 Hz. The actual deceleration time is proportional to the frequency change.

$$\frac{100 \text{ Hz}}{\Delta f} \times \text{actual deceleration time} = \text{CP.13}$$

Adjustment range: -1; 0,00...300,00 s
 Resolution: 0,01 s
 Factory setting: 5,00 s

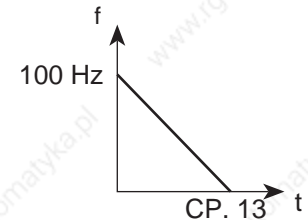

At -1 deceleration time → see CP.12 (Display: "=Acc")!

Example: actual deceleration time = 5s; the drive should decelerate from 60 Hz to 10 Hz. $\Delta f = 60 \text{ Hz} - 10 \text{ Hz} = 50 \text{ Hz}$

$$\text{CP.12} = (100 \text{ Hz} / 50 \text{ Hz}) \times 5 \text{ s} = 10 \text{ s}$$

S-curve time

CP.14

For some applications it is of advantage when the drive starts and stops jerk-free. This is achieved through a straightening of the acceleration and deceleration ramps. The straightening time, also called S-curve time, can be adjusted with CP.14.

Adjustment range: 0,00 (off)...5,00 s
 Resolution: 0,01 s
 Factory setting: 0,00 s (off)



In order to drive defined ramps with activated S-curve time, the acceleration and deceleration times (CP.12 and CP.13) must be adjusted higher than the S-curve time (CP.14).

Ramp adjustment with S-curves

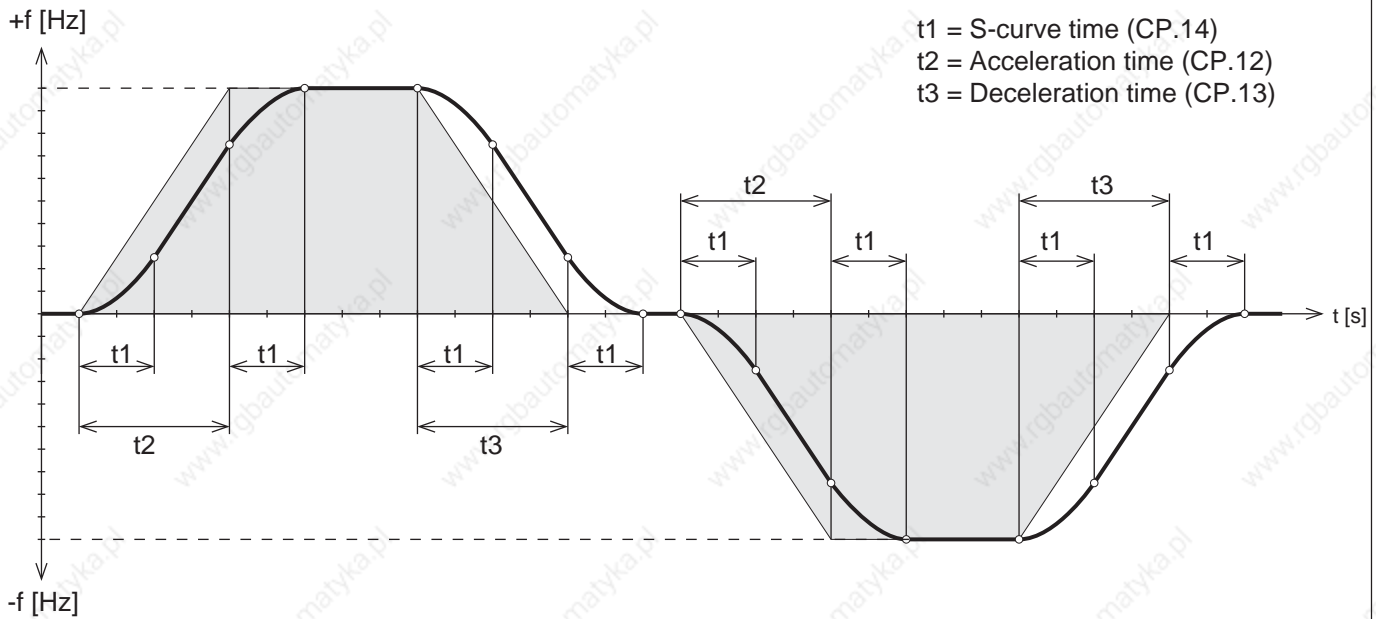

GB

Boost

CP. 15

In the lower speed range a large part of the motor voltage decreases on the stator resistance. To keep the breakdown torque nearly constant over the entire speed range, the voltage decrease can be compensated with the boost.

Adjustment range: 0,0...25,5 %
 Resolution: 0,1 %
 Factory setting: 2,0 %

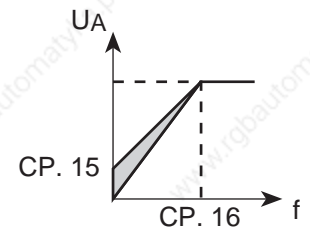

- Adjustment:
- Determine the rate of utilization in no-load operation with rated frequency
 - Preset about 10 Hz and adjust the boost, so that about the same rate of utilization is reached as with the rated frequency.



When the motor, during continuous operation, drives with low speed and too high voltage it can lead to an overheating of the motor.

Rated frequency

CP. 16

With the adjusted frequency the inverter reaches a maximal output voltage. The adjustment of the rated motor frequency is typical in this case. **Note: Motors can overheat when the rated frequency is incorrectly adjusted!**

Adjustment range: 0...400 Hz
 Resolution: 0,0125 Hz
 Factory setting: 50 Hz

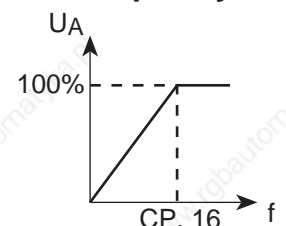

2.6 Special Adjustments

Voltage stabilization



The following parameters serve for the optimization of the drive and the adaption to certain applications. These adjustments can be ignored at the initial startup.

With this parameter a regulated output voltage in relation to the rated frequency can be adjusted. For that reason voltage variations at the input as well as in the intermediate circuit only have a small influence on the output voltage (U/f-characteristic). The function allows, among other things, an adaption of the output voltage to special motors.

Adjustment range:	1...650 V (off)
Resolution:	1 V
Factory setting:	650 V (off)
Note:	Enter-Parameter

In the example below the output voltage is stabilized to 230 V (0% boost).

GB

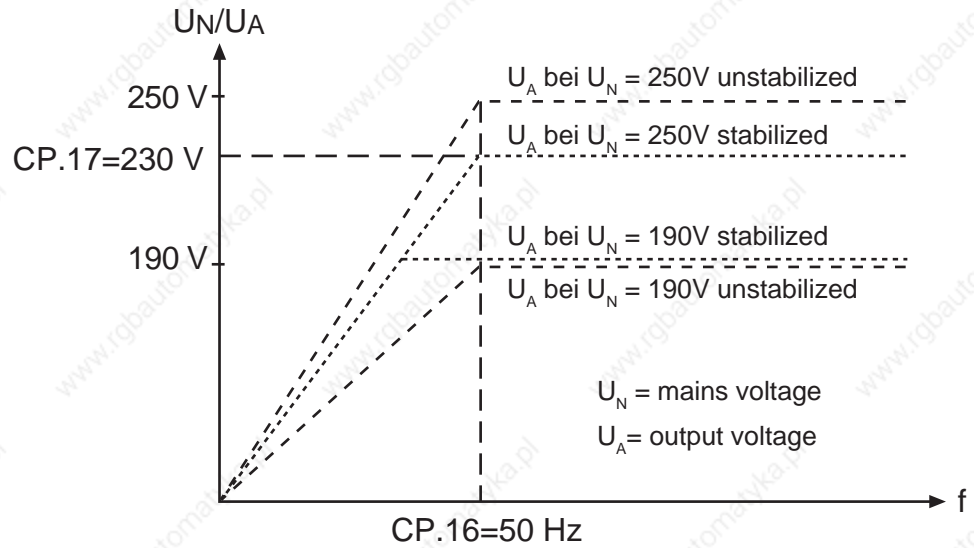

Carrier frequency

CP.18

The switching frequency with which the power modules are clocked can be changed depending on the application. The employed power stage determines the maximum switching frequency as well as the factory setting (see manual: part2). Refer to following list to learn about influences and effects of the switching frequency.

low switching frequency	high switching frequency
<ul style="list-style-type: none"> • less inverter heating • less discharge current • less switching losses • less radio interferences • improved concentricity with low speed 	<ul style="list-style-type: none"> • less noise development • improved sine-wave simulation • less motor losses

Adjustment range (dep. on power circuit): 2/4/8/12/16 kHz
 Factory setting: depending on power circuit
 Note: Enter-Parameter

GB



At switching frequencies above 4 kHz pay absolute attention to the max. motor line length in the technical data of the power circuit manual (Part 2).

Step frequency 1...3

Input I1

CP.19

Input I2

CP.20

Input I1 and I2

CP.21

Three fixed frequencies can be adjusted. The fixed frequencies are selected with the inputs I1 and I2.

Adjustment range: -400...400 Hz
 Resolution: 0,0125 Hz
 Factory setting CP.19: 5 Hz
 Factory setting CP.20: 50 Hz
 Factory setting CP.21: 70 Hz

If adjustments are made that are outside the fixed limits of CP.10 and CP.11, then the frequency is internally limited. The negative values are released in application mode.

The rotation source of the fixed frequencies is not changed by CP.34, it always corresponds to CP.34 = 2.

DC-braking / Mode



With DC-braking the motor is not decelerated by the ramp. Quick braking is caused by D.C. voltage, which is applied onto the motor winding. This parameter determines how the dc-braking is triggered.

Value	Activation
0	DC-braking; deactivated
1	DC-braking; at switch off of the direction of rotation and upon reaching 0Hz. The braking time is CP.23 or until the next direction of rotation.
2*	DC-braking; as soon as setting for the direction of rotation is absent.
3*	DC-braking; as soon as the direction of rotation changes or is absent.
4*	DC-braking; on disabling the direction of rotation and if the real frequency falls below 4 Hz.
5*	DC-braking; when the real frequency falls below 4 Hz.
6*	DC-braking; as soon as the set value falls below 4 Hz.
7*	DC-braking; when input I4 is switched. Braking time depends on the real frequency. At control circuit B = value "0"
8	DC-braking; as long as input I4 is switched. At control circuit B = value "0"
9	DC-braking; after switching on the modulation on.

GB

* Braking time depends on the actual frequency.

Adjustment range:	0...9
Resolution:	1
Factory setting:	7
Note:	Enter-Parameter

DC-braking / Time



If the braking time depends on the actual frequency (CP.22 = 2...7), it is calculated as follows:

$$t_{\text{Breal}} = \frac{\text{CP.23} \times f_{\text{real}}}{100 \text{ Hz}}$$

Otherwise the braking time corresponds to CP.23.

Adjustment range:	0,00...100,00 s
Resolution:	0,01 s
Factory setting:	10,00 s

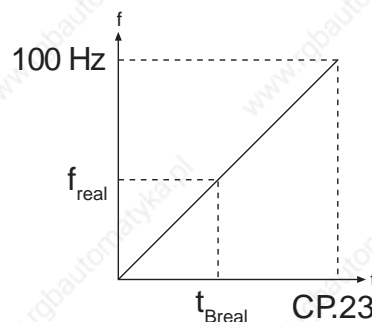

Max. ramp current

CP.24

This function protects the frequency inverter against switching off through overcurrent during the acceleration ramp. When the ramp reaches the adjusted value, it is stopped so long until the current decreases again. CP.3 displays "LAS" at active function.

Adjustment range:	0...200 %
Resolution:	1 %
Factory setting:	140 %

Max. constant current

CP.25

This function protects the frequency inverter against switch off through overcurrent during constant output frequency. When exceeding the adjusted value, the output frequency is reduced until the value drops below the adjusted value. CP. 3 displays "SSL" at active function.

Adjustment range:	0...200 % (off)
Resolution:	1 %
Factory Setting:	200 % (off)

GB

Utilization

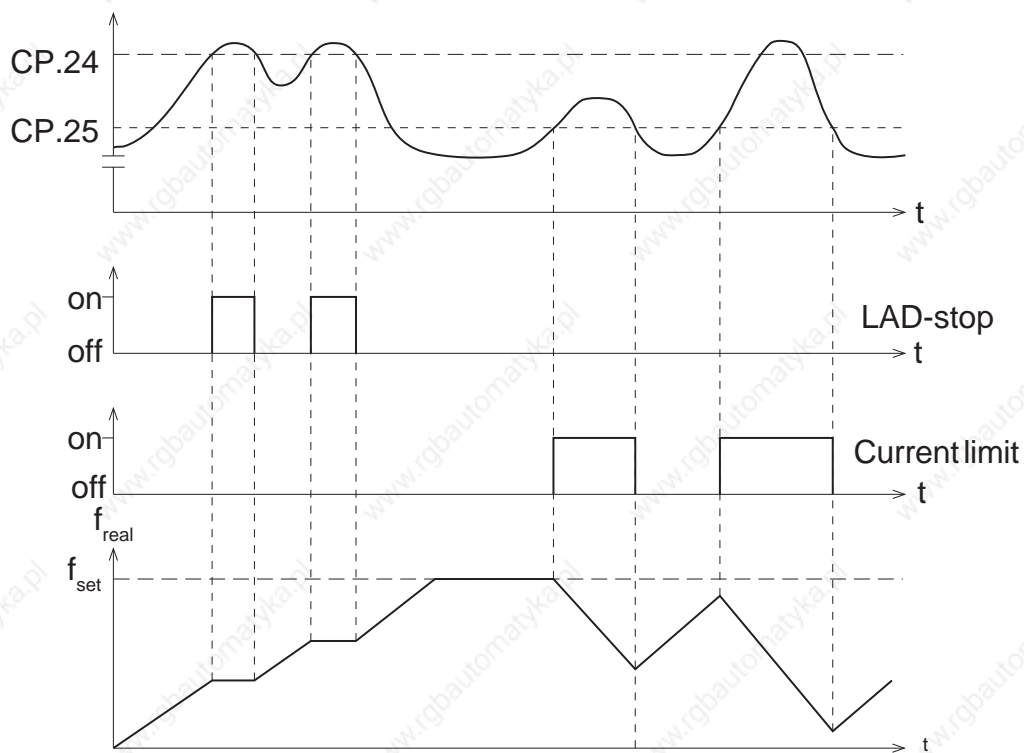

Speed search condition

CP.26

When connecting the frequency inverter onto a decelerating motor, an error can be triggered by the differing rotating field frequencies. With activated speed search the inverter searches for the actual motor speed, adapts its output frequency and accelerates with the adjusted ramp to the given set value. During speed search CP.3 displays "SSF". The parameter determines, under what conditions the functions operate. In case of several conditions the sum of the value must be entered.

Example: CP.26 = 12 means after reset **and** after auto-reset UP.

Value	Condition
0	function off
1	at control release
2	at switch on
4	after reset
8	after Auto-Reset UP

GB

Adjustment range: 0...15
 Resolution: 1
 Factory setting: 8
 Note: Enter-Parameter

Quick stop time

CP.27

The fast-stop function is activated depending on CP.28. The parameter determines the time needed to decelerate from 100 Hz to 0 Hz. The actual deceleration time is proportional to the frequency change. The response to overtemperature (CP.28) is disabled in the factory setting. If it is activated then the modulation switches off automatically after 10 s if the motor is still too hot.

$$\frac{100 \text{ Hz}}{\Delta f} \times \text{actual deceleration time} = \text{CP.27}$$

Adjustment range: 0,00...300,00 s
 Resolution: 0,01 s
 Factory setting: 2,00 s

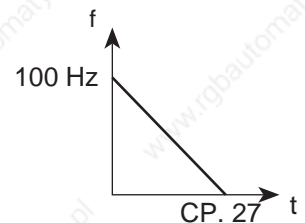

Example: actual deceleration time = 5s; the drive should decelerate from 50 Hz to 0 Hz. $\Delta f = 50 \text{ Hz} - 0 \text{ Hz} = 50 \text{ Hz}$

$$\text{CP.27} = (100 \text{ Hz} / 50 \text{ Hz}) \times 5 \text{ s} = 10 \text{ s}$$

Reaction of external overtemperature

CP.28

This parameter determines the response of the drive on the external temperature monitoring. In order to activate this function the power circuit terminals T1/T2 must be connected in accordance with the instruction manual Part 2. After that the response can be adjusted according to following table.



Factory setting = off

If overheat no longer exists, the message E.ndOH (or A.ndOH) is output. Only then the error can be reset or the automatic restart can be carried out.

CP.28	Display	Reaction	Restart
0	E.dOH	Immediate disabling of modulation	Remove fault; Actuate reset
1 *	A.dOH	Quick stopping / disabling of modulation after reaching speed 0	
2 *	A.dOH	Quick stopping/holding torque at speed 0	
3	A.dOH	Immediate disabling of modulation	Automatic reset, if the fault is no longer present
4 *	A.dOH	Quick stopping / disabling of modulation after reaching speed 0	
5 *	A.dOH	Quick stopping/holding torque at speed 0	
6 *	no	No effect on the drive; With CP.31/32 = 9 an external module can be controlled (e.g. fan)	- inapplicable -
7	no	No effect on the drive; !Fault don't exists! External Temperature monitoring is not activated	

*) If the motor is still too hot after 10 seconds, the error E.dOH is triggered and the modulation is switched off!

Adjustment range:	0...7
Resolution:	1
Setting range:	7

Analog output 1 / Function

CP.29 defines the function of analog output 1.

CP.29

Value	Function	
0	Absolute actual value (CP.1)	100Hz = 100%
1	Absolute set value (CP.2)	100Hz = 100%
2	Actual value (CP.1)	±100Hz = ±100%
3	Set value (CP.2)	±100Hz = ±100%
4	Output voltage (CP.9)	500V = 100%
5	Intermediate circuit (DC) voltage (CP.7)	1000V = 100%
6	Apparent current (CP.4)	2 x rated current = 100%
7	Active current	±2 x rated current = ±100%
8-10	Only application-mode	
11	Absolute active current	2 x rated current = 100%
12	Power module temperature	100 °C = 100%
13	Motor temperature	100 °C = 100%
14-18	Only application-mode	
19	Ramp output frequency	±100Hz = ±100%
20	Absolut ramp output frequency	100Hz = ±100%

GB

Adjustment range: 0...20
 Resolution: 1
 Factory setting: 2
 Note: Enter-Parameter

Analog output 1 / Amplification

CP.30

With the amplification the output voltage of the analog output can be tuned the signal to be given out. An amplification of 1 corresponds to ±100 % = ±10 V.

Adjustment range: -20,00...20,00
 Resolution: 0,01
 Factory setting: 1,00

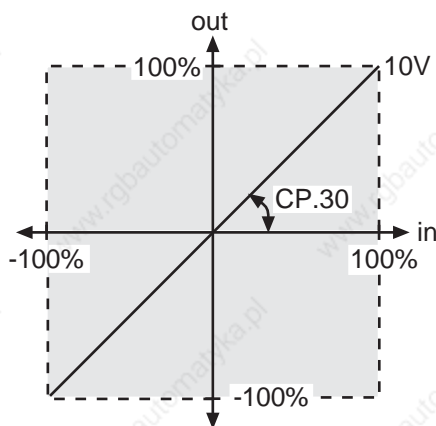

Setting aid:

The analog output shall give out +10 V at 70 Hz instead at 100 Hz:

$$CP.30 = \frac{100 \text{ Hz}}{70 \text{ Hz}} = 1,43$$

Relay output 1 / Function

CP.31

Relay output 2 / Function

CP.32

CP.31 and CP.32 determine the function of the two outputs.

CP.31 for relay output 1 (terminal X2A.24...X2A.26)

CP.32 for relay output 2 (terminal X2A.27...X2A.29)

The switching level of CP.31 is 100,00.

The switching level of CP.32 is CP.33!

GB

Value	Function
0	No function (generally off)
1	Generally on
2	Run signal; also by DC-braking
3	Ready signal (no error)
4	Fault relay
5	Fault relay (no auto-reset)
6	Warning or error message at abnormal stopping
7	Overload alert signal
8	Overtemperature alert signal power modules
9	External Overtemperature alert signal motor
10	Only application-mode
11	Overtemperature alert signal interior OHI
12	Cable breakage 4...20 mA on analog input 1
13	Only application-mode
14	Max. constant current (stall, CP.25) exceeded
15	Max. ramp current (LA-Stop CP.24) exceeded
16	DC-braking active
17-19	Only application-mode
20	Actual value=set value (CP.3=Fcon, rcon; not at noP, LS error,SSF)
21	Accelerate (CP.3 = FAcc, rAcc, LAS)
22	Decelerate (CP.3 = FdEc, rdEc, LdS)
23	Real direction of rotation = set direction of rotation
24	Utilization (CP.6) > 100%
25	Active current > switching level
26	Intermediate circuit voltage (CP.7)>switching level
27	Real value (CP.1) > switching level
28	Set value (CP.2) > switching level
29/30	Only application-mode
31	Absolut set value on AN1 > switching level
32	Absolut set value on AN2 > switching level
33	Only application-mode
34	Set value on AN1 > switching level
35	Set value on AN2 > switching level
36-39	Only application-mode
40	Hardware current limit activated
41	Modulation on-signal
42-43	Only application-mode
44	Inverter status (CP.3) = switching level
45	Power module temperatur > Level

Value	Function
46	Motor temperatur > Level
47	Ramp output frequency > Level
48	Apparent current (CP.4) > Level
49	Clockwise rotation (not at noP, LS, abnormal stopping, Fehler)
50	Counter clockwise (not at noP, LS, abnormal stopping, Fehler)
51-62	Only application-mode
63	Absolut ANOUT1 > switching level
64	Absolut ANOUT2 > switching level
65	ANOUT1 > switching level
66	ANOUT2 > switching level
67-68	Only application-mode

Factory setting CP.31: 4
 Factory setting CP.32: 27
 Note: Enter-Parameter

GB

**Relay output 2 /
Switching level**



This parameter determines the switching point for the relay output 2 (CP.32). After the switching of the relay, the value can move within a window (hysteresis), without the relay dropping off. Since the operator can display only 5 characters, the last digits are not represented in the case of higher values.

Adjustment range: -30000,00...30000,00
 Resolution: 0,01
 Factory setting: 4,00
 Hysteresis:
 Frequency: 0,5 Hz
 Intermediate circuit voltage: 1 V
 Analog set value: 0,5 %
 Active current: 0,5 A
 Temperature: 1 °C

Source of rotation direction

CP.34

The source rotation setting and the mode of evaluating the rotation setting is defined with this parameter (Enter-Parameter). With CP.34 one does not modify the rotation source of the fixed frequencies (CP.19... 21).

Value	Function
0/1	Only application mode
2	Setting by way of terminal strip forward/reverse; negative set values are set to zero (factory setting)
3	Setting by way of terminal strip forward/reverse; the signs of the setpoint values have no effect on the direction of rotation
4	Setting by way of terminal strip run/stop (X2A.14) and forward/reverse (X2A.15); negative values are set to zero
5	Setting by way of terminal strip run/stop (X2A.14) and forward/reverse; the signs of the setpoint values have no effect on the direction of rotation
6	Set value dependent, positive value - clockwise rotation; negative value-counter-clockwise rotation; with set value "0" it is switched into status "Low speed" (LS)
7	Set value dependent, positive value - clockwise rotation; clockwise rotation is indicated
8/9	Only application mode

GB

Set value
0-limited
(Value 2 and 4)

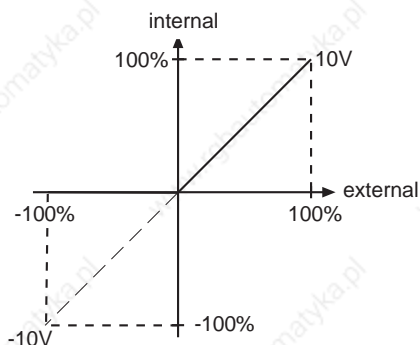

Set value
absolute
(Value 3 and 5)

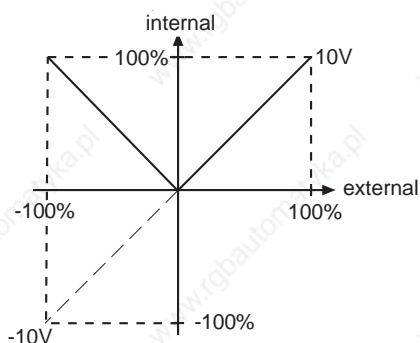

Adjustment range: 0...9
Resolution: 1
Factory setting: 2
Note: Enter-Parameter

AN1 Interface selection

CP.35

The set value input 1 (AN1) at the F5-GENERAL control can be triggered by various signal levels. In order to correctly evaluate the signal, this parameter must be adapted to the signal source. At the F5-BASIC control the signal source may not be re-adjusted.

Value	Reference signal
0	0...±10 V DC / Ri = 56 kOhm
1	0...+20 mA DC / Ri = 250 Ohm
2	4...20 mA DC / Ri = 250 Ohm

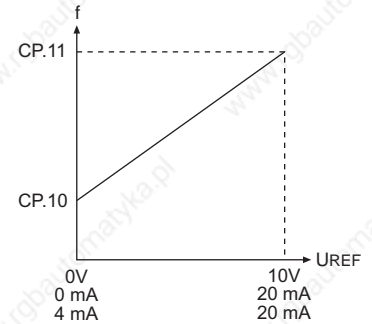

Adjustment range: 0...2
 Resolution: 1
 Factory setting: 0
 Note: Enter-Parameter

GB

AN1 Zero point hysteresis

CP.36

Through capacitive as well as inductive coupling on the input lines or voltage fluctuations of the signal source, the motor connected to the inverter may start to drift inspite of the analog input filters. It is the function of the zero point hysteresis to suppress this drifting.

With parameter CP.36 the analog signal for the input REF can be faded out in the range of 0...±10%. The adjusted value is valid for both directions of rotation.

If a negative percentage value is adjusted then the hysteresis is not only effective on the zero point but also around the actual set value. Set value changes during constant operation are accepted only when they are larger than the adjusted hysteresis.

Adjustment range: -10,0...10,0 %
 Resolution: 0,1 %
 Factory setting: 0,2 %

2.7 The Drive Mode

The Drive Mode is a operating mode of KEB COMBIVERT that permits the manual starting of the drive by the operator. After switching the control release the set value and rotation setting are effected exclusively over the keyboard. In order to activate the Drive Mode the corresponding **password** (see last but one page) must be entered **in CP.0**. The display switches over as follows.

2.7.1 Start / Stop Drive

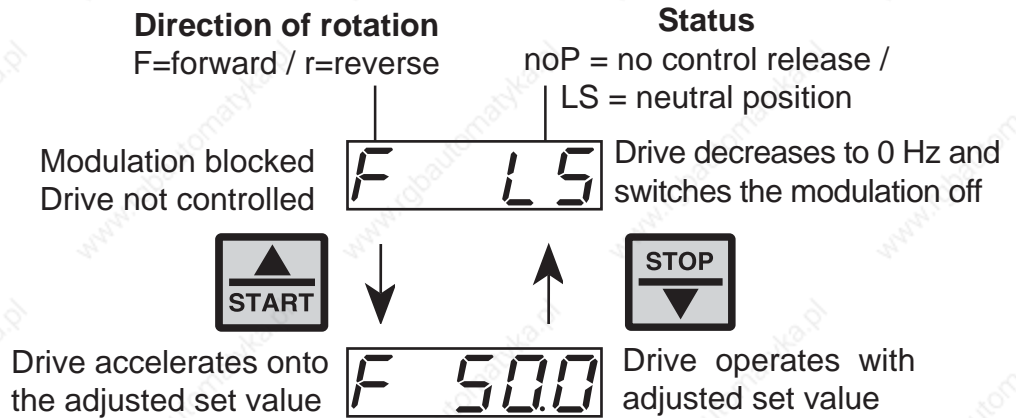

2.7.2 Changing the Direction of Rotation

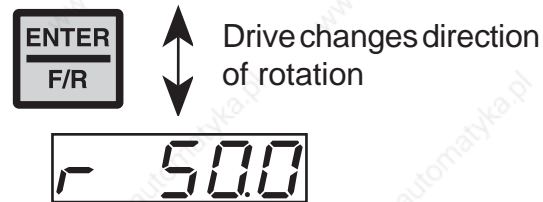

2.7.3 Preseting the Set Value

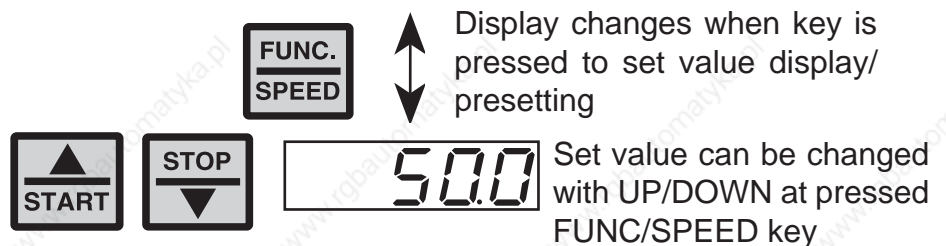

2.7.4 Leaving the Drive Mode

To exit the drive mode the inverter must be in status “stop” (Display noP or LS). Press the FUNC and ENTER keys simultaneously for about 3 seconds to leave the drive mode. The CP-parameters appear in the display.



3. Error Diagnosis

At KEB COMBIVERT **error messages** are always represented with an „E.“ and the appropriate error in the display. Error messages cause the immediate deactivation of the modulation. Restart possible only after reset.

Malfunction are represented with an „A.“ and the appropriate message. Reactions to malfunctions can vary.

In the following the display and their cause are described.

Display	COMBIVIS	Value	Meaning
	Status Messages		
bbL	base block	76	Power modules for motor de-excitation locked
bon	close brake	85	Brake control, brake engaged (see chapter 6.9)
boFF	open brake	86	Brake control, brake released (see chapter 6.9)
Cdd	calculate drive	82	Measurement of the motor stator resistance
dcb	DC brake	75	Motor is decelerated by a DC-voltage at the output.
dLS	low speed / DC brake	77	Modulation is switched off after DC-braking (see chapter 6.9 „DC-Braking“).
FAcc	forward acceleration	64	Acceleration with the adjusted ramps in clockwise direction of rotation.
Fcon	forward constant	66	Acceleration / deceleration phase is completed and it is driven with constant speed / frequency in clockwise direction of rotation.
FdEc	forward deceleration	65	It is stopped with the adjusted ramp times in clockwise direction of rotation.
HCL	hardware current limit	80	The message is output if the output current reaches the hardware current limit.
LAS	LA stop	72	This message is displayed if during acceleration the load is limited to the adjusted load level.
LdS	Ld stop	73	This message is displayed if during deceleration the load is limited to the adjusted load level or the DC-link current to the adjusted voltage level.
LS	low speed	70	No direction of rotation pre-set, modulation is off.
nO_PU	power unit not ready	13	Power circuit not ready or not identified by the control.
noP	no operation	0	Control release (terminal ST) is not switched.
PA	positioning active	122	This message is displayed during a positioning process.
PLS	low speed / power off	84	No modulation after Power-Off
PnA	position not reachable	123	The specified position cannot be reached within the pre-set ramps. The abort of the positioning can be programmed.
POFF	power off function	78	Depending on the programming of the function (see chapter 6.9 „Power-off Function“) the inverter restarts automatically upon system recovery or after a reset.
POSI	positioning	83	Positioning function active (F5-G).
rAcc	reverse acceleration	67	Acceleration with the adjusted ramp times in anti-clockwise direction of rotation.
rcon	reverse constant	69	The acceleration / deceleration phase is completed and it is driven with constant speed / frequency in anti-clockwise direction of rotation.

Display	COMBIVIS	Value	Meaning
rdEc	reverse deceleration	68	It is stopped with the adjusted ramp times in anti-clockwise direction of rotation.
rFP	ready for positioning	121	The drive signals that it is ready to start the positioning process.
SLL	stall	71	This message is displayed if during constant operation the load is limited to the adjusted current limit.
SrA	search for ref. active	81	Search for reference point approach active.
SSF	speed search	74	Speed search function active, that means that the inverter attempts to synchronize onto a running down motor.
StOP	quick stop	79	The message is output if as response to a warning signal the quick-stop function becomes active.
Error Messages			
E. br	ERROR brake	56	Error: This error can occur in the case of switched on brake control (see Chapter 6.9.5), if <ul style="list-style-type: none"> • the load is below the minimum load level (Pn.43) at start up or the absence of an engine phase was detected. • the load is too high and the hardware current limit is reached
E.buS	ERROR bus	18	Error: Adjusted monitoring time (Watchdog) of communication between operator and PC / operator and inverter has been exceeded.
E.Cdd	ERROR calc. drive data	60	Error: During the automatic motor stator resistance measurement.
E.co1	ERROR counter overrun 1	54	Counter overflow encoder channel 1
E.co2	ERROR counter overrun 2	55	Counter overflow encoder channel 2
E.dOH	ERROR drive overheat	9	Error: Overtemperature of motor PTC. Error can only be reset at E.ndOH, if PTC is again low-resistance. Causes: <ul style="list-style-type: none"> • resistance at the terminals T1/T2 >1650 Ohm • motor overloaded • line breakage to the temperature sensor
E.dri	ERROR driver relay	51	Error: Driver relay. Relay for driver voltage on power circuit has not picked up even though control release was given.
E.EEP	ERROR EEPROM defective t	21	After reset the operation is again possible (without storage in the EEPROM)
E. EF	ERROR external fault	31	Error: External error. Is triggered, if a digital input is being programmed as external error input and trips.
E.EnC	ERROR encoder	32	Error: Cable breakage resolver or incremental encoder
E.Hyb	ERROR hybrid	52	Invalid encoder interface identifier
E.HybC	ERROR hybrid changed	59	Error: Encoder interface identifier has changed, it must be confirmed over ec.0 or ec.10.
E.iEd	ERROR input error detect	53	Error at PNP/NPN switching or input failure.
E.InI	ERROR initialisation MFC	57	MFC not booted.

Display	COMBIVIS	Value	Meaning
E.LSF	ERROR load shunt fault	15	Error: Load-shunt relay has not picked up, occurs for a short time during the switch-on phase, but must automatically be reset immediately. If the error message remains the following causes may be applicable: <ul style="list-style-type: none"> • load-shunt defective • input voltage wrong or too low • high losses in the supply cable • braking resistor wrongly connected or damaged • braking module defective
E.ndOH	no ERROR drive overheat	11	Motor temperature switch or PTC at the terminals T1/T2 is again in the normal operating range. The error can be reset now.
E.nOH	no E. over heat pow.mod.	36	Temperature of the heat sink is again in the permissible operating range. The error can be reset now.
E.nOHI	no ERROR overheat int.	7	No longer overheating in the interior E.OHI, interior temperature has fallen by at least 3°C
E.nOL	no ERROR overload	17	No more overload, OL-counter has reached 0%; after the error E. OL a cooling phase must elapse. This message appears upon completion of the cooling phase. The error can be reset. The inverter must remain switched on during the cooling phase.
E.nOL2	no ERROR overload 2	20	The cooling time has elapsed. The error can be reset.
E. OC	ERROR overcurrent	4	Error: Overcurrent Occurs, if the specified peak current is exceeded. Causes: <ul style="list-style-type: none"> • acceleration ramps too short • the load is too big at turned off acceleration stop and turned off constant current limit • short-circuit at the output • ground fault • deceleration ramp too short • motor cable too long • EMC • DC brake at high ratings active (see 6.9.3)
E. OH	ERROR overheat pow.mod.	8	Error: Overtemperature of power module. Error can only be reset at E.nOH. Causes: <ul style="list-style-type: none"> • insufficient air flow at the heat sink (soiled) • ambient temperature too high • ventilator clogged
E.OH2	ERROR motor protection	30	Electronic motor protective relay has tripped.
E.OHI	ERROR overheat internal	6	Error: Overheating in the interior: error can only be reset at E.nOHI, if the interior temperature has dropped by at least 3°C
E. OL	ERROR overload (lxt)	16	Error: Overload error can only be reset at E.nOL, if OL-counter reaches 0% again. Occurs, if an excessive load is applied longer than for the permissible time (see technical data). Causes: <ul style="list-style-type: none"> • poor control adjustment (overshooting) • mechanical fault or overload in the application • inverter not correctly dimensioned • motor wrongly wired • encoder damaged

Display	COMBIVIS	Value	Meaning
E.OL2	ERROR overload 2	19	Occurs if the standstill constant current is exceeded (see technical data and overload characteristics). The error can only be reset if the cooling time has elapsed and E.nOL2 is displayed.
E. OP	Error! Overvoltage	1	Voltage in the DC-link circuit too high. Occurs if the DC-link circuit voltage exceeds the permissible value. Causes: <ul style="list-style-type: none"> • poor controller adjustment (overshooting) • input voltage too high • interference voltages at the input • deceleration ramp too short • braking resistor defective or too small
E.OS	ERROR over speed	58	Real speed is bigger than the max. Output speed.
E.PFC	ERROR Power factor control	33	Error in the power factor control
E.PrF	ERROR prot. rot. for.	46	The drive has driven onto the right limit switch. Programmed response "Error, restart after reset" (see chapter 6.7 "Response to errors or warning messages").
E.Prr	ERROR prot. rot. rev.	47	The drive has driven onto the left limit switch. Programmed response "Error, restart after reset" (see chapter 6.7 "Response to errors or warning messages").
E. Pu	ERROR power unit	12	Error: General power circuit fault
E.Puci	ERROR pow. unit code inv.	49	Error: During the initialization the power circuit could not be recognized or was identified as invalid.
E.Puch	ERROR power unit changed	50	Error: Power circuit identification was changed; with a valid power circuit this error can be reset by writing to SY.3. If the value displayed in SY.2 is written, only the power-circuit dependent parameters are reinitialized. If any other value is written, then the default set is loaded. On some systems after writing Sy.3 a Power-On-Reset is necessary.
E.PUCO	ERROR power unit commun.	22	Error: Parameter value could not be written to the power circuit. Acknowledgement from PC <> OK
E.PUIN	ERROR power unit invalid	14	Error: Software version for power circuit and control card are different. Error cannot be reset (only at F5-G B-housing)
E.SbuS	ERROR bus synchron	23	Synchronization over sercos-bus not possible. Programmed response "Error, restart after reset" (see chapter 6.7 "Response to errors or warning messages").
E.SET	ERROR set	39	It has been attempted to select a locked parameter set. Programmed response "Error, restart after reset" (see chapter 6.7 "Response to errors or warning messages").
E.SLF	ERROR! Software limit switch forward	44	The right software limit switch lies outside the defined limits. Programmed response "Error, restart after reset" (see chapter 6.7 "Response to errors or warning messages").
E.SLr	ERROR software limit switch reverse	45	The left software limit switch lies outside the defined limits. Programmed response "Error, restart after reset" (see chapter 6.7 "Response to errors or warning messages").

Display	COMBIVIS	Value	Meaning
E. UP	ERROR underpotential	2	Error: Undervoltage (DC-link circuit). Occurs, if DC-link voltage falls below the permissible value. Causes: <ul style="list-style-type: none"> • input voltage too low or instable • inverter rating too small • voltage losses through wrong cabling • the supply voltage through generator / transformer breaks down at very short ramps • At F5-G housing B E.UP is also displayed if no communication takes place between power circuit and control card. • Jump factor (Pn.56) too small (see 6.9.20) • if a digital input was programmed as external error input with error message E.UP (Pn.65).
E.UPh	ERROR Phase failure	3	One phase of the input voltage is missing (ripple-detection)
Warning Messages			
A.buS	ABN.STOP bus	93	Warning: Watchdog for communication between operator/control card or operator/PC has responded. The response to this warning can be programmed (see chapter 6.7 "Response to errors and warning messages").
A.dOH	ABN.STOP drive over heat	96	The motor temperature has exceeded an adjustable warning level. The switch off time is started. The response to this warning can be programmed (see chapter 6.7 "Response to errors or warning messages"). This warning can be generated only with a special power circuit.
A. EF	ABN.STOP external fault	90	This warning is triggered via an external input. The response to this warning can be programmed (see chapter 6.7 "Response to errors or warning messages").
A.ndOH	no A. drive overheat	91	The motor temperature is again below the adjusted warning level. The switch off time is stopped.
A.nOH	no A. overheat pow.mod.	88	The heat sink temperature is again below the adjusted warning level.
A.nOHI	no A.STOP overheat int.	92	The temperature in the interior of the inverter is again below the warning threshold.
A.nOL	no ABN.STOP overload	98	Warning: no more overload, OL counter has reached 0 %.
A.nOL2	no ABN.STOP overload 2	101	The cooling time after "Warning! Overload during standstill" has elapsed. The warning message can be reset.
A. OH	A.STOP overheat pow.mod	89	A level can be defined, when it is exceeded this warning is output. A response to this warning can be programmed (see chapter 6.7 "Response to errors or warning messages").
A.OH2	ABN.STOP motor protect.	97	Warning: electronic motor protective relay has tripped. The response to this warning can be programmed (see chapter 6.7 "Response to error or warning messages").
A.OHI	ABN.STOP overheat int.	87	The temperature in the interior of the inverter lies above the permissible level. The switch off time was started. The programmed response to this warning message is executed (see chapter 6.7 "Response to errors or warning messages").

Display	COMBIVIS	Value	Meaning
A. OL	ABN.STOP overload	99	A level between 0 and 100 % of the load counter can be adjusted, when it is exceeded this warning is output. The response to this warning can be programmed (see chapter 6.7 "Response to errors or warning messages").
A.OL2	ABN.STOP overload 2	100	The warning is output when the standstill continuous current is exceeded (see technical data and overload characteristics). The response to this warning can be programmed (see chapter 6.7 "Response to errors and warning messages"). The warning message can only be reset after the cooling time has elapsed and A.nOL2 is displayed.
A.PrF	ABN.STOP prot. rot. for.	94	The drive is driven onto the right limit switch. The response to this warning can be programmed (see chapter 6.7 "Response to errors and warning messages").
A.Prr	ABN.STOP prot. rot. rev.	95	The drive is driven onto the left limit switch. The response to this warning can be programmed (see chapter 6.7 "Response to errors and warning messages").
A.SbuS	ABN.Bus synchron	103	Synchronization over sercos-bus not possible. The response to this warning can be programmed (see chapter 6.7 "Response to errors and warning messages").
A.SET	ABN.STOP set	102	Warning: set selection: It has been attempted to select a locked parameter set. The response to this warning can be programmed (see chapter 6.7 "Response to errors or warning messages").
A.SLF	ABN.Software limit switch forward	104	The right software limit switch lies outside the defined limits. The response to this warning can be programmed (see chapter 6.7 "Response to errors or warning messages").
A.SLr	ABN.Software limit switch reverse	105	The left software limit switch lies outside the defined limits. The response to this warning can be programmed (see chapter 6.7 "Response to errors or warning messages").

4. Quick Reference

Display	Parameter	Setting range	Resolution	Customer setting
CP. 0	Password input	0...9999	1	—
CP. 1	Actual frequency display	—	0,0125 Hz	—
CP. 2	Set frequency display	—	0,0125 Hz	—
CP. 3	Inverter status display	—	—	—
CP. 4	Apparent current	—	0,1 A	—
CP. 5	Apparent current / Peak value	—	0,1 A	—
CP. 6	Utilization	—	1 %	—
CP. 7	Intermediate circuit voltage	—	1 V	—
CP. 8	Intermediate circuit voltage/ Peak value	—	1 V	—
CP. 9	Output voltage	—	1 V	—
CP.10	Minimal frequency	0...400 Hz	0,0125 Hz	_____
CP.11	Maximal frequency	0...400 Hz	0,0125 Hz	_____
CP.12	Acceleration time	0,00...300,00 s	0,01 s	_____
CP.13	Deceleration time(-1 see CP.12)	-1; 0,00...300,00 s	0,01 s	_____
CP.14	S-curve time	0,00 (off)...5,00 s	0,01 s	_____
CP.15	Boost	0,0...25,5 %	0,1 %	_____
CP.16	Rated frequency	0...400 Hz	0,0125 Hz	_____
CP.17 ¹⁾	Voltage stabilization	1...650 V (off)	1 V	_____
CP.18 ¹⁾	Carrier frequency	2/4/8/12/16 kHz ²⁾	-	_____
CP.19	Step frequency 1	-400...400 Hz	0,0125 Hz	_____
CP.20	Step frequency 2	-400...400 Hz	0,0125 Hz	_____
CP.21	Step frequency 3	-400...400 Hz	0,0125 Hz	_____
CP.22 ¹⁾	DC-braking / Mode	0...9	1	_____
CP.23	DC-braking / Time	0,00...100,00 s	0,01 s	_____
CP.24	Max. ramp current	0...200 %	1 %	_____
CP.25	Max. constant current	0...200 % (off)	1 %	_____
CP.26 ¹⁾	Speed search condition	0...15	1	_____
CP.27	Quick stop time	0,00...300,00 s	0,01 s	_____
CP.28	Reaction of ext. overtemperature	0...7	1	_____
CP.29 ¹⁾	Analog output 1 / Function	0...20	1	_____
CP.30	Analog output 1 / Amplification	-20,00...20,00	0,01	_____
CP.31 ¹⁾	Relay output 1 / Function	0...68	1	_____
CP.32 ¹⁾	Relay output 2 / Function	0...68	1	_____
CP.33	Relay output 2 / Switching level	0,00...±30000,00	0,01	_____
CP.34 ¹⁾	Source of rotation direction	0...9	1	_____
CP.35 ¹⁾	AN1 interface selection	0...2	1	_____
CP.36	AN1 zero point hysteresis	-10,0...10,0 %	0,1 %	_____

¹⁾ Enter-Parameter

GB

Passwords

	CP Read Only	CP Read/Write	Drive-Mode
	a) 100	b) 200	c) 500

