

Rexroth IndraMotion MTX System Description

R911314882
Edition 01

Project Planning Manual

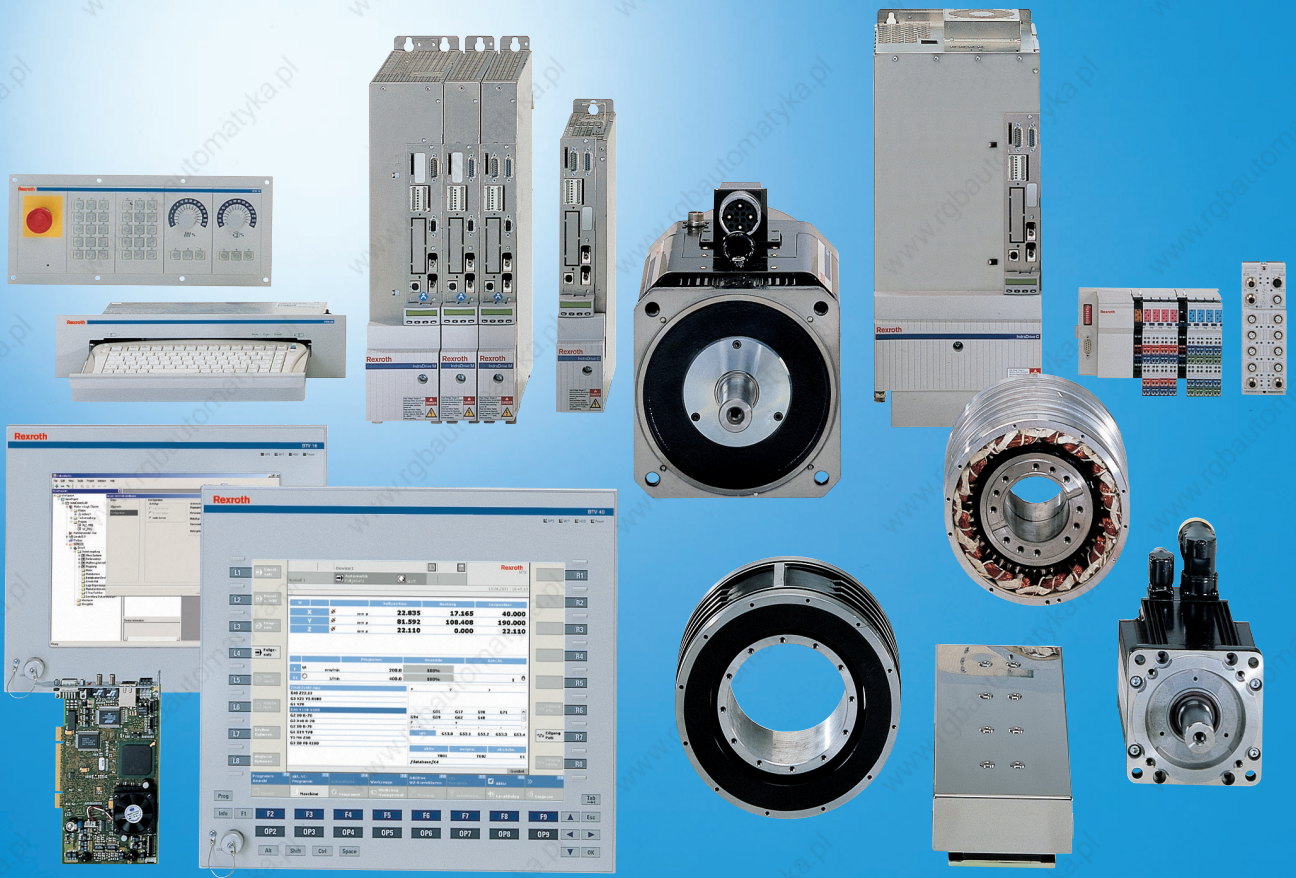

Title	Rexroth IndraMotion MTX System Description
Type of Documentation	Project Planning Manual
Document Typecode	DOK-MTX***-SYS*DES*V04-PR01-EN-P
Internal File Reference	Document Number 120-2500-B322-01/EN
Purpose of Documentation	This documentation describes the Rexroth IndraMotion MTX system.

Record of Revisions

Description	Release Date	Notes
120-2500-B322-01/EN	11.2005	First issue for 04VRS

Copyright © 2005 Bosch Rexroth AG

Copying this document, giving it to others and the use or communication of the contents thereof without express authority, are forbidden. Offenders are liable for the payment of damages. All rights are reserved in the event of the grant of a patent or the registration of a utility model or design (DIN 34-1).

Validity The specified data is for product description purposes only and may not be deemed to be guaranteed unless expressly confirmed in the contract. All rights are reserved with respect to the content of this documentation and the availability of the product.

Published by Bosch Rexroth AG
Bgm.-Dr.-Nebel-Str. 2 • D-97816 Lohr a. Main
Telephone +49 (0)93 52/40-0 • Tx 68 94 21 • Fax +49 (0)93 52/40-48 85
<http://www.boschrexroth.com/>
Dept. BRC/ESM8 (MaMu), BRC/ESM6 (DiHa)

Note This document has been printed on chlorine-free bleached paper.

Contents

1	System Overview	1-1
1.1	Brief Description	1-1
	Documentation References	1-1
1.2	Overview of Industrial PCs	1-2
1.3	Features of a Standard Industrial PC	1-2
1.4	Features of a High-End Industrial PC	1-2
2	Important Directions for Use	2-1
2.1	Appropriate Use	2-1
	Introduction	2-1
	Areas of Use and Application	2-1
2.2	Inappropriate Use	2-2
3	Safety Instructions for Electric Drives and Controls	3-1
3.1	Introduction	3-1
3.2	Explanations	3-1
3.3	Hazards by Improper Use	3-2
3.4	General Information	3-3
3.5	Protection Against Contact with Electrical Parts	3-4
3.6	Protection Against Electric Shock by Protective Low Voltage (PELV)	3-6
3.7	Protection Against Dangerous Movements	3-7
3.8	Protection Against Magnetic and Electromagnetic Fields During Operation and Mounting	3-9
3.9	Protection Against Contact with Hot Parts	3-10
3.10	Protection During Handling and Mounting	3-10
3.11	Battery Safety	3-11
3.12	Protection Against Pressurized Systems	3-11
4	CNC Control Modules CMP 40 and CMP 60	4-1
4.1	Brief Description	4-1
4.2	Performance Data	4-1
4.3	Technical Data	4-2
4.4	Handling	4-2
	Resistance to Climatic Changes	4-2
	Noise Radiation, Immunity (EMC)	4-2
	Service Concept	4-3
4.5	Control and Indicator Components	4-3
	LEDs and External Watchdog Reset Button	4-3
4.6	Interfaces	4-4

	Optional Highspeed I/O Interface	4-5
4.7	Order Type	4-8
	Order Codes in Industrial PCs from Bosch Rexroth	4-8
4.8	Documentation	4-8
5	Standard Industrial PC VSP	5-1
5.1	Brief Description	5-1
5.2	Field of Application	5-2
5.3	Technical Data	5-2
5.4	Types	5-2
5.5	Control Configuration	5-2
5.6	Accessories	5-3
	Connectors and Cable Assemblies	5-3
5.7	Documentation	5-3
6	Standard Industrial PC VSB with Operator Panel VDP	6-1
6.1	Brief Description	6-1
6.2	Field of Application	6-1
6.3	Technical Data	6-2
	VSB 40.1	6-2
	VDP 16/40	6-2
6.4	Types	6-2
6.5	Control Configuration	6-3
6.6	Accessories	6-3
	Connection Cables (GIGASTAR Interface)	6-3
	Fastening Angles	6-3
6.7	Documentation	6-3
7	High-End Industrial PC BTV / VPP	7-1
7.1	Brief Description	7-1
7.2	Field of Application	7-2
7.3	Technical Data	7-2
7.4	Types	7-2
7.5	Control Configuration	7-2
7.6	Accessories	7-3
	Connectors and Cable Assemblies	7-3
7.7	Documentation	7-3
8	High-End Industrial PC IPC 40 and VPB 40 with Operator Panel VDP	8-1
8.1	General Information	8-1
8.2	Types	8-1
8.3	Field of Application	8-2
8.4	Technical Data	8-2
	IPC 40.2 and VPB 40.1	8-2
	VDP 16/40	8-2
8.5	Types	8-2

8.6	Control Configurations	8-3
8.7	Accessories	8-3
	Connection Cables (GIGASTAR Interface)	8-3
	Fastening Angles	8-3
8.8	Documentation	8-3
9	Uninterruptible Power System UPS	9-1
9.1	Brief Description	9-1
9.2	Type	9-1
9.3	Accessories	9-1
	Holder	9-1
9.4	Documentation	9-1
10	External Battery Pack	10-1
10.1	Brief Description	10-1
10.2	Type	10-1
10.3	Accessories	10-1
	Connection Cables	10-1
10.4	Documentation	10-1
11	Machine Control Panel VAM	11-1
11.1	Brief Description	11-1
11.2	Types	11-2
11.3	Accessories	11-2
	Connection Cables (PROFIBUS Interface)	11-2
11.4	Documentation	11-2
12	PC Keyboards VAK and PCK	12-1
12.1	General Information	12-1
12.2	Slide-Out Keyboards	12-1
12.3	Built-In Keyboards	12-2
12.4	Types	12-2
12.5	Documentation	12-3
13	RECO Inline Modules	13-1
13.1	Brief Description	13-1
13.2	Components	13-1
13.3	Documentation	13-1
14	Small Control Panel VCP	14-1
14.1	Brief Description	14-1
14.2	Technical Data	14-3
14.3	Types	14-3
14.4	Accessories	14-3
	Connection Cables (PROFIBUS Interface)	14-3
14.5	Documentation	14-4

15 RECO Fieldline Modules	15-1
15.1 Brief Description	15-1
15.2 Components	15-1
15.3 Documentation.....	15-1
16 Applications	16-1
16.1 Standard Industrial PC VSP 16.1	16-1
16.2 Standard Industrial PC VSP 40.1	16-1
16.3 Standard Industrial PC VSB 40.1 with Operator Panel VDP 16.....	16-2
16.4 Standard Industrial PC VSB 40.1 with Operator Panel VDP 40.....	16-2
16.5 High-End Industrial PC BTV 16.2 / VPP 16.1.....	16-3
16.6 High-End Industrial PC BTV 40.2 / VPP 40.1.....	16-3
16.7 High-End Industrial PC IPC 40.2 / VPB 40.1 with Operator Panel VDP 16	16-4
16.8 High-End Industrial PC IPC 40.2 / VPB 40.1 with Operator Panel VDP 40	16-4
17 Data Backup	17-1
17.1 Introduction	17-1
Overview.....	17-1
Why to Backup Data?.....	17-1
Definition of Hardware and Software Requirements	17-1
17.2 System Presentation.....	17-2
Acronis True Image	17-2
Archive Files	17-3
Incremental Backup.....	17-3
17.3 Acronis Secure Zone and Startup Recovery Manager.....	17-4
Creating the Acronis Secure Zone	17-5
Resizing Acronis Secure Zone	17-6
Reactivating Acronis Startup Recovery Manager.....	17-6
17.4 Creating Image Archives	17-7
17.5 Checking Image Archives	17-8
17.6 Updating and Extending Image Archives	17-8
17.7 Restoring Image Archives.....	17-9
17.8 Exploring Image Archives.....	17-12
Connecting an Image Archive as Drive	17-12
Unplugging Drive Connection.....	17-12
17.9 Creating a Bootable Rescue Media.....	17-13
17.10 Network Support	17-14
Windows Software	17-14
Bootable Rescue Media or Recovery Manager.....	17-14
17.11 Scheduling a Task	17-15
18 Index	18-1
19 Service & Support	19-1
19.1 Helpdesk.....	19-1
19.2 Service-Hotline	19-1

19.3 Internet..... 19-1

19.4 Vor der Kontaktaufnahme... - Before contacting us... 19-1

19.5 Kundenbetreuungsstellen - Sales & Service Facilities..... 19-2

1 System Overview

1.1 Brief Description

Control system MTX is based on the control module CMP 40 and CMP 60, which are used in the industrial PCs. CMP 40 is exclusively used in the standard industrial PCs. CMP 60 is used in the standard industrial PCs and also in the high-end industrial PCs. The CMP 40/60 modules provide both CNC and PLC functionalities. The powerful control module CMP 60 provides CNC performance allowing activation of up to 64 axes in 12 independent CNC processing channels.

In their design and construction, the operator panels of the industrial PCs have been adjusted to further components (machine control panels and PC keyboards) such that they present an optimum solution for controlling, operating and visualizing a machine tool.

Accessories also include cable assemblies allowing the control system MTX to be wired in no time.

Documentation References

Documentation	Type	Material number
Rexroth IndraControl VSP 16.1 / 40.1	DOK-SUPPL*-VSP*16/40**-PRxx-EN-P	R911308264
Rexroth IndraControl VDP 16.1 / 40.1 / 60.1	DOK-SUPPL*-VDP16/40/60-PRxx-EN-P	R911307654
Rexroth BTV 16.2 / 40.2 / 60.2	DOK-SUPPL*-BTV16/40/60-PRxx-EN-P	R911306443
Rexroth IndraControl VPP 16.1 / 40.1 / 60.1	DOK-SUPPL*-VPP*XX.1***-PRxx-EN-P	R911311820
Rexroth VSB 40.1	DOK-SUPPL*-VSB*40.1***-PRxx-EN-P	R911310079
Rexroth IPC 40.2	DOK-SUPPL*-IPC*40.2***-PRxx-EN-P	R911307652
Rexroth VAM 11.1 / 41.1	DOK-SUPPL*-VAM*11/41**-PRxx-EN-P	R911308619
Rexroth VAM 10.1 / 40.1	DOK-SUPPL*-VAM*10/40**-PRxx-EN-P	R911306781
Rexroth VAK 10.1 / 40.1	DOK-SUPPL*-VAK*40.1***-PRxx-EN-P	R911311650
Rexroth VAK 11 / 41	DOK-SUPPL*-VAK*11/41**-PRxx-EN-P	R911310336
Rexroth RECO Inline, PROFIBUS-DP	DOK-CONTRL-R-IL*PBSSYS-AWxx-EN-P	R911289597
Rexroth RECO Inline, PROFIBUS-DP Terminal and Module Supply	DOK-CONTRL-R-IL*PB*-BK-FKxx-EN-P	R911289587
Rexroth RECO Inline, Digital I/O Terminals	DOK-CONTRL-R-IL*DIO***-FKxx-EN-P	R911289589
Rexroth Fieldline, PROFIBUS Devices	DOK-CONTRL-RF-FLS-PB**-PRxx-EN-P	R911298518

Fig. 1-1: Documentation references

1.2 Overview of Industrial PCs

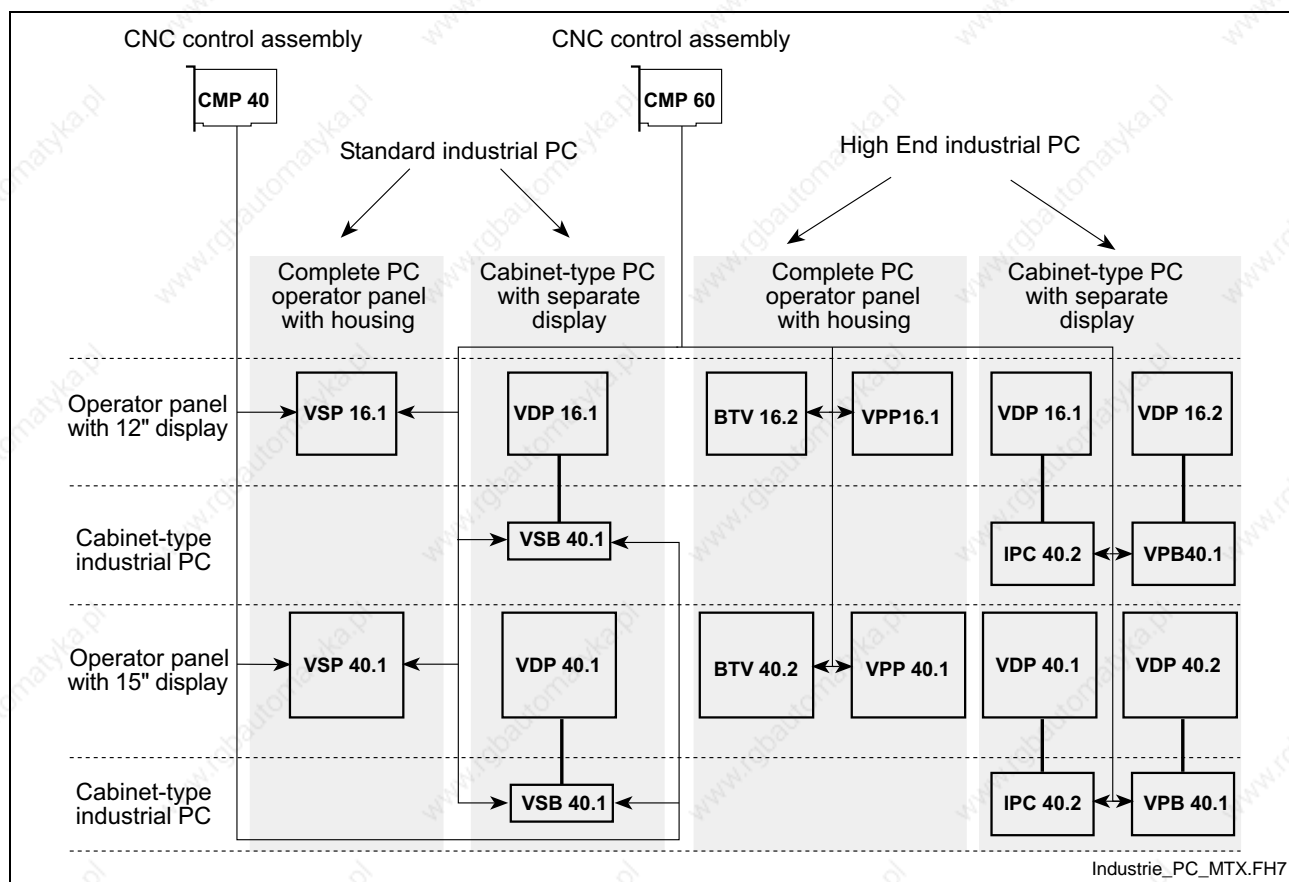

Fig. 1-2: Overview of industrial PCs

1.3 Features of a Standard Industrial PC

- Normal capability for industrial environments (vibration during operation: 0.25 g; shock load: 5 g)
- Standard investment reliability (high component innovation rate)
- Latest PC technology (current processors, motherboards, etc.; available with compatible functionality for at least 2 years)

1.4 Features of a High-End Industrial PC

- High capability for industrial environments (vibration: 1 g; shock load: 15 g)
- High investment reliability (high component continuity rate)
- Long-term availability of components (long-term availability of processors, motherboards, etc.; available with compatible software and functionality for at least 5 years)

2 Important Directions for Use

2.1 Appropriate Use

Introduction

Bosch Rexroth products represent state-of-the-art developments and manufacturing. They are tested prior to delivery to ensure operating safety and reliability.

The products may only be used in the manner that is defined as appropriate. If they are used in an inappropriate manner, then situations can develop that may lead to property damage or injury to personnel.

Note: Bosch Rexroth, as manufacturer, is not liable for any damages resulting from inappropriate use. In such cases, the guarantee and the right to payment of damages resulting from inappropriate use are forfeited. The user alone carries all responsibility of the risks.

Before using Bosch Rexroth products, make sure that all the prerequisites for appropriate use of the products are satisfied:

- Personnel that in any way, shape or form uses our products must first read and understand the relevant safety instructions and be familiar with appropriate use.
- If the product takes the form of hardware, then they must remain in their original state, in other words, no structural changes are permitted. It is not permitted to decompile software products or alter source codes.
- Do not mount damaged or faulty products or use them in operation.
- Make sure that the products have been installed in the manner described in the relevant documentation.

Areas of Use and Application

For the areas of use and application of the respective component, see also the corresponding documentation (documentation reference see p. 1-1).

2.2 Inappropriate Use

Using the devices outside of the above-referenced areas of application or under operating conditions other than described in the document and the technical data specified is defined as "inappropriate use".

The terminals may not be used if

- they are subject to operating conditions that do not meet the above specified ambient conditions. This includes, for example, operation under water, in the case of extreme temperature fluctuations or extreme maximum temperatures or if
- Bosch Rexroth has not specifically released them for that intended purpose. Please note the specifications outlined in the general Safety Instructions!

3 Safety Instructions for Electric Drives and Controls

3.1 Introduction

Read these instructions before the initial startup of the equipment in order to eliminate the risk of bodily harm or material damage. Follow these safety instructions at all times.

Do not attempt to install or start up this equipment without first reading all documentation provided with the product. Read and understand these safety instructions and all user documentation of the equipment prior to working with the equipment at any time. If you do not have the user documentation for your equipment, contact your local Bosch Rexroth representative to send this documentation immediately to the person or persons responsible for the safe operation of this equipment.

If the equipment is resold, rented or transferred or passed on to others, then these safety instructions must be delivered with the equipment.



WARNING

Improper use of this equipment, failure to follow the safety instructions in this document or tampering with the product, including disabling of safety devices, may result in material damage, bodily harm, electric shock or even death!

3.2 Explanations

The safety instructions describe the following degrees of hazard seriousness in compliance with ANSI Z535. The degree of hazard seriousness informs about the consequences resulting from non-compliance with the safety instructions.

Warning symbol with signal word	Degree of hazard seriousness according to ANSI
 DANGER	Death or severe bodily harm will occur.
 WARNING	Death or severe bodily harm may occur.
 CAUTION	Bodily harm or material damage may occur.

Fig. 3-1: Hazard classification (according to ANSI Z535)

3.3 Hazards by Improper Use



DANGER

**High voltage and high discharge current!
Danger to life or severe bodily harm by electric shock!**



DANGER

Dangerous movements! Danger to life, severe bodily harm or material damage by unintentional motor movements!



WARNING

High electrical voltage due to wrong connections! Danger to life or bodily harm by electric shock!



WARNING

Health hazard for persons with heart pacemakers, metal implants and hearing aids in proximity to electrical equipment!



CAUTION

Surface of machine housing could be extremely hot! Danger of injury! Danger of burns!



CAUTION

Risk of injury due to improper handling! Bodily harm caused by crushing, shearing, cutting and mechanical shock or incorrect handling of pressurized systems!



CAUTION

Risk of injury due to incorrect handling of batteries!

3.4 General Information

- Bosch Rexroth AG is not liable for damages resulting from failure to observe the warnings provided in this documentation.
- Read the operating, maintenance and safety instructions in your language before starting up the machine. If you find that you cannot completely understand the documentation for your product, please ask your supplier to clarify.
- Proper and correct transport, storage, assembly and installation as well as care in operation and maintenance are prerequisites for optimal and safe operation of this equipment.
- Only persons who are trained and qualified for the use and operation of the equipment may work on this equipment or within its proximity.
 - The persons are qualified if they have sufficient knowledge of the assembly, installation and operation of the equipment as well as an understanding of all warnings and precautionary measures noted in these instructions.
 - Furthermore, they must be trained, instructed and qualified to switch electrical circuits and equipment on and off in accordance with technical safety regulations, to ground them and to mark them according to the requirements of safe work practices. They must have adequate safety equipment and be trained in first aid.
- Only use spare parts and accessories approved by the manufacturer.
- Follow all safety regulations and requirements for the specific application as practiced in the country of use.
- The equipment is designed for installation in industrial machinery.
- The ambient conditions given in the product documentation must be observed.
- Use only safety features and applications that are clearly and explicitly approved in the Project Planning Manual. If this is not the case, they are excluded.

The following areas of use and application, for example, include safety features and applications: construction cranes, elevators used for people or freight, devices and vehicles to transport people, medical applications, refinery plants, transport of hazardous goods, nuclear applications, applications in which electrical devices with vital functions can be electromagnetically disturbed, mining, food processing, control of protection equipment (also in a machine).
- The information given in the documentation of the product with regard to the use of the delivered components contains only examples of applications and suggestions.

The machine and installation manufacturer must

 - make sure that the delivered components are suited for his individual application and check the information given in this documentation with regard to the use of the components,
 - make sure that his application complies with the applicable safety regulations and standards and carry out the required measures, modifications and complements.
- Startup of the delivered components is only permitted once it is sure that the machine or installation in which they are installed complies with the national regulations, safety specifications and standards of the application.

- Operation is only permitted if the national EMC regulations for the application are met.
The instructions for installation in accordance with EMC requirements can be found in the documentation "EMC in Drive and Control Systems".
The machine or installation manufacturer is responsible for compliance with the limiting values as prescribed in the national regulations.
- Technical data, connections and operational conditions are specified in the product documentation and must be followed at all times.

3.5 Protection Against Contact with Electrical Parts

Note: This section refers to equipment and drive components with voltages above 50 Volts.

Touching live parts with voltages of 50 Volts and more with bare hands or conductive tools or touching ungrounded housings can be dangerous and cause electric shock. In order to operate electrical equipment, certain parts must unavoidably have dangerous voltages applied to them.

**DANGER****High electrical voltage! Danger to life, severe bodily harm by electric shock!**

- = Only those trained and qualified to work with or on electrical equipment are permitted to operate, maintain or repair this equipment.
- = Follow general construction and safety regulations when working on high voltage installations.
- = Before switching on power the ground wire must be permanently connected to all electrical units according to the connection diagram.
- = Do not operate electrical equipment at any time, even for brief measurements or tests, if the ground wire is not permanently connected to the points of the components provided for this purpose.
- = Before working with electrical parts with voltage higher than 50 V, the equipment must be disconnected from the mains voltage or power supply. Make sure the equipment cannot be switched on again unintended.
- = The following should be observed with electrical drive and filter components:
 - = Wait thirty (30) minutes after switching off power to allow capacitors to discharge before beginning to work. Measure the voltage on the capacitors before beginning to work to make sure that the equipment is safe to touch.
 - = Never touch the electrical connection points of a component while power is turned on.
 - = Install the covers and guards provided with the equipment properly before switching the equipment on. Prevent contact with live parts at any time.
 - = A residual-current-operated protective device (RCD) must not be used on electric drives! Indirect contact must be prevented by other means, for example, by an overcurrent protective device.
 - = Electrical components with exposed live parts and uncovered high voltage terminals must be installed in a protective housing, for example, in a control cabinet.

To be observed with electrical drive and filter components:



DANGER

**High electrical voltage on the housing!
High leakage current! Danger to life, danger of
injury by electric shock!**

- = Connect the electrical equipment, the housings of all electrical units and motors permanently with the safety conductor at the ground points before power is switched on. Look at the connection diagram. This is even necessary for brief tests.
 - = Connect the safety conductor of the electrical equipment always permanently and firmly to the supply mains. Leakage current exceeds 3.5 mA in normal operation.
 - = Use a copper conductor with at least 10 mm² cross section over its entire course for this safety conductor connection!
 - = Prior to startups, even for brief tests, always connect the protective conductor or connect with ground wire. Otherwise, high voltages can occur on the housing that lead to electric shock.
-

3.6 Protection Against Electric Shock by Protective Low Voltage (PELV)

All connections and terminals with voltages between 0 and 50 Volts on Rexroth products are protective low voltages designed in accordance with international standards on electrical safety.



WARNING

**High electrical voltage due to wrong
connections! Danger to life, bodily harm by
electric shock!**

- = Only connect equipment, electrical components and cables of the protective low voltage type (PELV = Protective Extra Low Voltage) to all terminals and clamps with voltages of 0 to 50 Volts.
 - = Only electrical circuits may be connected which are safely isolated against high voltage circuits. Safe isolation is achieved, for example, with an isolating transformer, an opto-electronic coupler or when battery-operated.
-

3.7 Protection Against Dangerous Movements

Dangerous movements can be caused by faulty control of the connected motors. Some common examples are:

- improper or wrong wiring of cable connections
- incorrect operation of the equipment components
- wrong input of parameters before operation
- malfunction of sensors, encoders and monitoring devices
- defective components
- software or firmware errors

Dangerous movements can occur immediately after equipment is switched on or even after an unspecified time of trouble-free operation.

The monitoring in the drive components will normally be sufficient to avoid faulty operation in the connected drives. Regarding personal safety, especially the danger of bodily injury and material damage, this alone cannot be relied upon to ensure complete safety. Until the integrated monitoring functions become effective, it must be assumed in any case that faulty drive movements will occur. The extent of faulty drive movements depends upon the type of control and the state of operation.

**DANGER****Dangerous movements! Danger to life, risk of injury, severe bodily harm or material damage!**

- = Ensure personal safety by means of qualified and tested higher-level monitoring devices or measures integrated in the installation. Unintended machine motion is possible if monitoring devices are disabled, bypassed or not activated.
- = Pay attention to unintended machine motion or other malfunction in any mode of operation.
- = Keep free and clear of the machine's range of motion and moving parts. Possible measures to prevent people from accidentally entering the machine's range of motion:
 - use safety fences
 - use safety guards
 - use protective coverings
 - install light curtains or light barriers
- = Fences and coverings must be strong enough to resist maximum possible momentum, especially if there is a possibility of loose parts flying off.
- = Mount the emergency stop switch in the immediate reach of the operator. Verify that the emergency stop works before startup. Don't operate the machine if the emergency stop is not working.
- = Isolate the drive power connection by means of an emergency stop circuit or use a starting lockout to prevent unintentional start.
- = Make sure that the drives are brought to a safe standstill before accessing or entering the danger zone. Safe standstill can be achieved by switching off the power supply contactor or by safe mechanical locking of moving parts.
- = Secure vertical axes against falling or dropping after switching off the motor power by, for example:
 - mechanically securing the vertical axes
 - adding an external braking/ arrester/ clamping mechanism
 - ensuring sufficient equilibration of the vertical axes

The standard equipment motor brake or an external brake controlled directly by the drive controller are not sufficient to guarantee personal safety!

- = Disconnect electrical power to the equipment using a master switch and secure the switch against reconnection for:
 - maintenance and repair work
 - cleaning of equipment
 - long periods of discontinued equipment use
 - = Prevent the operation of high-frequency, remote control and radio equipment near electronics circuits and supply leads. If the use of such equipment cannot be avoided, verify the system and the installation for possible malfunctions in all possible positions of normal use before initial startup. If necessary, perform a special electromagnetic compatibility (EMC) test on the installation.
-

3.8 Protection Against Magnetic and Electromagnetic Fields During Operation and Mounting

Magnetic and electromagnetic fields generated near current-carrying conductors and permanent magnets in motors represent a serious health hazard to persons with heart pacemakers, metal implants and hearing aids.



WARNING

Health hazard for persons with heart pacemakers, metal implants and hearing aids in proximity to electrical equipment!

- = Persons with heart pacemakers, hearing aids and metal implants are not permitted to enter the following areas:
 - Areas in which electrical equipment and parts are mounted, being operated or started up.
 - Areas in which parts of motors with permanent magnets are being stored, operated, repaired or mounted.
 - = If it is necessary for a person with a heart pacemaker to enter such an area, then a doctor must be consulted prior to doing so. Heart pacemakers that are already implanted or will be implanted in the future, have a considerable variation in their electrical noise immunity. Therefore there are no rules with general validity.
 - = Persons with hearing aids, metal implants or metal pieces must consult a doctor before they enter the areas described above. Otherwise, health hazards will occur.
-

3.9 Protection Against Contact with Hot Parts



CAUTION

Housing surfaces could be extremely hot! Danger of injury! Danger of burns!

- = Do not touch housing surfaces near sources of heat! Danger of burns!
- = After switching the equipment off, wait at least ten (10) minutes to allow it to cool down before touching it.
- = Do not touch hot parts of the equipment, such as housings with integrated heat sinks and resistors. Danger of burns!

3.10 Protection During Handling and Mounting

Under certain conditions, incorrect handling and mounting of parts and components may cause injuries.



CAUTION

Risk of injury by incorrect handling! Bodily harm caused by crushing, shearing, cutting and mechanical shock!

- = Observe general installation and safety instructions with regard to handling and mounting.
- ⇒ Use appropriate mounting and transport equipment.
- ⇒ Take precautions to avoid pinching and crushing.
- = Use only appropriate tools. If specified by the product documentation, special tools must be used.
- ⇒ Use lifting devices and tools correctly and safely.
- = For safe protection wear appropriate protective clothing, e.g. safety glasses, safety shoes and safety gloves.
- ⇒ Never stand under suspended loads.
- = Clean up liquids from the floor immediately to prevent slipping.

3.11 Battery Safety

Batteries contain reactive chemicals in a solid housing. Inappropriate handling may result in injuries or material damage.



CAUTION

Risk of injury by incorrect handling!

- = Do not attempt to reactivate discharged batteries by heating or other methods (danger of explosion and cauterization).
- = Never charge non-chargeable batteries (danger of leakage and explosion).
- ⇒ Never throw batteries into a fire.
- ⇒ Do not dismantle batteries.
- = Do not damage electrical components installed in the equipment.

Note: Be aware of environmental protection and disposal! The batteries contained in the product should be considered as hazardous material for land, air and sea transport in the sense of the legal requirements (danger of explosion). Dispose batteries separately from other waste. Observe the legal requirements in the country of installation.

3.12 Protection Against Pressurized Systems

Certain motors and drive controllers, corresponding to the information in the respective Project Planning Manual, must be provided with pressurized media, such as compressed air, hydraulic oil, cooling fluid and cooling lubricant supplied by external systems. Incorrect handling of the supply and connections of pressurized systems can lead to injuries or accidents. In these cases, improper handling of external supply systems, supply lines or connections can cause injuries or material damage.



CAUTION

Danger of injury by incorrect handling of pressurized systems !

- = Do not attempt to disassemble, to open or to cut a pressurized system (danger of explosion).
- = Observe the operation instructions of the respective manufacturer.
- = Before disassembling pressurized systems, release pressure and drain off the fluid or gas.
- = Use suitable protective clothing (for example safety glasses, safety shoes and safety gloves)
- = Remove any fluid that has leaked out onto the floor immediately.

Note: Environmental protection and disposal! The media used in the operation of the pressurized system equipment may not be environmentally compatible. Media that are damaging the environment must be disposed separately from normal waste. Observe the legal requirements in the country of installation.

Notes

4 CNC Control Modules CMP 40 and CMP 60

4.1 Brief Description

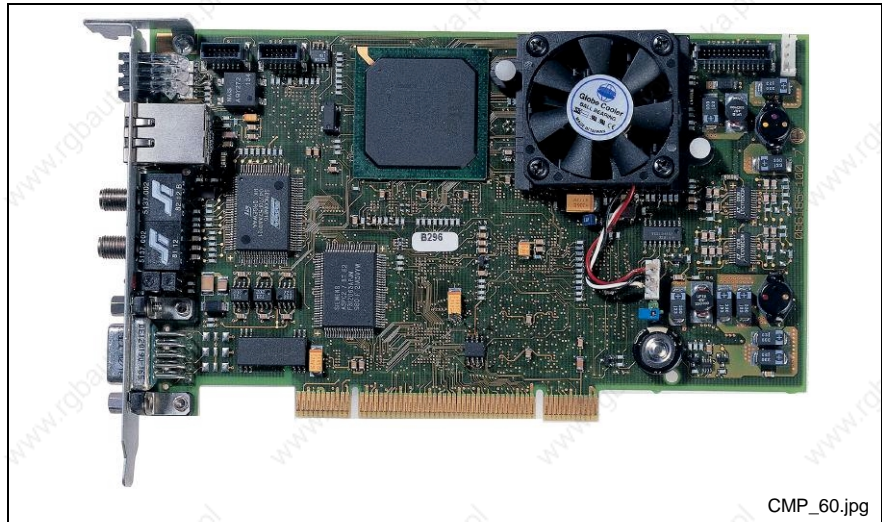

Fig. 4-1: CNC control module CMP 40/60

CNC control module CMP 40 and CMP 60 are the central units in control system MTX. They have CNC and PLC functionalities. They are installed in an unassigned PCI slot, either in industrial PCs from Bosch Rexroth or in foreign PCs. The standard equipment includes interfaces allowing the activation of intelligent drives via SERCOS interface, of I/Os via PROFIBUS-DP and peripheral assemblies via Ethernet. An optional high-speed I/O interface is available for 8 high-speed inputs and outputs.

4.2 Performance Data

Designation	CMP 40	CMP 60
Number of axes	max. 8	max. 64
Spindle therof	max. 2	max. 8
Number of interpolated axes/channel	max. 4	max. 8
Number NC channels	max. 2	max. 12
SERCOS cycle time	min. 6ms (in 8 axes configuration, 4 axis interpolation)	min. 250 μ s (in 8 axes configuration, 4 axis interpolation)
Block cycle time	min. 6ms	min. 250 μ s

Fig. 4-2: Performance data CMP 40/60

4.3 Technical Data

Processor	Celeron 650MHz with 265k byte second level Cache
Memory	SDRAM: 64 Mbyte SRAM: 1 Mbyte...8 MByte
Bus	universal (5V and 3,3V compatible) PCI-Bus Interface
Power supply	5V DC +/- 5%, max. 5A
Power consumption	Typical 21 W

Fig. 4-3: Technical data CMP 40/60

4.4 Handling



CAUTION

If touched, the fan will be destroyed!

⇒ The fan on the CMP 40/60 is highly sensible and must not be touched.

Resistance to Climatic Changes

Temperature

Storage temperature: - 20° C through + 70° C

Operating temperature: + 5° C through + 55° C
(ambient temperature on chart)

Moisture

Climatic category 3K3 according to EN 60721, no moisture condensation allowed.

Corrosion/Chemical Resistance

Ambient air must be free from high concentrations of acids, alkaline solutions, corrosive agents, metal vapors or other conducting contaminants.

Noise Radiation, Immunity (EMC)

Radio Interference Suppression

Radio interference suppression must be ensured in accordance with EN 50081-2.

Immunity

Radio immunity must be ensured in accordance with EN 50082-2. The connections for interface lines must be tested according to Table 3 of this standard (connections for process, measurement and control lines as well as long bus and control lines).

The criteria for operating quality mentioned in this standard are explained in the test plan.

Service Concept

If the CMP 40/60 is defective, the complete module must be replaced. On-site repairs at the CMP 40/60 are not intended. Only the CPU fan of the module can be replaced.

Note: Please consider the necessary precautionary measures during the utilization of electrostatic discharge-endangered modules (EN 61340-5-1; EN 61340-5-2) during replacing the fan or the complete module.

Spare parts

Designation	Type	Material number
CMP 40 complete	CMP40.1-SP-304-FN-NNNN-NW	R911170066
CMP 60 complete	CMP60.1-SP-304-FN-NNNN-NW	R911307078
CPU fan	Fan Celeron P3	1070922532

Fig. 4-4: Spare parts CMP 40/60

4.5 Control and Indicator Components

LEDs and External Watchdog Reset Button

The CMP 60 is provided with three dual LEDs (red and green activation in one LED) as well as one red LED (in the keypad).

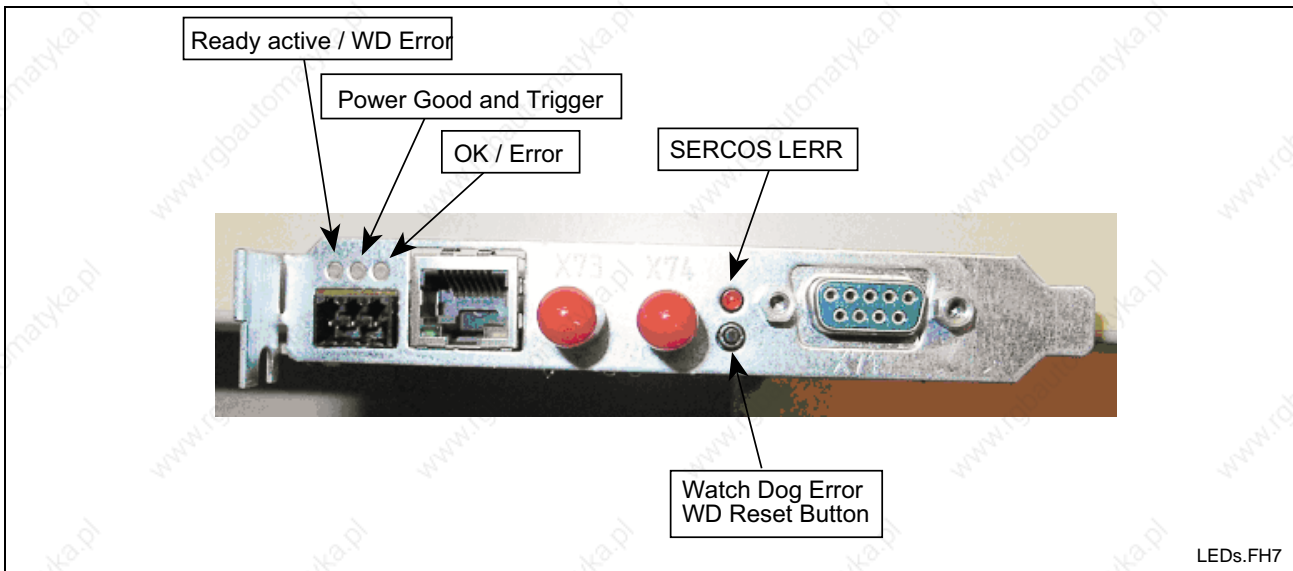

Fig. 4-5: LEDs and external watchdog reset button

Ready active / watchdog error LED

This dual LED indicates the following states:

1. **LED off** (with power good LED being active): watchdog not yet alert, or ready contact opened by the software (the watchdog, however, is still triggered internally).
2. **LED green**: ready contact closed, watchdog triggered.
3. Red LED flashing at high frequency: the local CPU is in the reset state, i.e. has not been started yet.
4. **Red LED emitting steady light**: a ready error has occurred, and the watchdog(s) has/have responded.

Power Good / Trigger LED

This dual LED indicates the following states:

1. **LED off**: the voltage of at least one of the four on-board DC-DC converters is incorrect. => vector group defective, or PC power supply unit too weak or defective.
2. **LED green**: all four voltages are correct.
3. **LED pulsating yellow**: approx. 300 msec trigger pulse for debugging purposes, generated by "cs_trig_led".

OK / error LED

This dual LED can be used by software as desired.

The red LED is automatically activated by the EPLD on power-down. Thereafter, any access to the SRAM is disabled. Usually, this state is not indicated visually, since the voltages are preserved even for less than 1 msec.

SERCOS LERR LED

This red LED is directly activated by the SERCON816 controller (L_ERR#) and allows monitoring of the FO receiving quality to a limited degree. This LED should not be on.

Watchdog Reset Button

If actuated, this button allows resetting of a pending watchdog error and cancelling of any active PC NMI disable signal (see cs_dis_pc signal description). This actuation automatically "alerts" the watchdog logic. In addition, the "watchdog reset button" can be used to switch over to the RAM Boot (reset LED flashing) on power-on and LRESET.

Actuation of this button does not have any further effect on the remaining logic.

4.6 Interfaces

SERCOS interface X7S1, X7S2

The control module CMP 40/60 permits operation of drives that are compatible with a SERCOS interface. The connection to such drives is established by means of FO cables. A ring structure according to SERCOS interface (IEC 1491) is used as the topology.

The SERCOS ring begins and ends at the CMP 40/60 module. The optical output of the control (X7S2) is connected to the optical input of the first drive via an optical fiber. The output of the first drive is connected to the input of the next drive, etc. The output of the last drive is connected to the input of the CMP 40/60 module (X7S1). The maximum transfer rate is 16 Mbauds.

PROFIBUS-DP Master Interface X7P

The control module CMP 40/60 exchanges data with the operator panels (VAM...) and the sensor and actuator level (Inline/Fieldline modules) via the PROFIBUS-DP interface. This is achieved by means of cable assemblies of variable lengths. The maximum transfer rate is 12 Mbauds.

Ethernet Interface

The control module CMP 40/60 exchanges data with the master computer level via an Ethernet interface. The interface is realized by means of an RJ45 connector and allows a maximum transfer rate of 100 Mbauds.

Ready Contact

If the control module CMP 40/60 has not been started up yet or if a watchdog error has occurred during operation, the ready contact opens. For that reason, it is appropriate to connect the contact in the emergency-stop chain of the machine. The maximum contact load is 60 V / 1 A.

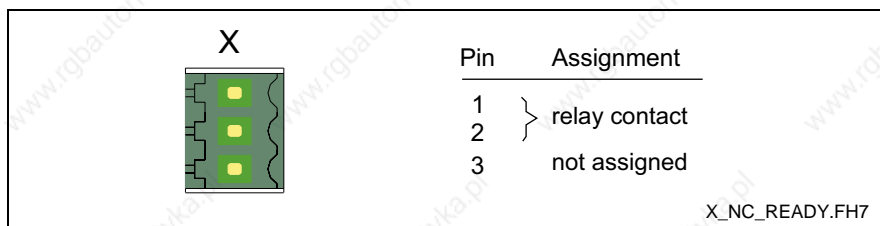

Fig. 4-6: X - connection NC Ready

Note: Improper shielding may cause malfunctions! Only use shielded cables and metallic or conducting connector or coupler housings with large-area shield application.

Optional Highspeed I/O Interface

The highspeed I/O interface is an extension module for the control module CMP 40/60, with 8 highspeed inputs and 8 highspeed outputs. The module is assigned to a slot in the industrial PC, but does not have a PCI bus connection. The connection to the CMP 40/60 is established directly via two ribbon cables.

Note: To permit future retrofitting, the highspeed I/O interface may only be mounted to the right of the CMP 40/60 on the component side (owing to the ribbon cables).

24 V DC Voltage Connection

The inputs and outputs of the highspeed I/O interface are supplied with 24 V DC via a 4-pin clamp-type terminal. Pins 1 and 2 as well as pins 3 and 4 respectively are connected to each other on the printed circuit board. Two LEDs are provided next to the connector. These LEDs emit light once 24 V DC is applied.

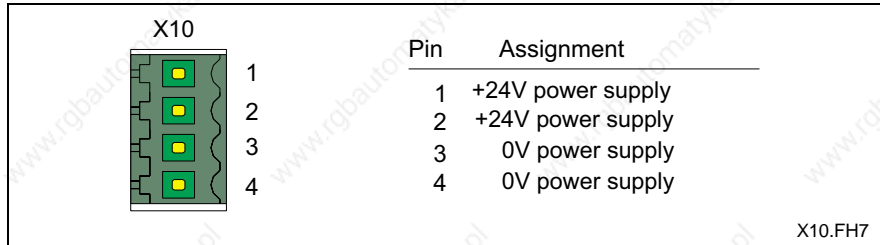

Fig. 4-7: X10 – 24 V DC voltage connection



CAUTION

Dangerous electric voltage!

⇒ The 24V DC input voltage must meet the requirements for “safety separation”.

Digital Outputs

The digital outputs are provided on the 8-pin connector X11. A light-emitting diode, which is lit if high level is applied to the output, is located next to each of the pins of the connector.

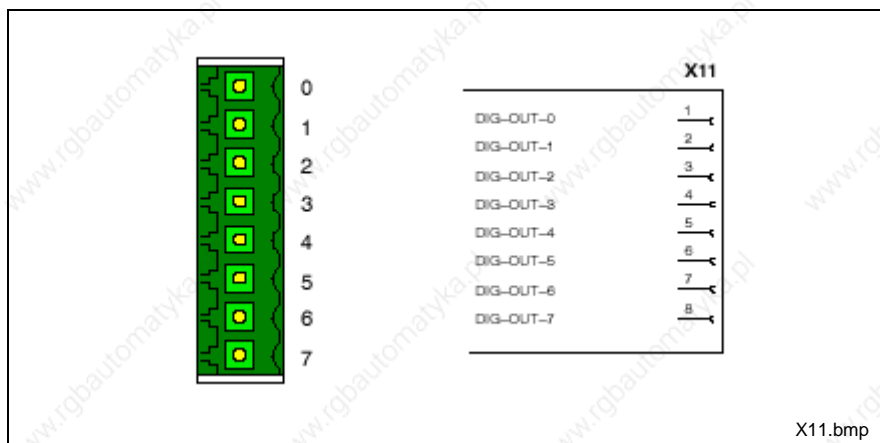

Fig. 4-8: X11 – Digital Out

Technical data of the outputs

Current range in case of 1-signal at 24 V (permanently)	max. 500 mA
Voltage drop at 600 mA	max. 3 V
Leakage current (0-signal) / with VN340SP	max. 2 mA
Short-circuit current with overtemperature	max. 2.5 A
Switching time	max. 300 μs

Fig. 4-9: Working range of digital outputs

Measured switching times in no-load state:

- ON delay 48 μs

- OFF delay 700 μ s

Measured switching times under 0.5 A load:

- ON delay 50 μ s
- OFF delay 135 μ s

Digital Inputs

The digital inputs are provided on the 8-pin connector X12. A light-emitting diode, which is lit if high level is applied to the particular input, is located next to each of the pins of the connector.

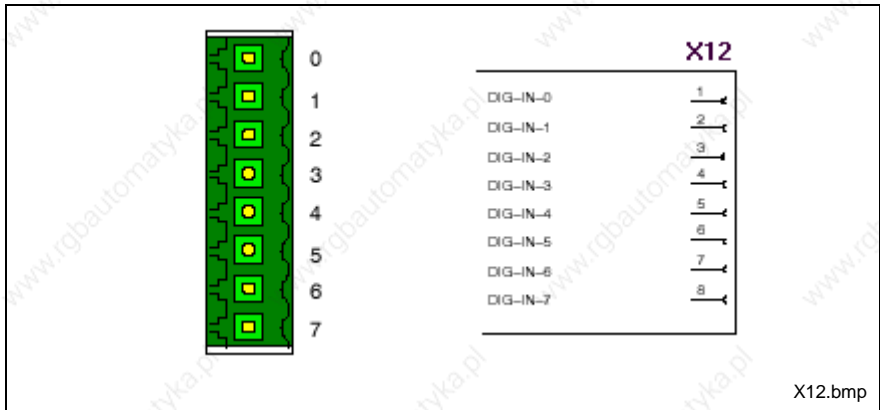

Fig. 4-10: X12 – Digital In

Technical data of the inputs

Limit value	0-state		Transition range		1-state	
	UL/V	IL/mA	UT/V	IT/mA	UH/V	IH/mA
Max.	5	30	11	30	30	30
Min.	-3	ND	5	2	11	5,0

Fig. 4-11: Working range of digital inputs

Switching time: max. 100 μ s

4.7 Order Type

The CNC control modules CMP 40 and CMP 60 are available as subitems of an industrial PC from Bosch Rexroth (VSP, VSB, BTV, VPP, IPC, VPB). The various designs of the industrial PCs are filed in so-called control configurations (CFG-..).

Note: Control module CMP 40 is only allowed to be used in the Bosch Rexroth standard industrial PCs. CMP 60 can be used in all Bosch Rexroth industrial PCs, also in the high-end industrial PCs.

Order Codes in Industrial PCs from Bosch Rexroth

Industrial PC	Control Configuration	Type
VSP 16/40, VSB 40	CFG-VSN01E1-FC-NN-NN-NN-NN-NN	with CMP 40
	CFG-VSN01E1-FC-IC-NN-NN-NN-NN	with CMP 40 and I/O interface for 8 inputs and 8 outputs
	CFG-VSN01E1-EC-NN-NN-NN-NN-NN	with CMP 60
	CFG-VSN01E1-EC-IC-NN-NN-NN-NN	with CMP 60 and I/O interface for 8 inputs and 8 outputs
BTV 16/40, IPC 40	CFG-BTV16.1AN-EC-NN-NN	with CMP 60
	CFG-BTV16.1AN-EC-IC-NN	with CMP 60 and I/O interface for 8 inputs and 8 outputs
VPP 16/40, VPB 40	CFG-VPN01A1-EC-NN-NN	with CMP 60
	CFG-VPN01A1-EC-IC-NN	with CMP 60 and I/O interface for 8 inputs and 8 outputs

Fig. 4-12: Control configurations with CMP 40 and CMP 60

The control configuration (CFG-..) contains the control module CMP 40 or CMP 60 and all accessories required for installation of an industrial PC from Bosch Rexroth.

4.8 Documentation

Documentation providing a detailed description of the CNC control module CMP 40/60 is available.

5 Standard Industrial PC VSP

5.1 Brief Description



Fig. 5-1: VSP 16.1 with 12" color display



Fig. 5-2: VSP 40.1 with 15" color display

Standard industrial PCs VSP are PC-based control and visualization systems for normal ambient conditions with tested capability for industrial environments. These PCs are mainly installed in an operator console or in a switch cabinet wall. By installation of a CNC control module CMP 40 or CMP 60 in the attached PC box, the operator panels fulfill control functions.

5.2 Field of Application

The control and visualization terminals are used in industrial environments with normal vibration and shock requirements.

5.3 Technical Data

	VSP 16.1	VSP 40.1
Display	12" color display	15" color display
Front panel design	16 machine function keys	
PC box	6 slots (PCI)	
Processor	Celeron, 2 GHz	
RAM	512 MB RAM	
Line voltage	115..230 V AC or 24 V DC	

Fig. 5-3: Technical data of VSP 16/40

5.4 Types

The following types of the standard industrial PC VSP 16/40 are available:

Type	Comment
VSP16.1BKE-512NN-C1C-AN-NN-FW	Line voltage 115..230 V AC; without CD-ROM drive
VSP16.1BKE-512NN-C1C-AD-NN-FW	Line voltage 115..230 V AC; with CD-ROM drive
VSP40.1BIE-512NN-C1C-AN-NN-FW	Line voltage 115..230 V AC; without CD-ROM drive
VSP40.1BIE-512NN-C1C-AD-NN-FW	Line voltage 115..230 V AC; with CD-ROM drive
VSP40.1BIE-512NN-C1D-AN-NN-FW	Line voltage 24 V DC; without CD-ROM drive

Fig. 5-4: VSP 16/40 order types

5.5 Control Configuration

If the standard industrial PC VSP 16/40 is equipped with a control module CMP 40 or CMP 60, the following control configurations (CFG..) are available:

Type	Comment
CFG-VSN01E1-FC-NN-NN-NN-NN-NN	with control module CMP 40
CFG-VSN01E1-FC-IC-NN-NN-NN-NN-NN	with control module CMP 40 and I/O interface for 8 inputs and 8 outputs
CFG-VSN01E1-EC-NN-NN-NN-NN-NN-NN	with control module CMP 60
CFG-VSN01E1-EC-IC-NN-NN-NN-NN-NN	with control module CMP 60 and I/O interface for 8 inputs and 8 outputs

Fig. 5-5: Control configuration for VSP 16/40

5.6 Accessories

Connectors and Cable Assemblies

Type	Comment
B-AC STECKER NETZ 230V	230 V power plug, angular flange socket
BKS-U-N-NTZKAB-IPCRHO-002,5-P	230 V power cord with female flange socket, angular, cable length 2.5 m

Fig. 5-6: Connectors and cables

5.7 Documentation

The following documentation provides a detailed description of the VSP 16/40 operator panels:

DOK-SUPPL*-VSP*16/40**-PRxx-EN-P

6 Standard Industrial PC VSB with Operator Panel VDP

6.1 Brief Description



Fig. 6-1: Standard industrial PC VSB 40.1 with operator panel VDP 16.1

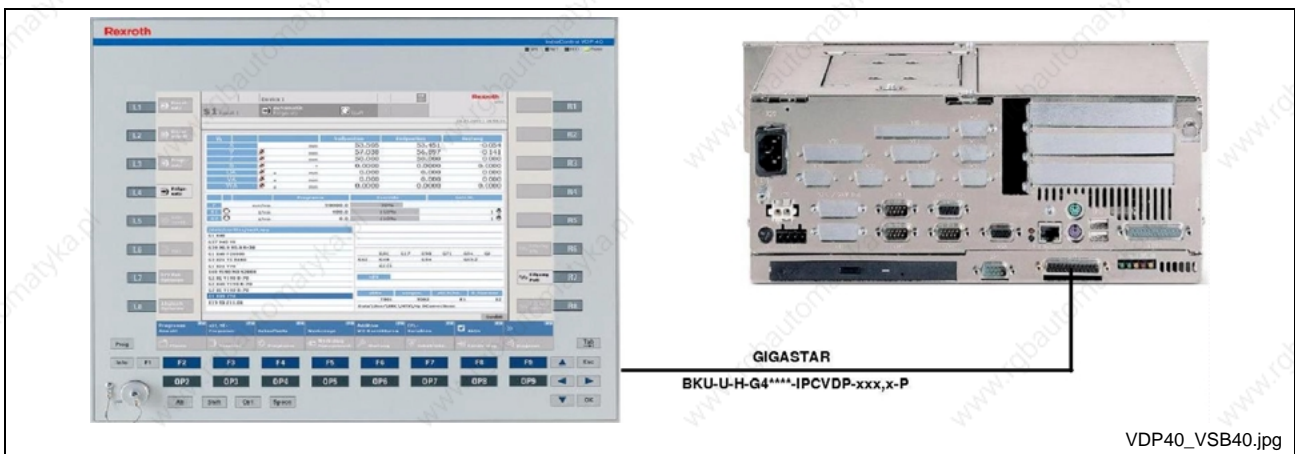

Fig. 6-2: Standard industrial PC VSB 40.1 with operator panel VDP 40.1

The VSB 40.1 is an industrial PC which, in connection with the passive operator panels VDP 16.1 or VDP 40.1, represents a PC-based control and visualization terminal with normal capability for industrial environments. The VSP 40.1 is intended to be installed in a switch cabinet. The operator panels VDP 16.1 and VDP 40.1 are designed to be installed in an operator console or in a switch cabinet wall. The connection between VDP and VSP is established via a GIGASTAR interface. If equipped with a CNC control module CMP 40 or CMP 60, the VSB 40.1 fulfills PC control functions.

6.2 Field of Application

The standard industrial PCs are used in industrial environments with normal vibration and shock requirements.

6.3 Technical Data

VSB 40.1

PC box	6 slots (PCI)
Processor	Celeron, 2 GHz
RAM	512 MB RAM
Line voltage	115..230 V AC or 24 V DC

Fig. 6-3: Technical data of VSB 40.1

VDP 16/40

	VDP 16.1	VDP 40.1
Display	12" color display	15" color display
Front panel design	16 machine function keys	
Line voltage	via GIGASTAR interface (24 V DC)	

Fig. 6-4: Technical data of VDP 16/40

6.4 Types

The following types of the standard industrial PC VSB 40 are available:

Type	Remarks
VSB40.1G4E-512NN-C1C-AN-NN	Line voltage 115..230 V AC; without CD-ROM drive
VSB40.1G4E-512NN-C1C-AD-NN	Line voltage 115..230 V AC; with CD-ROM drive

Fig. 6-5: VSB 40.1 types

The following types of the operator panel VDP 16/40 are available:

Type	Remarks
VDP16.1BKN-G4-PS-NN	Operator panel with 12" color display
VDP40.1BIN-G4-PS-NN	Operator panel with 15" color display
VDP40.2DFN-G4-PS-NN	Operator panel with 15" color display with touch-screen

Fig. 6-6: VDP 16/40 types

6.5 Control Configuration

If the standard industrial PC VSB 40 is equipped with a control module CMP 40 or CMP 60, the following control configurations (CFG..) are available:

Type	Remarks
CFG-VSN01E1-FC-NN-NN-NN-NN-NN	with control module CMP 40
CFG-VSN01E1-FC-IC-NN-NN-NN-NN	with control module CMP 40 and I/O interface for 8 inputs and 8 outputs
CFG-VSN01E1-EC-NN-NN-NN-NN-NN	with control module CMP 60
CFG-VSN01E1-EC-IC-NN-NN-NN-NN	with control module CMP 60 and I/O interface for 8 inputs and 8 outputs

Fig. 6-7: Control configurations for VSB 40.1

6.6 Accessories

Connection Cables (GIGASTAR Interface)

The following cable assemblies are available for establishing the connection between the industrial PC VSB 40 and the operator VDP 16/40:

Type	Remarks
BKS-U-H-G4****-IPCVDP-001,0-P	VSB-VDP connection cable, highly flexible, 1 m
BKS-U-H-G4****-IPCVDP-005,0-P	VSB-VDP connection cable, highly flexible, 5 m
BKS-U-H-G4****-IPCVDP-010,0-P	VSB-VDP connection cable, highly flexible, 10 m
BKS-U-N-G4****-IPCVDP-020,0-P	VSB-VDP connection cable, flexible, 20 m
BKS-U-H-G4****-IPCVDP-030,0-P	VSB-VDP connection cable, highly flexible, 30 m

Fig. 6-8: Connection Cables

Fastening Angles

To mount the industrial PC VSB 40 vertically, the following angles are available:

Type	Comment
WINKEL PCBOX-IPC	Angle for VSB 40

Fig. 6-9: Fastening angles

6.7 Documentation

The following documentation providing a detailed description of the standard industrial PC VSB 40 is available:

DOK-SUPPL *-VSB*40.1***-PRxx-EN-P

The following documentation provides a detailed description of the VDP 16/40 operator panels:

DOK-SUPPL *-VDP16/40/60-PRxx-EN-P

7 High-End Industrial PC BTV / VPP

7.1 Brief Description

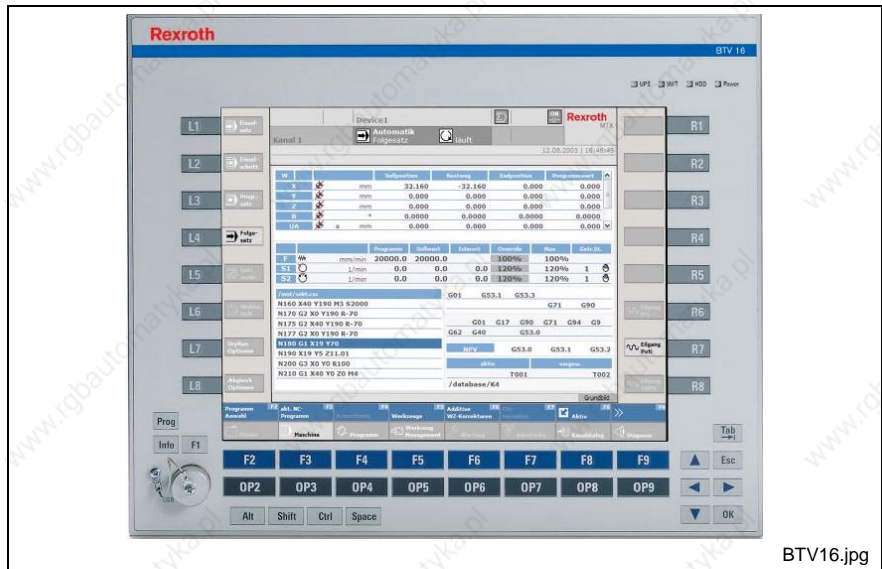

Fig. 7-1: High-end industrial PC BTV 16.2 / VPP 16.1 with 12" color display



Fig. 7-2: High-end industrial PC BTV 40.2 / VPP 40.1 with 15" color display

The operator panels BTV 16/40 and VPP 16/40 are active PC-based control and visualization terminals with high capability for industrial environments. These PCs are mainly installed in an operator console or in a switch cabinet wall. By installation of a CNC control module CMP 60 in the attached PC box, the operator panels fulfill control functions.

7.2 Field of Application

The high-end industrial PCs are used in industrial environments with increased vibration and shock requirements.

7.3 Technical Data

	BTV 16.2	BTV 40.2	VPP 16.1	VPP 40.1
Display	12" color display	15" color display	12" color display	15" color display
Front panel design	16 machine function keys			
PC box	3 slots (2 x PCI, 1 x PCI/ISA)			
Processor	Pentium III, 933 MHz		Celeron M, min. 1,3GHz	
RAM	512 MB RAM			
Line voltage	115..230 V AC or 24 V DC			

Fig. 7-3: Technical data BTV 16/40 and VPP 16/40

7.4 Types

The following types of the high-end industrial PC BTV 16/40 and VPP 16/40 are available:

Type	Remarks
BTV16.2BKA-512P-P8C-NN-FW	Line voltage 115..230 V AC; without CD-ROM drive
VPP16.1BKA-512NN-M1C-BN-NN-FW	Line voltage 115..230 V AC; without CD-ROM drive
BTV40.2BIA-512P-P8C-NN-FW	Line voltage 115..230 V AC; without CD-ROM drive
BTV40.2BIA-512P-P8D-NN-FW	Line voltage 24 V DC; without CD-ROM drive
VPP40.1BIA-512NN-M1C-BN-NN-FW	Line voltage 115..230 V AC; without CD-ROM drive

Fig. 7-4: BTV 16/40 and VPP 16/40 versions

7.5 Control Configuration

If the high-end industrial PC BTV 16/40 and VPP 16/40 is equipped with a control module CMP 60, the following control configurations (CFG..) are available:

Device	Type	Remarks
BTV 16/40	CFG-BTV16.1AN-EC-NN-NN	with control module CMP 60
	CFG-BTV16.1AN-EC-IC-NN	with control module CMP 60 and I/O interface for 8 inputs and 8 outputs
VPP 16/40	CFG-VPN01A1-EC-NN-NN	with control module CMP 60
	CFG-VPN01A1-EC-IC-NN	with control module CMP 60 and I/O interface for 8 inputs and 8 outputs

Fig. 7-5: Controller configurations for BTV 16/40 and VPP 16/40

7.6 Accessories

Connectors and Cable Assemblies

Type	Remarks
B-AC STECKER NETZ 230V	230 V power plug, angular flange socket
BKS-U-N-NTZKAB-IPCRHO-002,5-P	230 V power cord with female flange socket, angular, cable length 2.5 m

Fig. 7-6: Connectors and cables

7.7 Documentation

The following documentation provides a detailed description of the BTV 16/40 and VPP 16/40 high-end industrial PCs:

DOK-SUPPL*-BTV16/40/60-PRxx-EN-P

DOK-SUPPL*-VPP*XX.1***-PRxx-EN-P

8 High-End Industrial PC IPC 40 and VPB 40 with Operator Panel VDP

8.1 General Information

IPC 40.2 and VPB 40.1 are high-end industrial PCs which, in connection with the passive operator panels VDP 16 or VDP 40, represent a PC-based control and visualization terminal with normal capability for industrial environments. The IPC 40 and VPB 40 are intended to be installed in a switch cabinet. The operator panels VDP 16 and VDP 40 are designed to be installed in an operator console or in a switch cabinet wall. The connection between VDP and IPC or VPB is established via a GIGASTAR interface. If equipped with a CNC control module CMP 60, the IPC 40.2 and VPB 40.1 fulfill PC control functions.

8.2 Types



Fig. 8-1: High-end industrial PC IPC 40.2/VPB 40.1 with operator panel VDP 16.x



Fig. 8-2: High-end industrial PC IPC 40.2/VPB 40.1 with operator panel VDP 40.x

8.3 Field of Application

The high-end industrial PCs are used in industrial environments with increased vibration and shock requirements.

8.4 Technical Data

IPC 40.2 and VPB 40.1

	IPC 40.2	VPB 40.1
PC box	3 slots (2 x PCI, 1 x PCI/ISA)	
Processor	Pentium III, 933 MHz	Celeron M, min. 1,3 GHz
RAM	512 MB RAM	
Line voltage	115..230 V AC or 24 V DC	

Fig. 8-3: Technical data IPC 40.2 and VPB 40.1

VDP 16/40

	VDP 16.x	VDP 40.x
Display	12" color display	15" color display
Front panel design	16 machine function keys	
Line voltage	via GIGASTAR interface (24 V DC)	

Fig. 8-4: Technical data of VDP 16/40

8.5 Types

The following types of the high-end industrial PC IPC 40.2 and VPB 40.1 are available:

Type	Remarks
IPC40.2G4A-512N-P8C-ND-NN-FW	Line voltage 115..230 V AC; with CD-ROM drive
IPC40.2G4A-512N-P8D-ND-NN-FW	Line voltage 24 V DC; with CD-ROM drive
VPB40.1G4A-512NN-M1C-BD-NN-FW	Line voltage 115..230 V AC; with DVD-ROM drive
VPB40.1G4A-512NN-M1D-BD-NN-FW	Line voltage 24 V DC; with DVD-ROM drive

Fig. 8-5: Selection IPC 40.2 and VPB 40.1

The following types of the operator panel VDP 16/40 are available:

Type	Remarks
VDP16.1BKN-G4-PS-NN	Operator panel with 12" color display (utilization in connection with IPC 40.2)
VDP40.1BIN-G4-PS-NN	Operator panel with 15" color display (utilization in connection with IPC 40.2)
VDP16.2BKN-G4-PS-NN	Operator panel with 12" color display (utilization in connection with VPB 40.1)
VDP40.2BIN-G4-PS-NN	Operator panel with 15" color display (utilization in connection with VPB 40.1)
VDP40.2DFN-G4-PS-NN	Operator panel with 15" color display with touch-screen (utilization in connection with VPB 40.1)

Fig. 8-6: VDP 16/40 types

8.6 Control Configurations

If the high-end industrial PCs IPC 40 and VPB 40 are equipped with a control module CMP 60, the following control configurations (CFG..) are available:

Device	Type	Remarks
IPC 40.2	CFG-BTV16.1AN-EC-NN-NN	with control module CMP 60
	CFG-BTV16.1AN-EC-IC-NN	with control module CMP 60 and I/O interface for 8 inputs and 8 outputs
VPB 40.1	CFG-VPN01A1-EC-NN-NN	with control module CMP 60
	CFG-VPN01A1-EC-IC-NN	with control module CMP 60 and I/O interface for 8 inputs and 8 outputs

Fig. 8-7: Controller configuration for IPC 40.2 and VPB 40.1

8.7 Accessories

Connection Cables (GIGASTAR Interface)

The following cable assemblies are available for establishing the connection between the industrial IPC 40 / VPB 40 and the operator panel VDP 16/40:

Type	Remarks
BKS-U-H-G4****-IPCVDP-001,0-P	IPC-VDP connection cable, highly flexible, 1 m
BKS-U-H-G4****-IPCVDP-005,0-P	IPC-VDP connection cable, highly flexible, 5 m
BKS-U-H-G4****-IPCVDP-010,0-P	IPC-VDP connection cable, highly flexible, 10 m
BKS-U-N-G4****-IPCVDP-020,0-P	IPC-VDP connection cable, flexible, 20 m
BKS-U-H-G4****-IPCVDP-030,0-P	IPC-VDP connection cable, highly flexible, 30 m

Fig. 8-8: Connection Cables

Fastening Angles

To mount the industrial PCs IPC 40 and VPB 40 vertically, the following fastening angle is available:

Type	Comment
WINKEL PCBOX-IPC	Angle for IPC 40 / VPB 40

Fig. 8-9: Fastening angles

8.8 Documentation

The following documentations provide a detailed description of the high-end industrial PC IPC 40.2 and the operator panels BTV 16/40:

DOK-SUPPL*-IPC*40.2***-PRxx-EN-P
 DOK-SUPPL*-VPB*40.1***-PRxx-EN-P
 DOK-SUPPL*-VDP16/40/60-PRxx-EN-P

9 Uninterruptible Power System UPS

9.1 Brief Description

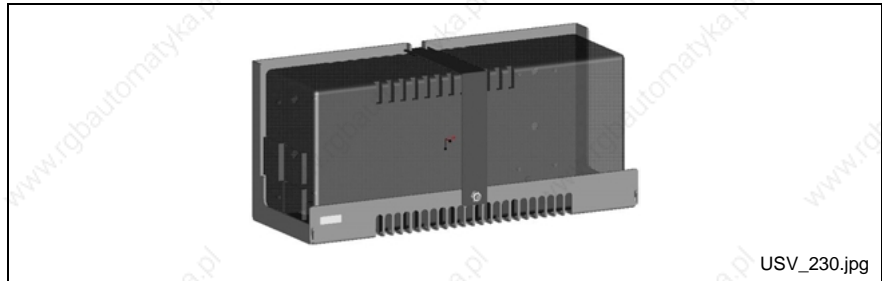

Fig. 9-1: Uninterrupted power supply

The uninterruptible power system UPS is able to override brief voltage dips. In case of longer voltage dips, it initiates and facilitates proper powering down of the operating system. For that reason, we recommend to always install a UPS in order to avoid data losses.

The UPS is connected to the voltage supply line and communicates with the standard industrial PC via the serial interface COM1.

9.2 Type

The uninterruptible power system is available under the following type code:

Type	Comment
VAU01.1S-230-230-255-NN	UPS for 230 V AC

Fig. 9-2: UPS order type

9.3 Accessories

Holder

Available accessories include a holder for mounting the UPS. It can be engaged in a top-hat rail or can be fastened to a mounting plate of a switch cabinet with two M6 screws.

Type	Comment
SUP-M01-VAU01.1S-230	UPS holder

Fig. 9-3: UPS order type

9.4 Documentation

The projecting instructions DOK-SUPPL*-VSP*16/40**-PRxx-EN-P provide a detailed description of how to use the UPS.

10 External Battery Pack

10.1 Brief Description



Fig. 10-1: External battery pack

To prevent data from being lost in case of a power failure, a battery pack for installation in a switch cabinet is available for high-end industrial PCs. The battery pack is connected to the industrial PC by means of the connection cable IKL0264.

10.2 Type

The battery pack is available under the following type code:

Type	Comment
SUP-E01-BTV16/40	Battery pack

Fig. 10-2: Battery pack order type

10.3 Accessories

Connection Cables

The following cable assemblies are available for establishing the connection between the industrial PC and the battery pack:

Type	Comment
IKL0264/001,0	Connection cable, 1.0 m long
IKL0264/003,0	Connection cable, 3.0 m long

Fig. 10-3: Order types of connection cables

10.4 Documentation

The projecting instructions DOK-SUPPL*-BTV16/4060-PRxx-EN-P provide a detailed description of how to use the battery pack.

11 Machine Control Panel VAM

11.1 Brief Description



VAM10.jpg

Fig. 11-1: Machine control panel VAM 10



VAM40.jpg

Fig. 11-2: Machine control panel VAM 40



VAM11.jpg

Fig. 11-3: Machine control panel VAM 11



VAM41.jpg

Fig. 11-4: Machine control panel VAM 41

The machine control panels VAM 10, VAM 40, VAM 11 and VAM 41 permit selection of operating modes as well as manual operation of the machine. They contain the necessary control elements, such as keys with LED indicators, rotary switches for feed and spindle override, E-STOP pushbuttons, key switches, and machine buttons. In their function and design, they are matching the operator panels VSP, VDP, BTV and VPP in an optimum manner. On their rear, the panels are provided with a connector for connecting a handwheel and a manual operator panel as well as connectors for 16 digital 24 V inputs and 8 digital 24 V outputs. Communication with the master control is achieved via PROFIBUS-DP.

11.2 Types

The machine control panels VAM 10/40 will be primarily used in the CNC operation. The following versions are available:

Type	Comment
VAM10.1-PB-NA-TA-TA-VB-1608-NN	Suitable for VSP 16, VDP 16, BTV 16, VPP 16
VAM40.1-PB-NA-TA-TA-VB-MA-1608-NN	Suitable for VSP 40, VDP 40, BTV 40, VPP 40

Fig. 11-5: VAM 10/40 types

The machine control panels VAM 11/41 will be primarily used for the automated production area. The following versions are available:

Type	Comment
VAM11.1-PB-NA-NN-TA-VB-1608-NN	Suitable for VSP 16, VDP 16, BTV 16, VPP 16
VAM41.1-PB-NA-NN-TA-VB-BA-1608-NN	Suitable for VSP 40, VDP 40, BTV 40, VPP 40

Fig. 11-6: VAM 11/41 types

11.3 Accessories

Connection Cables (PROFIBUS Interface)

The machine control panels VAM exchange data with the control module CMP 60 via PROFIBUS-DP. The following cable assemblies are available:

Type	Comment
IKB0033/000,0	Connection between CMP 60 and VAM; cables ready-made at either end; variable length
IKB0034/000,0	Connection between VAM and further Profibus users; cable ready-made at one end; variable length

Fig. 11-7: PROFIBUS connection cables

11.4 Documentation

The following documentation provides a detailed description of the machine control panels VAM:

DOK-SUPPL*-VAM*10/40**-PRxx-EN-P

DOK-SUPPL*-VAM*11/41**-PRxx-EN-P

12 PC Keyboards VAK and PCK

12.1 General Information

Slide-out or built-in keyboards with touch panels are available for operation of the industrial PCs as required.

12.2 Slide-Out Keyboards



Fig. 12-1: Slide-out keyboard VAK 10.1



Fig. 12-2: Slide-out keyboard VAK 40

The slide-out keyboards VAK 10.1 and VAK 40.1 are AT-compatible PS/2 keyboards with 86 keys and integrated mouse pointer. The two keyboards differ only in the different width of their front panels. In their function and design, they are matching the operator panels of the VSP, VDP and VPP series in an optimum manner. The integrated mouse with its mouse buttons permits easy navigation within the graphical user interfaces. The drawer is provided with slide rails and a ball-type snap lock.

12.3 Built-In Keyboards



VAK11.jpg

Fig. 12-3: Built-in keyboard VAK 11.2



VAK41.jpg

Fig. 12-4: Built-in keyboard VAK 41.2

The built-in keyboards VAK 11 and VAK 41 are AT-compatible PS/2 touch panels with 106 keys. The two keyboards differ only in the different width of their front panels. In their function and design, they are matching the operator panels of the VSP, VDP and VPP series in an optimum manner and are characterized by a particularly low installation depth.

12.4 Types

The following types of keyboards for industrial PCs are available:

Design	Type	Remarks
Slide-out keyboard	VAK10.1E-EN-P-MPNN	Matching with VSP 16, VDP 16, VPP 16
	VAK40.1E-EN-P-MPNN	Matching with VSP 40, VDP 40, VPP 40
	VAK40.1E-DE-P-MPNN	Matching with VSP 40, VDP 40, VPP 40
Built-in keyboard (with touch panel)	VAK11.2F-EN-P-NNNN	Matching with VSP 16, VDP 16, VPP 16
	VAK41.2F-EN-P-NNNN	Matching with VSP 40, VDP 40, VPP 40

Fig. 12-5: VAK 10/11/40/41

12.5 Documentation

The following documentation providing a detailed description of the VAK 11/41 built-in keyboards is available:

DOK-SUPPL*-VAK*11/41**-PRxx-EN-P

The following documentation providing a detailed description of the VAK 10/40 slide-out keyboards is available:

DOK-SUPPL*-VAK*40.1***-PRxx-EN-P

13 RECO Inline Modules

13.1 Brief Description

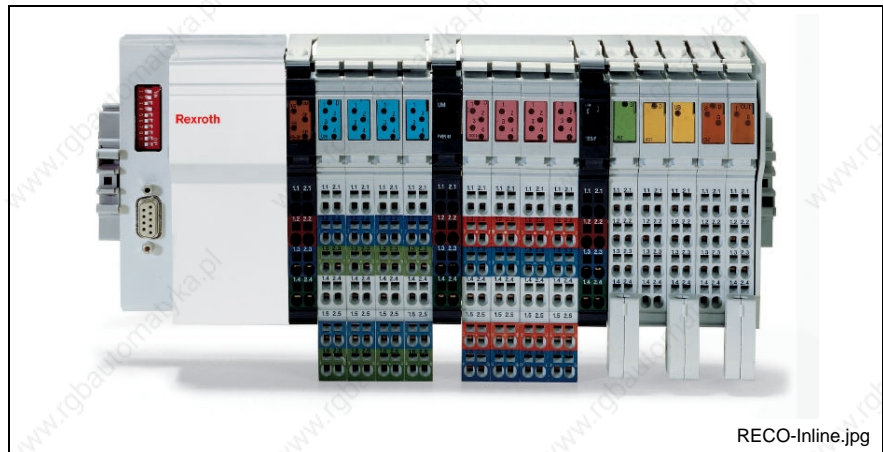

Fig. 13-1: RECO Inline system

The RECO Inline system is a flexible I/O system, which is designed to be mounted to a top-hat rail in a switch cabinet. It is a modular system, i.e. it can be adjusted to the particular application concerned. Communication with the master control is achieved via PROFIBUS-DP.

13.2 Components

The RECO Inline system comprises the following components:

- Field-bus coupling modules
- Feed modules
- 24 V input modules
- 24 V output modules
- Relay for output modules
- Analog modules
- Counter modules
- Accessories

13.3 Documentation

The following documentations provide a detailed description of the RECO Inline system:

- DOK-CONTRL-R-IL*PBSSYS-AWxx-EN-P (application description)
- DOK-CONTRL-R-IL*PB*-BK-FKxx-EN-P (PROFIBUS-DP terminal and module supply)
- DOK-CONTRL-R-IL*DIO***-FKxx-EN-P (digital input and output terminals)

14 Small Control Panel VCP

14.1 Brief Description

The small control panels VCP are control and visualization terminals to operate and observe machines. The devices can be used for different purposes because of the compact design. The communication to the higher-level control is executed via PROFIBUS interface.



Fig. 14-1: Small Control Panel VCP 02.1



Fig. 14-2: Small Control Panel VCP 05.1



Fig. 14-3: Small Control Panel VCP 08.1

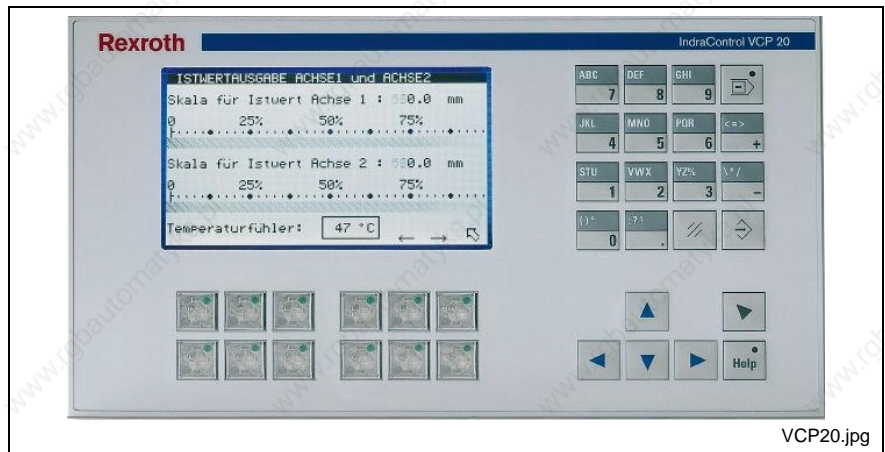

Fig. 14-4: Small Control Panel VCP 20.1



Fig. 14-5: Small Control Panel VCP 25.1

14.2 Technical Data

	VCP 02.1	VCP 05.1	VCP 08.1	VCP 20.1	VCP 25.1
Display	Text terminal with 4 x 20 characters		Graphics terminal with 4 x 20 characters	Graphics terminal with 16 x 40 / 8 x 20 characters	Touch terminal 5,7"
Front plate (H x W)	100 x 148 mm	168 x 120 mm	159 x 209 mm	160 x 300 mm	180 x 234 mm
Keys	4 function, 7 system keys	8 function, 22 system keys	14 function, 22 system keys	12 function, 22 system keys	Touch
Interface	PROFIBUS-DP				
Processor	Z84; 10 MHz				32-bit RISC CPU; 74 MHz
Application memory	256 kByte Flash			256 / 768 kByte Flash	3 MByte Flash
RAM memory	128 kByte static CMOS-RAM				512 kByte static CMOS-RAM
Line voltage	24 V DC; 0,3 A			24 V DC; 0,7 A	24 V DC; 0,4 A

Fig. 14-6: Technical data small control panel VCP

14.3 Types

The following types of the small control panels VCP are available:

Type	Bemerkung
VCP02.1BRN-PB-NN-PW	
VCP05.1BSN-PB-NN-PW	
VCP08.1BTN-PB-NN-PW	
VCP20.1BUN-256PB-NN-PW	256 kByte RAM
VCP20.1BRN-768PB-NN-PW	768 kByte RAM
VCP25.1BRN-003PB-NN-PW	

Fig. 14-7: Selection VCP

14.4 Accessories

Connection Cables (PROFIBUS Interface)

The small control panels VCP exchange data with the control module CMP 60 via PROFIBUS-DP. The following cable assemblies are available:

Type	Bemerkung
IKB0034/000,0	Connection between CMP / VAM and VCP; cables ready-made at one end; variable length
IKB0049/000,0	Connection between VCP and Rexroth Fieldline modules; ready-made at one end, M12 socket; variable length

Fig. 14-8: PROFIBUS connection cables

14.5 Documentation

The following documentations provide a detailed description of the small control panels VCP:

- DOK-SUPPL*-VCP02*****-PRxx-EN-P
- DOK-SUPPL*-VCP05*****-PRxx-EN-P
- DOK-SUPPL*-VCP08*****-PRxx-EN-P
- DOK-SUPPL*-VCP20*****-PRxx-EN-P
- DOK-SUPPL*-VCP25*****-PRxx-EN-P

15 RECO Fieldline Modules

15.1 Brief Description



Fig. 15-1: RECO Fieldline modules

The input and output modules of the RECO Fieldline product family are designed for decentralized automation tasks under adverse ambient conditions. The modules comply with protection degree IP65 / IP67. They permit direct connection of sensors and actuators in an environment near the station. Communication with the master control is achieved via PROFIBUS-DP.

15.2 Components

Three types of RECO Fieldline modules are available:

Type	Description
RF-FLS PB M12 DI8 M12	8 24V inputs
RF-FLS PB M12 DIO 4/4 M12-2A	4 24V inputs; 4 24V/2A outputs
RF-FLS PB M12 DO 8 M12-2A	8 24V/2A outputs

Fig. 15-2: Module types

15.3 Documentation

The following documentation provides a detailed description of the RECO Fieldline system:

DOK-CONTRL-RF-FLS-PB**-PRxx-EN-P

16 Applications

16.1 Standard Industrial PC VSP 16.1

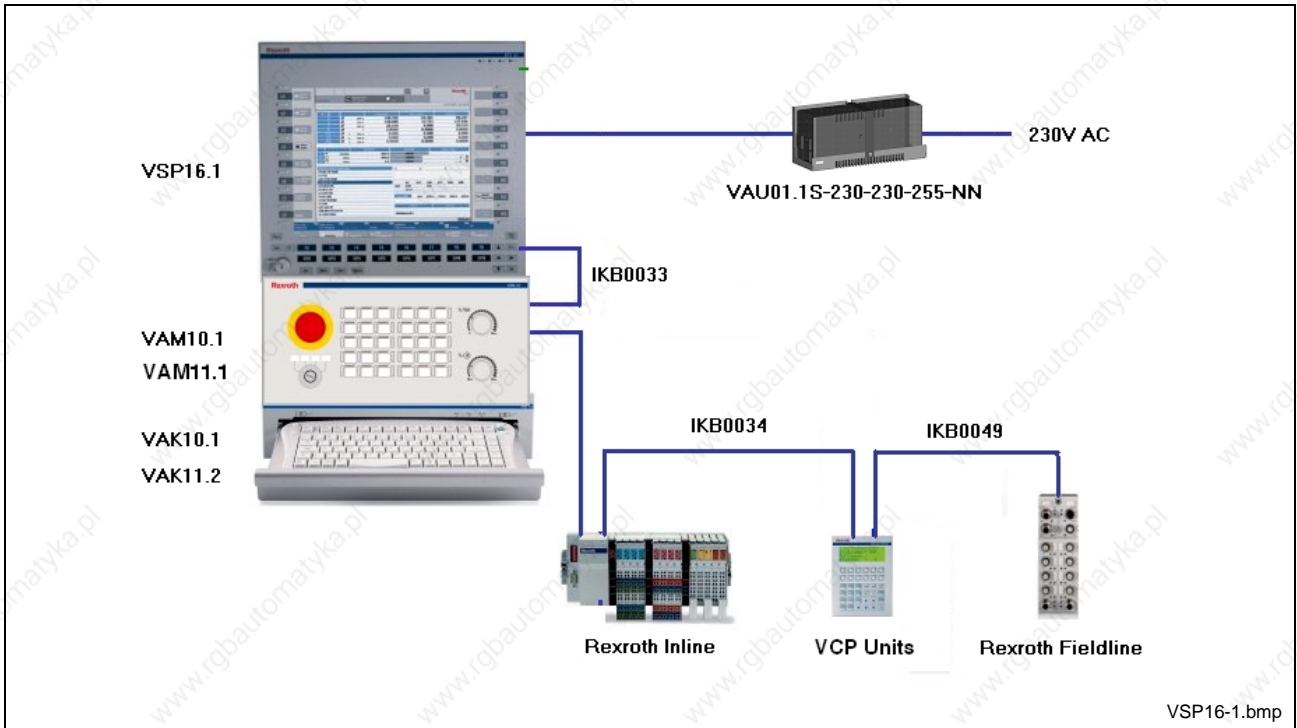

Fig. 16-1: VSP 16.1

16.2 Standard Industrial PC VSP 40.1

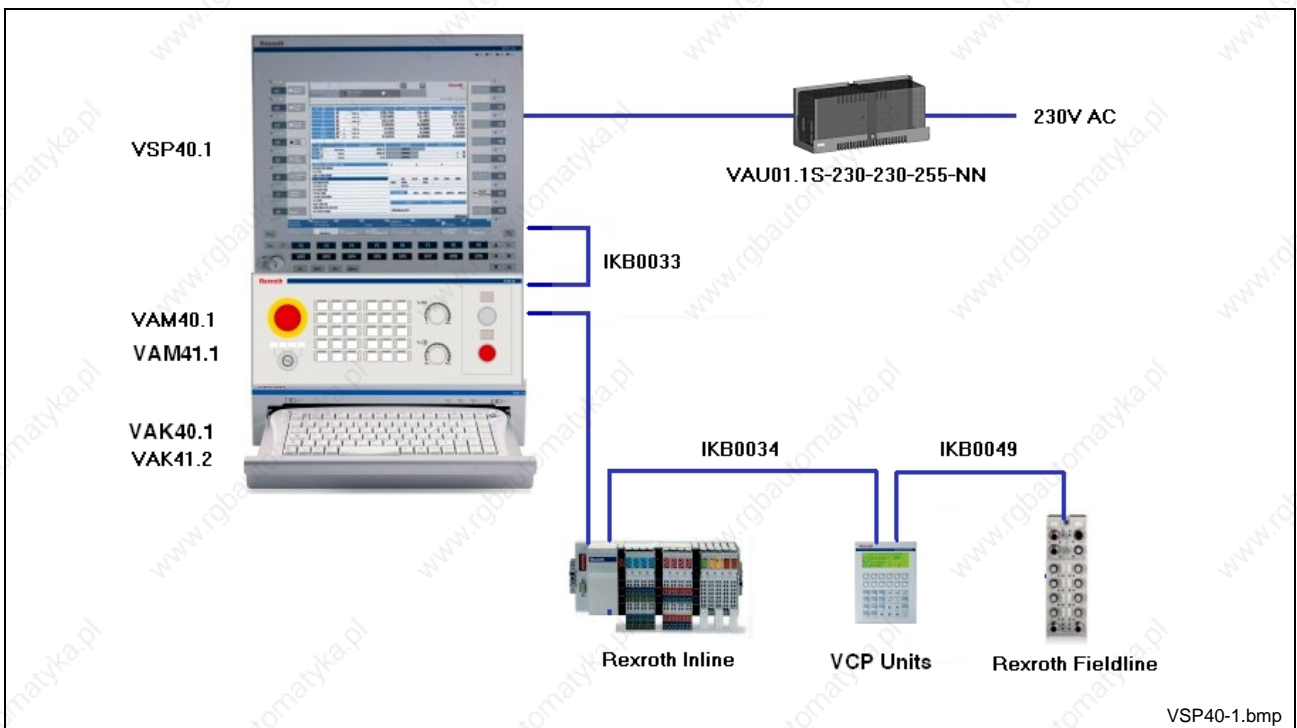

Fig. 16-2: VSP 40.1

16.3 Standard Industrial PC VSB 40.1 with Operator Panel VDP 16

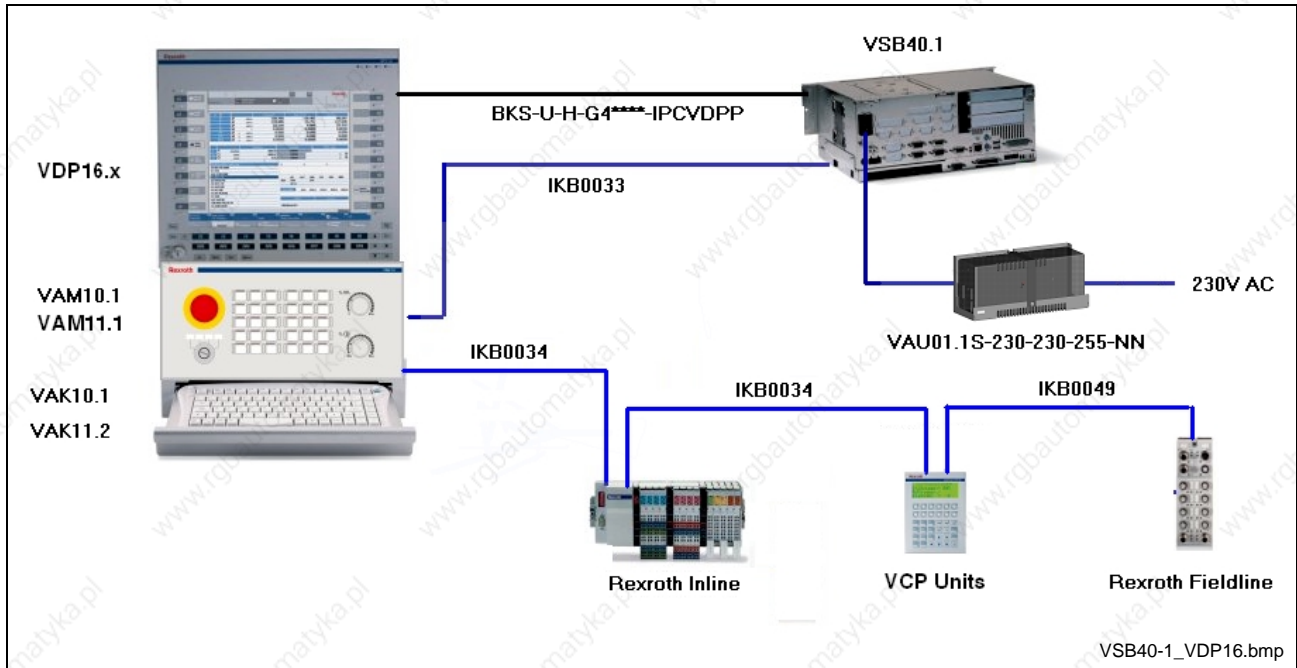

Fig. 16-3: VSB 40.1 with VDP 16

16.4 Standard Industrial PC VSB 40.1 with Operator Panel VDP 40

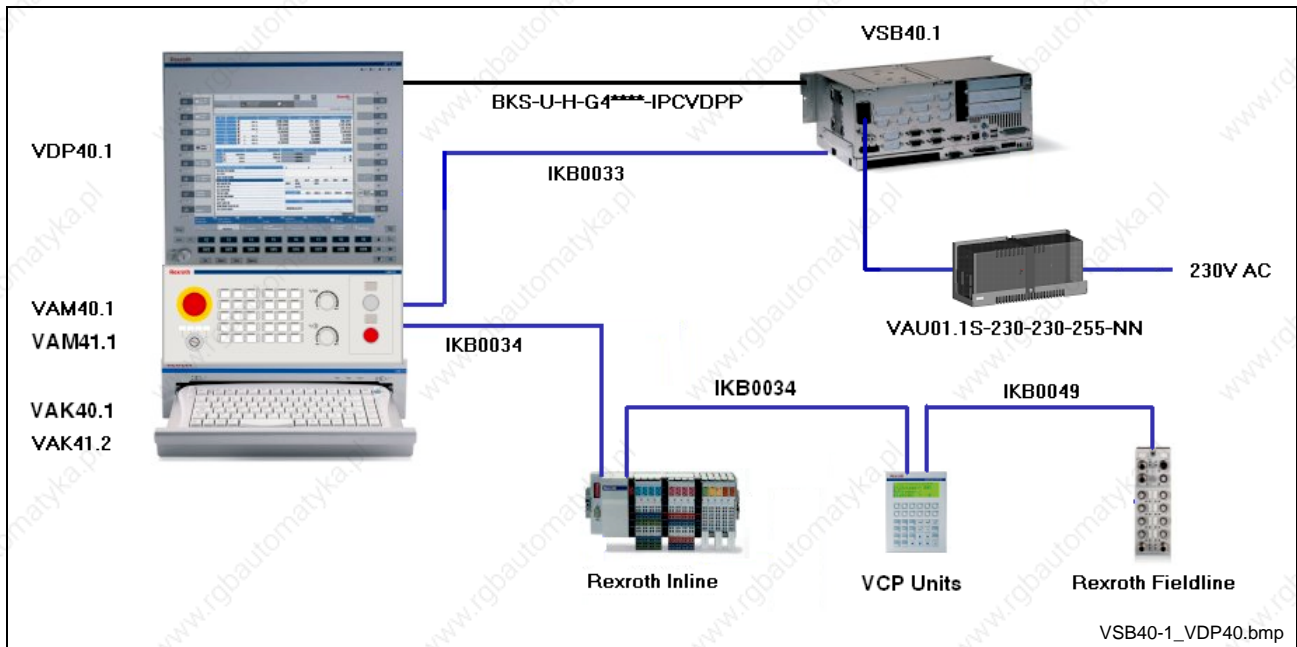

Fig. 16-4: VSB 40.1 with VDP 40

16.5 High-End Industrial PC BTV 16.2 / VPP 16.1

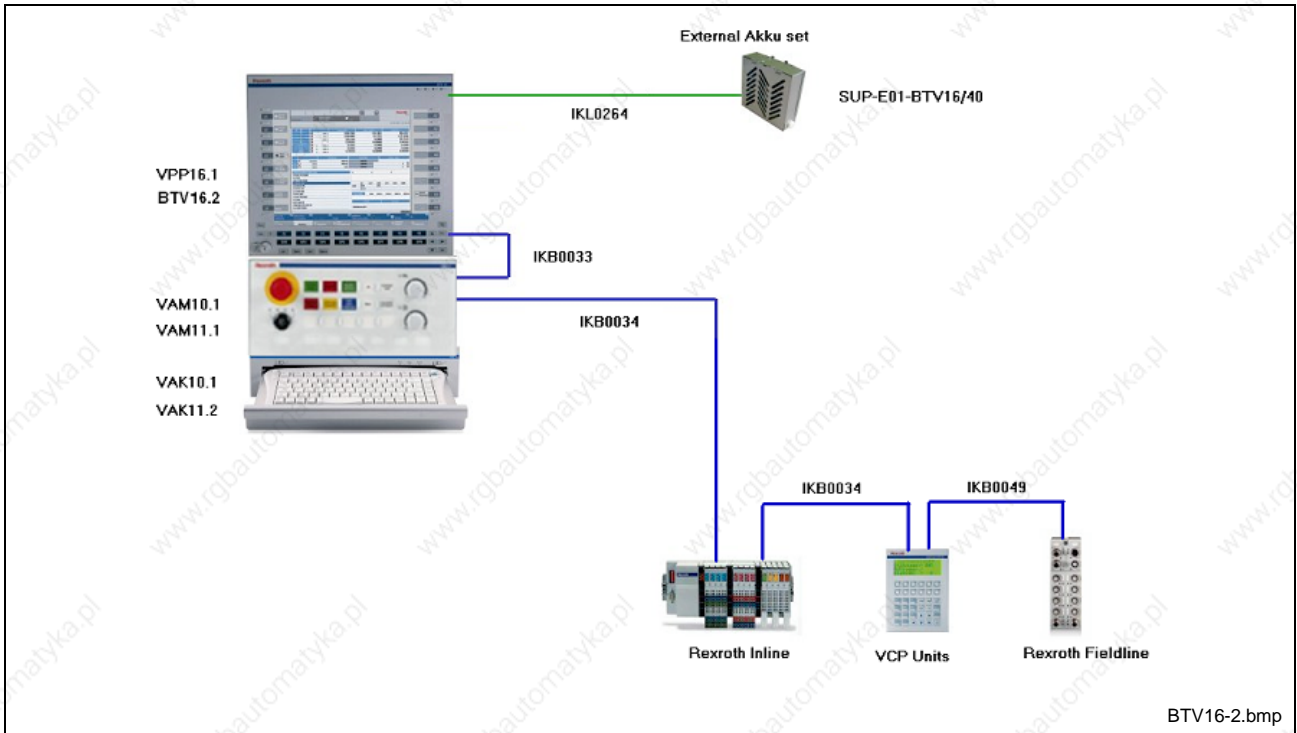

Fig. 16-5: BTV 16.2

16.6 High-End Industrial PC BTV 40.2 / VPP 40.1

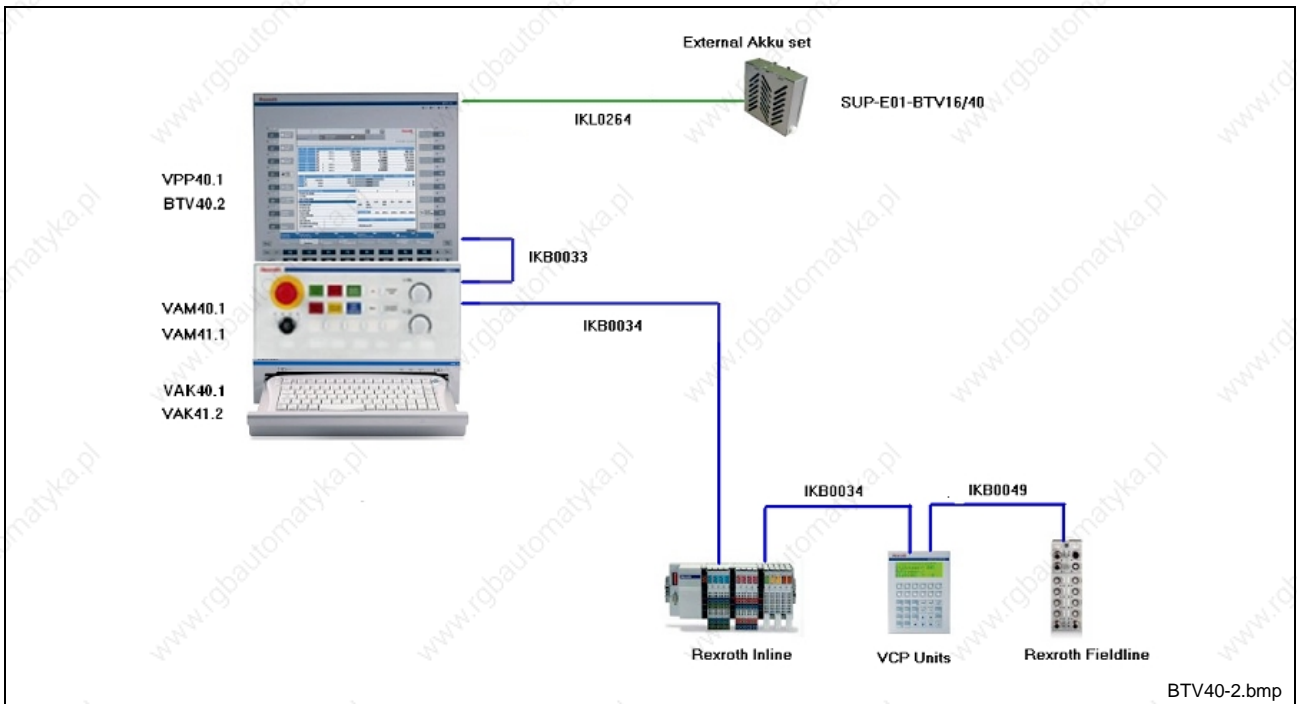

Fig. 16-6: BTV 40.2

16.7 High-End Industrial PC IPC 40.2 / VPB 40.1 with Operator Panel VDP 16

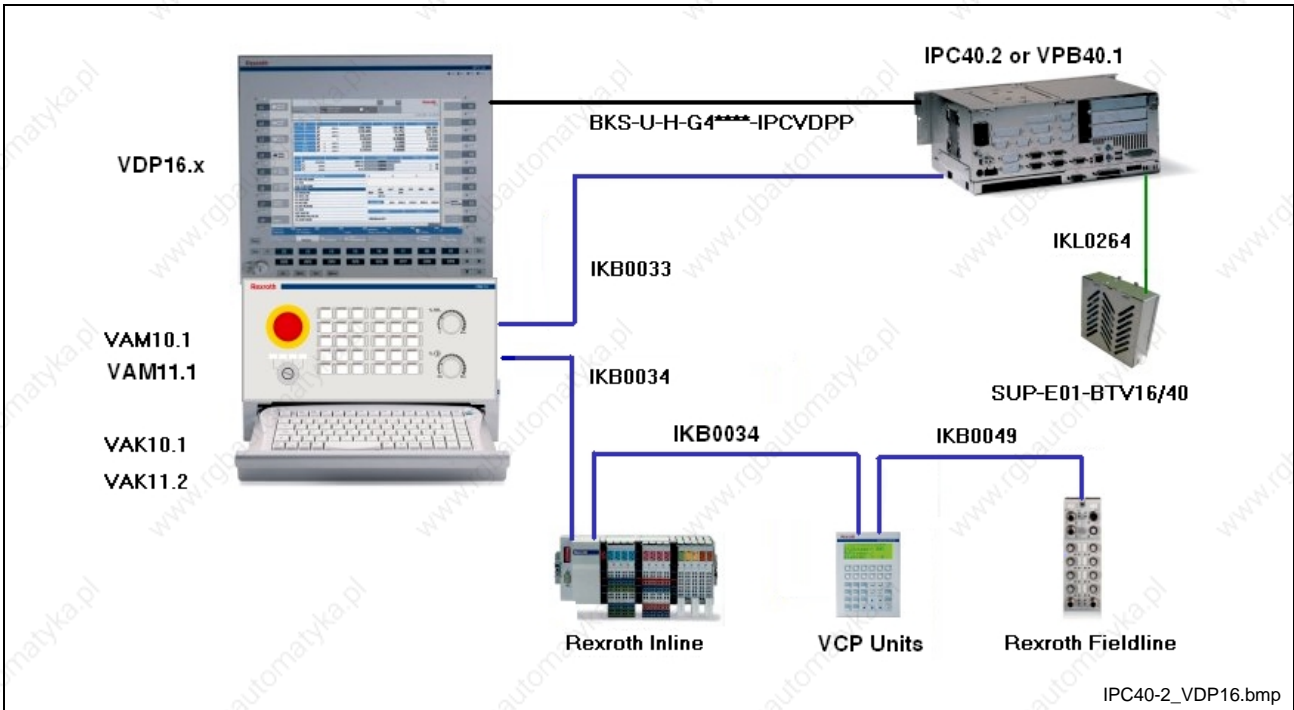

Fig. 16-7: IPC 40.2 / VPB 40.1 with VDP 16

16.8 High-End Industrial PC IPC 40.2 / VPB 40.1 with Operator Panel VDP 40

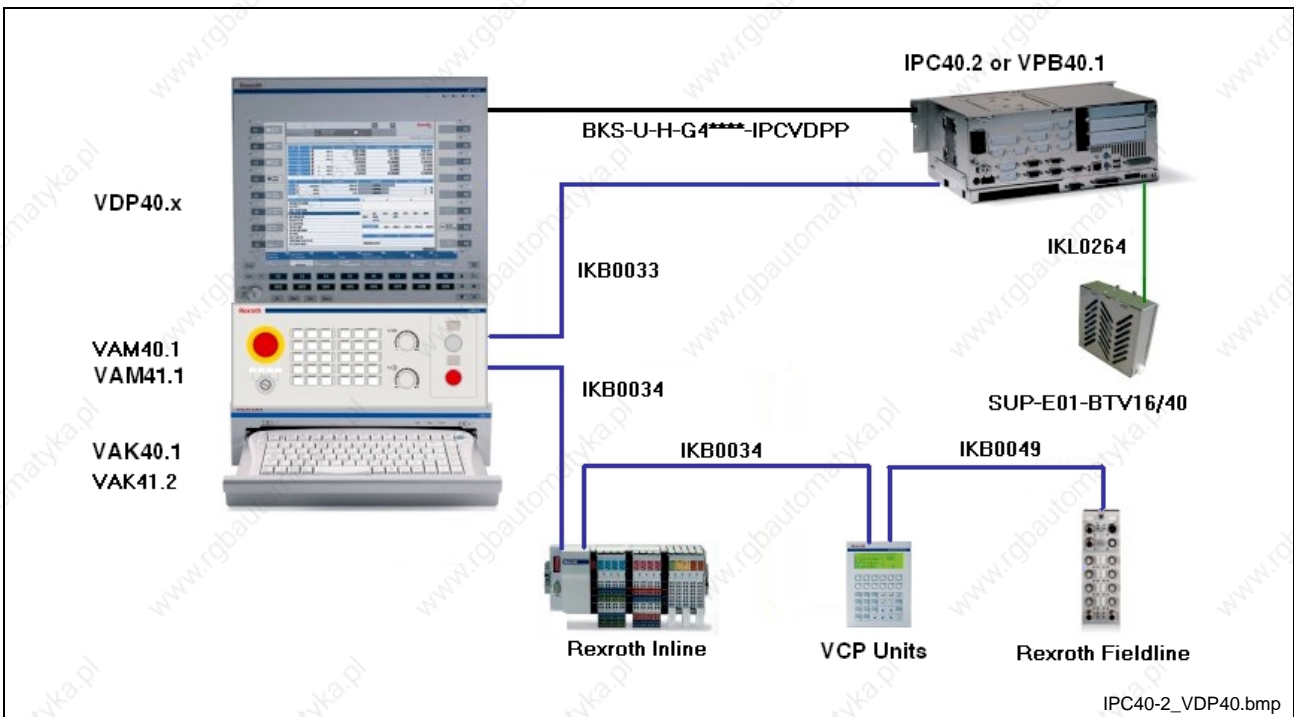

Fig. 16-8: IPC 40.2 / VPB 40.1 with VDP 40

17 Data Backup

17.1 Introduction

Overview

This chapter describes the execution of a data backup at the Rexroth PC operator terminals.

The data backup solution serves to backup and restore the operating system and the installed user programs (total system) in the form of a partition or hard disk image, but not to backup user data "selectively". To backup user data, an additional mechanism is provided under IndraWorks.

Why to Backup Data?

EDP systems are no static systems. Data is continuously created, modified, moved or deleted. Components are added or removed, updates are carried out and settings are modified. There are many reasons to backup this data and settings:

- Saving data in case of a hardware failure
- Restoring the system environment after incorrect operation
- Saving main system settings
- Archiving a system status before carrying out an update
- Providing an identical system environment

Definition of Hardware and Software Requirements

Rexroth Industrial PC The data backup is contained in all PC-based control and HMI systems like MTX, MLC and IL as of Windows XP Service Pack 2.

The used software Acronis True Image is installed and additionally archived on partition C:\ of the industrial PC. The license key for a new installation is visible on the device or is contained in the license documentation.

Backup Media

- PC in the network (backup server)
- USB HDD
- Required memory space per unit to be backed up for a full disk backup is at least 3 GB.

Network

- 10/100 Mbits network
- TCP/IP network protocol
- DHCP server in the network

17.2 System Presentation

As tool to carry out the data backup the software Acronis True Image is used. The software can be started via a desktop icon under Windows, via the Recovery Manager with the F11 key (see section "Acronis Secure Zone and Startup Recovery Manager") or via the bootable rescue media (see section "Bootable Rescue Media or Recovery Manager"). The main program window illustrated below appears. Under Windows only the functions "Disk Clone", "Add New Disk" and "Schedule Task" are provided.

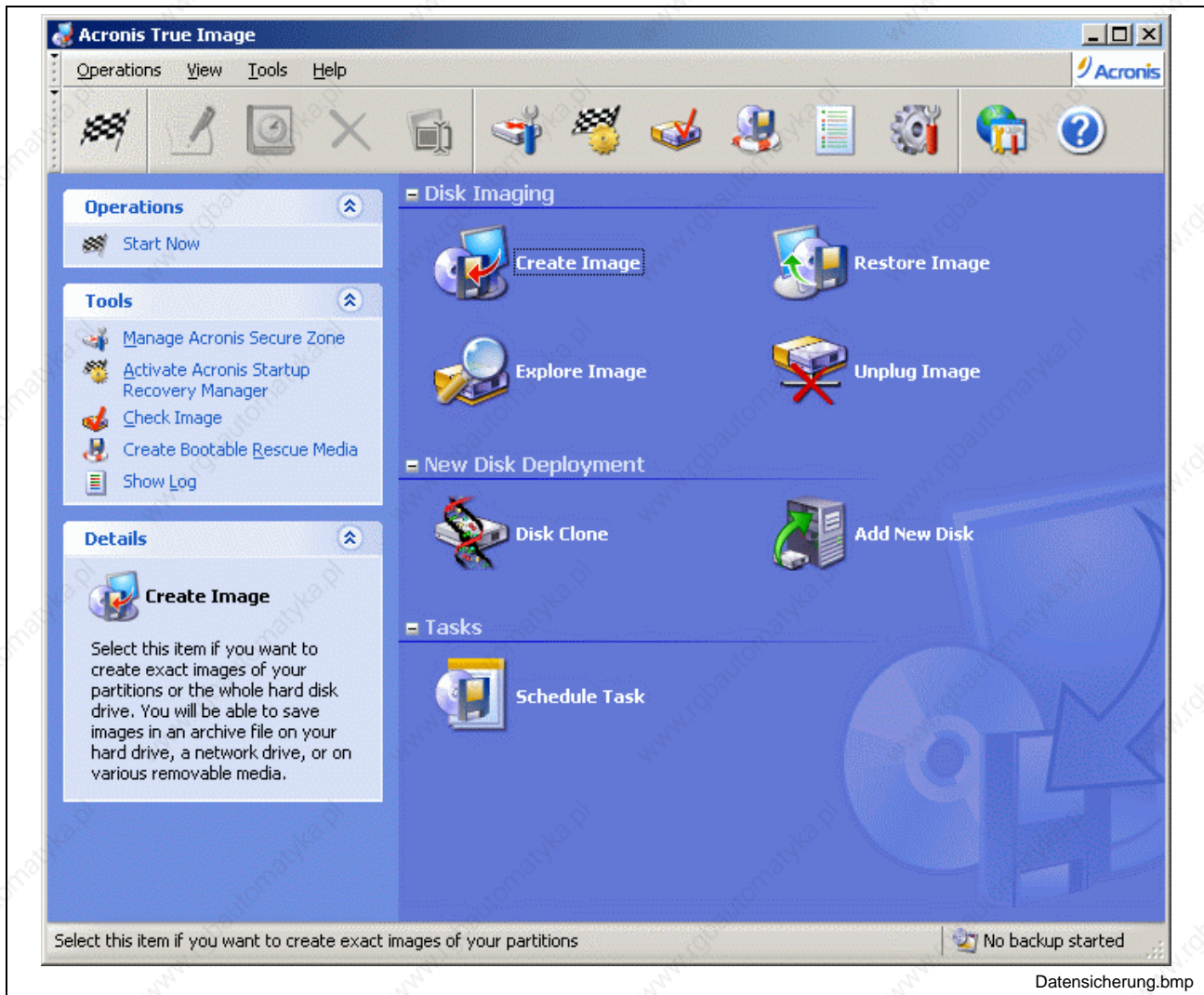

Fig. 17-1: Main window of the Acronis True Image software

Acronis True Image

Acronis True Image is a tool, that provides backup functions for hard disks or partitions. It creates an exact image of the hard disk or single partitions for a full backup and allows to restore all contents, including the operating systems, all programs as well as the personal data and settings. In case of software or hardware problems it restores hard disks and partitions, even if the conventional data backup software or the operating system of the computer don't work.

Images can be saved on the hard disk, writeable CD media and network resources. Wizards designed in WindowsXP style can be intuitively operated and explain step by step the necessary actions.

Image files can be incrementally extended. During the restoration of hard disks or partitions different backup states can be selected.

Archive Files

Archive files have the extension **.tib**. These files contain the images of the partitions or hard disks. In addition, data of the partitions or hard disk and information, with which the restoration is realized, are contained. An archive file can consist of images of several partitions or hard disks.

The saved data can be compressed. The image archive files can be automatically divided into several parts or split up corresponding to a template. The division of the archive file is mostly required, if they are to be saved on a removable media.

Note: It is not recommended to archive images directly on removable media like e. g. CDs, as a flow control of the data is missing because of the direct writing on CD.

Furthermore, it is recommended to divide the image archive during its creation into the corresponding size and to transmit the files after the backup process to the removable media.

Images of partitions contain all files and directories, independent of their properties (hidden, system, etc.), the Master Boot Record (MBR), the File Allocation Table and the Root directory.

In a partition image only the hard disk sectors containing user data are saved. The image archives can be protected by a password.

Incremental Backup

An image archive contains one or several images. Images are identical copies of partitions or entire hard disks, that are usually compressed. It is not only possible, to record several partitions or hard disks in an archive file and to restore them separately, the data of an image archive can also be updated. To achieve this, a technology is used, that is similar to the incremental data backup. Thereby, only the data modified since the last image creation are saved. This process saves time and memory space. Please consider that the basis of an incremental backup is always a preceding full disk backup. Therefore, the software analyzes at first, if an incremental backup is possible. If a full disk backup does not exist, it is always created at first.

A further advantage of this proceeding is: The restoration of a partition from the image archive is possible with different states generated from different image creation times. Not only the image of the respective last backup, but also e. g. the image created at a certain time in the past can be restored.

17.3 Acronis Secure Zone and Startup Recovery Manager

Acronis Secure Zone In the case, that local partitions are damaged and e. g. cannot boot anymore, but the HDD is still alright, it is possible to restore images locally from the Acronis Secure Zone.

The Acronis Secure Zone is a zone on the hard disk, that is inaccessible by ordinary Windows applications. Image archives for quick restoration of partitions or hard disks can be safely archived in this especially protected hard disk partition. Additionally, the Acronis Secure Zone includes parts of the Acronis Startup Recovery Manager, with which the Acronis True Image can be activated in error case before starting the operating system and with which a corrupted system partition can be restored. Thus, partitions can be restored, even if the Windows operating system does not start anymore. Also the rescue media to start Acronis True Image is not required, as the information to execute the program is integrated in the Acronis Startup Recovery Manager.

Note: The Acronis Secure Zone is created as logic drive in the extended partition. The used file system is FAT32. It can't be accessed via a drive letter. Furthermore, there's no direct access to the image archives stored there, except for Acronis True Image itself.

Acronis Startup Recovery Manager The Acronis Startup Recovery Manager is a boot manager with mini operating system, with which Acronis True Image can be started by pressing the F11 key independent of the installed Windows, before a possibly damaged operating system boots. The main task of the Acronis Startup Recovery Manager is to restore damaged operating system partitions. Certainly, also other partitions can be restored. System partitions cannot be saved during running operation. The Acronis True Image started from Acronis Startup Recovery Manager offers all functions, that are also possible during the start of a rescue media.

Creating the Acronis Secure Zone

When a Rexroth industrial PC is delivered, the Acronis Secure Zone is already created. However, if after a hard disk exchange a saved hard disk image is restored, it might be necessary to recreate the Secure Zone.

The creation of the Acronis Secure Zone is started in the main program window via icon **Manage Acronis Secure Zone**. The wizard to manage the Acronis Secure Zone opens.

1. **Start window**
2. **Select the desired action**
Select here **Create Acronis Secure Zone**.
3. **Memory space for the Acronis Secure Zone**
Selection of a partition providing memory space for the Acronis Secure Zone.

Note: It is urgently recommended to subtract this memory space from data partitions (usually D:\), and not from the operating system partition.

4. **Size of the Acronis Secure Zone**
Enter the desired size of the Acronis Secure Zone via a slider or direct input. The proposed value can be applied, as the size can be modified later at any time.

Note: To have enough memory space for a basic backup and supplementary incremental backups, a size of 10 GB is recommended for the Acronis Secure Zone. This size also corresponds to the delivery status.

5. **Acronis Startup Recovery Manager**
Activate Acronis Startup Recovery Manager here!
6. **Finish the wizard**
After finishing the wizard the Acronis Secure Zone is created.

Resizing Acronis Secure Zone

If during the creation the selected size turns out to be unfavorable, the size of the Acronis Secure Zone can be subsequently modified.

The modification of the Acronis Secure Zone's size is started in the main program window via icon **Manage Acronis Secure Zone**. The wizard to manage the Acronis Secure Zone opens.

1. **Start window**
2. **Select the desired action**
Select here **Manage Acronis Secure Zone**.
3. **Resizing Acronis Secure Zone**
Here, you can increase or decrease the size of the Acronis Secure Zone.
 - When the size is increased, unallocated memory space on the hard disk is used for the extension of the Acronis Secure Zone. If there's not enough unallocated memory space, you can select, from which partition the required memory space is to be taken.
 - To decrease the memory space, you must select a partition, to which the memory space becoming free is allocated. Otherwise the achieved memory space is released in an unallocated manner.
4. **Size**
Here, you can enter the new size of the Acronis Secure Zone via a slider or via direct input.
5. **Finishing the wizard**
After finishing the wizard the size is modified.

Reactivating Acronis Startup Recovery Manager

When the Rexroth industrial PCs are delivered, the Startup Recovery Manager is activated. However, if after a hard disk exchange a saved hard disk image is restored, it might be necessary to reactivate the Startup Recovery Manager.

You can activate the Startup Recovery Manager by clicking on the **Activate Acronis Startup Recovery Manager** icon in the main program window. The wizard to activate the Startup Recovery Manager opens.

The complete activation consists of only two windows. The activation is started by pressing the "Proceed" button.

17.4 Creating Image Archives

Note: Before the image creation you must ensure, that there's enough space on the target data carrier to store the image archive.

Note: It is only allowed to backup data, if the Windows operating system and the machine control are running and after explicit release of the respective control system (MTX, MLC, IL).
Generally, it is recommended to backup Windows system partitions via the Acronis Startup Recovery Manager, if the Windows operating system is not running.

The main program window contains the **Create Image** icon. After double-clicking on this icon, the wizard starts for image creation.

1. **Start window**
2. **Selecting partition(s) to image**
You can select the partition(s) to be imaged by check boxes.

Note: While selecting the partition(s) to be imaged, also the Acronis Secure Zone is indicated. If this partition or the complete hard disk 1 including the Acronis Secure Zone is selected for backup, a note appears, that an image of this zone is not recommended, as it contains itself only backed up images.
If you don't select the Acronis Secure Zone, the images including the incremental images archived in this zone get lost.

3. **Selecting image locations and file names**
Selecting image location and file names for the image archive. Two buttons are available in this window.
 - Create new folder.
 - File name. Creates a file name for the image archive.
4. **Full / incremental image archive**
Selection, if a full image archive is to be created or if an existing image archive is to be incrementally extended.
5. **Splitting the image archive file in several volumes**
Here, you can set how your image archive file is to be split up. The setting "Automatic" is recommended. To archive the split image archive on a removable media, enter here the appropriate file size.
6. **Compression level**
The higher the compression level, the smaller is the memory space requirement for the image archive file. However, the required time to create and restore the image archive file is higher. The compression level "Normal" is recommended.

7. Protecting the image archive

The image archive can be protected against unauthorized access or restoration.

8. Comment

Here, you can enter a meaningful comment about the image archive file. This comment will simplify the identification of the image archive file at a later time.

9. Finish

Finishing the wizard for image creation and start of the image creation.

Note: To finish the creation of an image archive file it is strongly recommended to check it by using function "Check Image" from the main window.

17.5 Checking Image Archives

Image archives serve to backup or archive data. Thus, the data integrity is the most important property of an image archive. Therefore, take your time to check image archives after their creation.

For this purpose, you will find the command **Check Image** in the main program window of Acronis True Image under Tools.

The only step after the start window serves to select the image archive file to be checked. Acronis True Image automatically focuses on the file containing the last backup.

After clicking on **Proceed** Acronis True Image starts to check the archive.

At the end of the test procedure, a message appears indicating the success of the action.

Note: If Acronis True Image finds an error, the image creation should be repeated. Thereby, it is recommended to select another data carrier as image location.

Generally, as described beforehand, it is recommended to check the image archive directly after its creation.

17.6 Updating and Extending Image Archives

It is not necessary to execute a full backup after each modification of the original partitions. For this, the incremental image creation can be executed. Furthermore, it can be used to extend an image archive in a manner, that a further partition can be additionally imaged in it.

During an incremental image creation, only the sectors of the partitions or hard disk are saved, that have been changed since the last complete image creation. This information is saved as part of the image archive in a new file in the directory of the image archive. The name of the new file is the file name of the image archive in conjunction with a consecutive number. Incremental image creation is only reasonable on hard disk or network drives, because a full disk backup as it is executed when using a removable media is no longer provided when writing the incremental file.

The incremental backup is started in the main program window with the **Create Image** icon. The wizard to create the image opens.

1. **Start window**
2. **Selecting partition(s) to image**
You can select the partition (or several partitions) to be imaged with check boxes.
3. **Selecting image locations and file names**
Selecting the image archive file to be updated or extended.
4. **Full / incremental image archive**
Select an existing image archive to extend it incrementally. For this, you must select **Add Incremental Image to Archive** as mode for the image creation. If the image archive selected under 3rd is password-protected, it must be entered here.

Warning: If at this place option "Overwrite image archive with full image" is activated, the image archive must be completely recreated. Possibly existing former incremental backups get lost!

The further steps correspond to the proceeding described under "Create image archives".

Note: If you add a comment during an incremental backup, it overwrites the comment to the image archive existing beforehand.
If you want to describe the single incremental backup states in the comment, you must enter the comment of the preceding backup once more and you must extend this comment by information on the current backup.

17.7 Restoring Image Archives

It might be possible to restore images because of various reasons. The most frequent causes are hard disk defects, a virus, the restoration after a program test or a defect of the operating system, e. g. by working with the registration editor.

The restoration of one or several partitions from an image archive is started in the main program window via the "**Restore Image**" icon. The wizard to restore the image starts.

Note: It is recommended to restore image archives only with the Startup Recovery Manager or the rescue media.
Windows system partitions can only be restored by the Startup Recovery Manager or by the rescue media.

1. Start window**2. Image archive selection**

Selection of the image archive to be restored.

If the image archive is password-protected, it has to be entered here.

If the image archive is an incrementally extended image, the date of the desired status must be selected here. The restored data correspond to the status of the selected creation time.

3. Verify archive before the restoring

Here, the image archive can be verified once more before the restoration. As the recommended proceeding is to check the backup after the image archive creation, the default setting is "No, I don't want to verify".

4. Partition or hard disc to restore

Here, the partitions or hard disks backed up in the image archive are indicated. The hard disk or partition to be restored must be selected here.

Note:

It is recommended to select only one partition. If you continue using the wizard, it is possible to select further partitions separately for restoration. Thus, in case of e. g. a hard disk exchange the size of the individual partitions can be adapted to the new hard disk.

If you select the complete hard disk 1 for restoration, the partition sizes are automatically adapted as follows:

- **Target hard disk is smaller than the hard disk, from which the image was created:**

All partitions including the Acronis Secure Zone are automatically decreased. A manual adaptation of the partition sizes is not possible.

- **Target hard disk is equal to the hard disk, from which the image was created:**

All partitions including the Acronis Secure Zone keep their original size. A manual adaptation of the partition sizes is not possible.

- **Target hard disk is greater than the hard disk, from which the image was created:**

All partitions including the Acronis Secure Zone keep their original size. A manual adaptation of the partition sizes is not possible.

5. Restored partition location

Selection of the target, to which the chosen partition is to be restored.

Note:

The target zone is to be carefully selected, so that the right hard disk zone is overwritten.

- If you select a target hard disk or a target partition, the selected target hard disk or partition is overwritten.
 - If as target sector a non-partitioned sector of the hard disk is specified, a new partition is created.
-

**Re-Backup at Running Windows
Operating System**

If an existing partition is selected as target of the restoration, it is locked after confirming with "Next". If files of this partition are opened, Acronis True Image indicates the selection box "Confirmation".

- **Click more...** to view a list of the opened files.
- **Dismount** this disk. All opened files on this disk will be automatically closed.
- **Retry** is selected after having closed all opened files manually.
- **Reboot.** Acronis True Image shuts the computer down and restarts it. Before the start of the operating system the Acronis True Image is activated via the Recovery Manager and it is possible to restore the image without the need, that the files are opened. This option is necessary, if e. g. an operating system partition or a partition with cyclic data access has to be restored.
- **Choose another disk.** Choose another disk.

6. Restored partition type

The original partition type of the image is preset. An exception is the case, if the image is to be created on an unallocated hard disk memory. Then, a logic drive is preset in the extended partition. In the description box the following display appears: Note: The original partition type is set, if the original partition type was selected.

- **Operating system partition:** Active:
- **Data partition:** Logical
- **Secure Zone:** Logical

7. File system

Concerning partition images in a FAT16 or a FAT32 file system a step follows, with which the file system of the restored partition can be modified. For all other files systems the original file system is preset. Select always FAT32 for the Acronis Secure Zone.

8. Restored partition size

Input of the desired size, in which the partition is to be restored. The partition size is set either by graphical moving of the bar indication or by manual input of the desired values.

9. Logical drive letters

In this step the drive letter for the restored partition can be selected.

Note: The proposed drive letter should only be changed, if the corresponding partition is a data partition. Otherwise, only the proposed drive letter should be used.

10. Check file system after the restoring

Selection, if the file system should be checked after its restoration. It is recommended to execute this check.

11. Next selection

As described beforehand, it is possible to select further partitions for restoration.

12. Finishing the wizard

After finishing the wizard the restoration is started.

Note: After the restoration of all partitions on a new hard disk, it is necessary to reactivate the Startup Recovery Manager (see Activate Acronis Startup Recovery Manager).

17.8 Exploring Image Archives

It is possible to allocate drive letters to partition images. After that, it is possible to search the archive with the Windows explorer and to open and copy files from the archive systematically.

Connecting an Image Archive as Drive

The exploring of an image file is started in the main program window with the **Explore Image** icon. The wizard to browse images starts.

1. **Start window**
2. **Select image archive file**
Select the image archive file to be explored.
3. **Assigning logical drive letters**
Selection of a drive letter, under which the partition contained in the image file is to be assigned.
4. **Finishing the wizard**
Finishing the wizard and assignment of the drive letter.

Note: If an image archive consists of several partial archives, they must be available as a whole to assign the contained images.
Therefore, it is not possible to integrate images distributed on CDs. If this should be necessary, all partial archives must be copied in a common directory on the hard disk.

Unplugging Drive Connection

After exploring the image Acronis True Image must be used to cancel the assignment of the temporary drive letters.

With a double-click on the **Unplug Image** icon the wizard starts to unplug images. It appears with a start screen.

This wizard offers only one step to make settings: With step **Logical drive unplugging** the drive to be unplugged is selected by clicking on the corresponding check box. After clicking on **Proceed** in the following step the assignment of the drive letter is canceled: After that, a dialog box will inform you about the success of the action.

17.9 Creating a Bootable Rescue Media

In the case of irreparable hard disks or after the installation of a new hard disk, the computer can be started with Acronis True Image via a bootable rescue media on an external data carrier.

The bootable rescue media can be created on the following data carriers:

- **CD.** An installed or an USB CD-R drive is required.
- **Disk set** consisting of 7 disks with 1,44 MB and 3,5". An installed or an USB FDD drive is required.

The creation of the bootable rescue media is started in the main program window via the **Create Bootable Rescue Media** icon. The wizard to create bootable rescue media opens.

1. **Start window**
2. **Note window.** If there is currently no device connected to the drive or if no CD/R drive is connected, a note window appears.
3. **Rescue media contents.**
 - Full version (recommended): It contains a great number of drivers.
 - Safe version (not recommended): Should only be used, if problems occur when using the "Full version".
4. **Removable disk drive selection.** In a list the existing removable disk drives are indicated for selection.
5. **Insert data carrier.** Request to insert a corresponding data carrier in the selected drive. The activation is started by pressing the "Proceed" button.
6. **Finishing the wizard.** The successful creation of the bootable rescue media is indicated here. The wizard is finished with the "OK" button.

17.10 Network Support

Windows Software

There are no settings necessary for the Windows software. The available Windows network is used.

Bootable Rescue Media or Recovery Manager

Network with DHCP Server

In networks with DHCP server it is not necessary to make settings neither in the bootable rescue media nor after the start of Acronis True Image via the Recovery Manager.

Network without DHCP Server

In networks without DHCP server it is not necessary to enter data manually after the start of the bootable rescue media or after the start of Acronis True Image via the Recovery Manager.

Via Tools – Options the network adapter (eth0) can be configured. At least, the IP address, the subnet mask and the default gateway must be entered.

Network adapter	Display of the network adapter.
Hardware address	Display of the MAC address
DHCP	Display, if used / not used.
IP address	Display of the IP address
Subnet mask	Input of the subnet mask
DNS suffix	Optional
Default gateways	Display of the default gateway's IP address
DNS servers	Optional
WNS servers	Optional

Fig. 17-2: Manual network configuration of the rescue media

If the network settings are manually input, after double-clicking on **Computers near me** partially no network resources are indicated. Here the UNC path name must be entered in the file name box (e. g. **\\server\Enable** or **\\<ip_address>\enable**). When accessing another computer in the network the user name and the password are requested. To log in a Windows domain, place the name of the domain followed by a backslash before the user name (e. g. **domain\user**).

17.11 Scheduling a Task

To keep the backups automatically on a status as up-to-date as possible, you can create tasks (time-controlled backup orders).

Note: It is recommended to determine, that such tasks are executed at times, at which the control systems are not in productive operation.

Tasks can only be created in the main program window under Windows. The proceeding is the same as for "Create image archives" extended by the time settings.

1. **Start window**
2. **Selecting partitions to image**
3. **Selecting memory location and file name**
4. Full / incremental image archive
5. **Password input**
6. Splitting the image archive file
7. **Compression level**
8. **Comment**
9. **Start time**

Here, it is possible to assign a certain execution time to task:

- **Start not automatically**
Don't start the task automatically. If required, the task can be manually started via "Execute".
- **Daily**
Setting the start time. Furthermore, you can select, if the task is to be executed daily, on weekdays or every X days.
- **Weekly**
Setting the start time, the sequence (every X weeks) and the weekday / weekdays, at which the task is to be executed.
- **Monthly**
Setting the start time and the day in the month, at which the task is to be executed.

18 Index

A

Appropriate use
Areas of application 2-1
Introduction 2-1
Operational use 2-1

B

Battery pack 10-1
BTV 16 1-1, 4-8, 7-1, 11-2, 16-3
BTV 40 1-1, 4-8, 7-1, 11-2, 16-3

C

Chemical resistance 4-2
CMP 40 1-1, 4-1, 5-1, 6-1
CMP 60 1-1, 4-1, 5-1, 6-1, 7-1, 8-1, 11-2, 14-3

D

Data Backup 17-1
Digital inputs 4-7
Digital outputs 4-6

E

EMV 4-2
Error LED 4-4
Ethernet 4-1, 4-5

G

GIGASTAR interface 6-1

H

High-end industrial PC 1-1, 1-2, 7-1, 10-1
Highspeed I/O interface 4-1, 4-5

I

Inappropriate use 2-2
Consequences, Discharge of liability 2-1
IPC 40 1-1, 4-8, 8-1, 16-4

M

Moisture 4-2

O

Optical fiber 4-4

P

Power Good 4-4
PROFIBUS-DP 1-1, 4-1, 11-2, 13-1, 14-3, 15-1
PROFIBUS-DP Master 4-5

R

Ready contact 4-5

RECO Fieldline 15-1
RECO Inline 1-1, 13-1
Rexroth Fieldline 1-1

S

Safety Instructions for Electric Drives and Controls 3-1
SERCOS interface 4-1, 4-4
Standard industrial PC 1-1, 1-2, 5-1, 6-1, 9-1

T

Temperature 4-2

U

UPS 9-1
Use See appropriate use and *inappropriate use*

V

VAK 10 1-1, 12-1
VAK 11 1-1, 12-2
VAK 40 1-1, 12-1
VAK 41 1-1, 12-2
VAM 10 1-1, 11-1
VAM 11 11-1
VAM 40 1-1, 11-1
VAM 41 11-1
VCP 02 14-1
VCP 05 14-1
VCP 08 14-1
VCP 20 14-2
VCP 25 14-2
VDP 16 1-1, 6-1, 8-1, 11-2, 12-1, 12-2, 16-2, 16-4
VDP 40 1-1, 6-1, 8-1, 11-2, 12-1, 12-2, 16-2, 16-4
VPB 40 4-8, 8-1
VPP 16 1-1, 4-8, 7-1, 11-2
VPP 40 1-1, 4-8, 7-1, 11-2
VSB 40 4-8, 6-1, 16-2
VSP 16 1-1, 4-8, 5-1, 11-2, 12-1, 12-2, 16-1
VSP 40 1-1, 4-8, 5-1, 11-2, 12-1, 12-2, 16-1

W

Watchdog 4-4

19 Service & Support

19.1 Helpdesk

Unser Kundendienst-Helpdesk im Hauptwerk Lohr am Main steht Ihnen mit Rat und Tat zur Seite. Sie erreichen uns

- telefonisch - by phone:
über Service Call Entry Center
- via Service Call Entry Center
- per Fax - by fax:
- per e-Mail - by e-mail:

+49 (0) 9352 40 50 60

Mo-Fr 07:00-18:00
Mo-Fr 7:00 am - 6:00 pm

+49 (0) 9352 40 49 41

service.svc@boschrexroth.de

Our service helpdesk at our headquarters in Lohr am Main, Germany can assist you in all kinds of inquiries. Contact us

19.2 Service-Hotline

Außerhalb der Helpdesk-Zeiten ist der Service direkt ansprechbar unter

+49 (0) 171 333 88 26

oder - or

+49 (0) 172 660 04 06

After helpdesk hours, contact our service department directly at

19.3 Internet

Unter www.boschrexroth.com finden Sie ergänzende Hinweise zu Service, Reparatur und Training sowie die **aktuellen** Adressen *) unserer auf den folgenden Seiten aufgeführten Vertriebs- und Servicebüros.



Verkaufsniederlassungen



Niederlassungen mit Kundendienst

Außerhalb Deutschlands nehmen Sie bitte zuerst Kontakt mit unserem für Sie nächstgelegenen Ansprechpartner auf.

*) Die Angaben in der vorliegenden Dokumentation können seit Drucklegung überholt sein.

At www.boschrexroth.com you may find additional notes about service, repairs and training in the Internet, as well as the **actual** addresses *) of our sales- and service facilities figuring on the following pages.



sales agencies



offices providing service

Please contact our sales / service office in your area first.

*) Data in the present documentation may have become obsolete since printing.

19.4 Vor der Kontaktaufnahme... - Before contacting us...

Wir können Ihnen schnell und effizient helfen wenn Sie folgende Informationen bereithalten:

1. detaillierte Beschreibung der Störung und der Umstände.
2. Angaben auf dem Typenschild der betreffenden Produkte, insbesondere Typenschlüssel und Seriennummern.
3. Tel./Faxnummern und e-Mail-Adresse, unter denen Sie für Rückfragen zu erreichen sind.

For quick and efficient help, please have the following information ready:

1. Detailed description of the failure and circumstances.
2. Information on the type plate of the affected products, especially type codes and serial numbers.
3. Your phone/fax numbers and e-mail address, so we can contact you in case of questions.

19.5 Kundenbetreuungsstellen - Sales & Service Facilities

Deutschland - Germany

vom Ausland:

(0) nach Landeskennziffer weglassen!

from abroad:

don't dial (0) after country code!

<p>Vertriebsgebiet Mitte Germany Centre</p> <p>Bosch Rexroth Electrice Drives and Controls GmbH Bgm.-Dr.-Nebel-Str. 2 / Postf. 1357 97816 Lohr am Main / 97803 Lohr</p> <p>Kompetenz-Zentrum Europa</p> <p>Tel.: +49 (0)9352 40-0 Fax: +49 (0)9352 40-4885</p>	<p>SERVICE AUTOMATION</p> <p>CALL ENTRY CENTER Helpdesk MO – FR von 07:00 - 18:00 Uhr from 7 am – 6 pm</p> <p>Tel. +49 (0) 9352 40 50 60 Fax +49 (0) 9352 40 49 41 service.svc@boschrexroth.de</p>	<p>SERVICE AUTOMATION</p> <p>HOTLINE 24 / 7 / 365</p> <p>außerhalb der Helpdesk-Zeit out of helpdesk hours</p> <p>Tel.: +49 (0)172 660 04 06 oder / or Tel.: +49 (0)171 333 88 26</p>	<p>SERVICE AUTOMATION</p> <p>ERSATZTEILE / SPARES verlängerte Ansprechzeit - extended office time -</p> <p>♦ nur an Werktagen - only on working days -</p> <p>♦ von 07:00 - 18:00 Uhr - from 7 am - 6 pm -</p> <p>Tel. +49 (0) 9352 40 42 22</p>
<p>Vertriebsgebiet Süd Germany South</p> <p>Bosch Rexroth AG Landshuter Allee 8-10 80637 München</p> <p>Tel.: +49 (0)89 127 14-0 Fax: +49 (0)89 127 14-490</p>	<p>Vertriebsgebiet West Germany West</p> <p>Bosch Rexroth AG Regionalzentrum West Borsigstrasse 15 40880 Ratingen</p> <p>Tel.: +49 (0)2102 409-0 Fax: +49 (0)2102 409-406 +49 (0)2102 409-430</p>	<p>Gebiet Südwest Germany South-West</p> <p>Bosch Rexroth AG Service-Regionalzentrum Süd-West Siemensstr. 1 70736 Fellbach</p> <p>Tel.: +49 (0)711 51046-0 Fax: +49 (0)711 51046-248</p>	
<p>Vertriebsgebiet Nord Germany North</p> <p>Bosch Rexroth AG Walsroder Str. 93 30853 Langenhagen</p> <p>Tel.: +49 (0) 511 72 66 57-0 Service: +49 (0) 511 72 66 57-256 Fax: +49 (0) 511 72 66 57-93 Service: +49 (0) 511 72 66 57-783</p>	<p>Vertriebsgebiet Mitte Germany Centre</p> <p>Bosch Rexroth AG Regionalzentrum Mitte Waldecker Straße 13 64546 Mörfelden-Walldorf</p> <p>Tel.: +49 (0) 61 05 702-3 Fax: +49 (0) 61 05 702-444</p>	<p>Vertriebsgebiet Ost Germany East</p> <p>Bosch Rexroth AG Beckerstraße 31 09120 Chemnitz</p> <p>Tel.: +49 (0)371 35 55-0 Fax: +49 (0)371 35 55-333</p>	<p>Vertriebsgebiet Ost Germany East</p> <p>Bosch Rexroth AG Regionalzentrum Ost Walter-Köhn-Str. 4d 04356 Leipzig</p> <p>Tel.: +49 (0)341 25 61-0 Fax: +49 (0)341 25 61-111</p>

Europa (West) - Europe (West)

vom Ausland: (0) nach Landeskennziffer weglassen,
from abroad: don't dial (0) after country code,

Italien: 0 nach Landeskennziffer mitwählen
Italy: dial 0 after country code

<p>Austria - Österreich</p> <p>Bosch Rexroth GmbH Electric Drives & Controls Stachegasse 13 1120 Wien</p> <p>Tel.: +43 (0) 1 985 25 40 Fax: +43 (0) 1 985 25 40-1459</p>	<p>Austria – Österreich</p> <p>Bosch Rexroth GmbH Electric Drives & Controls Industriepark 18 4061 Pasching</p> <p>Tel.: +43 (0)7221 605-0 Fax: +43 (0)7221 605-1220</p>	<p>Belgium - Belgien</p> <p>Bosch Rexroth NV/SA Henri Genessestraat 1 1070 Bruxelles</p> <p>Tel: +32 (0) 2 451 26 08 Fax: +32 (0) 2 451 27 90 info@boschrexroth.be service@boschrexroth.be</p>	<p>Denmark - Dänemark</p> <p>BEC A/S Zinkvej 6 8900 Randers</p> <p>Tel.: +45 87 11 90 60 Fax: +45 87 11 90 61</p>
<p>Denmark - Dänemark</p> <p>Bosch Rexroth A/S Engelsholmvej 26 8900 Randers</p> <p>Tel.: +45 36 77 44 66 Fax: +45 70 10 03 20 tj@boschrexroth.dk</p>	<p>Great Britain – Großbritannien</p> <p>Bosch Rexroth Ltd. Electric Drives & Controls Broadway Lane, South Cerney Cirencester, Glos GL7 5UH</p> <p>Tel.: +44 (0)1285 863-000 Fax: +44 (0)1285 863-030 sales@boschrexroth.co.uk service@boschrexroth.co.uk</p>	<p>Finland - Finnland</p> <p>Bosch Rexroth Oy Electric Drives & Controls Ansatie 6 017 40 Vantaa</p> <p>Tel.: +358 (0)9 84 91-11 Fax: +358 (0)9 84 91-13 60</p>	<p>France - Frankreich</p> <p>Bosch Rexroth SAS Electric Drives & Controls Avenue de la Trentaine (BP. 74) 77503 Chelles Cedex</p> <p>Tel.: +33 (0)164 72-63 22 Fax: +33 (0)164 72-63 20 Hotline: +33 (0)608 33 43 28</p>
<p>France - Frankreich</p> <p>Bosch Rexroth SAS Electric Drives & Controls ZI de Thibaud, 20 bd. Thibaud (BP. 1751) 31084 Toulouse</p> <p>Tel.: +33 (0)5 61 43 61 87 Fax: +33 (0)5 61 43 94 12</p>	<p>France – Frankreich</p> <p>Bosch Rexroth SAS Electric Drives & Controls 91, Bd. Irène Joliot-Curie 69634 Vénissieux – Cedex</p> <p>Tel.: +33 (0)4 78 78 53 65 Fax: +33 (0)4 78 78 53 62</p>	<p>France – Frankreich</p> <p>Tightening & Press-fit: Globe Techniques Nouvelles 143, Av. du Général de Gaulle 92252 La Garenne Colombes</p> <p>Tel.: +33 (0)1 41 19 33 33</p>	<p>Italy - Italien</p> <p>Bosch Rexroth S.p.A. Strada Statale Padana Superiore 11, no. 41 20063 Cernusco S/N.MI</p> <p>Hotline: +39 02 92 365 563 Tel.: +39 02 92 365 1 Service: +39 02 92 365 300 Fax: +39 02 92 365 500 Service: +39 02 92 365 516</p>
<p>Italy - Italien</p> <p>Bosch Rexroth S.p.A. Via Paolo Veronesi, 250 10148 Torino</p> <p>Tel.: +39 011 224 88 11 Fax: +39 011 224 88 30</p>	<p>Italy - Italien</p> <p>Bosch Rexroth S.p.A. Via Mascia, 1 80053 Castellamare di Stabia NA</p> <p>Tel.: +39 081 8 71 57 00 Fax: +39 081 8 71 68 85</p>	<p>Italy - Italien</p> <p>Bosch Rexroth S.p.A. Via del Progresso, 16 (Zona Ind.) 35020 Padova</p> <p>Tel.: +39 049 8 70 13 70 Fax: +39 049 8 70 13 77</p>	<p>Italy - Italien</p> <p>Bosch Rexroth S.p.A. Via Isonzo, 61 40033 Casalecchio di Reno (Bo)</p> <p>Tel.: +39 051 29 86 430 Fax: +39 051 29 86 490</p>
<p>Italy - Italien</p> <p>Tightening & Press-fit: TEMA S.p.A. Automazione Via Juker, 28 20025 Legnano</p> <p>Tel.: +39 0 331 4671</p>	<p>Netherlands – Niederlande/Holland</p> <p>Bosch Rexroth B.V. Kruisbroeksestraat 1 (P.O. Box 32) 5281 RV Boxtel</p> <p>Tel.: +31 (0) 411 65 16 40 Fax: +31 (0) 411 65 14 83 www.boschrexroth.nl</p>	<p>Netherlands - Niederlande/Holland</p> <p>Bosch Rexroth Services B.V. Technical Services Kruisbroeksestraat 1 (P.O. Box 32) 5281 RV Boxtel</p> <p>Tel.: +31 (0) 411 65 19 51 Fax: +31 (0) 411 67 78 14 Hotline: +31 (0) 411 65 19 51 services@boschrexroth.nl</p>	<p>Norway - Norwegen</p> <p>Bosch Rexroth AS Electric Drives & Controls Berghagan 1 or: Box 3007 1405 Ski-Langhus 1402 Ski</p> <p>Tel.: +47 64 86 41 00 Fax: +47 64 86 90 62 Hotline: +47 64 86 94 82 ju.l.ruud@rexroth.no</p>
<p>Spain – Spanien</p> <p>Goimendi Automation S.L. Parque Empresarial Zuatzu C/ Francisco Grandmontagne no.2 20018 San Sebastian</p> <p>Tel.: +34 9 43 31 84 21 - service: +34 9 43 31 84 56 Fax: +34 9 43 31 84 27 - service: +34 9 43 31 84 60 sat.indramat@goimendi.es</p>	<p>Spain - Spanien</p> <p>Bosch Rexroth S.A. Electric Drives & Controls Centro Industrial Santiga Obradors 14-16 08130 Santa Perpetua de Mogoda Barcelona</p> <p>Tel.: +34 9 37 47 94-00 Fax: +34 9 37 47 94-01</p>	<p>Spain - Spanien</p> <p>Bosch Rexroth S.A. Electric Drives & Controls c/ Almazara, 9 28760 Tres Cantos (Madrid)</p> <p>Tel.: +34 91 806 24 79 Fax: +34 91 806 24 72 fernando.bariego@boschrexroth.es</p>	<p>Sweden - Schweden</p> <p>Bosch Rexroth AB Electric Drives & Controls - Varuvägen 7 (Service: Konsumentvägen 4, Älfsjö) 125 81 Stockholm</p> <p>Tel.: +46 (0) 8 727 92 00 Fax: +46 (0) 8 647 32 77</p>
<p>Sweden - Schweden</p> <p>Bosch Rexroth AB Electric Drives & Controls Ekvändan 7 254 67 Helsingborg</p> <p>Tel.: +46 (0) 4 238 88 -50 Fax: +46 (0) 4 238 88 -74</p>	<p>Switzerland East - Schweiz Ost</p> <p>Bosch Rexroth Schweiz AG Electric Drives & Controls Hemrietstrasse 2 8863 Buttikon</p> <p>Tel. +41 (0) 55 46 46 111 Fax +41 (0) 55 46 46 222</p>	<p>Switzerland West - Schweiz West</p> <p>Bosch Rexroth Suisse SA Av. Général Guisan 26 1800 Vevey 1</p> <p>Tel.: +41 (0)21 632 84 20 Fax: +41 (0)21 632 84 21</p>	

Europa (Ost) - Europe (East)

vom Ausland: (0) nach Landeskennziffer weglassen
from abroad: don't dial (0) after country code

Czech Republic - Tschechien	Czech Republic - Tschechien	Czech Republic - Tschechien	Hungary - Ungarn
Bosch -Rexroth, spol.s.r.o. Hviezdoslavova 5 627 00 Brno Tel.: +420 (0)5 48 126 358 Fax: +420 (0)5 48 126 112	DEL a.s. Strojirenská 38 591 01 Zdar nad Sázavou Tel.: +420 566 64 3144 Fax: +420 566 62 1657	Tightening & Press-fit: Bosch -Rexroth, spol.s.r.o. Stetkova 18 140 68 Praha 4 Tel.: +420 (0)241 406 675	Bosch Rexroth Kft. Angol utca 34 1149 Budapest Tel.: +36 (1) 422 3200 Fax: +36 (1) 422 3201
Poland – Polen	Poland – Polen	Romania - Rumänien	Romania - Rumänien
Bosch Rexroth Sp.zo.o. Biuro Poznan ul. Dabrowskiego 81/85 60-529 Poznan Tel.: +48 061 847 64 62 /-63 Fax: +48 061 847 64 02	Bosch Rexroth Sp.zo.o. ul. Staszica 1 05-800 Pruszków Tel.: +48 (0) 22 738 18 00 – service: +48 (0) 22 738 18 46 Fax: +48 (0) 22 758 87 35 – service: +48 (0) 22 738 18 42	East Electric S.R.L. Bdul Basarabia no.250, sector 3 73429 Bucuresti Tel./Fax: +40 (0)21 255 35 07 +40 (0)21 255 77 13 Fax: +40 (0)21 725 61 21 eastel@rdsnet.ro	Bosch Rexroth Sp.zo.o. Str. Drobety nr. 4-10, app. 14 70258 Bucuresti, Sector 2 Tel.: +40 (0)1 210 48 25 +40 (0)1 210 29 50 Fax: +40 (0)1 210 29 52
Russia - Russland	Russia Belarus - Weissrussland	Turkey - Türkei	Turkey - Türkei
Bosch Rexroth OOO Wjatskaja ul. 27/15 127015 Moskau Tel.: +7-095-785 74 78 +7-095 785 74 79 Fax: +7 095 785 74 77 laura.kanina@boschrexroth.ru	ELMIS 10, Internationalnaya 246640 Gomel, Belarus Tel.: +375/ 232 53 42 70 +375/ 232 53 21 69 Fax: +375/ 232 53 37 69 elmis_ltd@yahoo.com	Bosch Rexroth Otomasyon San & Tic. A..S. Fevzi Cakmak Cad No. 3 34295 Sefaköy Istanbul Tel.: +90 212 411-13 00 Fax: +90 212 411-13 17 www.boschrexroth.com.tr	Servo Kontrol Ltd. Sti. Perpa Ticaret Merkezi B Blok Kat: 11 No: 1609 80270 Okmeydani-Istanbul Tel.: +90 212 320 30 80 Fax: +90 212 320 30 81 remzi.sali@servokontrol.com www.servokontrol.com
Slovakia - Slowakei	Slowenia - Slowenien		
Tightening & Press-fit: MTS, spol. s.r.o. 02755 Kriva 53 Tel.: +421 43 5819 161	DOMEL Otoki 21 64 228 Zelezniki Tel.: +386 5 5117 152 Fax: +386 5 5117 225 brane.ozebek@domel.si		

Australien, Süd-Afrika - Australia, South Africa

Australia - Australien	Australia - Australien	South Africa - Südafrika	South Africa - Südafrika
AIMS - Australian Industrial Machinery Services Pty. Ltd. 28 Westside Drive Laverton North Vic 3026 Melbourne Tel.: +61 3 93 14 3321 Fax: +61 3 93 14 3329 Hotlines: +61 3 93 14 3321 +61 4 19 369 195 enquires@aimservices.com.au	Bosch Rexroth Pty. Ltd. No. 7, Endeavour Way Braeside Victoria, 31 95 Melbourne Tel.: +61 3 95 80 39 33 Fax: +61 3 95 80 17 33 mel@rexroth.com.au	TECTRA Automation (Pty) Ltd. 100 Newton Road, Meadowdale Edenvale 1609 Tel.: +27 11 971 94 00 Fax: +27 11 971 94 40 Hotline: +27 82 903 29 23 georgv@tectra.co.za	Tightening & Press-fit: Jendamark Automation 76A York Road, North End 6000 Port Elizabeth Tel.: +27 41 391 4735

Asien - Asia (incl. Pacific Rim)

China	China	China	China
Shanghai Bosch Rexroth Hydraulics & Automation Ltd. No.122, Fu Te Dong Yi Road Waigaoqiao, Free Trade Zone Shanghai 200131 - P.R.China	Shanghai Bosch Rexroth Hydraulics & Automation Ltd. 4/f, Marine Tower No.1, Pudong Avenue Shanghai 200120 - P.R.China	Bosch Rexroth (China) Ltd. Satellite Service Office Changchun Rm. 1910, Guangming Building No.336 Xi'an Rd., Chao Yang Distr. Changchun 130061 - P.R.China	Bosch Rexroth (China) Ltd. Satellite Service Office Wuhan No. 22, Pinglanju, Milanyuan, Golden Harbor No. 236 Longyang Avenue Economic & Technology Development Zone Wuhan 430056 - P.R.China
Tel.: +86 21 58 66 30 30 Fax: +86 21 58 66 55 23 richard.yang@boschrexroth.com.cn gf.zhu@boschrexroth.com.cn	Tel: +86 21 68 86 15 88 Fax: +86 21 68 86 05 99 +86 21 58 40 65 77 y.wu@boschrexroth.com.cn	Tel.+Fax: +86 431 898 1129 Mobile: +86 139 431 92 659 shuhong.wang@boschrexroth.com.cn	Tel.+Fax: +86 27 84 23 23 92 Mobile: +86 139 71 58 89 67 ym.zhu@boschrexroth.com.cn
China	China	China	China
Bosch Rexroth (China) Ltd. Beijing Representative Office Xi San Qi Dong, De Sheng Mei Wai Hai Dian District Beijing 100096, P.R.China Tel.: +86 10 82 91 22 29 Fax: +86 10 82 91 81 09 van.zhang@boschrexroth.com.cn	Bosch Rexroth (China) Ltd. Guangzhou Repres. Office Room 3710-3716, Metro Plaza, Tian He District, 183 Tian He Bei Rd Guangzhou 510075, P.R.China Tel.: +86 20 87 55 00 30 +86 20 87 55 00 11 Fax: +86 20 87 55 23 87 andrew.wang@boschrexroth.com.cn	Bosch Rexroth (China) Ltd. Dalian Representative Office Room 2005, Pearl River Int. Building No.99 Xin Kai Rd., Xi Gang District Dalian, 116011, P.R.China Tel.: +86 411 83 68 26 02 Fax: +86 411 83 68 27 02 jason.tan@boschrexroth.com.cn	Tightening & Press-fit: C. Melchers GmbH & Co Shanghai Representation 13 Floor Est Ocean Centre No.588 Yanan Rd. East 65 Yanan Rd. West Shanghai 200001 Tel.: +86 21 63 52 88 48 Fax: +86 21 63 51 31 38 shermanxia@sh.melchers.com.cn
Hongkong	India - Indien	India - Indien	India - Indien
Bosch Rexroth (China) Ltd. 6 th Floor, Yeung Yiu Chung No.6 Ind Bldg. 19 Cheung Shun Street Cheung Sha Wan, Kowloon, Hongkong Tel.: +852 27 86 46 32 Fax: +852 27 42 60 57 Paul.li@boschrexroth.com.cn	Bosch Rexroth (India) Ltd. Electric Drives & Controls Plot. No.96, Phase III Peenya Industrial Area Bangalore – 560058 Tel.: +91 80 51 17 0-211...-218 Fax: +91 80 83 94 345 +91 80 83 97 374 mohanvelu.t@boschrexroth.co.in	Bosch Rexroth (India) Ltd. Electric Drives & Controls Advance House, II Floor Ark Industrial Compound Narol Naka, Makwana Road Andheri (East), Mumbai - 400 059 Tel.: +91 22 28 56 32 90 +91 22 28 56 33 18 Fax: +91 22 28 56 32 93 singh.op@boschrexroth.co.in	Tightening & Press-fit: MICO Hosur Road Adugodi 560 030 Bangalore Karnataka Tel.: +91 80 22 99 28 86
India - Indien	Indonesia - Indonesien	Japan	Japan
Bosch Rexroth (India) Ltd. S-10, Green Park Extension New Delhi – 110016 Tel.: +91 11 26 56 65 25 +91 11 26 56 65 27 Fax: +91 11 26 56 68 87 koul.rp@boschrexroth.co.in	PT. Bosch Rexroth Building # 202, Cilandak Commercial Estate Jl. Cilandak KKO, Jakarta 12560 Tel.: +62 21 7891169 (5 lines) Fax: +62 21 7891170 - 71 rudu.karimun@boschrexroth.co.id	Bosch Rexroth Automation Corp. Service Center Japan Yutakagaoka 1810, Meito-ku, NAGOYA 465-0035, Japan Tel.: +81 52 777 88 41 +81 52 777 88 53 +81 52 777 88 79 Fax: +81 52 777 89 01	Bosch Rexroth Automation Corp. Electric Drives & Controls 2F, I.R. Building Nakamachidai 4-26-44, Tsuzuki-ku YOKOHAMA 224-0041, Japan Tel.: +81 45 942 72 10 Fax: +81 45 942 03 41
Korea	Korea	Korea	Korea
Bosch Rexroth-Korea Ltd. Electric Drives & Controls 1515-14 Dadae-Dong, Saha-gu Pusan Metropolitan City, 604-050 Tel.: +82 51 26 00 741 Fax: +82 51 26 00 747 eunkyong.kim@boschrexroth.co.kr	Bosch Rexroth-Korea Ltd. Electric Drives and Controls Bongwoo Bldg. 7FL, 31-7, 1Ga Jangchoong-dong, Jung-gu Seoul, 100-391 Tel.: +82 234 061 813 Fax: +82 222 641 295	Bosch Rexroth-Korea Ltd. Electric Drives & Controls 1515-14 Dadae-Dong, Saha-gu Ulsan, 680-010 Tel.: +82 52 256-0734 Fax: +82 52 256-0738 keonhyun.jeong@boschrexroth.co.kr	Tightening & Press-fit: KVT Co., Ltd. 901, Daeryung Techno Town 8 481-11 Gasan-Dong Geumcheon-Gu Seoul, 153-775 Tel.: +82 2 2163 0231 9
Malaysia	Singapore - Singapur	Taiwan	Taiwan
Bosch Rexroth Sdn.Bhd. 11, Jalan U8/82, Seksyen U8 40150 Shah Alam Selangor, Malaysia Tel.: +60 3 78 44 80 00 Fax: +60 3 78 45 48 00 hhlim@boschrexroth.com.my rexroth1@tm.net.my	Bosch Rexroth Pte Ltd 15D Tuas Road Singapore 638520 Tel.: +65 68 61 87 33 Fax: +65 68 61 18 25 lai.ts@boschrexroth.com.sg	Bosch Rexroth Co., Ltd. Taichung Industrial Area No.19, 38 Road Taichung, Taiwan 407, R.O.C. Tel: +886 - 4 -235 08 383 Fax: +886 - 4 -235 08 586 jim.lin@boschrexroth.com.tw david.lai@boschrexroth.com.tw	Bosch Rexroth Co., Ltd. Tainan Branch No. 17, Alley 24, Lane 737 Chung Cheng N.Rd. Yungkang Tainan Hsien, Taiwan, R.O.C. Tel: +886 - 6 -253 6565 Fax: +886 - 6 -253 4754 charlie.chen@boschrexroth.com.tw
Thailand			
NC Advance Technology Co. Ltd. 59/76 Moo 9 Ramintra road 34 Tharang, Bangkhen, Bangkok 10230 Tel.: +66 2 943 70 62 +66 2 943 71 21 Fax: +66 2 509 23 62 Hotline +66 1 984 61 52 sonkawin@hotmail.com			

Nordamerika - North America

USA	USA Central Region - Mitte	USA Southeast Region - Südost	USA SERVICE-HOTLINE
Headquarters - Hauptniederlassung Bosch Rexroth Corporation Electric Drives & Controls 5150 Prairie Stone Parkway Hoffman Estates, IL 60192-3707 Tel.: +1 847 645-3600 Fax: +1 847 645-6201 servicebrc@boschrexroth-us.com repairbrc@boschrexroth-us.com	Bosch Rexroth Corporation Electric Drives & Controls 1701 Harmon Road Auburn Hills, MI 48326 Tel.: +1 248 393-3330 Fax: +1 248 393-2906	Bosch Rexroth Corporation Electric Drives & Controls 2810 Premiere Parkway, Suite 500 Duluth, GA 30097 Tel.: +1 678 957-4050 Fax: +1 678 417-6637	- 7 days x 24hrs - +1-800-REXROTH +1 800 739-7684
USA Northeast Region – Nordost Bosch Rexroth Corporation Electric Drives & Controls 99 Rainbow Road East Granby, CT 06026 Tel.: +1 860 844-8377 Fax: +1 860 844-8595	USA West Region – West Bosch Rexroth Corporation Electric Drives & Controls 7901 Stoneridge Drive, Suite 220 Pleasanton, CA 94588 Tel.: +1 925 227-1084 Fax: +1 925 227-1081		Canada East - Kanada Ost Tightening & Press-fit: Bosch Rexroth Canada Corp. 5345 Outer Drive unit 5 Windsor, Ontario Canada N9A 6J3 Tel.: +1 519 737 7393
Canada East - Kanada Ost Bosch Rexroth Canada Corporation Burlington Division 3426 Mainway Drive Burlington, Ontario Canada L7M 1A8 Tel.: +1 905 335 5511 Fax: +1 905 335 4184 michael.moro@boschrexroth.ca	Canada West - Kanada West Bosch Rexroth Canada Corporation 5345 Goring St. Burnaby, British Columbia Canada V7J 1R1 Tel.: +1 604 205 5777 Fax: +1 604 205 6944 david.gunby@boschrexroth.ca	Mexico Bosch Rexroth Mexico S.A. de C.V. Calle Neptuno 72 Unidad Ind. Vallejo 07700 Mexico, D.F. Tel.: +52 55 57 54 17 11 Fax: +52 55 57 54 50 73 mario.francioli@boschrexroth.com.mx	Mexico Bosch Rexroth S.A. de C.V. Calle Argentina No 3913 Fracc. las Torres 64930 Monterrey, N.L. Tel.: +52 81 83 65 22 53 +52 81 83 65 89 11 +52 81 83 49 80 91 Fax: +52 81 83 65 52 80

Südamerika - South America

Argentina - Argentinien	Argentina - Argentinien	Brazil - Brasilien	Brazil - Brasilien
Bosch Rexroth S.A.I.C. "The Drive & Control Company" Rosario 2302 B1606DLD Carapachay Provincia de Buenos Aires Tel.: +54 11 4756 01 40 +54 11 4756 02 40 +54 11 4756 03 40 +54 11 4756 04 40 Fax: +54 11 4756 01 36 +54 11 4721 91 53 victor.jabif@boschrexroth.com.ar	NAKASE SRL Servicio Tecnico CNC Calle 49, No. 5764/66 B1653AOX Villa Balester Provincia de Buenos Aires Tel.: +54 11 4768 36 43 Fax: +54 11 4768 24 13 Hotline: +54 11 155 307 6781 nakase@usa.net nakase@nakase.com gerencia@nakase.com (Service)	Bosch Rexroth Ltda. Av. Tégula, 888 Ponte Alta, Atibaia SP CEP 12942-440 Tel.: +55 11 4414 -56 92 +55 11 4414 -56 84 Fax sales: +55 11 4414 -57 07 Fax serv.: +55 11 4414 -56 86 alexandre.wittwer@rexroth.com.br	Bosch Rexroth Ltda. R. Dr.Humberto Pinheiro Vieira, 100 Distrito Industrial [Caixa Postal 1273] 89220-390 Joinville - SC Tel./Fax: +55 47 473 58 33 Mobil: +55 47 9974 6645 sergio.prochnow@boschrexroth.com.br
Columbia - Kolumbien Refflutec de Colombia Ltda. Calle 37 No. 22-31 Santafé de Bogotá, D.C. Colombia Tel.: +57 1 368 82 67 +57 1 368 02 59 Fax: +57 1 268 97 37 reflutec@etb.net.co			

Notes

Rexroth
Bosch Group

Bosch Rexroth AG
Electric Drives and Controls
P.O. Box 13 57
97803 Lohr, Germany
Bgm.-Dr.-Nebel-Str. 2
97816 Lohr, Germany
Phone +49 (0)93 52-40-50 60
Fax +49 (0)93 52-40-49 41
service.svc@boschrexroth.de
www.boschrexroth.com



R911314882

Printed in Germany
DOK-MTX***-SYS*DES*V04-PR01-EN-P