

**Interference Suppression  
film capacitors**

**PCX2 337  
(305V)**

**MKP RADIAL POTTED CAPACITORS**

**Pitch 10.0/15.0/22.5/27.5mm**

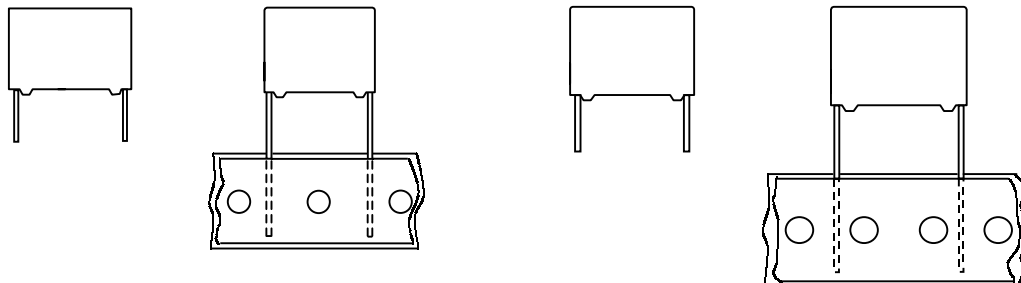

10 and 15mm

22.5 and 27.5mm

**QUICK REFERENCE DATA**

Capacitance range (E6 series) *	0.01 $\mu$ F to 3.3 $\mu$ F
Capacitance tolerance	$\pm$ 10 %, $\pm$ 20 %
Rated (AC) voltage 50 to 60 Hz	305 V <sup>-</sup>
Climatic category	40/105/21
Rated temperature	105 <sup>o</sup> C
Maximum application temperature	105 <sup>o</sup> C
Reference IEC specification	IEC 60384-14(2nd edition) and EN132400
Safety approvals	UL 1414 & CAS-C 22.2 NO.1 UL 1283 & CAS-C 22.2 NO.8 ENEC
Materials	Qualified in accordance with UL 94V-0
Safety class	X2

\* Intermediate values of the E12 series are available to special order

<p><b>FEATURES</b></p> <ul style="list-style-type: none"> <li>. 10 to 27.5 mm lead pitch</li> <li>. Supplied loose in box and taped on reel</li> <li>. Consist of a low-inductive wound cell of Metallized Polypropylene film, potted in a flame retardant case</li> </ul>	<p><b>APPLICATIONS</b></p> <ul style="list-style-type: none"> <li>. For X2-electromagnetic interference suppression</li> </ul> <p>Specially designed to meet the <b>NEW REQUIREMENTS</b> in new IEC 60384-14 specification(2nd edition)/EN 1324 requiring for X2 a 2.5kV peak pulse voltage test and the UL1414 and CSA-C22.2 No 1 specification</p>
--	--

• Please refer to caution and warning at <http://www.pilkor.co.kr/download/Introductions.pdf> before using these products.

**Ordering Information**

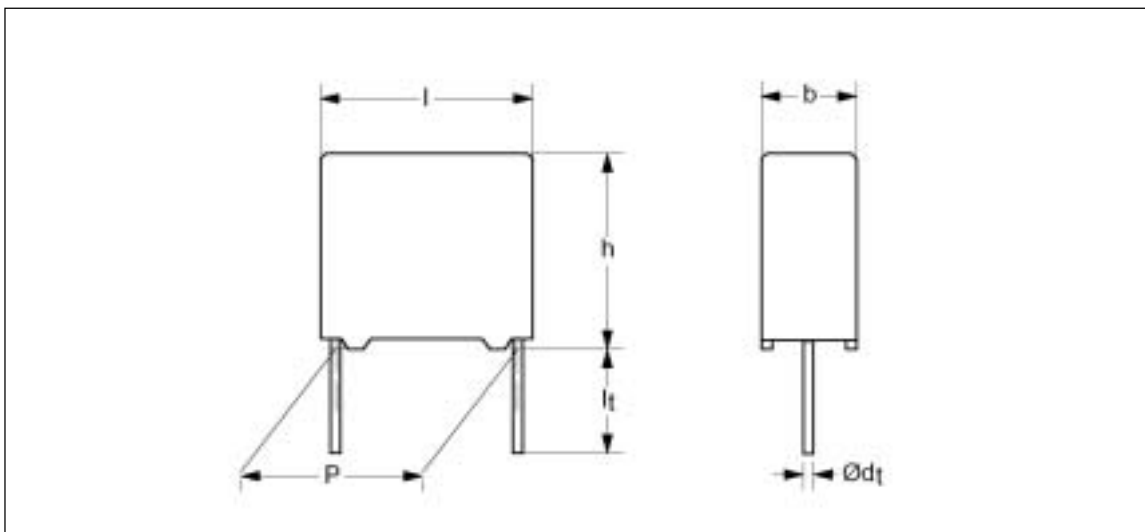

**PCX2 337 X X X X X**

Type series

Capacitance

Code	Voltage
3	305V

Code	Original pitch
D	10.0mm
F	15.0mm
J	22.5mm
L	27.5mm

code	Packing method	Lead configuration	C - tol	12NC
0	Loose in box	lt = 5.0 ± 1.0mm	C-tol ± 20 %	PCX2 337xx0xxx
1	Loose in box	lt = 5.0 ± 1.0mm	C-tol ± 10 %	PCX2 337xx1xxx
4	Loose in box	lt = 25 ± 2.0mm	C-tol ± 20 %	PCX2 337xx4xxx
5	Loose in box	lt = 25 ± 2.0mm	C-tol ± 10 %	PCX2 337xx5xxx
2	Taped on reel	H = 18.5 mm* / P <sub>0</sub> =12.7mm	C-tol ± 20%	PCX2 337xx2xxx
3	Taped on reel	H = 18.5 mm* / P <sub>0</sub> =12.7mm	C-tol ± 10%	PCX2 337xx3xxx
6	Ammopack	H = 18.5 mm* / P <sub>0</sub> =12.7mm	C-tol ± 20%	PCX2 337xx6xxx
7	Ammopack	H = 18.5 mm* / P <sub>0</sub> =12.7mm	C-tol ± 10%	PCX2 337xx7xxx
C	Loose in box	lt = 3.2 ± 0.3mm	C-tol ± 20%	PCX2 337xxCxxx
D	Loose in box	lt = 3.2 ± 0.3mm	C-tol ± 10%	PCX2 337xxDxxx

\* H ; intape height ; for detailed specifications refer to chapter PACKAGING

## Interference Suppression film capacitors

## PCX2 337 (305V)

### SAFETY APPROVALS

SAFETY APPROVALS	Voltage	Value	File Number
UL1414 & CSA C22.2 NO 1	250V(AC)	10nF to 1.0 $\mu$ F	E165646
ENEC(SEMKO) *	305V(AC)	10nF to 3.3 $\mu$ F	SE/0256-1
UL1283 & CSA C22.2 No.8	275V(AC)	C > 1 $\mu$ F	E208404

\* The ENEC-approval together with the CB-Certificate replace all national approval marks of the following countries(they have already signed the ENEC-Agreement): Austria; Belgium; Czech. Republic; Denmark; Finland; France; Germany; Greece; Hungary; Ireland; Italy; Luxembourg; Netherlands; Norway; Portugal; Slovenian; Spain; Sweden; Switzerland and United Kingdom

### Packaging Information

SMALLEST PACKING QUANTITIES (SPQ)	LOOSE IN BOX	
	lt = 5 $\pm$ 1.0 mm lt = 3.2 $\pm$ 0.3 mm	lt = 25 $\pm$ 2.0 mm
<b>DIMENSIONS</b>		
4.0 x 10.0 x 12.5	2000	1200
5.0 x 11.0 x 12.5	1500	1000
6.0 x 12.0 x 12.5	1000	1000
5.0 x 11.0 x 18.0	1000	1000
6.0 x 12.0 x 18.0	1000	1000
7.0 x 13.5 x 18.0	1000	1000
8.5 x 15.0 x 18.0	1000	1000
10.0 x 16.5 x 18.0	1000	1000
11.0 x 18.5 x 18.0	1000	1000
6.0 x 15.5 x 26.0	1000	1000
7.0 x 16.5 x 26.0	1000	1000
8.5 x 18.0 x 26.0	500	500
10.0 x 19.5 x 26.0	500	500
13.0 x 23.0 x 26.0	500	500
11.0 x 21.0 x 31.0	500	250
13.0 x 23.0 x 31.0	250	250
15.0 x 25.0 x 31.0	250	250
18.0 x 28.0 x 31.0	200	200
21.0 x 31.0 x 31.0	150	150

# Interference Suppression film capacitors

# PCX2 337 (305V)

**SPECIFIC REFERENCE DATA FOR 305 V<sub>AC</sub>**

Tangent of loss angle	at 1 khz	at 10 khz
C 470 nF 470 nF < C 1 μF C > 1 μF	$10 \times 10^{-4}$ $20 \times 10^{-4}$ $30 \times 10^{-4}$	$20 \times 10^{-4}$ $70 \times 10^{-4}$ -
Rated voltage pulse slope (dV/dt) <sub>R</sub>	100 V/μs	
R between leads, for C 0.33 μF	15 000 MΩ	
RC between leads, for C > 0.33 μF	5 000 s	
Test voltage (DC) on line; C 1 μF C > 1 μF	2250 V ; 1 min 1850 V ; 1 min	

**V<sub>Rac</sub> = 305 V X2**
**loose and taped**

Cap. (μF)	b x h x l (mm)	MASS (g)	CATALOGUE NUMBER			
			PCX2 337 .....			
			loose in box			
			lt = 5 ± 1.0 mm		lt = 25 ± 2.0 mm	
			C - tol. ±20 %	C - tol. ±10 %	C - tol. ±20 %	C - tol. ±10 %
Pitch = 10.0 ± 0.4 mm			dt = 0.6 +0.06/-0.05 mm			
0.01	4.0 x 10.0 x 12.5	0.8	D30103	D31103	D34103	D35103
0.015	4.0 x 10.0 x 12.5	0.8	D30153	D31153	D34153	D35153
0.022	4.0 x 10.0 x 12.5	0.8	D30223	D31223	D34223	D35223
0.033	5.0 x 11.0 x 12.5	0.9	D30333	D31333	D34333	D35333
0.047	5.0 x 11.0 x 12.5	0.9	D30473	D31473	D34473	D35473
0.068	6.0 x 12.0 x 12.5	1.0	D30683	D31683	D34683	D35683
0.1	6.0 x 12.0 x 12.5	1.0	D30104	D31104	D34104	D35104

**Interference Suppression  
film capacitors**
**PCX2 337  
(305V)**
 $V_{Rac} = 305 V \cdot X2$ 

loose and taped

Cap. ( $\mu F$ )	b x h x l (mm)	MASS (g)	CATALOGUE NUMBER			
			PCX2 337 .....			
			loose in box			
			lt = 5 $\pm$ 1.0 mm		lt = 25 $\pm$ 2.0 mm	
			C - tol. $\pm 20$ %	C - tol. $\pm 10$ %	C - tol. $\pm 20$ %	C - tol. $\pm 10$ %
Pitch = 15.0 $\pm$ 0.4 mm			dt = 0.6 +0.06/-0.05 mm			
0.01	5.0 x 11.0 x 18.0	1.6	F30103	F31103	F34103	F35103
0.015	5.0 x 11.0 x 18.0	1.6	F30153	F31153	F34153	F35153
0.022	5.0 x 11.0 x 18.0	1.6	F30223	F31223	F34223	F35223
0.033	5.0 x 11.0 x 18.0	1.6	F30333	F31333	F34333	F35333
0.047	5.0 x 11.0 x 18.0	1.6	F30473	F31473	F34473	F35473
0.068	5.0 x 11.0 x 18.0	1.6	F30683	F31683	F34683	F35683
0.1*	5.0 x 11.0 x 18.0	1.6	FV0104	FV1104	FV4104	FV5104
Pitch = 15.0 $\pm$ 0.4 mm			dt = 0.8 +0.08/-0.05 mm			
0.1	6.0 x 12.0 x 18.0	1.8	F30104	F31104	F34104	F35104
0.15	7.0 x 13.5 x 18.0	1.9	F30154	F31154	F34154	F35154
0.22	8.5 x 15.0 x 18.0	2.6	F30224	F31224	F34224	F35224
0.33	10.0 x 16.5 x 18.0	3.1	F30334	F31334	F34334	F35334
0.47	11.0 x 18.5 x 18.0	4.1	F30474	F31474	F34474	F35474
Pitch = 22.5 $\pm$ 0.4 mm			dt = 0.8 +0.08/-0.05 mm			
0.22	6.0 x 15.5 x 26.0	3.0	J30224	J31224	J34224	J35224
0.33	7.0 x 16.5 x 26.0	3.5	J30334	J31334	J34334	J35334
0.47	8.5 x 18.0 x 26.0	4.4	J30474	J31474	J34474	J35474
0.68	10.0 x 19.5 x 26.0	5.5	J30684	J31684	J34684	J35684
1.0	13.0 x 23.0 x 26.0	8.0	J30105	J31105	J34105	J35105
Pitch = 27.5 $\pm$ 0.4 mm			dt = 0.8 +0.08/-0.05 mm			
0.68	11.0 x 21.0 x 31.0	11.0	L30684	L31684	L34684	L35684
1.0	13.0 x 23.0 x 31.0	11.5	L30105	L31105	L34105	L35105
1.5	15.0 x 25.0 x 31.0	12.8	L30155	L31155	L34155	L35155
2.2	18.0 x 28.0 x 31.0	17.2	L30225	L31225	L34225	L35225
3.3	21.0 x 31.0 x 31.0	20.4	L30335	L31335	L34335	L35335

\* Mini Type : xVxxxx

**CONSTRUCTION**

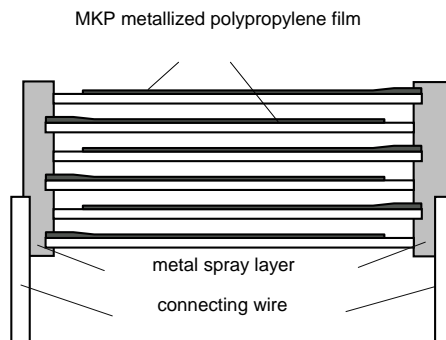

**MOUNTING**

**NORMAL USE**

The capacitors are designed for mounting on printed-circuit boards.  
 The capacitors packed in bandoliers are designed for mounting on printed-circuit boards by means of automatic insertion machines.  
 For detailed specifications refer to chapter "PACKAGING".

**SPECIFIC METHOD OF MOUNTING TO WITHSTAND VIBRATION AND SHOCK**

In order to withstand vibration and shock tests, it must be ensured that the stand-off pips are in good contact with the printed-circuit board.  
 . For pitches of 15mm the capacitors shall be mechanically fixed by leads.  
 . For larger pitches the capacitors shall be mounted in the same way and the body clamped.

**SPACE REQUIREMENTS ON PRINTED-CIRCUIT BOARD**

The maximum length and width of film capacitors are shown in the following drawing ;

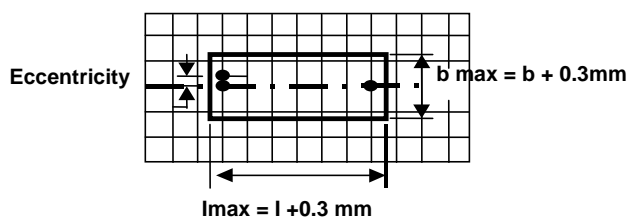

- Eccentricity as in drawing.  
 The maximum eccentricity is smaller than or equal to the lead diameter of the product concerned.
- Product height with seating plane as given by IEC 60717 as reference :  $h_{max} \quad h+0.3mm$

**RATINGS AND CHARACTERISTICS**

Unless otherwise specified all electrical values apply to an ambient temperature of  $23 \pm 1$  °C, an atmospheric pressure of 86 to 106kPa and a relative humidity  $50 \pm 2\%$ .

For reference testing, a conditioning period shall be applied of  $96 \pm 4$  hours by heating the products in a circulating air oven at the rated temperature and a relative humidity not exceeding 20%.

**Maximum RMS Voltage as a function of frequency**

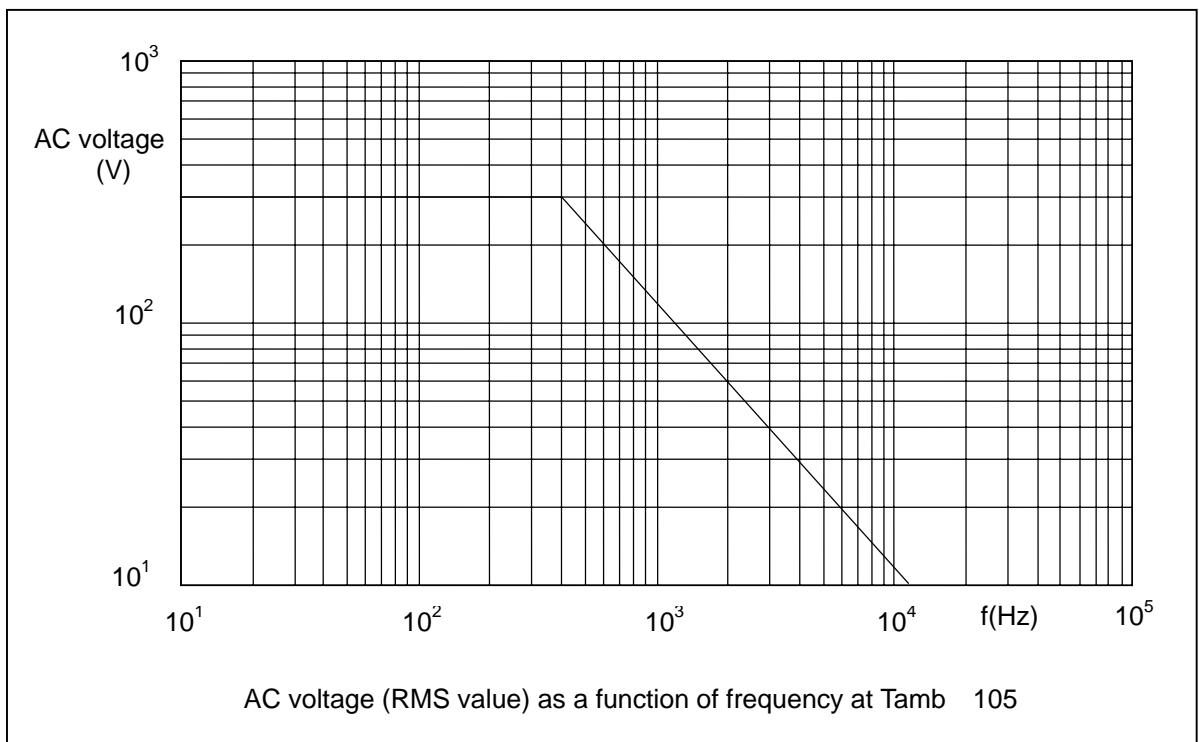

**PRODUCT MARKING**

Capacitors are marked with having following information;

- 1.Manufacturer (PILKOR)
- 2.Manufacturer's type designation (337 or PCX2 337)
- 3.Rated capacitance in code according to IEC 60062
- 4.Rated (AC) voltage (305V~)
- 5.Sub class (X2)
- 6.Tolerance on rated capacitance M = ± 20 % K = ± 10 %
- 7.Climatic category (40/105/21)
- 8.Code for dielectric material (MKP)
- 9.Year and week of manufacturing (0638)
- 10.Safety approvals

Example of marking

Pitch P = 10mm



Marking on the side

Pitch P = 15.0mm or P = 22.5mm

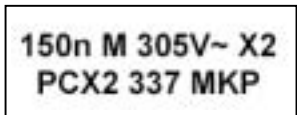

Marking on the top



Marking on the side

Pitch P = 22.5 mm.

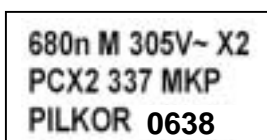

Marking on the top



Marking on the side

or



Marking on headface

Pitch P = 27.5 mm.



Marking on headface(C = 1uF)

or

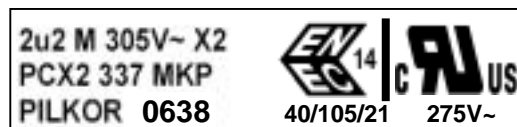

Marking on headface(C > 1uF)