

### STANDARD DIODES

### ADD-A-pak™ GEN V Power Modules

#### Features

- High Voltage
- Industrial Standard Package
- Thick Al metal die and double stick bonding
- Thick copper baseplate
- UL E78996 approved
- 3500V<sub>RMS</sub> isolating voltage

#### Benefits

- Up to 1600V
- Full compatible TO-240AA
- High Surge capability
- Easy Mounting on heatsink
- Al<sub>2</sub>O<sub>3</sub> DBC insulator
- Heatsink grounded

100 A

#### Mechanical Description

The Generation V of Add-A-pak module combine the excellent thermal performance obtained by the usage of Direct Bonded Copper substrate with superior mechanical ruggedness, thanks to the insertion of a solid Copper baseplate at the bottom side of the device.

The Cu baseplate allow an easier mounting on the majority of heatsink with increased tolerance of surface roughness and improve thermal spread.

The Generation V of AAP module is manufactured without hard mold, eliminating in this way any possible direct stress on the leads.

The electrical terminals are secured against axial pull-out: they are fixed to the module housing via a click-stop feature already tested and proved as reliable on other IR modules.

#### Electrical Description

These modules are intended for general purpose high voltage applications such as high voltage regulated power supplies, lighting circuits, temperature and motor speed control circuits, UPS and battery charger.

#### Major Ratings and Characteristics

Parameters	IRK.91	Units
$I_{F(AV)}$	100	A
@ $T_C$	100	°C
$I_{F(RMS)}$	157	A
$I_{FSM}$ @ 50Hz	2020	A
@ 60Hz	2110	A
$I^2t$ @ 50Hz	20.43	KA <sup>2</sup> s
@ 60Hz	18.65	KA <sup>2</sup> s
$I^2\sqrt{t}$	204.3	KA <sup>2</sup> √s
$V_{RRM}$ range	400 to 1600	V
$T_J$	-40 to 150	°C
$T_{STG}$	-40 to 150	°C



## IRK.91 Series

Bulletin I27141 rev. F 10/02

International  
IR Rectifier

### ELECTRICAL SPECIFICATIONS

#### Voltage Ratings

Type number	Voltage Code	$V_{RRM}$ , maximum repetitive peak reverse voltage V	$V_{RSM}$ , maximum non-repetitive peak rev. voltage V	$I_{RRM}$ max. @ $T_J = 150^\circ\text{C}$ mA
IRK.91	04	400	500	10
	06	600	700	
	08	800	900	
	10	1000	1100	
	12	1200	1300	
	14	1400	1500	
	16	1600	1700	

#### Forward Conduction

Parameter	IRK.91	Units	Conditions
$I_{F(AV)}$ Max. average forward current @ Case temperature	100	A	180° conduction, half sine wave
	100	°C	
$I_{F(AV)}$ Max. average forward current @ Case temperature	90	A	180° conduction, half sine wave
	107	°C	
$I_{F(RMS)}$ Max. RMS forward current	157	A	DC @ 90°C case temperature
$I_{FSM}$ Max. peak, one-cycle forward, non-repetitive surge current	2020	A	t = 10ms No voltage
	2110		t = 8.3ms reapplied
	1700		t = 10ms 100% $V_{RRM}$
	1780		t = 8.3ms reapplied
$I^2t$ Maximum $I^2t$ for fusing	20.43	KA <sup>2</sup> s	t = 10ms No voltage
	18.65		t = 8.3ms reapplied
	14.45		t = 10ms 100% $V_{RRM}$
	13.19		t = 8.3ms reapplied
$I^2\sqrt{t}$ Maximum $I^2\sqrt{t}$ for fusing	204.3	KA <sup>2</sup> √s	t = 0.1 to 10ms, no voltage reapplied
$V_{F(TO)1}$ Low level value of threshold voltage	0.79	V	( $16.7\% \times \pi \times I_{F(AV)} < I < \pi \times I_{F(AV)}$ ), $T_J = T_J$ max.
$V_{F(TO)2}$ High level value of threshold voltage	0.87		( $I > \pi \times I_{F(AV)}$ ), $T_J = T_J$ max.
$r_{f1}$ Low level value of forward slope resistance	1.78	mΩ	( $16.7\% \times \pi \times I_{F(AV)} < I < \pi \times I_{F(AV)}$ ), $T_J = T_J$ max.
$r_{f2}$ High level value of forward slope resistance	1.57		( $I > \pi \times I_{F(AV)}$ ), $T_J = T_J$ max.
$V_{FM}$ Max. forward voltage drop	1.45	V	$I_{FM} = \rho \times I_{F(AV)}$ , $T_J = 25^\circ\text{C}$ , $t_p = 400\mu\text{s}$ square wave

#### Blocking

Parameter	IRK.91	Units	Conditions
$I_{RRM}$ Max. peak reverse leakage current	10	mA	$T_J = 150^\circ\text{C}$
$V_{INS}$ RMS isolation voltage	3500 (1 sec)	V	50 Hz, circuit to base, all terminals shorted

### Thermal and Mechanical Specifications

Parameter	IRK.91	Units	Conditions
T <sub>J</sub> Max. junction operating temperature range	-40 to 150	°C	
T <sub>stg</sub> Storage temperature range	-40 to 150		
R <sub>thJC</sub> Max. thermal resistance, junction to case	0.35	K/W	Per junction, DC operation
R <sub>thCS</sub> Typical thermal resistance, case to heatsink	0.1		Mounting surface flat, smooth and greased
T Mounting torque ±10%	to heatsink	5	A mounting compound is recommended and the torque should be rechecked after a period of 3 hours to allow for the spread of the compound
	busbar	4	
wt Approximate weight	110 (4)	g (oz)	
Case style	TO-240AA	JEDEC	

### ΔR Conduction (per Junction)

(The following table shows the increment of thermal resistance R<sub>thJC</sub> when devices operate at different conduction angles than DC)

Devices	Sine half wave conduction					Rect. wave conduction					Units
	180°	120°	90°	60°	30°	180°	120°	90°	60°	30°	
IRK.91	0.052	0.064	0.082	0.112	0.164	0.043	0.069	0.088	0.115	0.165	°C/W

### Ordering Information Table

Device Code					
IRK	D	91	/	16	A
①	②	③		④	⑤
<b>1</b>	- Module type				
<b>2</b>	- Circuit configuration (See Circuit Configuration Table)				
<b>3</b>	- Current code				
<b>4</b>	- Voltage code (See Voltage Ratings Table)				
<b>5</b>	- A: Gen V				

# IRK.91 Series

Bulletin I27141 rev. F 10/02

## Outline Table

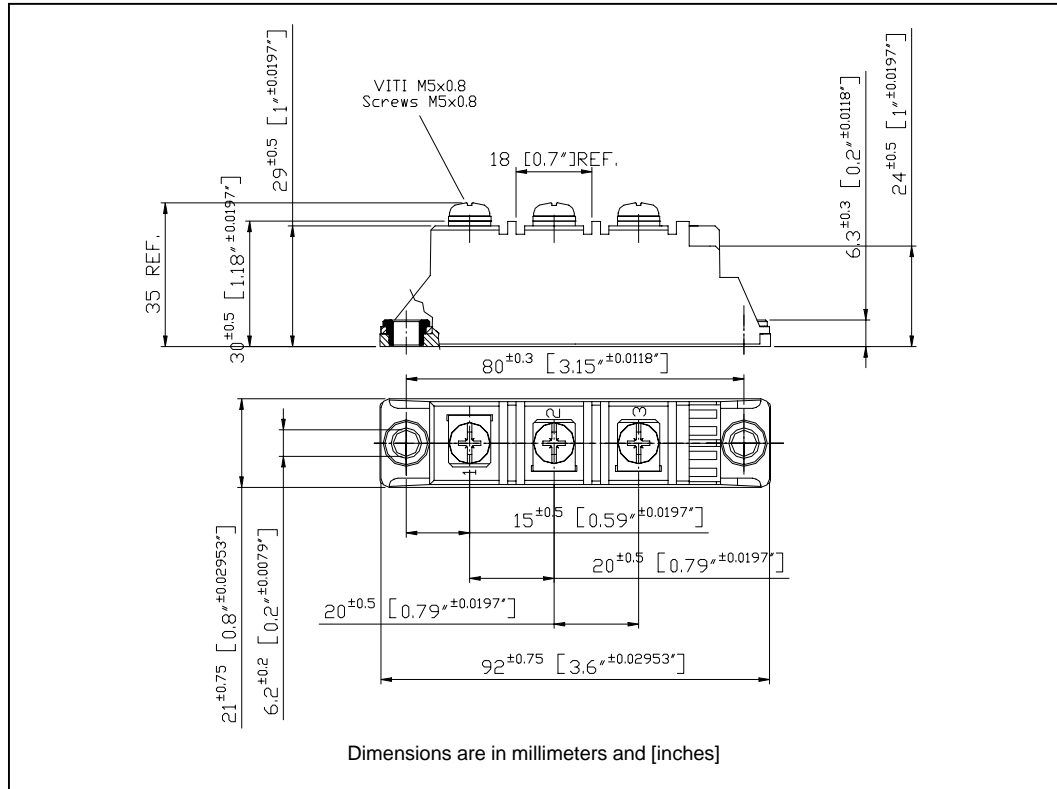

## Circuit Configuration Table

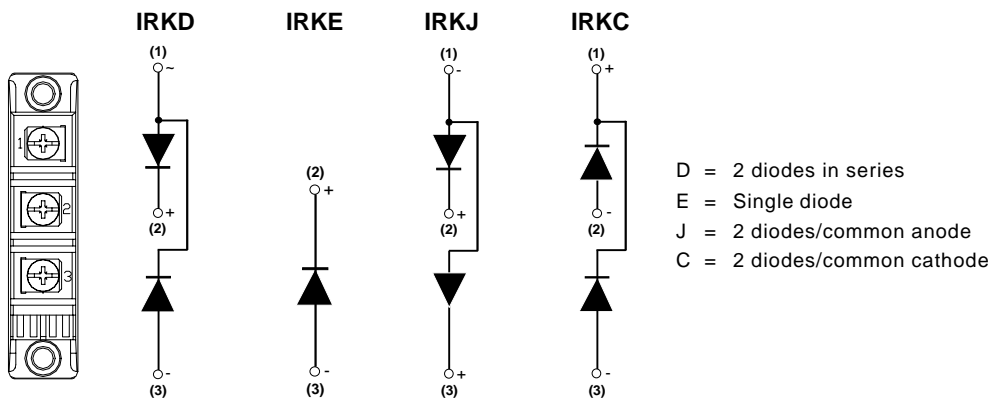

**NOTE:** To order the Optional Hardware see Bulletin I27900

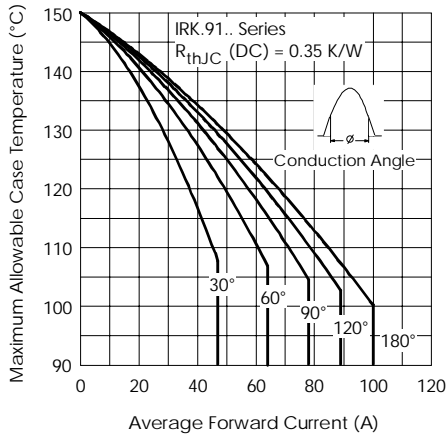

Fig. 1 - Current Ratings Characteristics

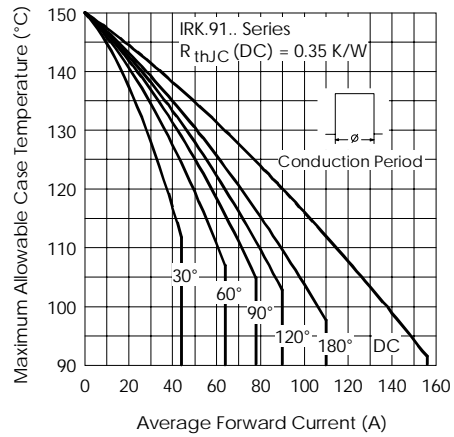

Fig. 2 - Current Ratings Characteristics

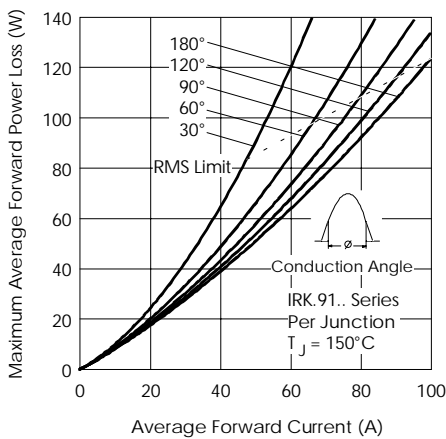

Fig. 3 - Forward Power Loss Characteristics

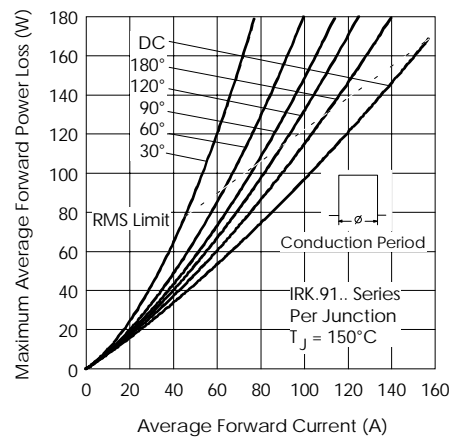

Fig. 4 - Forward Power Loss Characteristics

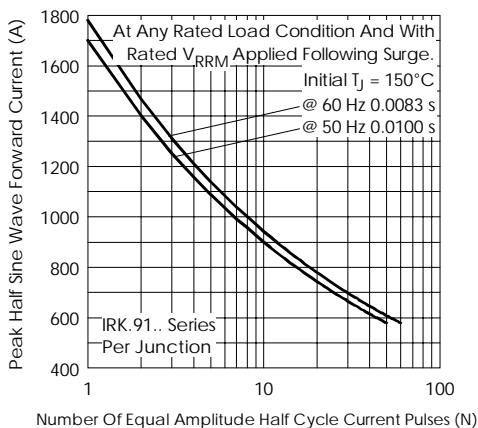

Fig. 5 - Maximum Non-Repetitive Surge Current

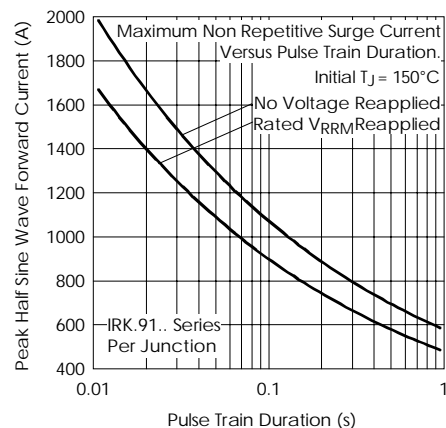

Fig. 6 - Maximum Non-Repetitive Surge Current

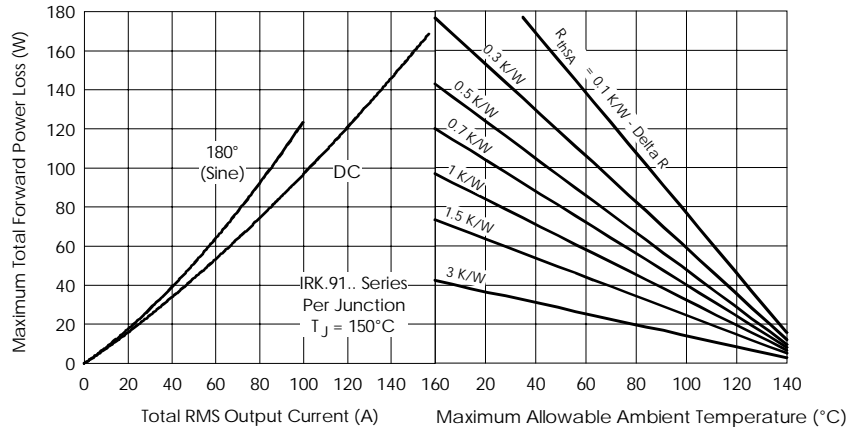

Fig. 7 - Forward Power Loss Characteristics

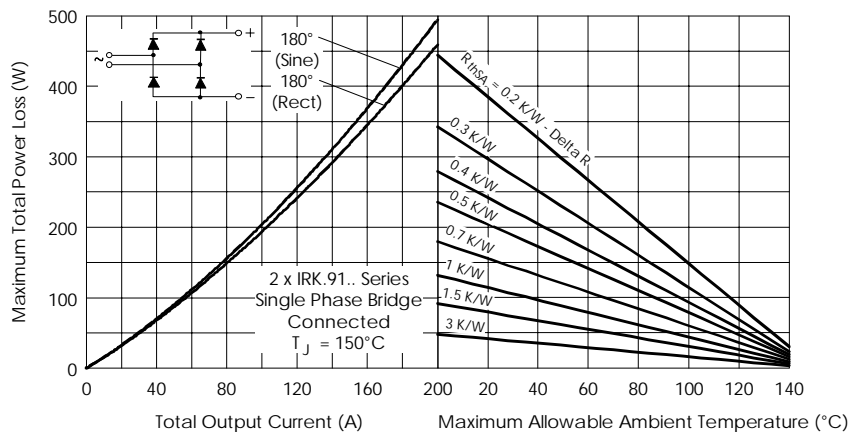

Fig. 8 - Forward Power Loss Characteristics

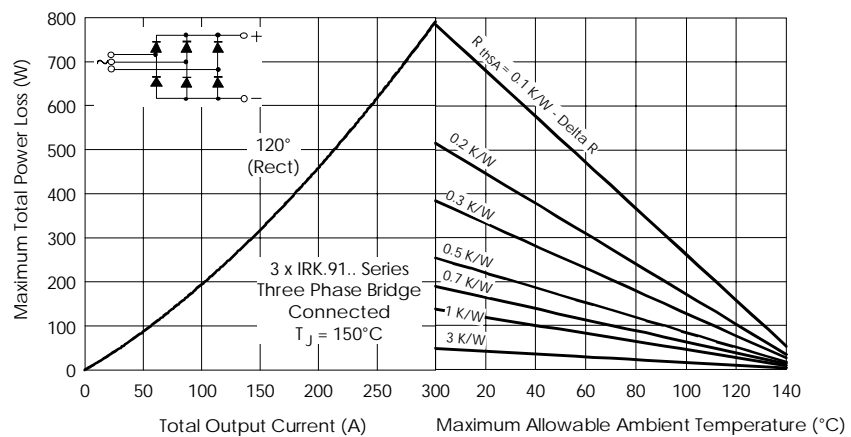

Fig. 9 - Forward Power Loss Characteristics

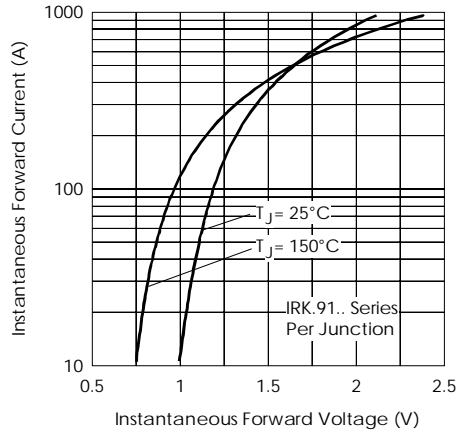

Fig. 10 - Forward Voltage Drop Characteristics

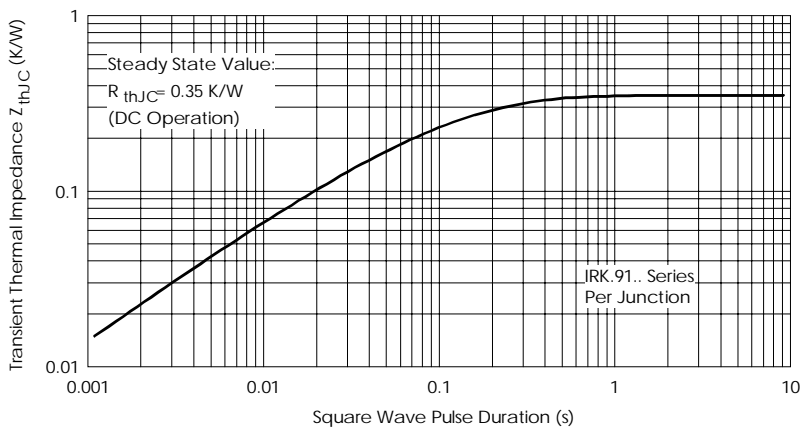

Fig. 11 - Thermal Impedance  $Z_{thJC}$  Characteristic

Data and specifications subject to change without notice.  
This product has been designed and qualified for Industrial Level.  
Qualification Standards can be found on IR's Web site.

This datasheet has been download from:

[www.datasheetcatalog.com](http://www.datasheetcatalog.com)

Datasheets for electronics components.