

IRA-S230ST01

In Production

Recommended

RoHS

REACH

Appearance & Shape

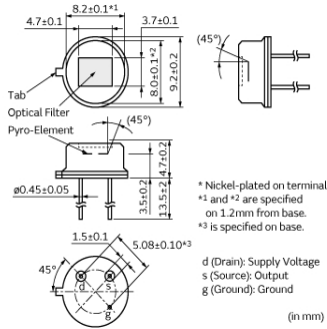

Features

Excellent Sensitivity & S/N ratio (Signal/Noise)
Excellent Quality

Applications

Other Usage	Not available for Automotive usage.
-------------	-------------------------------------

Packaging Information

Packaging	Specifications	Minimum Order Quantity
-	Box	100

Attention
1.This datasheet is downloaded from the website of Murata Manufacturing Co., Ltd. Therefore, it's specifications are subject to change or our products in it may be discontinued without advance notice. Please check with our sales representatives or product engineers before ordering.
2.This datasheet has only typical specifications because there is no space for detailed specifications.
Therefore, please review our product specifications or consult the approval sheet for product specifications before ordering.

IRA-S230ST01

Specifications

Operating Temperature Range	-40°C to 70°C
Shape	Lead
Field of View	theta1=theta2=45deg.
Electrode	(2.0x1.0mm)x2
Responsivity(typ.)	4.6mV
Optical Filter	5micro meter Long Pass
Supply Voltage Range	2V to 15V
Storage Temperature Range	-40°C to 85°C

Attention

1.This datasheet is downloaded from the website of Murata Manufacturing Co., Ltd. Therefore, it's specifications are subject to change or our products in it may be discontinued without advance notice. Please check with our sales representatives or product engineers before ordering.

2.This datasheet has only typical specifications because there is no space for detailed specifications.

Therefore, please review our product specifications or consult the approval sheet for product specifications before ordering.

IRA-S230ST01

Product Data

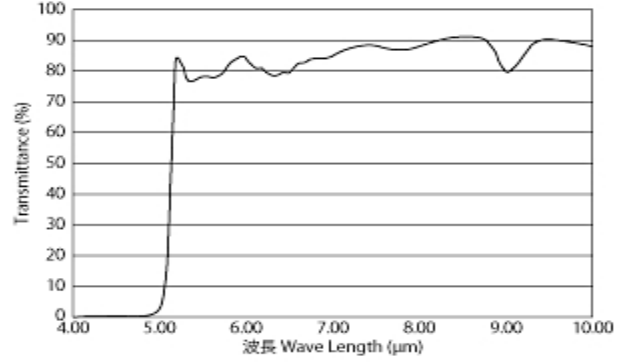
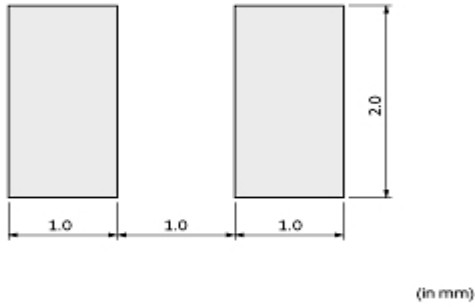

Pyroelectric Element

Filter characteristics

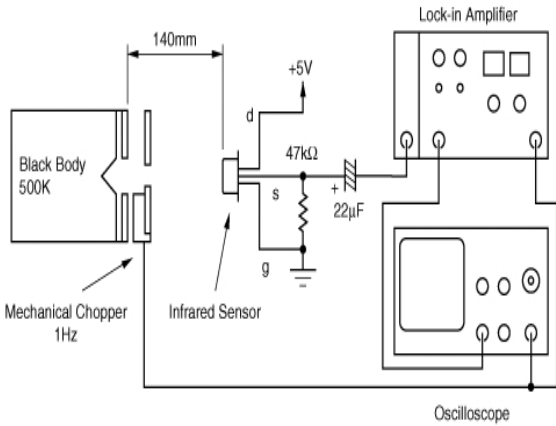

Test circuit

Attention

- 1.This datasheet is downloaded from the website of Murata Manufacturing Co., Ltd. Therefore, it's specifications are subject to change or our products in it may be discontinued without advance notice. Please check with our sales representatives or product engineers before ordering.
- 2.This datasheet has only typical specifications because there is no space for detailed specifications.
Therefore, please review our product specifications or consult the approval sheet for product specifications before ordering.