

SINUMERIK System 3

Service Manual

Part 1
for Versions 0 through 3:
for Model 0 to 2: Up to Software edition 09
for Model 3: Up to Software edition 05

Edition 12/85

Siemens Corporation

| | |
|--|----|
| Start-up Check List | 1 |
| Lists and Tables | 2 |
| Prerequisites and Visual Checks | 3 |
| Voltage and Function Tests Erasing the Memories Machine Data Input | 4 |
| Standard Start-up | 5 |
| Drive Adjustment | 6 |
| Machine Data Description | 7 |
| Interface | 8 |
| Board Overview and Strappings | 9 |
| Engineering Panel and Test Boards | 10 |
| PC Information | 11 |
| Modifying PC Programs via the NC Operator Panel with Test Boards | 12 |
| Alarm Description | 13 |
| Version 0 Notes and Start-up Information | 14 |
| | 15 |
| | 16 |

Key to editions

The editions listed below have appeared prior to the present issue.

The "Revisions" column contains a list of the sections which have been revised, in each case with reference to this present edition.

| <u>Edition</u> | <u>Ordern-No.</u> | <u>Revisions</u> |
|----------------|----------------------|------------------|
| A.12.85 | E80210-T147-X-A-7600 | --- |

Table of contents

Page

| | | |
|-------|--|------|
| 1 | Start-up Check List | 1-1 |
| 1.1 | Check List | 1-1 |
| 1.2 | Machine Data | 1-3 |
| 1.3 | Options available according to shipping notice | 1-11 |
| 1.4 | Jumpers on the I/O Boards | 1-15 |
| 2 | Lists and Tables | 2-1 |
| 2.1 | Standard Machine Data Bits | 2-1 |
| 2.2 | Machine Data List with Standard Machine Data Axis-Specific Machine Data (Test) | 2-2 |
| 2.3 | Machine Data Bits (Test) | 2-5 |
| 2.4 | Display (Test) | 2-9 |
| 2.5 | Setting Data: For Versions 0 and 2 | 2-10 |
| 2.5.1 | Input and Display: Zero Offset, S-max., M19 Setting Data and R-Parameters | 2-10 |
| 2.5.2 | Setting Data Bits (Operator Data) | 2-10 |
| 2.6 | Setting Data for Version 3 | 2-11 |
| 2.6.1 | Display and Input Zero Offset, S-max, M19 Setting Data Bits and R-Parameters | 2-11 |
| 2.6.2 | Setting Data Bits Nr. 25 (Operator Data) | 2-11 |
| 2.6.3 | Setting Data Bits Nr. 26 (Operator Data) | 2-12 |
| 2.7 | Alarm List | 2-13 |
| 2.8 | Interface Signals | 2-15 |
| 3 | Prerequisites and Visual Checks | 3-1 |
| 3.1 | Preliminary Remarks | 3-1 |
| 3.2 | Prerequisites, which must be met by the customer before Start-up: | 3-3 |
| 3.3 | Supply Voltages | 3-4 |
| 3.3.1 | Power Supply Components | 3-4 |
| 3.3.2 | Line Conditions | 3-4 |
| 3.3.3 | Power Supply Connection-Logic Components | 3-5 |
| 3.3.4 | Line Connection for Fans | 3-6 |
| 3.3.5 | Operator Panel Power Supply | 3-6 |
| 3.3.6 | Machine Control Panel 03 630 | 3-7 |
| 3.4 | Visual Inspection | 3-8 |
| 3.4.1 | Grounding | 3-8 |

| | | |
|-------|--|------|
| 3.4.2 | Position Coders | 3-8 |
| 3.4.3 | Cabling | 3-8 |
| 3.4.4 | Shielding | 3-8 |
| 3.4.5 | Operator Panel | 3-8 |
| 3.4.6 | General State | 3-8 |
| 3.4.7 | Battery in Power Supply | 3-9 |
| 3.4.8 | Cables | 3-9 |
| 3.5 | NC-Boards and Strappings | 3-10 |
| 3.5.1 | Identification System and Generalities | 3-10 |
| 3.5.2 | Logic Component Assembly | 3-11 |
| 3.5.3 | Strappings | 3-15 |
| 3.5.4 | Other SINUMERIK Input and Output Boards | 3-15 |
| 3.5.5 | SIMATIC S5 Input and Output Boards | 3-15 |
| 3.6 | Software System | 3-15 |
| 3.6.1 | Executive Software | 3-15 |
| 3.6.2 | SINUMERIK System 3 - Software Designation System | 3-16 |
| 3.6.3 | Operating System Version 0 and 2 | 3-18 |
| 3.6.4 | Diagnostic System Version 0 and 2 | 3-18 |
| 3.6.5 | Operating System Version 3 | 3-19 |
| 3.6.6 | Diagnostic System Version 3 | 3-21 |
| 3.6.7 | PC-Diagnostic System for Version 3 | 3-21 |
| 3.7 | Remarks Concerning Version 1 | 3-22 |
| 3.8 | Remarks Concerning Version 0 and 2 with Software Edition 04 | 3-22 |
| 4 | Voltage and Function Test, Erasing the Memories, Machine Data Input | 4-1 |
| 4.1 | Voltage Test | 4-2 |
| 4.1.1 | Voltage Supply | 4-2 |
| 4.1.2 | Power-up Phase | 4-2 |
| 4.1.3 | Fuses | 4-2 |
| 4.1.4 | DC Voltage | 4-3 |
| 4.1.5 | Error Storage while the NC is Switched Off | 4-3 |
| 4.2 | Function Test | 4-3 |
| 4.2.1 | CPU Cycle Monitoring on PC Board 03100 at Power-up | 4-3 |
| 4.2.2 | CPU Cycle Monitoring during Operation | 4-4 |
| 4.2.3 | Check SUM Test of the System Program Memory | 4-4 |
| 4.2.4 | Adjusting the CRT Brightness in Version 3 | 4-5 |
| 4.2.5 | Remarks Concerning the CRT in Version 3 | 4-5 |
| 4.2.6 | Emergency-stop and Limit-switch Test | 4-5 |

| | | |
|-------|--|------|
| 4.3 | Clearing the Memory Ranges (Cancel) | 4-5 |
| 4.3.1 | Cancel 0 | 4-6 |
| 4.3.2 | Cancel 2 | 4-6 |
| 4.3.3 | Cancel 3 | 4-6 |
| 4.3.4 | Cancel 4 | 4-7 |
| 4.4 | Loading the Standard Machine Data | 4-7 |
| 4.5 | Establishing the Control Type without Changing the Machine Data | 4-7 |
| 4.6 | General Information Concerning the Input of Machine and Setting Data | 4-8 |
| 4.7 | Constructing and Handling the Machine Data Tape | 4-10 |
| 4.7.1 | Constructing the Machine Data Tape | 4-10 |
| 4.7.2 | Preparing for Reading the Tape | 4-10 |
| 4.7.3 | Loading the Machine Data Tape | 4-11 |
| 4.8 | Example of Machine Data of a Lathe | 4-12 |
| 5 | Manual Start-up with System Software | 5-1 |
| 5.1 | Machine Data | 5-1 |
| 5.2 | Control Polarity of Feed Axes | 5-1 |
| 5.3 | Closing the Velocity Control Loop | 5-3 |
| 5.4 | Manual Run | 5-4 |
| 5.5 | Drift Compensation | 5-5 |
| 5.6 | Testing all Manual Functions | 5-5 |
| 5.7 | Running a Program | 5-6 |
| 6 | Drive Optimization, Drive Monitor and Finishing Touches | 6-1 |
| 6.1 | Tacho Adjustment and Definition of the Maximum Command Value | 6-1 |
| 6.2 | Mult-gain Factor | 6-2 |
| 6.3 | Position Control Loop Gain (Kv Factor) | 6-4 |
| 6.4 | Acceleration TEST Nr. 120-123 | 6-7 |
| 6.5 | Cut-off Velocity | 6-8 |
| 6.6 | Position Monitors | 6-9 |
| 6.7 | Contour Monitouring | 6-10 |
| 6.8 | Analogue Spindle Speed | 6-13 |
| 6.9 | Finishing Touches | 6-15 |
| 6.9.1 | Function Tests with NC Test Program | 6-15 |
| 6.9.2 | Generating a Machine Data Test | 6-16 |

| | | |
|--------|--|------|
| 6.9.3 | Machine Data Tape with Machine Standard Data | 6-16 |
| 6.9.4 | Brief Instruction to the Customer | 6-17 |
| 6.9.5 | Start-up Report | 6-17 |
| 6.9.6 | Scheck-list for the Log Book | 6-17 |
| 7 | Machine Data Description | 7-1 |
| 7.1 | Generalities | 7-3 |
| 7.2 | Axis-specific Machine Data | 7-3 |
| 7.3 | Common Machine Data | 7-18 |
| 7.4 | Machine Data Bits Description | 7-39 |
| 7.4.1 | Address Designations | 7-39 |
| 7.4.2 | Time Settings | 7-40 |
| 7.4.3 | Reference Point Approach Direction | 7-41 |
| 7.4.4 | Sign Change for Velocity Command Value Partial, Actual Value | 7-41 |
| 7.4.5 | Multiplication Factor for the Partial Actual Value | 7-42 |
| 7.4.6 | Rotary Axis | 7-44 |
| 7.4.7 | Exclude the Axis in the Start Interlock | 7-44 |
| 7.4.8 | Spindle with ROD-Error | 7-44 |
| 7.4.9 | Speed in 0,1 rpm, N407 B | 7-44 |
| 7.4.10 | Reference Point | 7-45 |
| 7.4.11 | Auxiliary Function Output | 7-46 |
| 7.4.12 | Evaluation of the Programmed Data with S-analog | 7-46 |
| 7.4.13 | Position Control Feed-back and Input System, Metric/Inch | 7-47 |
| 7.4.14 | No Deceleration at Limit Switch | 7-48 |
| 7.4.15 | Tool Length Compensation for non-programed Axis (only for 3T) | 7-50 |
| 7.4.16 | -- | |
| 7.4.17 | Diameter Programing (only for 3T) | 7-51 |
| 7.4.18 | PC-Present | 7-51 |
| 7.4.19 | Handwheel Present | 7-51 |
| 7.4.20 | Feed Rate not on the Contour | 7-51 |
| 7.4.21 | Option 2nd. Input/Output Board | 7-51 |
| 7.4.22 | NC-PC Interface Activation | 7-52 |
| 7.4.23 | Key Switch Active for Operating Modes | 7-52 |
| 7.4.24 | I/O Interface V24 (RS 232 C) | 7-53 |
| 7.4.25 | EIA Code for @ Sign (A) | 7-53 |

| | | |
|--------|---|------|
| 7.4.25 | Name of Main Axis Associated (B) | 7-53 |
| 7.4.25 | DC Control Character without Parity (C) | 7-53 |
| 7.4.26 | Option Bits | 7-54 |
| 7.4.27 | Actual Values of X-Axis at 3T Displayed in Diameter | 7-55 |
| 7.4.28 | Block End with Carriage Return and Line Feed | 7-55 |
| 7.4.29 | 14 Bit DAC | 7-55 |
| 7.4.30 | Wear Input in Diameter | 7-55 |
| 7.4.31 | Spindle Override Active in Threading | 7-55 |
| 7.4.32 | Deceleration to the Velocity of the Next Block | 7-56 |
| 7.4.33 | Test Bits | 7-56 |
| 7.4.34 | Display Bits | 7-56 |
| 8 | Interface Text | 8-1 |
| 8.1 | Signal Display | 8-1 |
| 8.2 | Pin-Layout of the Input and Output Connectors | 8-3 |
| 8.3 | Code Tables | 8-4 |
| 8.3.1 | Operating Mode Selector Switch (Gray-coded) S15 | 8-4 |
| 8.3.2 | Axis Selector Switch S18 | 8-5 |
| 8.3.3 | Feed Override Switch (Gray-coded) S17 | 8-5 |
| 8.3.4 | Spindle Override Switch (Gray-coded) S16 | 8-6 |
| 8.3.5 | Gear ranges (Coded Input Signal) | 8-6 |
| 8.4 | Data of Signal Transmission | 8-7 |
| 8.5 | Coupling of the Machine Control Panel 3M to The PC | 8-8 |
| 8.6 | Machine Control Panel Connector Board with Option for Connection of Additional Operating Function | 8-8 |
| 8.7 | Interface Adapter-Connector and Adapter, Position Control Diagnostic Connector | 8-9 |
| 8.7.1 | Interface Adapter-Connector | 8-9 |
| 8.7.2 | Interface Adapter | 8-9 |
| 8.7.3 | Position Control Diagnostic Connector | 8-9 |
| 9 | Board Overview and Strappings | 9-1 |
| 9.1 | Generalities | 9-2 |
| 9.2 | CPU Board 03100 | 9-3 |
| 9.2.1 | Fixed Strappings | 9-3 |
| 9.2.2 | Variable Strappings | 9-3 |
| 9.2.3 | Test Socket P1 | 9-3 |
| 9.2.4 | Switches on the CPU | 9-3 |

| | | |
|--------|--|-------|
| 9.3 | EPROM Memory 03201 | 9-4 |
| 9.4 | RAM Memory 03210 | 9-5 |
| 9.5 | Test Board 03220 | 9-5 |
| 9.6 | Test Board 03221 | 9-5 |
| 9.7 | RAM Memory 03260 | 9-6 |
| 9.8 | Position Control Loop (Actual Value) 03310/03311 | 9-6 |
| 9.9 | Position Control Loop 03315 | 9-8 |
| 9.9.1 | Fixed Strappings | 9-8 |
| 9.9.2 | Fixed Strappings for EXE | 9-8 |
| 9.9.3 | Variable Setting for Probes | 9-9 |
| 9.10 | Position Control (Command Value) 03320 | 9-9 |
| 9.11 | Position Control (Command Value) 0332/03323 | 9-10 |
| 9.11.1 | Fixed Strappings | 9-10 |
| 9.11.2 | Variable Strappings | 9-10a |
| 9.12 | Position Control 03325 | 9-11 |
| 9.12.1 | Fixed Strappings | 9-11 |
| 9.12.2 | Variable Strappings Command Value Output | 9-12 |
| 9.12.3 | Variable Strappings Servo-Ready-Simulation | 9-12 |
| 9.12.4 | Variable Strappings for Probe | 9-13 |
| 9.12.5 | Settings for Command Value Output | 9-13 |
| 9.13 | Position Control 03340 | 9-13 |
| 9.14 | Position Control 03350 | 9-13a |
| 9.14.1 | Fixed Strappings | 9-13a |
| 9.14.2 | Fixed Strappings for EXE | 9-14 |
| 9.14.3 | Variable Settings for Probes | 9-14 |
| 9.14.4 | Variable Strappings for Servo-Ready-Simult. | 9-14 |
| 9.14.5 | Variable Strappings | 9-14 |
| 9.14.6 | Settings for Command Value Output | 9-15 |
| 9.15 | Intergrated EXE | 9-15 |
| 9.16 | I/O Board 03400 | 9-15 |
| 9.16a | I/O Board 03 | 9-15 |
| 9.17 | Input Board | 9-16 |
| 9.18 | Output Board 03421 | 9-16 |
| 9.19 | I/O Board 03450 | 9-17 |
| 9.20 | Output Board 03461 | 9-18 |
| 9.21 | Power Supply 03500 | 9-19 |
| 9.22 | Power Supply 03510 | 9-19 |
| 9.23 | Operator Panel 03700 | 9-19 |
| 9.24 | Operator Panel 03710 | 9-20 |

| | | |
|--------|--|-------|
| 9.25 | Machine Control Panel 03720 | 9-20 |
| 9.26 | Operator Panel 03770 | 9-20 |
| 9.27 | Operator Panel 03780 | 9-20 |
| 9.28 | Couple Board 03800 A | 9-20 |
| 9.29 | Video Interface 03810 | 9-21 |
| 9.30 | Video Interface 03811 | 9-21 |
| 9.31 | List of Strapping Possibilities (Addressing) of the I/O Boards according to the PC Program | 9-22 |
| 10 | Engineering Panel and Test Board | 10-1 |
| 10.1 | Prerequisites | 10-2 |
| 10.2 | Test Board | 10-3 |
| 10.2.1 | Construction | 10-3 |
| 10.2.2 | Test Board Front Plate | 10-3 |
| 10.2.3 | Designation of Switches and LED | 10-4 |
| 10.3 | States | 10-4 |
| 10.3.1 | Normal NC Operation | 10-4 |
| 10.3.2 | Deactivated Engineering Panel Progr. | 10-4 |
| 10.3.3 | Activated Engineering Panel Progr. | 10-5 |
| 10.3.4 | Engineering Panel Program-Hold-state | 10-5 |
| 10.4 | Functions | 10-5 |
| 10.5 | Sequence | 10-6 |
| 10.5.1 | Engineering Panel Activation | 10-6 |
| 10.5.2 | Display | 10-7 |
| 10.5.3 | Break Points | 10-7 |
| 10.6 | Engineering Panel Instructions | 10-9 |
| 10.6.1 | Display and Change of Memory Content | 10-9 |
| 10.6.2 | Display and Change of Register Contents | 10-10 |
| 10.6.3 | Break Point Setting | 10-11 |
| 10.6.4 | Single-Step Instruction | 10-13 |
| 10.7 | Input List | 10-15 |
| 10.8 | NC Address Lists | 10-17 |
| 10.8.1 | Overview for Versions 0 and 2 | 10-17 |
| 10.8.2 | Overview for Version 3 | 10-18 |
| 10.8.3 | Board 03200 | 10-19 |
| 10.9 | Access to PC with the NC-Engineering Panel | 10-20 |

| | | |
|----------|--|-------|
| 10.9.1 | Converting PC to NC Address | 10-20 |
| 10.9.2 | Reading and Setting of Inputs and Outputs of the I/O Boards | 10-20 |
| 10.9.3 | Direct Access of the I/O Boards through PC-Interface without PC, with the Aid of the Engineering Panel | 10-21 |
| 10.9.4 | Display ISTACK with the Engineering Panel | 10-22 |
| 11 | Notes to the PC | 11-1 |
| 11.1 | Prerequisites, Settings for 130 WA | 11-2 |
| 11.1.1 | Assembly | 11-2 |
| 11.1.1.1 | PC 130WA central processing unit 6ES5 - 921-3WA | 11-2 |
| 11.1.1.2 | PC coupling board 03800 A | 11-3 |
| 11.1.1.3 | PC memory board 6ES5 - 350 | 11-3 |
| 11.1.2 | Settings | 11-3 |
| 11.1.2.1 | CPU 6ES5 - 921 | 11-3 |
| 11.1.2.2 | I/O boards 03400, 03410, 03450, 034560 | 11-4 |
| 11.1.2.3 | S5 I/O boards 402-3, 445-3, 444-3, 432-3 | 11-4 |
| 11.1.2.4 | Coupling Board 03800 A | 11-4 |
| 11.1.2.5 | Memory Board 6ES5 - 350 | 11-5 |
| 11.1.3 | Function Test of the PC | 11-6 |
| 11.1.3.1 | PC-CPU | 11-6 |
| 11.1.3.2 | Coupling Board 03800 A: | 11-6 |
| 11.1.3.3 | User Program | 11-7 |
| 11.2 | Prerequisites, Settings for 130 WB | 11-8 |
| 11.2.1 | Assembly | 11-8 |
| 11.2.1.1 | PC 130W, CPU 6ES5 921-3WB | 11-8 |
| 11.2.1.2 | EPR0M Modules | 11-8 |
| 11.2.1.3 | PC Coupling Board 03800 A | 11-8 |
| 11.2.2 | Settings | 11-8 |
| 11.2.2.1 | CPU 130 WB | 11-8 |
| 11.2.2.2 | EPR0M Module | 11-9 |
| 11.2.2.3 | I/O Boards, 03800 A, as in section 11.1 | 11-9 |
| 11.2.3 | Function test for the PC | 11-9 |
| 11.2.3.1 | PC-CPU | 11-9 |
| 11.2.3.2 | Coupling Board | 11-9 |
| 11.2.3.3 | User Program | 11-10 |
| 11.3 | Function Blocks | 11-11 |
| 11.3.1 | Overview | 11-11 |

| | | |
|----------|--|-------|
| 11.3.2 | Function Blocks Designation | 11-12 |
| 11.3.3 | Function Blocks Description | 11-13 |
| 11.3.4 | Designated Variables for Function Blocks | 11-14 |
| 11.3.5 | Flag List | 11-15 |
| 11.4 | Program Examples | 11-16 |
| 11.4.1 | Factory Program | 11-16 |
| 11.4.2 | Structure of the Factory Program | 11-17 |
| 11.4.3 | Shipping Program Printout | 11-18 |
| 11.4.4 | Example of Program Structure with FB12 | 11-20 |
| 11.4.5 | Example of NC Oriented Function Blocks | 11-21 |
| 11.5 | Test Aids | 11-22 |
| 11.5.1 | Input/Output Signal Image on NC/CRT | 11-22 |
| 11.5.2 | PC Program Correction via NC | 11-23 |
| 11.5.3 | Access to PC via NC Engineering Panel | 11-23 |
| 11.5.4 | Service Unit 333-OBA | 11-24 |
| 11.5.4.1 | Application Area | 11-24 |
| 11.5.4.2 | Construction | 11-24 |
| 11.5.4.3 | I/O Board | 11-25 |
| 11.5.4.4 | Program Structure | 11-26 |
| 11.5.4.5 | Program Example | 11-27 |
| 11.5.5 | Service Unit 333 C | 11-28 |
| 11.5.6 | PG 670/PG675 | 11-28 |
| 11.6 | Troubleshooting in the PC | 11-29 |
| 11.6.1 | Interrupt Stack (I-Stack) | 11-29 |
| 11.6.2 | Block Stack | 11-34 |
| 11.7 | | |
| 11.8 | PC Lists | 11-35 |
| 11.8.1 | Memory Map PC 130 WA | 11-35 |
| 11.8.2 | Address List PC 130 WA | 11-36 |
| 11.8.3 | Memory Map Internal RAM 130WA/130WB | |
| 11.8.4 | System Range for Error Localization for 130 WA and 130 WB | 11-38 |
| 11.8.5 | Memory Map 130 WB | 11-39 |
| 11.8.6 | Address List PC 130 WB | 11-40 |
| 11.8.7 | Instruction Sets | |
| 12 | PC Program Correction through NC Operator Panel | 12-1 |
| 12.1 | Generalities | 12-2 |

| | | |
|--------|--|-------|
| 12.1.1 | Using the PC Program Correction | 12-2 |
| 12.1.2 | Prerequisites and Activation of the Program Correction | 12-2 |
| 12.1.3 | Key functions | 12-3 |
| 12.2 | Operation | 12-4 |
| 12.2.1 | Basic Display | 12-4 |
| 12.2.2 | Up and Down Load of PC Program | 12-5 |
| 12.2.3 | PC Initial Clear | 12-6 |
| 12.2.4 | Editor | 12-7 |
| 12.2.5 | Search | 12-10 |
| 12.2.6 | Activation of Blocks Stored in PROMs | 12-11 |
| 12.2.7 | PC-RAM Compression | 12-13 |
| 12.2.8 | Information Functions | 12-13 |
| 12.3 | Examples of Use | 12-14 |
| 12.3.1 | Display of ISTACK at PC-Stop | 12-14 |
| 12.3.2 | Program Correction for Test Puposos | 12-14 |
| 13 | Alarm Description | 13-1 |
| 13.1 | Generalities | 13-1 |
| 13.2 | Alarm List | 13-2 |
| 13.3 | Alarm Description | 13-4 |
| 14 | Basic Version 0 | 14-1 |
| 14.1 | Prerequisites | 14-2 |
| 14.2 | Setting the Standard Machine Data | 14-2 |
| 14.3 | Adaption to the Machine | 14-2 |
| 14.4 | Adaptions of the Velocity Related Machine Data before the First Travel | 14-2 |
| 14.4.1 | Maximum Axis Velocity | 14-3 |
| 14.4.2 | Software Limit Switch | 14-3 |
| 14.4.3 | Reference Point Values | 14-3 |
| 14.4.4 | Velocity Adaption | 14-3 |
| 14.4.5 | Operating Mode Dependent Velocities | 14-4 |
| 14.4.6 | Maximum Speeds for Gear Range | 14-4 |
| 14.5 | Setting the Control Sense for the Axes | 14-4 |
| 14.6. | Moving the Axes | 14-4 |
| 14.6.1 | Drift Compensation | 14-4 |
| 14.6.2 | Adaption of Travel Distance to Command Distance | 14-5 |

| | | |
|--------|--|-------|
| 14.7 | Functional Adaptions | 14-5 |
| 14.7.1 | Handwheel Activation | 14-5 |
| 14.7.2 | Device Coding for Data Input/Output | 14-5 |
| 14.7.3 | Functional Options | 14-5 |
| 14.7.4 | Automatic Determination of the Position, Loop Gain (Kv Factor) | 14-6 |
| 14.8 | Remarks Concerning Erroneous Inputs and Erasing the Memory Ranges | 14-6 |
| 14.9 | Conclusion | 14-6 |
| 14.10 | List 1: Axis Specific Machine Data | 14-7 |
| 14.11 | List 2: Common Machine Data | 14-8 |
| 14.12 | List 3: Machine Data Bits | 14-9 |
| 14.13 | List 4: Possible Devices for Data Input and Output | 14-10 |

SINUMERIK SYSTEM 3

Serial No.

- SINUMERIK 3T
- 3M
- Basic Version

1.1 Check List

Note the preliminary remarks on page 3-1!

Fill out in pencil or complete a copy and place it in the log book.

Check each finished section with a "yes".

Enter all the required values in the appropriate places.

Explanations concerning the individual sections can be found in the start-up instructions.

OEM Start-up

End User Start-up

| Name | Division | Date from | Name | Division | Date from |
|----------|----------|-----------|----------|----------|-----------|
| Customer | Location | to | End User | Location | to |

1. Have the start-up prerequisites been met ? yes

2. Visual checks : line connection, E-Stop,grounding, position measuring devices,cabling,shielding,operator panel,general state yes

3. Software system designation

4. Voltage Function Tests :

- Input voltage on power supply 03500 : V-
- Input voltage on operator panel 03700/03780 V-
- Input voltage on power supply components : 3x V~

5. Enter machine data,especially: travel range limitation, rapid traverse,feed rate,and spindle speed. yes

6. Position control loops of started axes :
 Axis velocity,tacho adjustment,mult-gain factor,position loop gain,acceleration,position monitors,position control loop monitor,analogue speeds;are all adjustments done and tested ? yes

Drive Adjustment

| Axis | X | Y | Z | 4 |
|-----------------------------------|---|---|---|---|
| Maximum velocity Vmax (mm/Min) | | | | |
| Tacho adjustment Umax at Vmax (V) | | | | |
| Position loop gain (m/min/mm):Kv | | | | |

7. Have all manual functions been tested?
Has the customer executed function tests with test tape ? yes

8. Make a machine data tape with printout.
This tape should be placed near the control yes

Include printout in the filled-out machine data list, and put in the log book yes

Check the option list yes

Enter deviating strappings into the list yes

Has the customer been instructed concerning :
drift compensation,
reference point adjustment ,
backlash compensation,
entering these values into the machine data,
generating a tape, and where this tape should be placed ? yes

Do you have a start-up form, and has it been signed by the customer ? yes

Has a copy of this check list been included in the log book ? yes

Signature OEM Start-up

End User Start-up

1.2 Machine Data (complete, even if machine data tape and printout already exist)

| MACHINE DATA SYSTEM 3T | | | | VERSIONS 0, 2 | | | |
|------------------------|--------|----------------------------|--------------------------------|---------------|--------|-------------------------------------|---|
| Nr.*) | S..... | Explanation | Max. Value | Nr. | S..... | Explanation | Max. Value |
| 100 | | Position tolerance | 32000 μm +) | 350 | | Cut-off velocity | 15000 mm/min +) |
| 110 | | Clamp limit | 32000 μm +) | 351 | | Threshold for contour monitor | 15000 mm/min +) |
| 120 | | Acceleration | 6000 m/s^2 | 352 | | Tolerance for contour | 32000 μm +) mm • Test 850 125 • 1000 |
| 130 | | Max. Velocity | 15000 mm/min +) | 353 | | Dwell time for position monitor | 16000 ms |
| 140 | | Velocity command limit | 2048/8192 VELO 1 | 354 | | Velocity command value limit | 3000/12000 VELO 1 |
| 150 | | KV-factor | 10000 s^{-1} | 355 | | Circle end-point monitor | 32000 μm +) |
| 160 | | Limit switch + | \pm 9999999 μm | 356 | | Threshold for compensation motion | 32000 μm +) |
| 170 | | Limit switch - | \pm 9999999 μm | 357 | | Spindle drift | \pm 500 VELO 2 |
| 180 | | Reference point | \pm 9999999 μm | 358 | | Dynamic smoothing exponent f.thread | 5 |
| 190 | | Backlash compensation | \pm 225 μm +) | 359 | | Maximum speed for 8 gear ranges | 9999 1/min |
| 200 | | Tool reference point value | \pm 9999999 μm +) | 360 | | | |
| 210 | | Reference point shift | \pm 9999 μm +) | 361 | | | |
| 220 | | Multi-gain | 32000 C x min/m | 362 | | | |
| 230 | | Drift compensation | + 500/2000 VELO 1 | 363 | | | |
| 231 | | | | 364 | | | |
| | | | | 365 | | | |
| | | | | 366 | | | |
| | | | | 371 | | Manual feed | 15000 mm/min |
| | | | | 372 | | Man. rapid trav. | |
| | | | | 373 | | Ref. approach vel. | |
| | | | | 374 | | INC speed | |
| | | | | 375 | | DRY feed | |
| | | | | 376 | | Dwell time for spindle inhibit | 16000 ms |
| | | | | 377 | | Min. spindle motor speed | 8192 VELO 2 |
| | | | | 381 | | Software edition | (32000) |
| | | | | 383 | | Increase update time | 30 1/2 ms |
| | | | | 385 | | 2nd. software limit switch X- | \pm 9999999 μm |

+) for the limit values for degrees, resp. inches, see the machine data description (sec. 7)

Machine Data Bits

| Nr. | Bit | | | | | | | |
|--------|-----|---|---|---|---|---|---|---|
| | 7 | 6 | 5 | 4 | 3 | 2 | 1 | 0 |
| N 400S | | | | | | | | |
| N 401S | | | | | | | | |
| N 402S | | | | | 0 | 0 | 0 | 0 |
| N 403S | 0 | 0 | | | | | | |
| N 404S | 0 | 0 | | | | | | |
| N 405S | 0 | 0 | 0 | 0 | 0 | 0 | 0 | 0 |
| N 406S | 0 | 0 | 0 | 0 | 0 | 0 | 0 | 0 |
| N 407S | | 0 | 0 | 0 | 0 | | | |
| N 408S | | | | | | | | |
| N 409S | 1 | 0 | | | | | 0 | |
| N 410S | | | | | | | | |
| N 411S | | | | | | | | |
| N 412S | | | | | | | | |
| N 413S | | | | | | | | |
| N 414S | | 0 | 0 | 0 | 0 | 0 | 0 | 0 |
| N 415S | 1 | | 1 | | 1 | | 1 | |
| N 416S | 0 | | 0 | 0 | 0 | 1 | 1 | 1 |
| N 417S | 0 | 0 | 0 | | | | 0 | |
| N 418S | 0 | 0 | 0 | 0 | 0 | 0 | 0 | 0 |
| N 419S | 0 | 0 | 0 | 0 | 0 | 0 | 0 | 0 |

Do not change the given values

* for axis-specific machine data, the 10°-decade is the axis designation

..... EMPTY PAGE

(complete, even if machine data tape and printout exist)

| MACHINE DATA SYSTEM 3M Versions 0 , 2 | | | | | | | | | | | |
|---------------------------------------|--------|-----------------------------|-------------------------------------|-----------------|--------------------------------|-------------------------------------|----------------------------------|---------------------------------|-----------------------------------|-----------------------------------|---|
| Nr.*) | S..... | Explanation | Max. Value | Nr. | S..... | Explanation | Max. Value | | | | |
| 100 | | Position tolerance | 32000 μm +) | 350 | | Cut-off velocity | 15000 mm/min +) | | | | |
| 101 | | | | 351 | | | | Threshold for contour monitor | 15000 mm/min +) | | |
| 102 | | | | 352 | | | | | | Tolerance for contour | 32000 +) mm • Test 850 125 • 1000 |
| 103 | | | | 353 | | | | | | | |
| 110 | | Clamp limit | 32000 μm +) | 354 | | Velocity command value limit | 3000/12000 VELO 1 | | | | |
| 111 | | | | 355 | | | | Circle end-point monitor | 32000 μm +) | | |
| 112 | | | | 356 | | | | | | Threshold for compensation motion | 32000 μm +) |
| 113 | | | | 357 | | | | | | | |
| 120 | | Acceleration | 6000 0.01 m/s ² +) | 358 | | Dynamic smoothing exponent f.thread | 5 | | | | |
| 121 | | | | 359 | | | | Maximum speed for 8 gear ranges | 9999 1/min | | |
| 122 | | | | 360 | | | | | | Manual feed | 15000 mm/min |
| 123 | | | | 361 | | | | | | | |
| 130 | | Max. velocity | 15000 mm/min +) | 362 | | INC speed | DRY feed | | | | |
| 131 | | | | 363 | | | | Dwell time for spindle inhibit | 16000 ms | | |
| 132 | | | | 364 | | | | | | Min. spindle motor speed | 8192 VELO 2 |
| 133 | | | | 365 | | | | | | | |
| 140 | | Velocity command limitation | 2048/8192 VELO 1 | 366 | | Increase update time | 30 1/2 ms | | | | |
| 141 | | | | 371 | | | | Reference point | \pm 9999999 μm | | |
| 142 | | | | 372 | | | | | | Backlash compensation | \pm 255 μm +) |
| 143 | | | | 373 | | | | | | | |
| 150 | | KV-factor | 10000 0.01 s ⁻¹ | 374 | | Mult-gain | 32000 Cx min/m | | | | |
| 151 | | | | 375 | | | | Drift compensation | \pm 500/2000 VELO 1 | | |
| 152 | | | | 376 | | | | | | Limit switch + | \pm 9999999 μm |
| 153 | | | | 377 | | | | | | | |
| 160 | | 378 | | Reference point | \pm 9999999 μm | | | | | | |
| 161 | | 379 | | | | Backlash compensation | \pm 255 μm +) | | | | |
| 162 | | 380 | | | | | | Reference point shift | \pm 9999 μm +) | | |
| 163 | | 381 | | | | | | | | Mult-gain | 32000 Cx min/m |
| 170 | | Limit switch + | \pm 9999999 μm | 382 | | | | | | | |
| 171 | | | | 383 | | Limit switch - | \pm 9999999 μm | | | | |
| 172 | | | | 384 | | | | Reference point | \pm 9999999 μm | | |
| 173 | | | | 385 | | | | | | Backlash compensation | \pm 255 μm +) |
| 180 | | Reference point | \pm 9999999 μm | 386 | | | | | | | |
| 181 | | | | 387 | | Mult-gain | 32000 Cx min/m | | | | |
| 182 | | | | 388 | | | | Drift compensation | \pm 500/2000 VELO 1 | | |
| 183 | | | | 389 | | | | | | Limit switch + | \pm 9999999 μm |
| 190 | | Backlash compensation | \pm 255 μm +) | 390 | | | | | | | |
| 191 | | | | 391 | | Reference point | \pm 9999999 μm | | | | |
| 192 | | | | 392 | | | | Backlash compensation | \pm 255 μm +) | | |
| 193 | | | | 393 | | | | | | Reference point shift | \pm 9999 μm +) |
| 210 | | Reference point shift | \pm 9999 μm +) | 394 | | | | | | | |
| 211 | | | | 395 | | Drift compensation | \pm 500/2000 VELO 1 | | | | |
| 212 | | | | 396 | | | | Limit switch + | \pm 9999999 μm | | |
| 213 | | | | 397 | | | | | | Limit switch - | \pm 9999999 μm |
| 220 | | Mult-gain | 32000 Cx min/m | 398 | | | | | | | |
| 221 | | | | 399 | | Backlash compensation | \pm 255 μm +) | | | | |
| 222 | | | | 400 | | | | Reference point shift | \pm 9999 μm +) | | |
| 223 | | | | 401 | | | | | | Mult-gain | 32000 Cx min/m |
| 230 | | Drift compensation | \pm 500/2000 VELO 1 | 402 | | | | | | | |
| 231 | | | | 403 | | Limit switch + | \pm 9999999 μm | | | | |
| 232 | | | | 404 | | | | Limit switch - | \pm 9999999 μm | | |
| 233 | | | | 405 | | | | | | Reference point | \pm 9999999 μm |

+) limit values for degrees, resp. inches (see sec.7)

*) the 10° decade is the axis designation for axis-specific machine data ..0 : X-axis ..1 : Y-axis
..2 : Z-axis ..3 : 4th. axis

Machine Data Bits

| Nr. | Bit | | | | | | | |
|--------|-----|---|---|---|---|---|---|---|
| | 7 | 6 | 5 | 4 | 3 | 2 | 1 | 0 |
| N 400S | | | | | | | | |
| N 401S | | | | | 0 | 0 | 0 | 0 |
| N 402S | | | | | | | | |
| N 403S | | 0 | | | | | | |
| N 404S | | 0 | | | | | | |
| N 405S | | 0 | | | | | | |
| N 406S | | 0 | | | | | | |
| N 407S | | 0 | 0 | 0 | 0 | | | |
| N 408S | | | | | | | | |
| N 409S | 1 | 0 | | | | 0 | | 0 |
| N 410S | | | | | | | | |
| N 411S | | | | | | | | |
| N 412S | | | | | | | | |
| N 413S | | | | | | | | |
| N 414S | | 0 | 0 | 0 | 0 | 0 | | |
| N 415S | 1 | | | 0 | 1 | | | |
| N 416S | | 0 | 0 | 0 | 0 | 1 | 1 | 1 |
| N 417S | 0 | 0 | 0 | 0 | 0 | 0 | 0 | |
| N 418S | 0 | 0 | 0 | 0 | 0 | 0 | 0 | 0 |
| N 419S | 0 | 0 | 0 | 0 | 0 | 0 | 0 | 0 |

Do not change the given values.

(complete, even if machine data tape and printout exist already)

| MACHINE DATA SYSTEM 31 | | | | Version 3 | | | |
|------------------------|--------|--------------------------------------|-------------------------|-----------|--------|--|---------------------------------|
| Nr. (*) | S..... | Explanation | Max. Value | Nr. | S..... | Explanation | Max. Value |
| 100 | | Position tolerance | 32000 | 359 | | Maximum speed for 8 gear ranges | 9999 1/min |
| 101 | | | μm +) | 360 | | | |
| 110 | | Clamp limit | 32000 | 361 | | | |
| 111 | | | μm +) | 362 | | | |
| 120 | | Acceleration | 6000 | 363 | | | |
| 121 | | | 0.01 m/s ² | 364 | | | |
| 130 | | Max. velocity | 15000 | 365 | | | |
| 131 | | | mm/min +) | 366 | | | |
| 140 | | Velocity command limit | 2048/8192 | 371 | | Manual feed | 15000 mm/min +) |
| 141 | | | VELO 1 | 372 | | Man. rapid traverse | |
| 150 | | KV-factor | 10000 | 373 | | Ref. approach vel. | |
| 151 | | | 0.01 s ⁻¹ | 374 | | INC speed | |
| 160 | | Limit switch + | \pm 99999999 | 375 | | DRY feed | |
| 161 | | | μm | 376 | | Dwell time for spindle inhibit | 16000 ms |
| 170 | | Limit switch - | \pm 99999999 | 377 | | Min. spindle motor speed | 8192 VELO 2 |
| 171 | | | μm | 378 | | Cut-off spindle speed for M19 | 1/min |
| 180 | | Reference point | \pm 99999999 | 379 | | Gain-factor for M19 | 1/min/360 degrees |
| 181 | | | μm | 380 | | Position limit for M19 | 1/11 degree |
| 190 | | Backlash compensation | \pm 255 | 381 | | Software edition | (32000) |
| 191 | | | μm +) | 383 | | Increase update time | 30 1/2 ms |
| 200 | | Tool reference point value | \pm 99999999 | 385 | | 2nd. software edition switch X- | \pm 99999999 μm |
| 201 | | | μm +) | 386 | | Acceleration time constant for 8 gear ranges | 32000 4 ms |
| 210 | | Reference point shift | \pm 9999 | 387 | | | |
| 211 | | | μm +) | 388 | | | |
| 220 | | Multi-gain | 32000 | 389 | | | |
| 221 | | | Cx min/m | 390 | | | |
| 230 | | Drift compensation | \pm 500/2000 | 391 | | | |
| 231 | | | VELO 1 +) | 392 | | | |
| 350 | | Cut-off velocity | 15000 | 393 | | | |
| | | | mm/min +) | | | | |
| 351 | | Threshold for contour monitor | 15000 +) | | | | |
| 352 | | Tolerance for contour | 32000 | | | | |
| | | | mm-Test 850 125-1000 | | | | |
| 353 | | Dwell time for position monitor | 16000 | | | | |
| | | | ms | | | | |
| 354 | | Velocity command value limit | 3000/12000 | | | | |
| | | | VELO 1 | | | | |
| 355 | | Circle end-point monitor | 32000 +) | | | | |
| | | | μm | | | | |
| 356 | | Threshold for compensation movement | 32000 +) | | | | |
| | | | μm | | | | |
| 357 | | Spindle drift | \pm 500 | | | | |
| | | | VELO 2 | | | | |
| 358 | | Dynamic smoothing exponent f. thread | 5 | | | | |

+) limit values for degrees, resp. inches, (see sec.7)

*) the 10° decade is the axis designation for axis-specific machine data :
 ..0 : X-axis
 ..1 : Z-axis
 (for Nr. 100 through Nr. 231)

Machine Data Bits

| Nr. | Bit | | | | | | | |
|--------|-----|---|---|---|---|---|---|---|
| | 7 | 6 | 5 | 4 | 3 | 2 | 1 | 0 |
| N 400S | | | | | | | | |
| N 401S | | | | | | | | |
| N 402S | | | | | 0 | 0 | 0 | 0 |
| N 403S | 0 | | | | | | | |
| N 404S | 0 | | | | | | | |
| N 405S | 0 | 0 | 0 | 0 | 0 | 0 | 0 | 0 |
| N 406S | 0 | 0 | 0 | 0 | 0 | 0 | 0 | 0 |
| N 407S | | | | | | | | |
| N 408S | | | | | | | | |
| N 409S | 1 | 0 | | | 1 | | 0 | |
| N 410S | | | | | | | | |
| N 411S | | | | | | | | |
| N 412S | | | | | | | | |
| N 413S | | | | | | | | |
| N 414S | | 0 | 0 | 0 | 0 | 0 | 0 | 0 |
| N 415S | 1 | | 1 | | 1 | | 1 | |
| N 416S | | | 0 | | | 1 | 1 | 1 |
| N 417S | 0 | 0 | 0 | | | | 0 | |
| N 418S | 0 | 0 | 0 | 0 | 0 | 0 | 0 | 0 |
| N 419S | 0 | 0 | 0 | 0 | 0 | 0 | 0 | 0 |

Do not change the given values

(complete, even if machine data tape and printout exist)

| MACHINE DATA SYSTEM 3M Version 3 | | | | | | | | | |
|----------------------------------|--------|-----------------------------|-----------------------|-----|--------|--------------------------------|--|----------------------|-------------------|
| Nr.*) | S..... | Explanation | Max. Value | Nr. | S..... | Explanation | Max. Value | | |
| 100 | | Position tolerance | 32000 | 350 | | Cut-off velocity | 15000 | | |
| 101 | | | μm +) | | | | mm/min +) | | |
| 102 | | | | | 351 | | Threshold for contour monitor | mm/min +) | |
| 103 | | | | | | | | 15000 | |
| 110 | | Clamp limit | 32000 | 352 | | Tolerance for contour monitor | 32000 | | |
| 111 | | | μm +) | | | | mm-Test 850 | | |
| 112 | | | | | | $\frac{125 \cdot 1000}{}$ | | | |
| 113 | | | | | 353 | | Dwell time for position monitor | 16000 | |
| 120 | | Acceleration | 6000 | | | | ms | | |
| 121 | | | 0.01 m/s ² | | 354 | | Velocity command value limit | 3000/12000 | |
| 122 | | | +) | | | | | VELO 1 | |
| 123 | | | | | 355 | | Circle end-point monitor | 32000 | |
| 130 | | Max. velocity | 15000 | | | | | μm +) | |
| 131 | | | mm/min | | 356 | | Threshold for compensation motion | 32000 | |
| 132 | | | +) | | | | | μm +) | |
| 133 | | | | | 357 | | Spindle drift | ± 500 | |
| 140 | | Velocity command limitation | 2048/8192 | | | | | VELO | |
| 141 | | | VELO 1 | | 358 | | Dynamic smoothing exponent for thread | 5 | |
| 142 | | | | | | | | | |
| 143 | | | | | 359 | | Maximum speed for 8 gear ranges | 9999 | |
| 150 | | KV-factor | 10000 | 360 | | | | 1/min | |
| 151 | | | 0.01 | | 361 | | | | |
| 152 | | | s ⁻¹ | | 362 | | | | |
| 153 | | | | | 363 | | | | |
| 160 | | Limit switch + | ± 99999999 | 364 | | | | | |
| 161 | | | μm | | 365 | | | | |
| 162 | | | | | 366 | | | | |
| 163 | | | | | 371 | | Manual feed | 15000 | |
| 170 | | Limit switch - | ± 99999999 | 372 | | Man.rapid traverse | | mm/min +) | |
| 171 | | | μm | | 373 | | | | Ref.approach vel. |
| 172 | | | | | 374 | | | | INC speed |
| 173 | | | | | 375 | | | | DRY feed |
| 180 | | Reference point | ± 99999999 | 376 | | Dwell time for spindle inhibit | 16000 | | |
| 181 | | | μm | | | | ms | | |
| 182 | | | | | 377 | | Min.speed spindle motor | 8192 | |
| 183 | | | | | | | VELO 2 | | |
| 190 | | Backlash compensation | ± 255 | 378 | | Cut-off spindle speed for M19 | 1/min | | |
| 191 | | | μm | | | | | | |
| 192 | | | +) | | 379 | | Gain-factor for M19 | 1/min/360 | |
| 193 | | | | | | | | degrees | |
| 210 | | Reference point shift | ± 9999 | 380 | | Position limit for M19 | 1/11 degree | | |
| 211 | | | μm | | | | | | |
| 212 | | | +) | | 381 | | Software edition | (32000) | |
| 213 | | | | | 383 | | | Increase update time | 30 |
| 220 | | Mult-gain | 32000 | | | | 1/2 ms | | |
| 221 | | | Cx min/m | | 386 | | Acceleration time constant for 8 gear ranges | 32000 | |
| 222 | | | | | 387 | | | 4 ms | |
| 223 | | | | | 388 | | | | |
| 230 | | Drift compensation | $\pm 500/2000$ | 389 | | | | | |
| 231 | | | VELO 1 | | 390 | | | | |
| 232 | | | | | 391 | | | | |
| 233 | | | | | 392 | | | | |
| | | | | 393 | | | | | |

+) limit values for degrees, resp. inches (see sec.7)

*) the 10° decade is the axis designation for axis-specific machine data ..0 : X-axis ..1 : Y-axis
..2 : Z-axis ..3 : 4th. axis

Machine Data Bits

| Nr. | Bit | | | | | | | |
|--------|-----|---|---|---|---|---|---|---|
| | 7 | 6 | 5 | 4 | 3 | 2 | 1 | 0 |
| N 400S | | | | | | | | |
| N 401S | | | | | 0 | 0 | 0 | 0 |
| N 402S | | | | | | | | |
| N 403S | | | | | | | | |
| N 404S | | | | | | | | |
| N 405S | | | | | | | | |
| N 406S | | | | | | | | |
| N 407S | | | | | | | | |
| N 408S | | | | | | | | |
| N 409S | 1 | 0 | | | 1 | 0 | | 0 |
| N 410S | | | | | | | | |
| N 411S | | | | | | | | |
| N 412S | | | | | | | | |
| N 413S | | | | | | | | |
| N 414S | | 0 | 0 | 0 | 0 | 0 | | |
| N 415S | 1 | | | 0 | 1 | | | |
| N 416S | | 0 | | | | 1 | 1 | 1 |
| N 417S | 0 | 0 | 0 | | | 0 | 0 | |
| N 418S | 0 | 0 | 0 | 0 | 0 | 0 | 0 | 0 |
| N 419S | 0 | 0 | 0 | 0 | 0 | 0 | 0 | 0 |

Do not change the given values.

1.3 Options available according to shipping notice

| Present | | Order code | Options | 3T/M0 | | 3T/M2 | | 3T/M3 | | |
|---------|----|------------|---------------------------------|-------|---|-------|---|-------|---|-----------|
| Yes | No | | | T | M | T | M | T | M | |
| | | A04 | 4th. axis | - | X | - | X | - | X | 406:7 |
| | | B02 | Paper tape reader w/o reels | X | X | X | X | X | X | |
| | | B03 | Paper tape reader with reels | X | X | X | X | X | X | |
| | | B05 | NC w/o operator panel | X | X | X | X | X | X | |
| | | B06 | Operator panel switch-over | X | X | X | X | X | X | |
| | | B41 | Inch-metric | X | X | X | X | X | X | 408:5,6,7 |
| | | B61 | 3-D interpolation | - | - | - | - | - | X | 416:5 |
| | | B70 | Drilling/Milling patterns | - | - | - | - | - | X | 416:1 |
| | | B72 | Drill pattern, bolt hole circle | - | - | - | - | - | X | 416:1 |
| | | B76 | Read/write system memory, @ 29 | - | - | - | - | X | X | 416:4 |
| | | B78 | In process gauging | - | - | - | - | X | X | 416:3 |
| | | C33 | Chamfers and radii insertion | X | X | X | X | X | X | 415:0 |
| | | C43 | Memory extension to 16 k ch. | X | X | X | X | X | X | |
| | | C44 | Memory extension to 32 k ch. | X | X | X | X | X | X | |
| | | E31 | Threading G33 | S | X | S | X | S | X | 415:1 |
| | | E42 | Oriented spindle stop M19 | - | - | - | - | X | X | 407:4,5,6 |

- = not possible
X = possible
S = standard

Options available according to the shipping list

| Present yes no | Order code | Options | 3T/M0 | | 3T/M2 | | 3T/M3 | |
|---------------------|---------------|---|-------|---|-------|---|-------|---|
| | | | T | M | T | M | T | M |
| 415:5 | F05 | S-analog | S | X | S | X | S | X |
| 415:6 | F71 | External data input | - | - | X | X | X | X |
| 415:2 | J11 | Operator dialogue | X | X | X | X | X | X |
| 415:4 | J12 | Automatic tool offset calculation | X | - | X | - | X | - |
| | J22 | German text display | - | - | - | - | X | X |
| | J23 | French text display | - | - | - | - | X | X |
| | J24 | Italian text display | - | - | - | - | X | X |
| | J25 | Spanish text display | - | - | - | - | X | X |
| | J84 | Machine control panel | X | X | X | X | X | X |
| | K11 | Integrated EXE-times 10X | X | X | X | X | X | X |
| | K12 | Integrated EXE-times 10Y/Z | X | X | X | X | X | X |
| | K51 | Integrated EXE-times 5X | X | X | X | X | X | X |
| | K52 | Integrated EXE-times 5Y/Z | X | X | X | X | X | X |
| | K53 | Integrated EXE-times 5Z | - | X | - | X | - | X |
| | K54 | Integrated EXE-times 5-4th.axis | - | X | - | X | - | X |
| | N20 | PC memory extension 8k EPROM 0.5k RAM for 130 WA | - | - | X | X | X | X |

- = not possible
X = possible
S = standard

Options available according to the shipping list

| Present | | Order code | Options | 3T/M0 | | 3T/M2 | | 3T/M3 | |
|---------|----|------------|--|-------|---|-------|---|-------|---|
| yes | no | | | T | M | T | M | T | M |
| | | N22 | PC memory extension 8k EPROM 4.5k RAM for 130 WA | - | - | X | X | X | X |
| | | N23 | PC memory extension 12k EPROM 4.5k RAM for 130 WA | - | - | X | X | X | X |
| | | N24 | PC memory extension 16k EPROM 4.5k RAM for 130 WA | - | - | X | X | X | X |
| | | N25 | PC memory extension 20k EPROM 4.5k RAM for 130 WA | - | - | X | X | X | X |
| | | N32 | PC memory extension 8k EPROM for 130 WB | - | - | X | X | X | X |
| | | N34 | PC memory extension 16k EPROM for 130 WB | - | - | X | X | X | X |
| | | N60 | Digital input 32 I PC board 420-3 | - | - | X | X | X | X |
| | | N65 | Digital output 32 O PC board 445-3 | - | - | X | X | X | X |
| | | N70 | Digital output 16 O PC board 444-3 | - | - | X | X | X | X |
| | | N81 | Digital Input/Output 48 I,24 O PC board 03400 | - | - | X | X | X | X |
| | | N82 | Digital output 16 O PC board 03460 | - | - | X | X | X | X |

- = not possible

X = possible

Options available according to the shipping list

| Present | | Order code | Options | 3T/M0 | | 3T/M2 | | 3T/M3 | |
|---------|----|------------|---|-------|---|-------|---|-------|---|
| yes | no | | | T | M | T | M | T | M |
| | | N83 | Digital input 96 I PC board 03410 | - | - | X | X | X | X |
| | | N84 | Digital output 48 O PC board 03421 | - | - | X | X | X | X |
| | | N85 | Digital Input/Output 32 I, 32 O PC board 03450 | - | - | X | X | X | X |
| | | N90 | Digital input 16 I PC board 432-3 | - | - | X | X | X | X |

- = not possible

X = possible

1.4 Jumpers on the I/O Boards
(not for version 0)

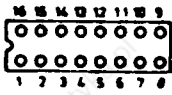
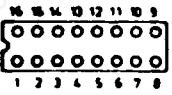
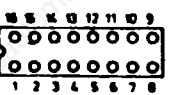
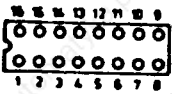
| OPTION | PC board type | Location Nr. | | Address Byte Nr. | Jumper |
|--------|---------------|--------------|-------|------------------|---|
| | | 3T/M2 | 3T/M3 | | |
| | | | | |  |
| | | | | |  |
| | | | | |  |
| | | | | |  |

4. Non-standard Strappings

Complete only in case of deviations

| Designation | Board | Standard Strappings | Special Strappings | |
|---|-------------------------|--|---|-----|
| | | | | Yes |
| 20 mA - Interface | 03100 | NC active | NC passive | |
| Probe output | 03315 03325 03350 | Relay contact or open collector  A B o o open C D o o open E H | Other probe outputs | |
| Velocity control ready | 03320 03325 03350 | external Signal is used o o open P N | Signal is not used  P N | |
| Command value output | 03325 03350 | Command value ground CVG connected to NC-M | other CV circuit | |
| PC outputs are locked in case of NC fault | 03800 A | PC outputs not locked  A B | PC outputs locked  C B | |

2 Lists and Tables

Contents

- 2.1 Standard machine data bits (automatically set bits)
 - 2.2 Machine data list (Overview lists and standard machine data)
 - 2.3 Machine data bits (Overview list)
 - 2.4 TEST display list (following error, actual value, K_V , etc)
 - 2.5 Setting data for versions 0 and 2
 - 2.6 Setting data for version 3
 - 2.7 Alarm list
 - 2.8 Interface signals 3T, 3M
- Code tables for switches, gear ranges, and external signal input (see sec. 8)

2.1 Standard Machine Data Bits

Like the standard machine data (section 2.2), these bits can be set simultaneously (see sec. 4.4 for operation sequence).

SINUMERIK 3T

| Nr. | Machine Data Bits | | | | | | | |
|--------|-------------------|---|---|---|---|----|---|---|
| | 7 | 6 | 5 | 4 | 3 | 2 | 1 | 0 |
| N 400S | 1 | 1 | 1 | 1 | 0 | 1 | 0 | 0 |
| N 401S | 1 | 1 | 1 | 1 | 0 | 0 | 1 | 1 |
| N 402S | 1 | 1 | 1 | 1 | 0 | 0 | 0 | 0 |
| N 403S | 0 | 0 | 0 | 0 | 0 | 0 | 0 | 0 |
| N 404S | 0 | 0 | 0 | 0 | 0 | 0 | 0 | 0 |
| N 405S | 0 | 0 | 0 | 0 | 0 | 0 | 0 | 0 |
| N 406S | 0 | 0 | 0 | 0 | 0 | 0 | 0 | 0 |
| N 407S | 0 | 0 | 0 | 0 | 0 | 1 | 0 | 0 |
| N 408S | 0 | 0 | 0 | 0 | 1 | 0 | 0 | 1 |
| N 409S | 1 | 0 | 1 | 0 | * | 1 | 0 | 0 |
| N 410S | 1 | 1 | 1 | 1 | 1 | 1 | 1 | 1 |
| N 411S | 1 | 1 | 0 | 0 | 0 | 0 | 1 | 0 |
| N 412S | 1 | 1 | 0 | 0 | 0 | 0 | 1 | 0 |
| N 413S | 0 | 0 | 0 | 0 | 0 | 0 | 0 | 0 |
| N 414S | 0 | 0 | 0 | 0 | 0 | 0 | 0 | 0 |
| N 415S | 1 | 0 | 1 | 0 | 1 | 0 | 1 | 0 |
| N 416S | 0 | 0 | 0 | 0 | 0 | ** | 1 | 1 |
| N 417S | 0 | 0 | 0 | 0 | 0 | 0 | 0 | 0 |
| N 418S | 0 | 0 | 0 | 0 | 0 | 0 | 0 | 0 |
| N 419S | 0 | 0 | 0 | 0 | 0 | 0 | 0 | 0 |

For version 0 :

simultaneously 3 and and Line On

For version 2 and 3 :

Simultaneously 5 and and Line On

SINUMERIK 3M

| Nr. | Bits | | | | | | | |
|--------|------|---|---|---|---|----|---|---|
| | 7 | 6 | 5 | 4 | 3 | 2 | 1 | 0 |
| N 400S | 1 | 1 | 1 | 1 | 1 | 0 | 1 | 1 |
| N 401S | 1 | 1 | 1 | 1 | 0 | 0 | 1 | 1 |
| N 402S | 1 | 1 | 1 | 1 | 0 | 1 | 1 | 0 |
| N 403S | 0 | 0 | 0 | 0 | 0 | 0 | 0 | 0 |
| N 404S | 0 | 0 | 0 | 0 | 0 | 0 | 0 | 0 |
| N 405S | 0 | 0 | 0 | 0 | 0 | 0 | 0 | 0 |
| N 406S | 0 | 0 | 0 | 0 | 0 | 0 | 0 | 0 |
| N 407S | 0 | 0 | 0 | 0 | 0 | 0 | 0 | 0 |
| N 408S | 0 | 0 | 0 | 0 | 1 | 0 | 0 | 1 |
| N 409S | 1 | 0 | 0 | 0 | * | 0 | 0 | 0 |
| N 410S | 1 | 1 | 1 | 1 | 1 | 1 | 1 | 1 |
| N 411S | 1 | 1 | 0 | 0 | 0 | 0 | 1 | 0 |
| N 412S | 1 | 1 | 0 | 0 | 0 | 0 | 1 | 0 |
| N 413S | 0 | 0 | 0 | 0 | 0 | 0 | 0 | 0 |
| N 414S | 0 | 0 | 0 | 0 | 0 | 0 | 0 | 0 |
| N 415S | 1 | 0 | 0 | 0 | 1 | 0 | 0 | 0 |
| N 416S | 0 | 0 | 0 | 0 | 0 | ** | 1 | 1 |
| N 417S | 0 | 0 | 0 | 0 | 0 | 0 | 0 | 0 |
| N 418S | 0 | 0 | 0 | 0 | 0 | 0 | 0 | 0 |
| N 419S | 0 | 0 | 0 | 0 | 0 | 0 | 0 | 0 |

Simultaneously 4 and and Line On

Simultaneously 6 and and Line On

- * 0 is set automatically (w/o PC) in version 0
In versions 2 and 3, "1" is set automatically (with PC)
- ** In versions 0 and 2, set to "0"
In version 3, set to "1"

2.2 Machine Data List with Standard Machine Data

AXIS-SPECIFIC MACHINE DATA (TEST)

| Manual input (with automati- cally set standard values) | Explanations | Input unit | Max. input value | Units |
|--|---------------------------|---------------|----------------------------------|-----------------------|
| 10* S 50 | Position tolerance +) | MS | 32 000 | μm |
| 11* S 200 | Clamp limit +) | MS | 32 000 | μm |
| 12* S 50 | Acceleration | IS | 6 000 | 0.01 m/s ² |
| 13* S 10000 | Max. Velocity +) | IS | 15 000 | mm/min |
| 14* S 2048 | Velocity comm. value lim. | - | 2 048/8 192 ²⁾ | VELO 1 |
| 15* S 1666 | Kv-factor | MS | 10 000 | 0.01 s ⁻¹ |
| 16* S ..9999999 | Software limit switch + | MS | $\pm 99\ 999\ 999$ ¹⁾ | μm |
| 17* S .-9999999 | Software limit switch - | MS | $\pm 99\ 999\ 999$ ¹⁾ | μm |
| 18* S 0 | Ref. point value | MS | $\pm 99\ 999\ 999$ ¹⁾ | μm |
| 19* S 0 | Backlash compensation +) | MS | \pm 255 | μm |
| 20* S 0 | Tool ref. point value +) | IS | $+99\ 999\ 999$ ^{1)*} | μm |
| 21* S 0 | Ref. point shift +) | MS | \pm 9 999 | μm |
| 22* S 2400 | Mult-gain | MS | 32 000 | C x mm/min |
| 23* S 0 | Drift compensation | - | \pm 500 | VELO 1 |

+) for limit values and units for degrees or inches, see the machine data description (section 7)

Axis assignment :

| * | 3T | 3M |
|---|--------|-----------|
| 0 | X-axis | X-axis |
| 1 | Z-axis | Y-axis |
| 2 | - | Z-axis |
| 3 | - | 4th. axis |

1) for versions 0 and 2 : max. 9 999 999

2) for 12 BIT DAC : max. 2048

for 14 BIT DAC : max. 8192

MS = units for the measuring system

IS = units for the input system

COMMON MACHINE DATA (TEST)

| Manual input (with automati- cally set stan- dard values) | Explanations | Input unit | Max. input value | Units |
|--|---|---------------|---------------------------|---|
| 350 S.....500 | Cut-off velocity +) | IS | 15 000 | mm/min |
| 351 S.....0 | Threshold for contour monitor +) | IS | 15 000 | mm/min |
| 352 S.....0 | Tolerance for contour monitor | MS | 32 000 | $\frac{\text{mm} \cdot \text{Test } 850}{125 \cdot 1000}$ |
| 353 S.....500 | Dwell time for pos. monitor | - | 16 000 | ms |
| 354 S....2400 | Velocity comm.value limit | - | 3000/ 12000 ³⁾ | VELO 1 |
| 355 S.....10 | Circle end-point monitor +) | IS | 32 000 | μm |
| 356 S.....10 | Threshold for compensation movement for CRC +) | IS | 32 000 | μm |
| 357 S.....0 | Spindle drift | - | \pm 500 | VELO 2 |
| 358 S.....0 | Dynamic smoothing exponent for thread (2^X-1). <i>sample time</i> | - | 5 | - |
| 359 S.....500 | Maximum speed for 8 gear ranges | - | 9 999 | 1/min |
| 360 S....1000 | | - | | |
| 361 S....2000 | | - | | |
| 362 S....4000 | | - | | |
| 363 S....4000 | | - | | |
| 364 S....4000 | | - | | |
| 365 S....4000 | | - | | |
| 366 S....4000 | | - | | |
| 371 S....2000 | Manual feed +) | IS | 15 000 | mm/min |
| 372 S...10000 | Manual rapid traverse +) | IS | 15 000 | mm/min |
| 373 S...10000 | Ref. pt.approach velocity +) | IS | 15 000 | mm/min |
| 374 S.....500 | INCRemental speed +) | IS | 15 000 | mm/min |
| 375 S....2000 | DRY feed +) | IS | 15 000 | mm/min |
| 376 S....1000 | Dwell time for spindle inhibit +) | - | 16 000 | ms |
| 377 S.....0 | Minimum spindle motor speed +) | - | 8 192 | VELO 2 |

$$\text{VELO 1} = \frac{10 \text{ V}}{2048} \text{ for 12 BIT DAC}$$

$$\text{VELO 2} = \frac{10 \text{ V}}{2048} \text{ for vers.0-2, from software 04}$$

$$\text{VELO 1} = \frac{10 \text{ V}}{8192} \text{ for 14 BIT DAC}$$

$$\text{VELO 2} = \frac{10 \text{ V}}{8192} \text{ for vers.0-2, fr. software 06 up}$$

+) Limit values and units for degrees and inches, see machine data description (sec.7)

3) for 12 BIT DAC, max. 3000

for 14 BIT DAC, max. 12000

| Manual input (with automati- cally set standard values) | Explanations | Input units | Max. input value | Units |
|--|--|----------------|----------------------------|-------------------------|
| 378 S.....0 | Cut-off spindle speed for M19 3) | - | 9 999 | min ⁻¹ |
| 379 S.....0 | Multi-gain factor for M19 3) | - | 10 000 | min ⁻¹ /360° |
| 380 S.....0 | Position limit for M19 3) | - | 1 000 | 1/11 degree |
| 381 S.....0 | Software edition | - | (32 000) | - |
| 383 S.....0 | Increase update time 4) | - | 30 | 1/2 ms |
| 385 S.-9999999 | 2nd.software lim. switch X- x),+) | MS | ± 99 999 999 ¹⁾ | µm |
| 386 S.....0 | Acceleration time const.for 1st. gear 3) | - | 32 000 | 4 ms |
| 387 S.....0 | Acceleration time constant for 2nd. gear 3) | - | 32 000 | 4 ms |
| 388 S.....0 | Acceleration time constant for 3rd. gear 3) | - | 32 000 | 4 ms |
| 389 S.....0 | Acceleration time constant for 4th. gear 3) | - | 32 000 | 4 ms |
| 390 S.....0 | Acceleration time constant for 5th. gear 3) | - | 32 000 | 4 ms |
| 391 S.....0 | Acceleration time constant for 6th. gear 3) | - | 32 000 | 4 ms |
| 392 S.....0 | Acceleration time constant for 7th. gear 3) | - | 32 000 | 4 ms |
| 393 S.....0 | Acceleration time constant for 8th. gear | - | 32 000 | 4 ms |

x) only for the 3T

+) for limit values and units for degrees or inches,
see machine data description (sec. 7)

1) max. = 9 999 999 for versions 0 and 2

3) only for version 3, from software edition 02 up

4) for vers. 0 and 2, from software 06 up
vers. 3, from software edition 02 up

2.3 Machine Data Bits (TEST)

Software ed. 09 for 3T/M0&2
05 for 3T/M3

active only after Power on-Reset

| Nr. | | Bit | | | | | | | | | |
|------|--------------|--|---|-------------------------------------|-----------------------------------|--------------------------------------|--|---|---|--|---|
| | | 7 | 6 | 5 | 4 | 3 | 2 | 1 | 0 | | |
| 400S | | Strobe signal duration | | | | ② | Address of (inserted) radius & chamfer & tool tip (3T)-resp.mill (3M)-radius | | | | ① |
| 401S | | Delay time for strobe signal | | | | ② | Ad.for coding the tool position for 3T only | | | | ① |
| 402S | | Duration for M02/M30 signal | | | | ② | Address of 4th.axis,only for 3M | | | | ① |
| 403S | 1. Axis | Omit axis in the start-interlock | 5) Partial actual value multiplied by 10 | 6) Rotary axis | Partial actual value divided by 2 | Partial actual value multiplied by 2 | Sign change for partial actual value | Sign change for velocity command value | Ref. point approach in (-) direction | | |
| 404S | 2. Axis | " " 5) | " " 6) | " " | " " | " " | " " | " " | " " | | |
| 405S | 3. Axis | " " 5) | " " 6) | " " | " " | " " | " " | " " | " " | | |
| 406S | 4. Axis | " " 5) | " " 6) | " " | " " | " " | " " | " " | " " | | |
| 407S | | NC-start w/o ref.point approach | " " 3) | " " 3) | " " 3) | Spindle speed in (0.1 rpm 3) | Spindle encoder installed | Sign change for spindle actual value | Spindle actual value times 2 | | |
| 408S | | sudden stop on the limit switch | input reset state for inch (G70) | 0 | Position control in inch | Spindle control directly by NC | Aux.function output prior to motion | Auxiliary function output during sequence number search (SNG) ① | | | |
| 409S | | NC-PC interface activation | " " 3) | Feed rate referred to cutter center | Hand wheel installed | PC installed | Diameter programming X-axis (3T) | 2nd measuring board | Length compensation adjusted on non-moving axis | | |
| 410S | active at | DATA Start at MDA | Zero offset data | Tool offset data absolute inch | T.O. data additive input | Part program edit | Dry run feed rate | S N S | Superimpose of S,M,T | | |
| 411S | RS232 Input | Device code (input device) | | | | ⑤ | Baud rate (input device) | | ⑥ | | |
| 412S | RS232 Output | Device code (output device) | | | | ⑤ | Baud rate (output device) | | ⑥ | | |
| 413S | @ | EIA code for @ | | | | | | | | | |
| 414S | | DC control Character w/parity RS232 4) | | | | | | Name of axis associated with the 4th. axis ③ | | | |
| 415S | | CRC (3T) | " " 3) | Analogue spindle speed (only 3 T) | " " 3) | Teach-in playback MDA | " " 3) | Thread and feed/rev. (only 3T) | " " 3) | | |
| 416S | | Block end with carriage return and LF | ACTUAL VALUES X-axis display in diameter (3T) | " " 3) | " " 3) | " " 3) | NC Alarm Texts | Cycles and @ | RS232 (V24.2) | | |

*) Single bits according to Start-up instructions or Control Data table.

| Nr. | BIT | | | | | | | | 0 |
|------|-----|---|---|--|--|---|---|--|---------------------|
| | 7 | 6 | 5 | 4 | 3 | 2 | 1 | | |
| 417S | | | | Decelera- tion to ve- locity of text block 4) | Spindle speed override active in threading 4) | Wear input in diameter (3T) 4) | | | 14-BIT DAC 4) |
| 418S | | | | | | | | | |
| 419S | | | | | | | | | |

- 3) Only version 3, from software edition 02 up.
- 4) Versions 0 and 2, from software edition 06 up.
Version 3, starting with software edition 02.
- 5) Versions 0 and 2, from software edition 07.
Version 3, starting with software edition 03.
- 6) Only version 3, from software edition 03 up.

1 Address for radius, chamfer, and tool radius, as well as for tool nose position and 4th. axis.

| Bit | Name |
|---------|------|
| 3 2 1 0 | |
| 0 0 1 1 | A |
| 0 1 0 0 | B |
| 0 1 0 1 | C |
| 0 1 1 0 | U |
| 0 1 1 1 | V |
| 1 0 0 0 | W |
| 1 0 1 1 | P |

3 Name of the axis to which the 4th. axis is subordinated (only for 3M)

| Bit | Name |
|-----|------|
| 1 0 | |
| 0 0 | X |
| 0 1 | Y |
| 1 0 | Z |

2 Times

| Bit | Time [ms] | |
|---------|-----------|-----|
| | 3T | 3M |
| 0 0 0 0 | 16 | 18 |
| 0 0 0 1 | 32 | 36 |
| 0 0 1 0 | 48 | 54 |
| 0 0 1 1 | 64 | 72 |
| 0 1 0 0 | 80 | 90 |
| 0 1 0 1 | 96 | 108 |
| 0 1 1 0 | 112 | 126 |
| 0 1 1 1 | 128 | 144 |
| 1 0 0 0 | 144 | 162 |
| 1 0 0 1 | 160 | 180 |
| 1 0 1 0 | 176 | 198 |
| 1 0 1 1 | 192 | 216 |
| 1 1 0 0 | 208 | 234 |
| 1 1 0 1 | 224 | 252 |
| 1 1 1 0 | 240 | 270 |
| 1 1 1 1 | 256 | 288 |

7 Auxiliary function output during SNS:

| 1 Bit 0 | Output |
|---------|-------------------|
| 0 0 | none |
| 0 1 | after cycle start |
| 1 0 | During SNS |
| 1 1 | - |

5 Device coding

Meaning of bit

| Bit | Number of Stop-Bits |
|-----|---------------------|
| 7 6 | |
| 0 1 | 1 Stop-Bit |
| 1 0 | 1 1/2 Stop-Bit |
| 1 1 | 2 Stop-Bit |

| Bit 5 | Parity Type |
|-------|-------------|
| 0 | odd |
| 1 | even |

| Bit 4 | Parity Bit |
|-------|-------------|
| 0 | w/o parity |
| 1 | with parity |

| Bit 3 | 'Ready for operation' (DSR) evaluation |
|-------|--|
| 0 | no |
| 1 | yes |

6 Baud rate

| Bit | Baud |
|-------|------|
| 2 1 0 | |
| 0 0 0 | 110 |
| 0 0 1 | 150 |
| 0 1 0 | 300 |
| 0 1 1 | 600 |
| 1 0 0 | 1200 |
| 1 0 1 | 2400 |
| 1 1 0 | 4800 |
| 1 1 1 | 9600 |

5 and 6 : Possible Input/Output Device Connections (Selection Table)

| | Machine datum (binary) | | | | | | | | HEX | Device |
|-------------------|------------------------|----|----|----|----|----|----|----|---|--|
| | B7 | B6 | B5 | B4 | B3 | B2 | B1 | B0 | | |
| Universal Devices | 1 | 1 | 0 | 0 | 0 | 1 | 0 | 0 | C4 | FACIT 4040 with P 81 (1200 BAUD) |
| | 1 | 1 | 0 | 0 | 0 | 0 | 1 | 1 | C3 | FACIT 4070 with M 77 interface (600 BAUD) 54 |
| | 1 | 1 | 0 | 0 | 0 | 0 | 1 | 0 | C2 | PT80 Siemens printer Start-up datum with STT104 Interface (300 BAUD) |
| | 1 | 1 | 0 | 0 | 0 | 1 | 0 | 0 | C4 | SANYO M25020 cassette unit with ZE601 interface (1200 BAUD) |
| | 1 | 1 | 0 | 0 | 0 | 1 | 0 | 0 | C4 | SME (1200 BAUD) |
| | 1 | 1 | 0 | 0 | 0 | 1 | 0 | 0 | C4 | Coupling NC — NC wire controlled (1200 BAUD) |
| | 1 | 1 | 0 | 0 | 0 | 1 | 0 | 0 | C4 | FACIT 4030 (1200 BAUD) |
| Special Devices | 0 | 0 | 0 | 0 | 0 | 0 | 0 | 0 | 00 | Output : PT80 (300 BAUD) 4) Input : S-tape reader |
| | 0 | 0 | 0 | 0 | 0 | 1 | 1 | 1 | 07 | Siemens tape reader with and without reel (9600 BAUD) |
| | 0 | 0 | 0 | 0 | 1 | 1 | 1 | 1 | 0F | Siemens tape reader with and without reel (9600 BAUD) |
| | 0 | 0 | 0 | 1 | 1 | 0 | 0 | 0 | 18 | Teletype ASR-33 full duplex 6) (110 BAUD) 10 |
| | 0 | 0 | 1 | 0 | 0 | 1 | 1 | 0 | 26 | FANUC hand reader 4) DC1/DC3 controlled (4800 BAUD) |
| | 0 | 0 | 1 | 1 | 0 | 1 | 1 | 0 | 36 | FANUC system P/D 4) (4800 BAUD) |
| | 0 | 0 | 1 | 0 | 0 | 1 | 0 | 0 | 24 | Coupling NC — NC 4) with control characters DC1-DC4 (1200 BAUD) |
| 0 | 0 | 1 | 0 | 0 | 1 | 1 | 1 | 27 | FACIT 4040 with P 81 4) with control characters DC1-DC4 (9600 BAUD) | |

4) For versions : - 0 and 2 from software edition 06 up
- 3 from software edition 02 up

6) For versions : 0 and 2 (from software 04 and 05 up), and
3 (from software edition 01),
the following machine data must be entered for teletype ASR-33 : 1100 0000.

2.4 Display (Test)

| ID Nr. | Axis | | Display | Units | |
|--------|------|-----|---------------------------------|--------------------------------------|---|
| | 3T | 3M | | Metric | Inches |
| 800 S | X | X | Following error | μm | 10^{-4} In. |
| 801 S | Z | Y | " | | |
| 802 S | - | Z | " | | |
| 803 S | - | 4th | " | | |
| 810 S | X | X | Actual value (position control) | μm | 10^{-4} In. |
| 811 S | Z | Y | " | | |
| 812 S | - | Z | " | | |
| 813 S | - | 4th | " | | |
| 820 S | X | X | Velocity command value | VELO 1 2048/8192 VELO = = 10 V | |
| 821 S | Z | Y | " | | |
| 822 S | - | Z | " | | |
| 823 S | - | 4th | " | | |
| 830 S | X | X | Partial actual value | μm | 10^{-4} In |
| 831 S | Z | Y | " | update t. | update t. |
| 832 S | - | Z | " | Update time : | |
| 833 S | - | 4th | " | 3T | 8 ms |
| | | | | 3M | 9 ms |
| 840 S | X | X | Contour deviation | μm | 10^{-4} In. |
| 841 S | Z | Y | " | | |
| 842 S | - | Z | " | | |
| 843 S | - | 4th | " | | |
| 850 S | X | X | Calculated position loop gain | 0.001 | 0.001 |
| 851 S | Z | Y | " | $\frac{\text{m/min}}{\text{mm}}$ | $\frac{\text{In/min}}{1000 \text{ In}}$ |
| 852 S | - | Z | " | | |
| 853 S | - | 4th | " | | |
| 860 S | - | - | Spindle speed command value | VELO 2 | |
| 861 S | - | - | Spindle position | $\frac{360^\circ}{4096}$ | |

$$\text{VELO 1} = \frac{10 \text{ V}}{2048} \text{ for 12 bit DAC}$$

$$\text{VELO 1} = \frac{10 \text{ V}}{8192} \text{ for 14 bit DAC}$$

$$\text{VELO 2} = \frac{10 \text{ V}}{8192} \text{ for versions : 0, 2 from software 06 up}$$

3, from software edition 02 up

$$\text{VELO 2} = \frac{10 \text{ V}}{2148} \text{ for versions : 0, 2 for software 04,05}$$

3, for software 01

2.5 Setting Data : FOR VERSIONS 0 and 22.5.1 Input and Display : Zero Offset,S-max.,M19 Setting Data and R-parameters

| Input Nr. | Address | Display/Input | | Sign | Nr. of decades | Units Metr. In | |
|-------------------|-----------|---------------------------------|---|------|----------------|----------------|--------------------------------|
| 1-4 ²⁾ | X,Y,Z,4th | Zero offset | X | ± | 7 | µm | 10 ⁻⁴ _{In} |
| 5 | X,Y,Z,4th | Programable zero offset G59 | - | ± | 7 | µm | 10 ⁻⁴ _{In} |
| 6 | X,Y,Z,4th | External zero offset | - | ± | 4 | µm | 10 ⁻⁴ _{In} |
| 20 | S | Spindle speed limitation G92 | X | --- | 4 | 1/min | |
| 25 | N | Setting data bits | X | --- | see below | ----- | |
| 100 - 149 | R | R-parameters | X | ± | 7 | ----- | |

2) Starting with software edition 06 , 4 Z0 for 3T

2.5.2 Setting Data Bits (Operator Data)

also see the operating instructions,section 12.4

Identity Nr.

| Input Bit | 0 | 1 |
|-----------|---|---|
| | Hand wheel ,increments per division | |
| | 1 | 100 |
| 7 | 0 or 1 | 1 |
| 6 | 0 1 | 0 |
| 5 | Tape punch ISO-code | Tape punch EIA-code |
| 4 | | |
| 3 | Program start with % 1) | Program start with LF 1) |
| 2 | Tape block parity OFF | Tape block parity ON |
| 1 | Operator dialogue OFF | Operator dialogue ON |
| 0 | Actual value display in reference to machine zero | Actual value display in reference to part's zero *) |

*) Referred to W,without zero offset,without tool offset

1) Starting with software edition 06

2.6. Setting Data FOR VERSION 3

2.6.1 Display and Input Zero Offset, S-max.

M19 Setting Data Bits and R-parameters

| Input Nr. | Address | Display/Input | Sign | Decade Nr. | Units | | |
|-------------------|-----------|--|------|------------|-------|------------|--------------------------------|
| | | | | | metr. | inch | |
| 1-4 ²⁾ | X,Y,Z,4th | Zero offset | X | ± | 8 | μm | 10 ⁻⁴ _{In} |
| 5 | X,Y,Z,4th | Programable zero offset G59 | --- | ± | 8 | μm | 10 ⁻⁴ _{In} |
| 6 | X,Y,Z,4th | External zero offset | --- | ± | 4 | μm | 10 ⁻⁴ _{In} |
| 20 | S | Spindle speed limitation G92 | X | --- | 4 | 1/min | |
| 22 | S | Oriented spindle stop ¹⁾ M19 | X | + | 4 | 0.5 degree | |
| 25 | N | Setting data bits see 2.6.2 | X | --- | 8 | --- | |
| 26 | N | Setting data bits see 2.6.3 | X | --- | 8 | --- | |
| 100 - 199 | R | R-parameters | X | ± | 8 | --- | |

2) Starting with software edition 02 , 4 Z0 for 3T

2.6.2 Setting Data Bits Nr. 25 (Operator Data)

| Input Bit | 0 | 1 |
|-----------|--|---|
| 7 | | |
| 6 | | |
| 5 | Tape punch ISO-code | Tape punch EIA-code |
| 4 | | |
| 3 | Program start with % ¹⁾ | Program start with LF ¹⁾ |
| 2 | Tape block parity OFF | Tape block parity ON |
| 1 | Operator dialogue OFF | Operator dialogue ON |
| 0 | Actual value display in reference to machine zero | Actual value display in ^{*)} reference to work piece zero |

1) Starting with software edition 02

*) Referred to W, without zero offset, without tool offset

2.6.3 Setting Data Bits Nr. 26 (Operator Data)

| Input Bit | 0 | 1 |
|--------------|---|---|
| 7 | | |
| 6 | | |
| 5 | | |
| 4 | | |
| 3 | | |
| 2 | Hand wheel increments per division 0 | Hand wheel increments per division 100 |
| 1 | Hand wheel increments per division 0 | Hand wheel increments per division 10 |
| 0 | Hand wheel increments per division 0 | Hand wheel increments per division 1 |

2.7 Alarm List

| Clear | Mr.: J. 1. Decade 2. Decade | 8 Bit 7 | 7 Bit 6 | 6 Bit 5 | 5 Bit 4 | 4 Bit 3 | 3 Bit 2 | 2 Bit 1 | 1 Bit 0 | |
|-------|-----------------------------------|----------------------------|--|-------------------|------------------------|---|------------------------|--------------------------|-------------------------|--|
| | 00 | | | | Axis 1 | | | Axis 1 | Axis 1 | |
| | 01 | | | | Axis 2 | | | Axis 2 | Axis 2 | |
| | 02 | | | | Axis 3 | | | Axis 3 | Axis 3 | |
| | 03 | | | | Axis 4 | | | Axis 4 | Axis 4 | |
| | 10 | Axis 1 | | | Axis 1 | Axis 1 | Axis 1 | Axis 1 | Axis 1 | |
| | 11 | Axis 2 | | | Axis 2 | Axis 2 | Axis 2 | Axis 2 | Axis 2 | |
| | 12 | Axis 3 | | | Axis 3 | Axis 3 | Axis 3 | Axis 3 | Axis 3 | |
| | 13 | Axis 4 | | | Axis 4 | Axis 4 | Axis 4 | Axis 4 | Axis 4 | |
| /// | 22 | Spindle encoder fault | | | | Position control loop monitor of spindle *) | Emergency Stop | Control not ready | | |
| | 23 | Time monitor V24 Interface | Overflow 2 Hardware Reader error | No stop-bit | Overflow | Parity | Control word transfer | Overflow 1 | Stop-bit - parity error | |
| | 24 | | | | | | | Over-temperature | | |
| | 25 | | Block w/o LF or with more than 120 charct. | | | Operating error V24 interface | Parity error in memory | Program not in memory | Block not in memory | |
| | 26 | | | | | | | 1) | SNS block not found | |
| | 27 | Memory overflow | Discrepancy between memory and tape progr. | Tape format error | Tape input not allowed | Block with more than 120 charact | Block parity error | Irrelevant EIA character | Character parity error | |
| | 28 | Sub-routine error | Cutter point error | | | | | | General decoding error | |
| | 29 | | False input parameter | False block order | False G02/G03 | False radius value | False angle value | No intersection | False input value | |
| | | | Blueprint Prog. Error | | | | | | | |

*) can be cleared only with PORESET

Alarm List (continued)

| Clear ** | Nr.: 1.. 2nd.Dec. | 1st. Dec. | | 2nd. Dec. | | 3rd. Dec. | | 4th. Dec. | | 5th. Dec. | |
|-------------|-------------------------|--|--------------------------------|-----------------------------------|---------------------------------------|-------------------------------------|------------------------------------|---|-------------------------------------|----------------------------|--|
| | | 8 Bit 7 | 7 Bit 6 | 6 Bit 5 | 5 Bit 4 | 4 Bit 3 | 3 Bit 2 | 2 Bit 1 | 1 Bit 0 | | |
| / | 30 | Circle end-point error | | | | Zero or tool off set value error | | Option not present | Circle not in selected plane | | |
| | 31 | | Too many axes to be driven | No F-word or too large | | Falsely programmed lead | | | | | |
| | 32 | | | | | | | Functions not allowed with selected CRC | | | |
| | 33 | | | | | | | | | | |
| | 34 | | | | | | | | | | |
| | 35 | | | | | | | | | NC-start without ref.point | |
| / | 50 | 2x axis, or more than 2 axes progr. rep. progr. f. | | CRC/ contour error | Blueprint programing error | False block structure | | More than 6 geometry parameters | General | | |
| | 51 | | | Complete block can't be displayed | Preselected block nr. cannot be found | Block with more than 120 characters | Memory overflow | Input inhibited | Reparable programming error | Input only in Reset-state | |
| | 52 | Kv-factor not determined | Kv-factor of axes is not equal | | | | Hold at thread ¹⁾ | | | Strobe-input error | |
| | 53 | General input error | Last progr. not terminated | Only 2 axes allowed at playback | Playback only allowed at axes rest | Playback only when MDI interrupted | Playback in 1st. block not allowed | Program nr. already used | Block with more than 120 characters | MDA Error | |
| Restart | 70 | | | | | | | False address code in machine datum | | | |
| | 71 | | | | | | | | | Battery alarm | |

** Input line (lowest line) must be completely cleared.

Error 70X cannot be cleared with either RESET or CLEAR !

Error 71X can be cleared with CLEAR !

1) Alarm "Hold at Thread"

Versions 0 and 2 up to software 05

Alarm-Nr. 262

Version 3, software 01

2.8 Interface Signals

Input Signals 3T

| NC | | NC -Interface Control or PC | | | | | | | | PC | | | |
|--|---------|---|--|---------------------------------|----------------------|---------------------------------------|----------------------------------|-----------------|------------------|---------------|----------------|-----------|---|
| Test Nr. | Byte | Data bit | | | | | | | | Data Block #9 | | Flag Byte | |
| | | 7 | 6 | 5 | 4 | 3 | 2 | 1 | 0 | DW | Relat. Byte-Ad | | |
| 1. I/O board for 3T, version 0, and interface PC-NC for 3T 2 and 3T 3. | 7 0 | Operating Mode Selector Switch D C B A | | | | Feed/Rapid Override Switch D C B A | | | | 1 H | 0 | 0 | |
| | 7 1 | Key switch | Dry run | Block delete | Single block | Sequence number search (SNS) | Spindle Override Switch C B A | | | 1 L | 1 | 1 | |
| | 7 2 | Rapid traverse override active | Rapid traverse superimpose | Directional Keys X+ X- Z+ Z- | | | | *Deceleration X | Control enable X | 2 H | 2 | 2 | |
| | 7 3 | | 2nd software limit switch-X active | Data start 1) | Gauging 1) | Hand wheel X | NC start | *Deceleration Z | Control enable Z | 2 L | 3 | 3 | |
| | 8 4 | Gear Range Code C B A | | | Spindle direction CW | Spindle enable | Feed enable | | | 3 H | 4 | 4 | |
| 8 5 | *E-stop | Read-in enable | Mirror image Z-values | Mirror image X-values | Axis lock | Without operator panel | | | | 3 L | 5 | 5 | |
| Only 3T 2 3T 3 Interface PC - NC | 8 6 | Strobe signal | External Data Input Code Signal for Strobe E D C B A | | | | | | | | 4 H | 6 | 6 |
| | 8 7 | External Data Input Datum H G F E D C B A | | | | | | | | 4 L | 7 | 8 | |
| | 9 8 | External Data Input Datum Q P O N M L K I | | | | | | | | 5 H | 8 | 7 | |

1) Only 3T 3, from software edition 02 up

| NC | | NC-to-Interface Control or PC | | | | | | | | PC | | |
|---|--------|---|--------------------|------------|------------------------------|---|-------------------------|---------------|------------------|----------------|----------------|-----------|
| Test Nr. | Byte | Data Bit | | | | | | | | Data Block # 9 | | Flag Byte |
| | | 7 | 6 | 5 | 4 | 3 | 2 | 1 | 0 | DW | Relat. Byte-Ad | |
| 1. I/O board for 3T, version 0, and interface NC - PC for 3T 2 and 3T 3 ↑ ↓ | 10 0 | Strobe Signal M S T | | | Spindle in position S1 *) | | Motion Command Z X | | | 7 H 14 | 12 | |
| | 10 1 | Program active | RS232 active 1) | NC Ready 2 | NC Ready 1 | Rapid traverse | Thread | M02/M30 Reset | Program stop MOD | 7 L 15 | 13 | |
| | 10 2 | 10 ¹ BCD Output D C B A | | | | 10 ⁰ BCD Output D C B A | | | | 8 H 16 | 15 | |
| Only 3T 2 and 3T 3. Interface NC - PC ↑ ↓ | 10 3 | | | | | | | | | 8 L 17 | 16 | |
| | 11 4 | | | | | | | | | 9 H 18 | 17 | |
| | 11 5 | 10 ³ BCD Output D C B A | | | | 10 ² BCD Output D C B A | | | | 9 L 19 | 14 | |

Output Signals 3T

1) Only 3T 3, from software 02 up

*) In version 0, the 4-decade S-function is output in two steps :
 S1 ≙ 10³ and 10² decade (high byte), then
 S2 ≙ 10¹ and 10⁰ decade (low byte)

| NC | | NC-to-Interface Control or PC | | | | | | | | PC | | | |
|---|----------|---|--|-------------------------|-------------------------|---|--------------------------------------|----------------------|---------------------|---------------|----------------|-----------|---|
| Test Nr. | Byte | Data Bit | | | | | | | | Data Block #9 | | Flag Byte | |
| | | 7 | 6 | 5 | 4 | 3 | 2 | 1 | 0 | DW | Relat. Byte-Ad | | |
| I/O board for 3M 0, and interface PC - NC for 3M 2 & 3M 3 | 7 0 | Operating Mode Selector Switch D C B A | | | | Feed/Rapid Override Switch D C B A | | | | 1 H | 0 | 0 | |
| | 7 1 | Key switch | Dry run | Block delete | Single block | Sequence number search (SNS) | Spindle Override Switch C B A | | 1 L | 1 | 1 | | |
| | 7 2 | Rapid traverse overrides active | Rapid traverse super-impose | Direction Keys + - | | Axis Selector switch code B A | | *)Deceleration X | Control enable X | 2 H | 2 | 2 | |
| | 7 3 | 4th. axis is main axis | | Data start 1) | Gauging 1) | | NC start | *)Deceleration Y | Control enable Y | 2 L | 3 | 3 | |
| | 8 4 | Gear Range Code C B A | | | Spindle direction CW | Spindle enable | Feed enable | *)Deceleration Z | Control enable Z | 3 H | 4 | 4 | |
| 8 5 | *)E-stop | Read enable | Mirror Image Y | X | Axis lock | Without operator panel | *)Deceleration 4. | Control enable 4. | 3 L | 5 | 5 | | |
| Only 3M 2 & 3M 3 interface PC - NC | 8 6 | Strobe signal | External Data Input Code signal for strobe E D C B A | | | | | | | | 4 H | 6 | 6 |
| | 8 7 | External Data Input Datum H G F E D C B A | | | | | | | | 4 L | 7 | 8 | |
| | 9 8 | External Data Input Datum Q P O N M L K I | | | | | | | | 5 H | 8 | 7 | |

1) only 3M 3, starting with software edition 02

| NC | | NC-to-Interface Control or PC | | | | | | | | PC | | |
|--|--------|---------------------------------|--------------------|------------|------------------------------|----------------------------|--------|---------------|------------------|---------------|----------------|-----------|
| Test Nr. | Byte | Data Bit | | | | | | | | Data Block #9 | | |
| | | 7 | 6 | 5 | 4 | 3 | 2 | 1 | 0 | DW | Relat. Byte-Ad | Flag Byte |
| 1. I/O board for 3M 0, and interface NC - PC for 3M 2 & 3M 3 ↑ ↓ | 10 0 | Strobe Signal M S T S2 *) | | | Spindle in position S1 *) | Motion Command 4. Z Y X | | | 7 H | 14 | 12 | |
| | 10 1 | Program active | RS232 active 1) | NC ready 2 | NC ready 1 | Rapid traverse | Thread | M02/M30 Reset | Program Stop M00 | 7 L | 15 | 13 |
| | 10 2 | BCD Output 10 ¹ | | | | BCD Output 10 ⁰ | | | | 8 H | 16 | 15 |
| Only 3M 2 3M 3 interface NC - PC ↑ ↓ | 10 3 | | | | | | | | | 8 L | 17 | 16 |
| | 11 4 | | | | | | | | | 9 H | 18 | 17 |
| | 11 5 | BCD Output 10 ³ | | | | BCD Output 10 ² | | | | 9 L | 19 | 14 |

Output Signals 3M

1) only 3M 3,
from software 02 up

*) for version 0 (see page 2-16)

3. Prerequisites and Visual Checks

Contents

- 3.1 Preliminary remarks
- 3.2 Start-up prerequisites
- 3.3 Supply voltages
 - 3.3.1 Power supply components
 - 3.3.2 Line condition
 - 3.3.3 Power supply logic components
 - 3.3.4 Line connections for fans
 - 3.3.5 Operator panel power supply
 - 3.3.6 Machine data table
- 3.4 Visual checks
- 3.5 PC boards and assembly
- 3.6 Software system
- 3.7 Information concerning version 1
- 3.8 Information concerning versions 0 and 2 with software edition 04

3.1 Preliminary Remarks

Plastic carpeting as well as the plastic or rubber soles of people's shoes can cause static charge accumulations of up to several kV. Integrated circuits are sensitive to such charges. For this reason, the circuit components and traces should never be touched before having discharged on a grounded part of the machine.

PC boards and power supply lines should never be connected or disconnected while the power is on.

Even when the control is switched off, one must be careful that no short circuits occur in the V_{CC} RAM traces, because these can lead to falsification of information in the buffered CMOS RAM memories, or even cause the traces to burn out.

MOS**WARNING !**Mind the safety
instructions !**MOS****WARNING !**Mind the safety
instructions !

MOS is the technology used to manufacture highly integrated digital circuits. "MOS" is an abbreviation for Metal Oxide Silicon. The main advantages of the MOS method are :

- the simple construction of the transistor
- the high density
- the extremely low power requirements.

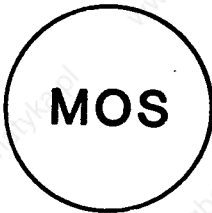
Logo on
packagingM
O
SLogo on the
PC board**WARNING !**

The PC board is assembled with MOS components. Potential equalization is necessary before the PC board is handled, in order to avoid destroying the MOS components. Take the PC board with its conducting foam out of the packaging box, and with your hand, touch a grounded part of the machine. Do not touch components or traces !

(Instruction included in the packaging)

Further Note :

Do not open the special packaging unnecessarily.
Store only in the black (conducting) foam.
Do not bring into contact with plastic materials (because of possible static charge build-up).
Switch off the power supply before insertion or removal.

Prerequisites, which must be met by the customer before Start-up :

The recommended machine data for the particular machine should be on hand.

Electrical and mechanical assembly of the machine must be completed, and the machine must be ready for operation (which should be confirmed by the customer). Also pertinent here is the note in section 3.3.13. Are the drives set up ?

The interface and customer PC program should be functional, tested according to the interface description, and connected to the machine and the NC (this should be confirmed by the customer). Also see the notes in section 3.3.13 .

The position coders must be mounted and wired to the NC (visual check).

The cables to the interface and machine should be connected. The cable shields should be brought to the end point of the control, all according to the interface description.

The flexible grounding cables should be connected (visual inspection) :

- Ground rail at the interface - SINUMERIK 10 mm²
- Ground rail at the interface - Machine base 10 mm²
- SINUMERIK (NC) - Operator panel 6 mm²

Check tapes should be available for testing the machine specific functions.

The customer must make available the personnel needed for assistance to work on the interface, machine operation, and the customer's PC program.

Recommendation : traveling ranges should be limited by moving the hardware limit switches (for larger safety distances).

If the customer has used intermediate connectors in the position control cables, check if the connections are properly made, check for strain relief, and especially for the required shields.

3.3 Supply Voltages

3.3.1 Power Supply Components (if applicable)

Primary 3x 380/415 V / 50 / 60 Hz (tolerances + 10% - 15%)

Secondary + 24 V

Type 6 EV 1350-5AK 20 A

6 EV 1360-5AK 40 A

3.3.2 Line Conditions

The supply voltage for the logic components, including PC and operator panel, is designed for 24 V (DC).

This 24 V supply voltage must be generated from the line voltage by the components of the power supply.

Built-in power supply data :

| | 3T/3M Basic version 0,1 | 3T/3M Basic version 2 | 3T/3M Basic version 3 |
|--|---|---|---|
| Rated line voltage | 24 V ₋ | 24 V ₋ | 24 V ₋ |
| Input voltage range including ripple | 20 to 30 V | 20 to 30 V | 20 to 30 V |
| Input capacity | 8100 μ F | 8100 μ F | 8100 μ F |
| Current consumption 1) Logic components $U_E = 20$ V $U_E = 24$ V $U_E = 30$ V | $I_E = 3.9$ A $I_E = 3.2$ A $I_E = 2.6$ A | $I_E = 5.0$ A $I_E = 4.2$ A $I_E = 3.4$ A | $I_E = 5.4$ A $I_E = 4.5$ A $I_E = 3.6$ A |
| Current consumption 2) Operator panel $U_E = 20$ V $U_E = 24$ V $U_E = 30$ V | $I_E = 1$ A $I_E = 0.8$ A $I_E = 0.7$ A | $I_E = 1$ A $I_E = 0.8$ A $I_E = 0.7$ A | $I_E = 1$ A $I_E = 1.8$ A $I_E = 1.5$ A |

1) Current consumption of the logic components NC + PC without INPUT-OUTPUT of the I/O boards

2) without machine control panel

3.3.3 Power Supply Connection - Logic Components

This connection is made to the terminal strip on the front plate of the 24 V power supply O3 500 (NC) = wire gauge 1.5 mm²
 24 V power supply to the extension rack = wire gauge 1.5 mm²

If multi-conductor cables are used, don't leave free any unused conductor, i.e. redundant conductors must be paralleled.

Wire gauge of the cable for Power On : 2 x 1 mm² shielded

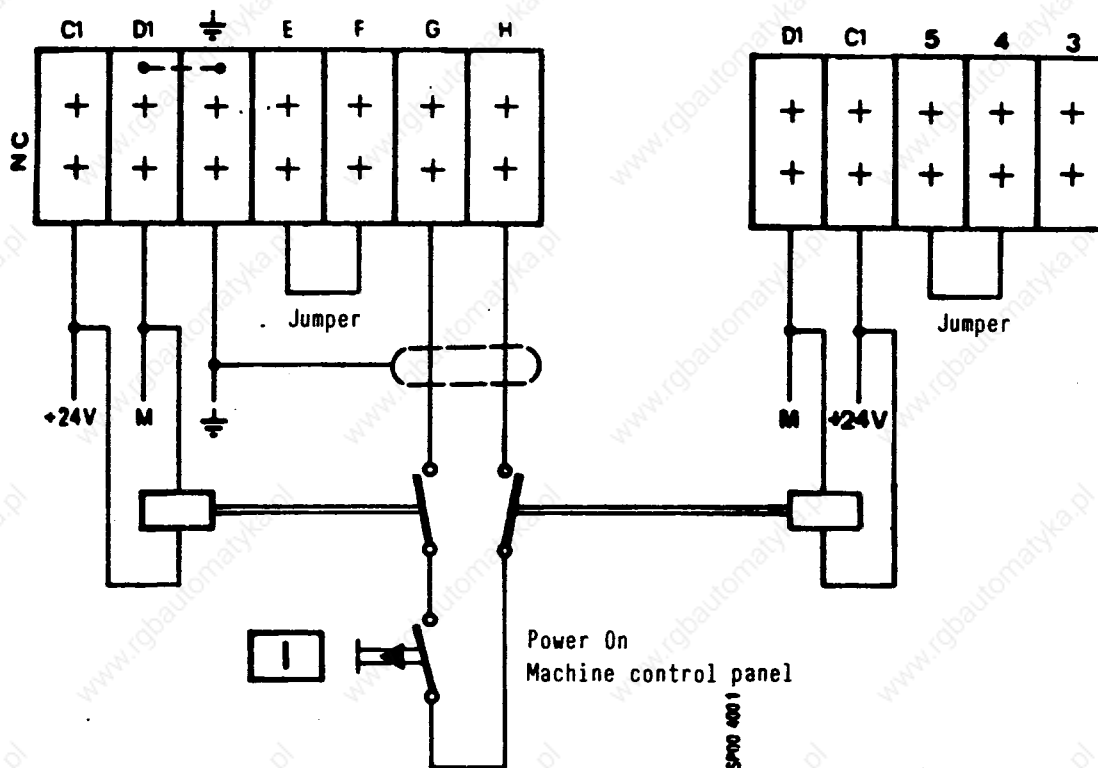

The M-input terminal D1 of the NC connected internally to the chassis (grounded on back plane)

Note :

If external switch components are used for Power On, no latching switches may be used. Connections E - F (remove jumper) can be used as external enable (floating, e.g. relay contact).

3.3.4 Line Connection for Fans

Input voltage : 220 V, 50 Hz

Terminal strip X1



Note :

There may be, in the fan section, a terminal strip X2, but it is not connected. Possible mislabals (e.g. 24 V) must be removed.

3.3.5 Operator Panel Power Supply



Operator Panel Connection Board

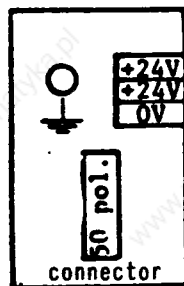

Warning ! Before switching the operator panel on, one must check that the power supply is hooked up with the proper polarity, and that there is a proper M-connection to the logic components. Also see the interface description, section 1.1.7. Improper connection may lead to the destruction of components (IC's) of the operator panel logic, and of logic components. Also check the 6 mm² ground connection to the logic frame.

Operator panel to logic components connection :

| | | Basic version 0,2 | Basic version 3 |
|------------------|-------------------|-------------------|-----------------|
| Operator | PB board type | 03700 | 03780 |
| | 24 V connector | X700 | X785 |
| Panel | 50 pole connector | X702 | X781 |
| | PC board type | 03100 | 03810 |
| Logic Components | 50 pole connector | X102 | X812 |

3.3.6 Machine Control Panel 03 630

Faston connector 6.3 P24
 Input voltage + 24 V_

3.4 Visual Inspection

3.4.1 Grounding

Clean grounding, for the dissemination of external noise, is essential for smooth operation. Special care should be taken that the required wire gauge be used, and that no ground loops are present (also see section 3.2).

3.4.2 Position Coders

Special attention should be paid that the scales (air gaps, etc) and pulse coder (coupling) are properly installed; also see the Heidenhain installation and adjustment instructions. Make sure the connectors are wired correctly and the connections are tight. Different brands of position coders can cause accuracy and surface quality problems, for which we take no responsibility.

3.4.3 Cabling

The power and control cables should be separated. No ground loops are allowed. Poor grounding or ground loops become most apparent as low frequency noise on the velocity command value. This makes smooth runs impossible at low speeds.

Also check for any kinks, proper ducting, and cable tracks.

3.4.4 Shielding

The outer shields of all cables leading to or from the control must be grounded through the connectors at the control (see the interface description). Only the cable to the operator panel has a shield grounded on both ends.

3.4.5 Operator Panel

Check the switches, push-buttons, lamps, symbols, actual value and data displays.

3.4.6 General State

Are the PC boards fastened? Cover plates?

Documents : log book and complete assembly parts list ?

(The assembly parts list is included with the original shipping notice, and must be filed in the log book)

When components are exchanged or in malfunction cases, always check all the socket plugged IC's for proper location and connection.

WARNING !

The 24 V power supply 03500 and RAM memory 03210 should be disconnected only in cases of malfunctions, because machine data etc, are lost otherwise (battery in power supply).

3.4.7 Battery in Power Supply

The back-up battery for the NC and PC is within the power supply unit 03500; it can be exchanged from the front. The positive terminal is at the top, at the insulated contact ; ground shorts must be prevented !

The battery should be changed only while the control is on, so that memory information is not lost. The battery voltage is always checked at PORESET, and if it falls below 2.7 V, alarm 711 lights up.

Battery type : 3.4 V / 5 Ah
 TL 2200
 IEC-R-14 (Baby battery)

Connection for the auxiliary battery :
(only applicable to basic version 2 (with PC))

An external auxiliary battery can be connected to the 6.3 mm faston terminals (marked U-BATT and 0 V) for test purposes. This battery would be located on the backplane of the PC. The terminals can be accessed by removing the right-side (fourth) I/O board (see section 3.4.2) .

WARNING !

For units with integrated PC, if the back-up battery voltage is too low, when the PC is switched on, it goes into Stop-mode. This also prevents the NC from starting, and the red light on the NC-CPU 03100 lights up or flashes (see section 4). In this case no alarm 711 display possible.

3.4.8 Cables

Check all the cables (according to the cable and devices overview in the interface description), and especially those supplied by the customer. At least one connector should be opened and examined closely, with particular attention being paid to conducting elastomere connections. If you find deviations from our guidelines, please inform the sales office concerned, and if necessary, correct the problem (see Interface section 1.1.5).

3.5 NC-Boards and Strappings

3.5.1 Identification System and Generalities

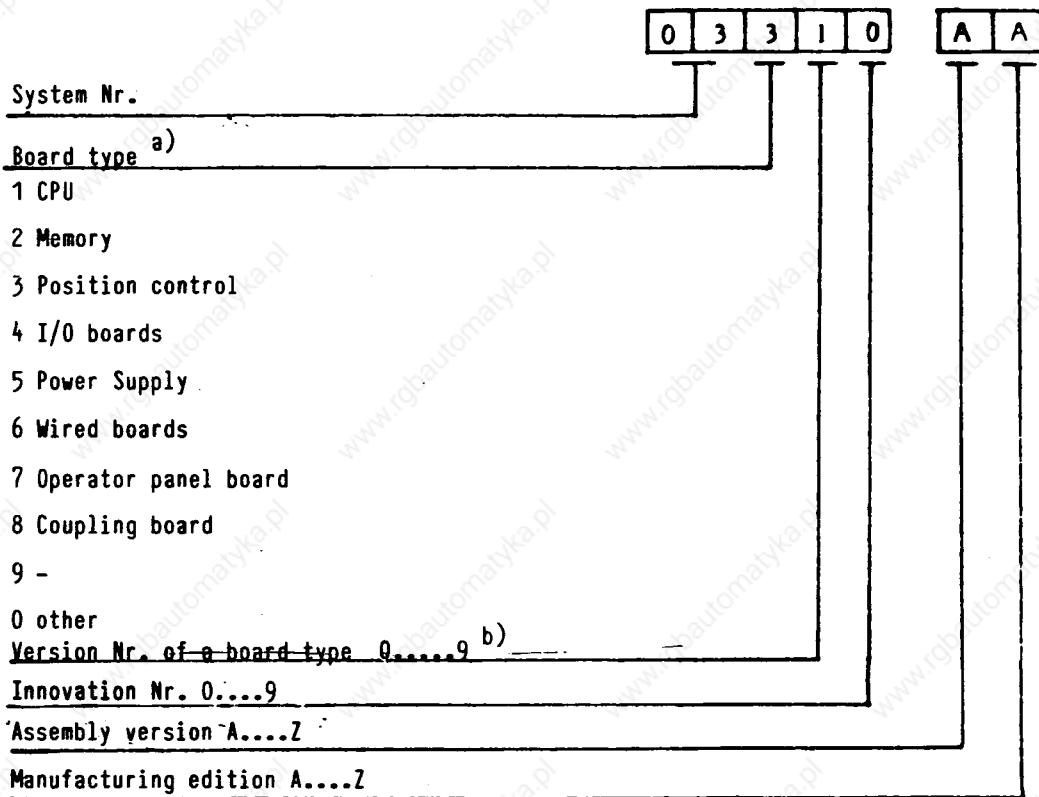

a) For a combination of board types, the more significant board is used for identification.

b) If the number of board variations exceeds 10, the innovation number is also used.

The example shown above is for the position control board in the assembly variety 03 310A. The front plate of this board has here the designation 03 310A/B, but only the left PC board is present; the two connector locations on the top right of the front plate are covered over. This board can be used for 3T or 3M with 3 axes, without S analogue. For the 03 310B assembly variety, both PC boards are present for use with four axes and/or S analogue for the 3M. For connectors arrangement, see section 3.5.2. For board assignment, see section 3.5.2.

On the back edge, the NC boards have only one 96-pole connector for the NC bus. In versions 2 and 3, the couple board 3 800 has, at the top, an additional 48-pole connector for the PC bus. The rest of the boards have two 48-pole connectors.

On the bottom, in the frame at the slot location, an identification strip carries the number of the board to be connected.

Information concerning board handling can be found in section 3.1.

3.5.2 Logic Component Assembly

Assembly of basic version 0



Remark concerning basic version 0 :

Only type 03 400 can be used for Input/Output PC board.

Assembly of basic version 2 :

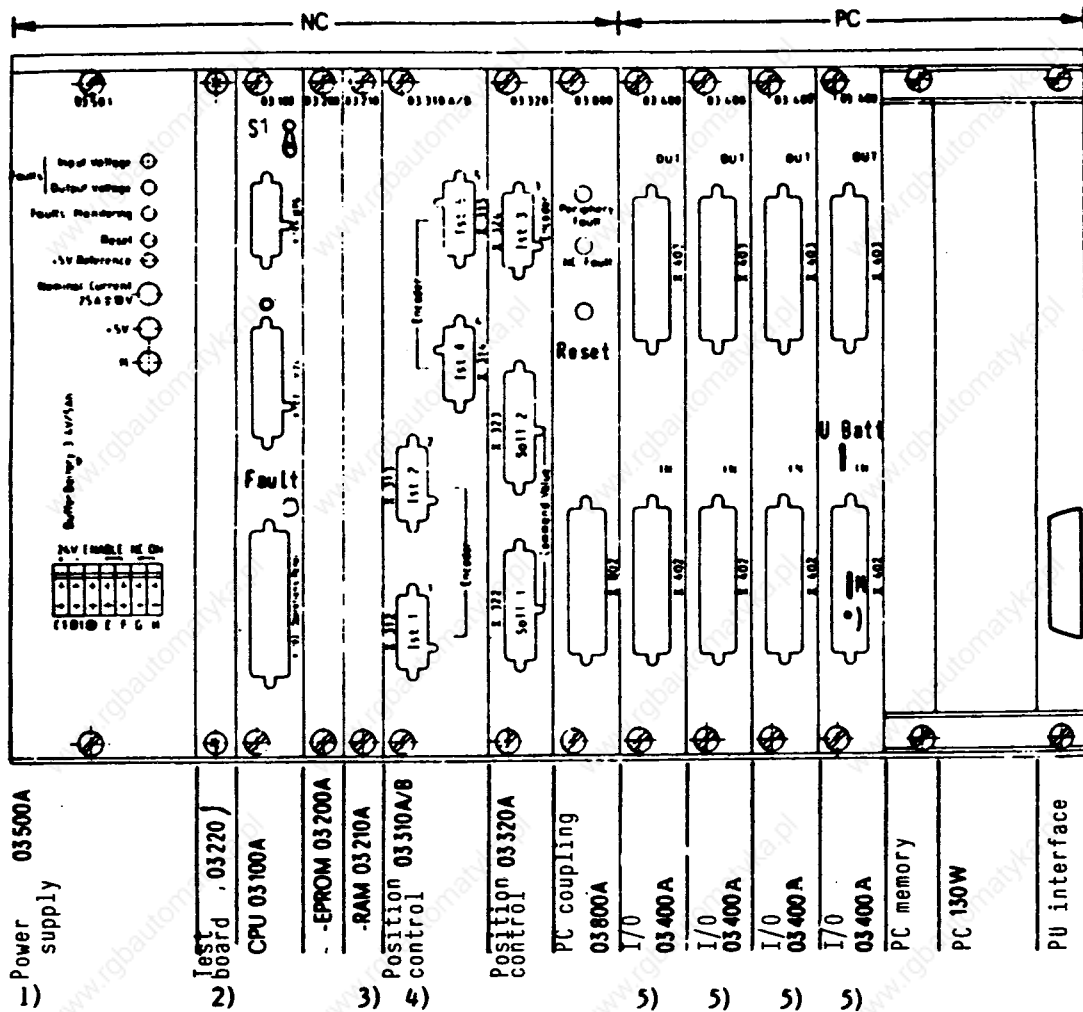

*) Location of the 6.3 mm faston connector for the auxiliary battery (see section 3.3.12)

In exceptional cases (PC malfunction) for version 2, if it becomes necessary to operate without the PC, all PC boards - including the I/O and the coupling boards - must be disconnected. The basic functions of the interface (without the 3rd. and 4th. decades and external data input) can be tested with an I/O board to the 96-pole adaptor +) on the NC bus, (so that there is no connection through the upper 48-pole connectors to the PC bus). In this special case, machine datum 409 bit 3 must be set to 0.

+) see section 9.1

Assembly of version 3



*) Position of the 6.3 mm faston connector for the auxiliary battery

Remarks concerning basic version 3 :

The cable to the operator panel must be connected to PC board 03 810, on the X812 connector.

PC board 03 810 : connector X813 is present only in model 03 811, the connector remains unoccupied.

PC board 03 100 : connector X102 remains free.

In exceptional cases (PC malfunction) for version 3, should it become necessary to operate without the PC, PC board 03 800 must be disconnected, and a 03 400 board can be plugged into the reserved slot. The basic interface functions (without 3rd. and 4th. decades and external data input), can be tested in this manner. In this special case, machine datum 409, bit 3 must be set to zero.

Remarks concerning versions 0 through 3

- 1) Power supply 03501 2 Fault LED's
03502 1 Fault LED (only output voltage fault)
- 2) Engineering panel 03220, normally not assembled.
- 3) PC board 03260 can also be installed for board 03210 :
Program memory 8000 characters = 03260 E
" 16000 characters = 03260 F
" 32000 characters = 03260 G

On the front plate there are two jacks for the connection of 5 V.

The data can be protected before disconnecting the power supply, by connecting a battery.

4) Association of position control boards and connectors

| PC board position control - - connector | 03 310 A | | 03 310 B | | | | 03 320 | | |
|--|---|----------------|--|----------------|----------------|----------------|---------------|---------------|---------------|
| | Act. 1 X312 | Act. 2 X313 | Act. 1 X312 | Act. 2 X313 | Act. 4 X314 | Act. 5 X315 | Com.1 X322 | Com.2 X232 | Act.3 X324 |
| 3T | X | Z | Not used with 3T | | | | X,Z,S | - | S analog |
| 3M X,Y,Z | X | Y | Not used with 3 axes without spindle encoder. | | | | X,Y,Z | 4.,S | Z |
| 3M X,Y,Z and 4th. and/or spindle encoder | Not used from 4 axes up, resp. with spindle encoder. | | X | Y | 4th. | S | X,Y,Z | 4.,S | Z |

For the associations involved with the use of position control boards 03315, 03325, 03350, see the start-up instructions for version 4.

Note: The new position control boards comprise a 14 bit DAC.
Therefore Bit 0 of machine data 417 needs to be set to '1'.

- 5) Input/Output board: For 03400, the 03410, 03420, 03450, 03460 PC boards can also be used, or the S5 boards 420-3, 445-3, 444-3, 432-3.

3.5.3 Strappings

The boards are shipped from the factory with standard strappings. No changes are necessary for a standard start-up. Only for the following applications, the strapping on 03310 and 03320 must be changed (see section 8 through 9.14) :

- 1.) No differential input for position coders (TTL)
- 2.) Velocity control Ready-signal is not brought back from the NC by the drive (alarm 222)

3.5.4 Other SINUMERIK Input and Output Boards

The following input and output boards may currently be used :

| Designation | Input | Output | Word Code |
|-------------|-------|---------------------|-----------|
| 03 410 | 96 | - | N83 |
| 03 402 | - | 48 x 0.5 A | N84 |
| 03 450 | 32 | 32 x 0.1 A floating | N85 |
| 03 360 | - | 16 x 2 A | N82 |

The mounting width of these boards corresponds to 1 2/3 SEP (25 mm) of that of 03 400 (for fuses, see section 4.1.3).

3.5.5 SIMATIC S5 Input and Output Boards

It is possible to install SIMATIC S5 boards (6ES5 4..-3...e.g. N60, N65, N70, N90) into the PC section of versions 2 and 3, instead of the 03 400. The +24 V supply and load must hereby be taken into consideration! The guide rails for input and output boards are equipped for grounding with grounding strips (which should be checked and retrofitted, if necessary). An assembly kit, which can be ordered with order nr. 6FC3 428-4QV, can be provided for mounting the boards and covering the gaps (to ensure proper air conduction).

3.6 Software System

3.6.1 Executive Software

Is the control equipped with a valid software system ?

The software edition is printed on the EPROMs. The latest software edition information can be found in the service circulars.

The actual software edition can be displayed under test 381S.

When exchanging EPROMs, the appropriate tools must be used in order to avoid damaging them. Damaged EPROMs cannot be returned to the factory, which is also true for EPROMs not carrying the GWE label.

For 24...40 pole ICs, central ware house Fürth has available IC-removal tool L 30460-X281-X.

3.6.2 SINUMERIK System 3 - Software Designation System

General guidelines to the designation system of EPROMs/PROMs

Since the introduction of System 3, a new designation system has been used for PROMs; it is based on the 12-digit GWE key. It takes into account the requirements of GWE, of development, process, and service.

The following key is at the basis for the identification of PROM/EPROM designation :

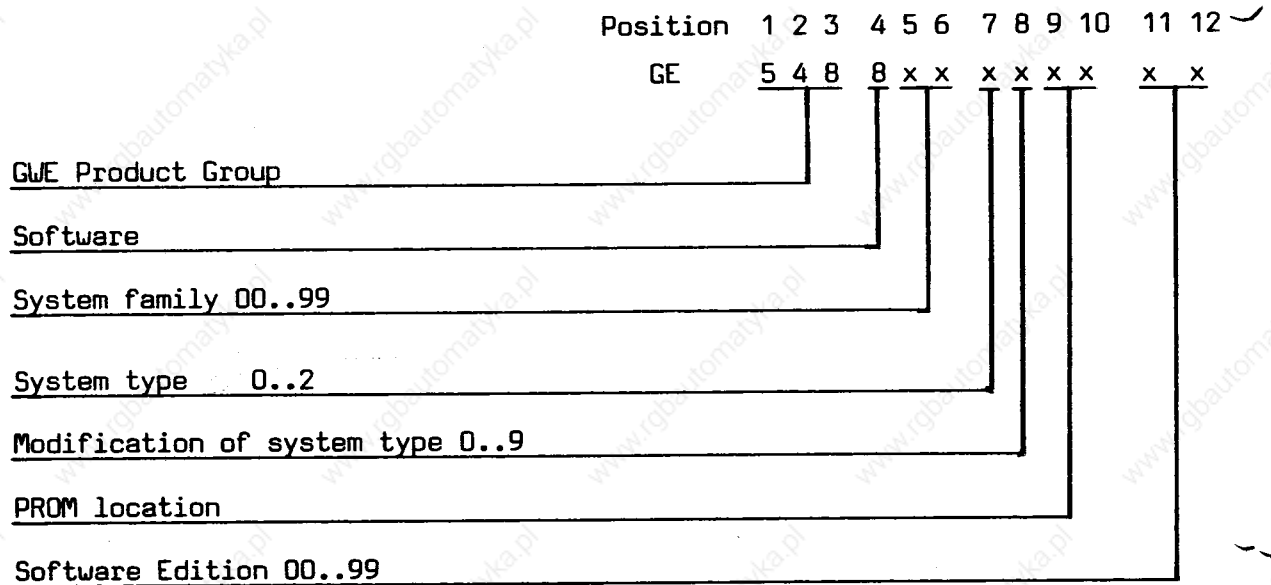

Explanations for the key :

Locations 1 - 4 : These locations always carry the same numbers for identification in GWE data processing

Locations 5 - 6 : For the identification of the system family, versions 0 and 2 have the number 11, and version 3 has the number 15

Location 7 : These positions designate the system type
0 is basic system 3 (common to all types)

Location 8 : These positions designate the modification of the system type :

| | |
|---------------------|--|
| 0 English | * only version 3, from software edition 02 |
| 1 German * | |
| 2 French * | |
| 3 Italian * | |
| 4 Spanish * | |
| 6 Engineering panel | |

Location

9 - 10 : PROM locations are numbered in ascending order of addressing, so that each PROM location has a unique number within the total system.

Location

11 - 12 : The software edition of PROMs changed during revisions, is identical to the last two positions of the number of the revision service circular.
If no general re-translation of the software system is necessary for the revision, the system can contain PROMs with different software editions.

General : For the identification of a PROM/EPROM (outside the GWE), only the last 8 locations must be written.

The PROM location nr. in positions 9+10, and the software edition, in positions 11+12 (the two positions in front -respectively behind- the last decimal point), can be read directly from the PROM plate.

As before, the service circular contains information concerning the extent, edition, and the assembly of the respective system.

Example : Order designation of the system software for 3T and 3M
Versions 0 and 2, software edition 06 :
548 811.00XX.06 XX = PROM location

Version 2, software edition 02, English
548 815.00XX.02

Remarks : The following software editions are valid and can be ordered for versions 0 and 2 :

04
05 delivered as of approximately 4/82
06 delivered as of approx. 5/83
07 delivered as of approx. 12/83
08 delivered as of approx. 4/84

For version 3, the following software editions are valid and available :

01
02 delivered as of approx. 5/83
03 delivered as of approx. 12/83
04 delivered as of approx. 5/84

The controls are not automatically up-dated to the new software editions.

The machine data described in this edition of the service manual correspond to software edition 07, respectively 03.

3.6.3 Operating System Version 0 and 2

Current software edition and check sum of individual PROMs
 EPROM designation GE 548 811 00 XX XX

| FUNCTION | On board | PROM location | PROM type | Edition | | Software Edition and Check | | SUM | | | |
|--|----------|---------------|-----------|---------|--------|----------------------------|-----------|--------|-----------|------|---|
| | | | | ED. 04 | ED. 05 | ED. 06 | Check Sum | ED. 07 | Check Sum | | |
| Versions 0 and 2 3 T & 3 M + Options | 03200 | 01 | 2532 | 04 | 05 | 838A | 06 | 82A1 | 07 | 8304 | |
| | | 02 | 2532 | 04 | 05 | 62AF | 06 | 7322 | - | 712E | |
| | | 03 | 2532 | 04 | 05 | 1E50 | 06 | 288A | - | 2E4A | |
| | | 04 | 2532 | 04 | 05 | 263C | 06 | 35D2 | - | 2E80 | |
| | | 05 | 2532 | 04 | 05 | 4431 | 06 | 5EF8 | - | 7400 | |
| | | 06 | 2532 | 04 | 05 | 5433 | 06 | 7607 | - | 7A92 | |
| | | 07 | 2532 | 04 | 05 | BC75 | 06 | B5CA | - | B9C3 | |
| | | 08 | 2532 | 04 | 05 | ADC8 | 06 | 9821 | - | 7A90 | |
| | | 09 | 2532 | 04 | 05 | 68BE | 06 | 7E6A | - | AD48 | |
| | | 10 | 2532 | 04 | 05 | 7F15 | 06 | 761B | - | 7D32 | |
| | | 11 | 2532 | 04 | 05 | F03E | 06 | DDA5 | - | D6A4 | |
| | | 12 | 2532 | 04 | 05 | C438 | 06 | A596 | - | D358 | |
| | | 13 | 2532 | - | 05 | F941 | 06 | 26C8 | - | FE7E | |
| | | 14 | 2532 | - | 05 | 10CA | 06 | 09F5 | - | E183 | |
| | | 15 | 2532 | - | 05 | 81F7 | 06 | 80F9 | - | 9985 | |
| | | 16 | 2532 | - | 05 | 6894 | 06 | 9204 | - | 78C7 | |
| | | 17 | 2532 | 04 | 05 | 2A34 | 06 | 383E | - | D998 | |
| | | 18 | 2532 | 04 | 05 | 48A7 | 06 | 4052 | 07 | 16CD | |
| | | 19 | 2532 | 04 | - | - | - | - | - | - | - |
| | | 20 | 2532 | 04 | - | - | - | - | - | - | - |
| | | 21 | 2532 | 04 | - | - | - | - | - | - | - |
| | | 22 | 2532 | 04 | - | - | - | - | - | - | - |
| | | 31 | 2532 | 04 | 05 | 7F35 | 06 | 6035 | 07 | 4304 | |
| | | 32 | 2532 | 04 | 05 | 8798 | 06 | 5C95 | 07 | 488C | |
| Total Nr. of PROMs | | | | 20 | 20 | | 20 | | 20 | | |

- PROM not present

3.6.4 Diagnostic System Version 0 and 2

EPROM designation GE 548 811 06 XX XX

| FUNCTION | PC BOARD | PROM location | PROM type | Software Edition | | |
|-------------------|----------|---------------|-----------|------------------|----|----|
| | | | | 01 | 02 | 03 |
| Engineering Panel | 03220 | 71 | 2532 | 01 | 02 | 03 |
| | | 72 | 2532 | 01 | 02 | 03 |
| | | 73 | - | - | - | - |
| | | 74 | - | - | - | - |
| | | 75 | - | - | - | - |
| | | 76 | - | - | - | - |
| | | 77 | - | - | - | - |
| | | 78 | - | - | - | - |
| | | 79 | - | - | - | - |
| | | 80 | - | - | - | - |

All 3 software editions are valid for the engineering panel program.

3.6.5 Operating System Version 3

Current software edition and check sum of individual PROMs

EPROM designation GE 548 815 DX XX XX

| FUNCTION | PC BOARD | PROM Location | PROM Type | Software Edition and Check Sum | | | | | | | |
|-------------------------------------|----------|-----------------------|-----------|--------------------------------|-----------|----|-----------|----|-----------|----|------|
| | | | | 01 | Check Sum | 02 | Check Sum | 03 | Check Sum | | |
| Version 3 3I and 3M + Options | 03200 | 01 | 2532 | 01 | 79CF | 02 | 92BC | 03 | 8FFD | | |
| | | 02 | | 01 | 50FA | 02 | 5B9E | | 7C34 | | |
| | | 03 | | 01 | 4DE8 | 02 | 5301 | | 52E7 | | |
| | | 04 | | 01 | 4320 | 02 | 5732 | | 5D40 | | |
| | | 05 | | 01 | 6610 | 02 | 85F8 | | A5D4 | | |
| | | 06 | | 01 | 82A3 | 02 | 8C81 | | 8CBA | | |
| | | 07 | | 01 | 17E5 | 02 | FD04 | | 2AE6 | | |
| | | 08 | | 01 | 2042 | 02 | E3E1 | | BC30 | | |
| | | 09 | | 01 | 375A | 02 | 6F6F | | 359C | | |
| | | 10 | | 01 | 51DC | 02 | 3526 | | 4466 | | |
| | | 11 | | 01 | COE5 | 02 | 026F | | FF9A | | |
| | | 12 | | 01 | A5DA | 02 | F68D | | F728 | | |
| | | 13 | | 01 | EDCB | 02 | BCD9 | | D30F | | |
| | | 14 | | 01 | 1372 | 02 | B227 | | A37D | | |
| | | 15 | | 01 | DE99 | 02 | 54C1 | | 798A | | |
| | | 16 | | 01 | EB64 | 02 | 77F8 | | 5C67 | | |
| | | 17 | | 01 | BB41 | 02 | ABC0 | | 871A | | |
| | | 18 | | 01 | C1E7 | 02 | C1B3 | 03 | C116 | | |
| | | 19 | | 01 | B819 | - | - | - | - | | |
| | | 20 | | 01 | A8F2 | - | - | - | - | | |
| | | * | | 25 | | - | - | 02 | * | 03 | * |
| | | * | | 26 | | - | - | 02 | * | | * |
| | | * | | 27 | | - | - | 02 | * | | * |
| | | * | | 28 | | - | - | 02 | * | | * |
| | | | | 31 | 2532 | 01 | 4D27 | 02 | 2BB5 | | OE94 |
| | | | | 32 | 2532 | 01 | 5B86 | 02 | 2F60 | 03 | 1B5F |
| | | Total Number of PROMs | | | | 22 | | 24 | | | |

* Language EPROMs, optional

Language EPROMs

| FUNCTION (Language) | Modification and Location | PC BOARD | PROM Type | Software Edition and Check Sum | | | |
|------------------------|---------------------------------|----------|--------------|--------------------------------|--------------|----|--------------|
| | | | | 02 | Check Sum | 03 | Check Sum |
| English | 025 | 03200 | 2532 | 02 | 1326 | 03 | 1959 |
| | 026 | | | 02 | A710 | | 9F3E |
| | 027 | | | 02 | F552 | | 6011 |
| | 028 | | | 02 | FCF2 | | 464B |
| German | 125 | 03200 | 2532 | 02 | 2FD8 | 03 | 32BA |
| | 126 | | | 02 | AB04 | | A84A |
| | 127 | | | 02 | 9625 | | 993B |
| | 128 | | | 02 | 9A1A | | 9639 |
| French | 225 | 03200 | 2532 | 02 | 0F60 | 03 | 0957 |
| | 226 | | | 02 | A53F | | AB44 |
| | 227 | | | 02 | 2062 | | 1477 |
| | 228 | | | 02 | 1A35 | | 1BDD |
| Italian | 325 | 03200 | 2532 | 02 | 1A07 | 03 | 13E0 |
| | 326 | | | 02 | A7C7 | | AE27 |
| | 327 | | | 02 | 1182 | | F4E7 |
| | 328 | | | 02 | FA47 | | 0D0C |
| Spanish | 425 | 03200 | 2532 | 02 | 14E4 | 03 | 1899 |
| | 426 | | | 02 | A172 | | 9F6A |
| | 427 | | | 02 | 8CB8 | | 7219 |
| | 428 | | | 02 | 76B0 | | 8913 |

3.6.6 Diagnostic System , Version 3

EPROM designation GE 548 815 06 XX XX

| FUNCTION | PC BOARD | PROM Location | PROM Type | Software Edition | |
|-------------------|----------|---------------|-----------|------------------|----|
| | | | | 01 | 02 |
| Engineering Panel | 03220 | 71 | 2532 | 01 | 02 |
| | | 72 | 2532 | 01 | 02 |
| | | 73 | - | - | - |
| | | 74 | - | - | - |
| | | 75 | - | - | - |
| | | 76 | - | - | - |
| | | 77 | - | - | - |
| | | 78 | - | - | - |
| | | 79 | - | - | - |
| | | 80 | - | - | - |

Both software editions are valid for the engineering panel program.

3.6.7 PC Diagnostic System for Version 3

EPROM designation GE 548 815 00 XX XX

| FUNCTION | PC BOARD | PROM Location | PROM Type | Software Edition | |
|---------------------------------|----------|---------------|-----------|------------------|--|
| | | | | 01 | |
| Engineering Panel and Diagnosis | 03220 | 71 | 2532 | 01 | |
| | | 72 | . | 01 | |
| | | 73 | . | 01 | |
| | | 74 | . | 01 | |
| | | 75 | . | 01 | |
| | | 76 | . | 01 | |
| | | 77 | . | 01 | |
| | | 78 | . | 01 | |
| | | 79 | . | 01 | |
| | | 80 | 2532 | 01 | |

The PC diagnostic system can be installed independently of the software edition of the operating system.

3.7 Remarks Concerning Version 1

Version 1 has been discontinued.

The following are characteristic of version 1 :

The same software system as for versions 0 and 2,
 The same logic frame width as for version 2 without PC ,
 Only type 03400 can be used for input/output PC boards ,
 Two input/output boards can be installed, unlike in version 0 ;
 when installing the 2nd. I/O board, machine data bit 409 bit 6 must be set.
 This results in 4-decade S-value output, and makes possible the "External
 Data Input" option (as in version 2).

3.8 Remarks Concerning Versions 0 and 2, with Software Edition 04

The following differences exist in comparison with edition 05 :

- Machine data 365, 366, 385 are not present.
- Standard machine data cannot be loaded according to section 4.5 .
- Machine data must be entered for the 4th. axis, even if such axis is not present.
- As of software edition 04, there are option EPROMs in locations 17 - 22. Even functions such as "Cycle", "Cutter Radius Compensation", are not possible without these option EPROMs.
- With software edition 04, RAM board 03210^{-AA} can also be shipped with 4k program memory. This board type cannot be used with other software editions.

- The software edition contains machine data 382 (serial number).

A machine data tape generated prior to the switch to software edition 4 causes, during the reading of datum 382, an alarm and reader stop. In this case, the data up to 381 are read correctly. The remaining data (385 through 419) must be entered manually. It is recommended, that a machine data tape be ultimately punched for the new software edition.

4. Voltage and Function Test, Erasing the Memories, Machine Data Input

Contents

- 4.1 Voltage Test
- 4.2 Function Test
- 4.3 Erasing the Memories (Cancel Operations)
- 4.4 Determining the Control Type (After Clearing the Machine Data)
- 4.5 Loading of Standard Machine Data
- 4.6 Machine and Setting Data Input
- 4.7 Constructing and Handling the Machine Data Tapes, Drift Compensation
- 4.8 Example of Machine Data for a Lathe

4.1 Voltage Test

4.1.1 Voltage Supply

The current for the power supply 03500 has 24 V₋.

Check before connecting the power supply !

Check the rated input voltage on the terminal strip :

| | | Terminal |
|---------------------|---|----------|
| Line voltage | + 24 V ₋ (20 V ₋ ...30 V ₋) | C1, D1 |
| Temperature range | 0 through + 55°C | - |
| Temperature monitor | 63°C ± 2.8°C | - |
| Fan line voltage | 220 V 50 Hz | - |
| Fan monitor | w/o monitor, E/F jumper | E, F |
| NC ON push-button | | G, H |

4.1.2 Power-up Phase

The interface cables should not be connected yet. Axis movement should be inhibited, and the command value connector for the position control loop should be disconnected.

Switch the control on (activate the NC ON push-button for ca. 1 s)

Is the control in operating state ?

Can you see the basic display of the selected operating mode ?

(See section 12 if test board 03220 is being used)

If these points are not satisfied, also check the voltage supply and fuses.

During this test, the power supply must be separated from the equipment.

4.1.3 Fuses

NC :

| Mounting location | Designation | Rated current |
|---------------------------|-------------|------------------|
| Power supply (03500) | F 30 | 16 A fast |
| | F 161 | 0.8 A medium lag |
| I/O board (03400) | F 1 | 1.6 A medium lag |
| Output board (03421) | F 1 | 16 A FF |
| I/O board (03450) | F 1 | 1.6 A medium lag |
| Output board (03460) | F 1 | 1.6 A medium lag |
| Operator panel (03700) | F 1 | 4 A medium lag |
| Operator panel (03780) | F 1 | 2.5 A medium lag |

4.1.4 DC Voltage

A 5 V supply should be measured on the power supply 03500 (jack 5 V against M). Adjust the rated voltage to > 5.15 V...5.25 V with potentiometer R145 on the front plate (clockwise = higher voltage). This ensures the IC supply voltage (voltage drops on the back plane and PC board wiring are taken into account). The 5 V supply is set correctly in the factory, and normally does not have to be adjusted during start-up.

4.1.5 Error Storage while the NC is Switched Off

If power supply 03501 is used : 2 LEDs indicate whether the shut-off was triggered through the input voltage or the internal NC voltages.

The cause for the shut-off is stored, and can be displayed while the control is off, via the "Error Monitoring" key. The shut-off cause remains stored until the next shut-off.

If power supply 03502 is used : only 1 LED is present, and it lights up only after activating the "Error Monitoring" key, if the shut-off was caused by any of the 3 output voltages (5 V, \pm 15 V $_$). It does not light up for input supply errors of defective power supply.

4.2 Function Test

4.2.1 CPU Cycle Monitoring on PC Board 03100 at Power-up :

LED indicates :

Version 2 up to software 06

Version 3 up to software 02

} PC does not start
Battery alarm is displayed
or general errors (see below)

LED flashes with approx. 2 Hz :

Version 2 up to software 07

Version 3 up to software 03

} PC not functioning

LED flashes with approx. 4 Hz

Version 2 up to software 07

Version 3 up to software 03

} Battery alarm is displayed

LED lights up in all versions :

CPU error

EPROM error

Test board activated but not connected

False machine data

Defective NC bus

Incorrectly strapped PC board (address, WAIT)

Position control-,EPROM-,RAM-,PC interface defective

4.2.2 CPU Cycle Monitoring during Operation :

LED lights up :

Hardware fault

DMA to PC not possible

4.2.3 Check Sum Test of the System Program Memory

Operation : 1. Set switch S3 (inside) on the CPU in position 2 (top).

This is the normal position,if no engineering panel mode is conducted with the test board.

2. System Reset (e.g.during power-up: PORESET)

This starts the check sum test procedure.If a defective EPROM chip is discovered,the display is :

```

EPROM - ERROR - FOUND
      EDITION  __ (Software edition)
CHIP  __  ACT/SET-SUM  ____/____
      (Chip number
      location nr.
      decimal)
  
```

If no error is found,the processor jumps immediately into normal system program.

3. Further defective chips are displayed by activating the page key.Eventually,the processor jumps into the normal system program if no other defective chips are found.

All connected system program chips are tested.

This PROM check is executed automatically with each PORESET (power-up).

If any deviations are found in the check sum (PROM missing or in the wrong location),the display indicates the location nr.,the correct check sum,and the actual check sum.

EPROMs with GWE stickers are checked automatically during "burning".

4.2.4 Adjusting the CRT Brightness in Version 3

CRT brightness can be adjusted with potentiometer R18, on board 03780.



ATTENTION !

High voltage of ca. 16 kV in the the CRT component on the high voltage transformer, anode wire, and anode connection on the CRT.

4.2.5 Remarks Concerning the CRT in Version 3

Contrast adjustment: normally handled by the manufacturer; if readjustment is necessary, note the following procedure :

Set optimal brightness (R18). Select actual value display (in large letters). Potentiometer R17 (03780) full counter clockwise turn. Subsequently turn R17 clockwise until optimal brightness, sharpness, and contrast are achieved.

CRT cleaning: the CRT is neither acid nor scratch-proof.

Magnetic interference: if the CRT unit is exposed to magnetic fields, the CRT display can become subject to oscillations. Devices that generate electromagnetic fields should be located no less than 300 mm away from the CRT.

4.2.6 Emergency-stop and Limit-switch Test

With the control off, plug in the interface cables.

The functioning of the E-stop and limit-switch are tested without drive enable (velocity command value disconnected).

The interface test (see section 8) can hereby be used.

4.3 Clearing the Memory Ranges (Cancel)

The following situations require cancel operations :

Exchanging the power supply 03500

Exchanging RAM memories 03210/03260

Exchanging the system software on 03200

If undefined displays appear in the selection display

If certain memory ranges need to be cleared.

Canceling is accomplished by pressing the "Cancel"  and the appropriate number keys simultaneously. In this operation, the control is started again with a hardware reset, e.g. the reset key on 03500, or through new power-up. The keys must be pressed until the basic display reappears. The following ranges can be cancelled :



Remark :

If switch S3 on the CPU is in position 2 (down), and no test board is connected, undefined displays can also appear, but in this case cancel operations cannot be executed because the CPU goes into stop-state.

4.3.1 Cancel 0 (in Conjunction with the PC)

The following sequence must be adhered to :

1. Machine data nr. 409 bits 7 and 3 must be set.
2. PC switch on Stop.
3. Press the Cancel and 0 keys simultaneously, and activate hereby the hardware reset (on the power supply).
4. PC switch from Stop to Operation.
5. PC switch from Operation to Stop.
6. PC switch from Stop to Operation.
7. Hardware reset (on power supply).

4.3.2 Cancel 2 (Machine Data)

Cancel 2 is not necessary before loading the standard machine data according to section 4.5, because all the machine data memory is overwritten with inputs 3 through 6.

4.3.3 Cancel 3 (Part Programs and Subroutines)

When using cancel 3, consideration must be given to the fact, that all standard and option cycles are cleared as well.





4.3.4 Cancel 4 (T0 and Z0)

As of software edition 02, version 3 has with options B76 or B78, a background memory of 100 R parameter values. For the B78 option, this background memory contains the machine data for in-process gauging. These data can also be cleared with "Cancel 4".

4.4 Loading the Standard Machine Data, and simultaneously, Establishing the Control Type

With this function, machine data which are firm-stored in the EPROM range of the control can be loaded in the machine data storage, with an operation during control power-up.





Operation for :

| | | | | | |
|-----------|---|---|---|---|------------------|
| 3T/0 | : |  | | | |
| 3M/0 | : |  | + |  | + |
| 3T/2 3T/3 | : |  | | | Power On Reset |
| 3M/2 3M/3 | : |  | | | (or NC power-up) |

The keys must be activated simultaneously, until the basic display appears. For stored standard machine data, see section 2.1 and 2.2. Changing of specific individual machine data according to section 4.6.

4.5 Establishing the Control Type without Changing the Machine Data (for Test Purposes)

After clearing the RAM memory with "Cancel 2" (for machine data see section 4.2) or after exchanging power supply units or the RAM memory board, the control type can be established without setting the standard machine data. The control type is then stored in RAM.

| | | | | |
|---|---|---|---|---|
|  | + |  | + | Power On Reset = 3 T without standard machine data transfer |
|  | + |  | + | Power On Reset = 3 M |

Keys 1 or 2 and  must be pressed until the basic display appears. The loading of the standard machine data (section 4.4) transmits the control type automatically.

4.6 General Information Concerning the Input of Machine and Setting Data

Page TEST  and MDI-SE-TE 

Independent of operating mode, except DO/DI, with the mode key in the TEST position, there is among other things, a group of pages for the display of machine data.

This group of pages has a preselect cursor that, after mode key activation, will return to the last displayed page of this selection group.

It is possible to change the corresponding cursor by activating :

the page key   ... and cursor key  ...

The cursor generally moves line by line; if it leaves the display, the next page will be shown.

Manual change of values can only be done in the MDI-SE-TE operating mode:

Operating mode :  Page (Mode) 



Complete value blocks cannot be cleared. The values are also protected by a data safety switch S1 on the front plate of the CPU. Only the setting of drift compensation values is independent of the data safety switch. Machine data are never entered with decimal point; some values can carry a sign.

The lowest input value is 0, respectively 1.

The highest allowed input value is determined from the machine data list (see section 2). Do not use any values, not even 0, for unused input numbers; this would inhibit the tape input, and would cause an alarm. With MDI, these unused input numbers are locked.

Example :

Select TEST/Axis-specific Machine Data Values

Select display page TEST and Ident-Nr. via keys  ... or 
The display of machine data is possible in all operating modes, except DATA IN/OUT.

Example for Version 0 and 2:

Selection Display TEST/Axis-specific Machine Data (Nr. 100 - 233)

| | | | | | | | | | | | | | | | | | | | | | | | | | | | | | | | | |
|---|---|---|---|---|---|---|---|--|--|---|---|---|---|---|--|--|--|--|---|---|---|---|---|--|--|--|--|---|---|---|---|---|
| > | 1 | 0 | 0 | S | + | | | | | 3 | 2 | 0 | 0 | 0 | | | | | 1 | 0 | 1 | S | + | | | | | 3 | 2 | 0 | 0 | 0 |
| | 1 | 0 | 2 | S | + | | | | | 3 | 2 | 0 | 0 | 0 | | | | | 1 | 0 | 3 | S | + | | | | | 3 | 2 | 0 | 0 | 0 |
| C | O | M | | A | X | I | S | | | | | | | | | | | | | | | | | | | | | | | | | |

Manual input is only possible in operating mode MDI-SE-TE with data safety switch (S1 in up position on the front plate of CPU 03100).

e.g. : Nr. 100 : S 50  (input) ,or
 Nr. 230 : S 10  (input)

Note to 230 through 233 : for drift compensation, see section 5.5 .

Example for Versions 0 and 2:

Page TEST/General Machine Data Values (Nr. 350 - 385)

| | | | | | | | | | | | | | | | | | | | | | | | | | | | | | | | |
|---|---|---|---|---|---|---|---|--|--|---|---|---|---|---|--|--|--|---|---|---|---|---|---|--|--|--|---|---|---|---|---|
| > | 3 | 5 | 4 | S | + | | | | | 3 | 0 | 0 | 0 | | | | | 3 | 5 | 5 | S | + | | | | | 3 | 2 | 0 | 0 | 0 |
| | 3 | 5 | 6 | S | + | | | | | 3 | 2 | 0 | 0 | 0 | | | | | 3 | 5 | 7 | S | + | | | | | 2 | 0 | 4 | 8 |
| C | O | M | | D | A | T | A | | | | | | | | | | | | | | | | | | | | | | | | |

Example for Versions 0 and 2:

Page TEST/Machine Data Bits (Nr. 400 - 419)

| | | | | | | | | | | | | | | | | | | | | | | | | | | | | | | | |
|---|---|---|---|---|---|---|---|---|---|---|---|---|---|--|--|--|--|---|---|---|---|--|---|---|---|---|---|---|---|---|--|
| > | 4 | 0 | 2 | S | | 0 | 1 | 0 | 0 | 0 | 1 | 1 | 1 | | | | | 4 | 0 | 3 | S | | 0 | 0 | 1 | 0 | 1 | 0 | 1 | 0 | |
| | 4 | 0 | 4 | S | | 1 | 0 | 1 | 0 | 1 | 0 | 1 | 0 | | | | | 4 | 0 | 5 | S | | 0 | 0 | 1 | 0 | 1 | 0 | 1 | 0 | |
| C | O | M | | D | A | T | A | | | | | | | | | | | | | | | | | | | | | | | | |

In the MDI of machine data bits, leading zeroes may be skipped, e.g.
 403 : S 101010 is automatically complemented to 00101010. The "S" address character must be entered in front of the bit pattern, respectively numerical value.

4.7 Constructing and Handling the Machine Data Tape

4.7.1 Constructing the Machine Data Tape

Read a standard machine data tape with already known values of the machine.

Tape construction :

```
%TELF
N100S ...LF
N101S ...LF
  ⋮
M02LF
```

Remarks :

"N" for the Ident-Nr. is mandatory for the machine data tape. "N" does not appear during manual machine data input. In the service manual the Ident-Nr. is sometimes only indicated by "Nr."

4.7.2 Preparing for Reading the Tape

Load the standard machine data according to 4.4, and then set the data safety switch in the "up" position (S1 on the CPU front plate as in the 03100 circuit diagram).

Reset



MDI-SE-TE



Operating mode for MDI of required machine data

TE



Check the required machine data nr. 409, 411, and 416 (see below).

If the machine data are not entered acc. to 4.4, or if the input device does not agree with the machine data entered, inputs -respectively changes- must be made manually.

MDIs are made under Ident-Nr. 411 for the interface device designation and baud rate (see machine data bit list). For the operating mode selection switch to be functional, bit 7 under Ident-Nr. 409 and bit 0 under Ident-Nr. 416 must be set to 1.

If you are dealing with an integrated PC, bits 3 and 7 under Ident-Nr. 409 must be entered simultaneously, and be activated with PORESET (power on-off). After the device name and baud rate have been established in the control, the tape can be read.

4.7.3 Loading the Machine Data Tape

Operating mode selector switch in desired position

Data input



Data Start



The statement "Control in action" appears in the bottom display line, until the tape has been loaded.

Note : If the Test board is active, "Control in action" does not appear in versions 0 and 2, but machine data tape loading is possible.

The values can eventually also be edited manually.

A drift compensation must also be made.

Select : TEST and MDI-SE-TE

> Nr. 230 } S +  (see section 5.5)
 ... 233

After entering the machine data, return the data safety switch to its normal position (switch in "down" position on the CPU front plate). Standard alarms (e.g. position control loop, etc) do not inhibit the loading of the tape.

4.8 Example of Machine Data of a Lathe

Version 3, software edition 02

$$K_v = 1 \frac{\text{m/min}}{\text{min}}, X = 5 \text{ m/min}, Z = 10 \text{ m/min}, \text{for } U_{\text{max}} = \pm 9 \text{ V}$$

% T E

N100 S+20
 N101 S+20
 N102 S+0
 N103 S+0
 N110 S+100
 N111 S+100
 N112 S+0
 N113 S+0
 N120 S+80
 N121 S+80
 N122 S+0
 N123 S+0
 N130 S+5000
 N131 S+10000
 N132 S+0
 N133 S+0
 N140 S+2048
 N141 S+2048
 N142 S+0
 N143 S+0
 N150 S+1666
 N151 S+1666
 N152 S+0
 N153 S+0
 N160 S+452000
 N161 S+1302000
 N162 S+0
 N163 S+0
 N170 S-2000
 N171 S+150000
 N172 S+0
 N173 S+0
 N180 S+450000
 N181 S+1300000
 N182 S+0
 N183 S+0
 N190 S+5
 N191 S+8
 N192 S+0
 N193 S+0
 N200 S+0
 N201 S+0
 N202 S+0
 N203 S+0
 N210 S+0
 N211 S+0
 N212 S+0
 N213 S+0
 N220 S+5400
 N221 S+2700
 N222 S+0
 N223 S+0
 N230 S-3
 N231 S-1

N232 S+0
 N233 S+0
 N350 S+400
 N351 S+0
 N352 S+0
 N353 S+500
 N354 S+2400
 N355 S+10
 N356 S+10
 N357 S+0
 N358 S+1
 N359 S+100
 N360 S+200
 N361 S+400
 N362 S+800
 N363 S+1600
 N364 S+3200
 N365 S+4000
 N366 S+4000
 N371 S+2000
 N372 S+5000
 N373 S+5000
 N374 S+2000
 N375 S+3000
 N376 S+500
 N377 S+10
 N378 S+300
 N379 S+200
 N380 S+11
 N381 S+2
 N383 S+2
 N385 S-99999999
 N386 S+0
 N387 S+0
 N388 S+0
 N389 S+0
 N390 S+0
 N391 S+0
 N392 S+0
 N393 S+0

N400 S 01010100
 N401 S 01010011
 N402 S 01010000
 N403 S 00000000
 N404 S 00000000
 N405 S 00000000
 N406 S 00000000
 N407 S 10000100
 N408 S 00001000
 N409 S 10101100
 N410 S 11101111
 N411 S 11000010
 N412 S 11000010
 N413 S 00000000
 N414 S 00000000
 N415 S 10101010
 N416 S 01000111
 N417 S 00000100
 N418 S 00000000
 N419 S 00000000
 M02

5. Manual Start-up with System Software

Content

- 5.1 Machine Data
- 5.2 Control Polarity of Feed Axes
- 5.3 Closing the Velocity Control Loop
- 5.4 Manual Movement (with Corresponding Alarms)
- 5.5 Drift Compensation
- 5.6 Tests for all Manual Functions
- 5.7 Program Execution

5.1 Machine Data

The standard machine data can be loaded according to section 4.4 , special machine data can be altered manually, or the corresponding machine data tape can be loaded according to section 4.6.3, or all the machine data can be entered manually. List all the machine data used as described in section 1.2, and file them in the log book. If possible, keep a copy of the machine data tape by the control.

5.2 Control Polarity of Feed Axes

Setting the polarity incorrectly causes the axis to move uncontrolled, with maximum velocity.

For this reason, it is very important to check the position control and velocity control polarities before closing the control loop.

Handling :

Keep in mind : The direction of the feed axis (based on customer's statement, or according to ISO standards).

What polarity of the velocity command value causes the axis to move in positive direction ?
(customer's statement, resp. test with battery box)

Check the position control polarity : by moving the feed axis mechanically in positive direction.

Note the direction of the actual value change from the actual value display.

Set the machine data bits for sign change for velocity command value (Nr. 403...406, bit 1) , for sign change for the partial actual value (Nr. 403...406, bit 2).

Example :

Axis motion in positive direction ; hereby, the polarity of the velocity command value :

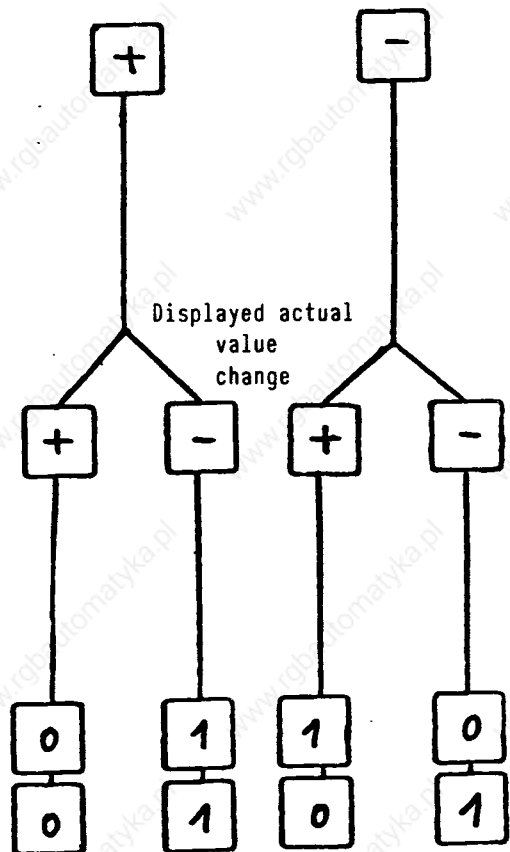

In TEST nr. 403 - nr. 406, bit 1 and bit 2
 (bit 1, sign change for velocity command value)
 (bit 2, sign change for partial actual value),
 the appropriate combination is entered for each axis.

5.3 Closing the Velocity Control Loop

Shut the control off, plug in the command value connector, and remove any interlocks of the particular axis (fuses, control inhibit). All other axes should be still locked. Power the control up.

Warning : Activate the emergency-stop if the feed axis start running away uncontrolled.

Possible causes for a run-away axis :

a) The position control loop or the velocity control loop has wrong polarity :

False machine data bits.

Characteristic : the axis moves with maximum velocity.

b) Position control loop not closed :

Cause : the encoder does not follow the axis movement.

Characteristic : the axis moves with low constant velocity.

Either a ground-short, interruption, or a short circuit trip the position control monitor.

c) The command value does not reach the velocity control :

Characteristic : the axis runs with constant low velocity (drift).

d) Control loop error :

Causes : tacho feedback interrupted

improper polarity for tacho feedback

incorrect optimization

Kv factor too high

Characteristic : the axis oscillates strongly

5.4 Manual Run

Check that all the command value cables of the axes are connected, and the control has the correct polarity. Also, the position control loop should be closed, and the gains should be properly set.

The following alarms can also inhibit the motion of the axes :

| Axis | Alarm |
|------------------|---|
| | 223 E-stop (emergency-stop) |
| | 222 Servo control fault - velocity control not ready |
| 1 2 3 4 | 001 Software limit switches 011 positive direction 021 approach 031 Limits established with machine data 160 ... 163 |
| 1 2 3 4 | 002 Software limit switch 012 negative direction 022 approach 032 limits given by machine data 170 ... 173 |
| 1 2 3 4 | 005 The interface has removed the control enable 015 of a moving axis 025 035 |
| 1 2 3 4 | 102 The velocity command value is too high 112 The trigger is set with 122 machine data 354 132 |
| 1 2 3 4 | 101 Clamping error 111 Axis is not in position 121 The trigger is set with machine data 110 ... 113 131 |
| 1 2 3 4 | 103 Contour monitor 113 Trigger is set with machine data 351 and 352 123 133 |
| 1 2 3 4 | 104 Control loop hardware fault 114 The monitor of the position loop signal has tripped for the 124 axes, respectively spindle 134 |
| 1 2 3 4 | 108 Position control fault, contamination 118 128 138 |

The following signals are also necessary for manual runs (no alarm trigger) :







| | | |
|------------------------------|---|---------------------------|
| Feed release | } | Interface test, section 8 |
| No axis lock | | |
| Control enable X, Y, Z, 4th. | | |

After activating the direction key, if the feed release and control enable have not been given, the "Feed hold" lamp on the operating panel lights up.

5.5 Drift Compensation

The drift compensation should be made when the control loop is closed for all the axes, and the drives are under control. If this is not done, the axes may not move (indicator light "Machine running"  stays on.)

Procedure :

| | |
|---|----------------------|
|  | MDI-TE-SE |
|  | TEST |
|  | or |
|  | on Nr. 230 ...233 |
|  | Enter |
|  | EDIT |

Important : The drift compensation must be done for each axis individually. The data safety switch may be left in its normal position.

5.6 Testing all Manual Functions

Limit switch

Increment

Reference point approach

5.7 Running a Program

Here, only the principle programs must be tested, so that programs may be utilized as optimization aids.

The following interface signals are also necessary for this purpose :

" Read Enable " ,

and, under specific order from the interface only :

" NC Start" .

If the feed release is interlocked in the interface with the spindle speed, tool number input, auxiliary function input or others, then this output ought to be possible.

Check whether axes movement is possible through the program memory.

6 Drive Optimization, Drive Monitor, and Finishing Touches

Contents

- 6.1 Tacho Adjustments and Definition of the Maximum Command Value
- 6.2 Mult-gain Factor
- 6.3 Position Control Loop Gain (Kv Factor)
- 6.4 Acceleration
- 6.5 Cut-off Feed Rate
- 6.6 Position Monitors
- 6.7 Contour Monitor
- 6.8 Analogue Spindle Speed
- 6.9 Finishing Touches

6.1 Tacho Adjustment and Definition of the Maximum Command Value

The axis-specific maximal velocities Test-nr. 130 - nr. 133 selected by the customer, must be associated to a particular tacho voltage.

Keep in mind, that another 10 % control reserve will be needed here.

The natural limits are determined by the position control board (10 V) or the servo control of the drive.

Case A :

The maximal allowed input voltage for the drive-servo unit : ≥ 10 V.
Value 2048 is entered in Test nr. 140 - 143 (up to 10 V can be entered for the velocity command value; 2048 VELO = 10 V).

The maximal axis velocity must, however, be reached at 9 V already (10 % needed as control reserve).

Tacho Adjustment

The adjustment should be made at low velocity and low velocity command values.

Measuring point : the velocity command value at the drive's servo unit, with a defined velocity (e.g. manual) generated by the NC. Adjustment at potentiometer, tacho adjustment at the control.

Case B :

The servo unit of the drive must be limited to a velocity command value voltage of less than 10 V.

Value 1024 is entered, for example, in Test nr. 140-143 (the maximum command value input is 5 V).

The maximal axis velocity must be reached at 4 V (for tacho adjustment see Case A).

The velocity command value voltage can be limited by the NC via the machine datum Test nr. 140 - 143.

Conversion : 10 V correspond to approximately 2048 units (VELO).

The limitation entered under Test nr. 140 - 143 may not be reached during operation.

Since higher command value voltages result in better control behavior, it is generally preferable to use case A if possible.

6.2 Multi-gain Factor

Test nr. 220 - nr. 223

A multi-gain factor must be entered for the calculation of the velocity command value.

This allows axes to be driven with different maximal velocities, while using the command value input fully.

Axes which move jointly in contouring modes, must have equal position control loop gains. Such will be the case, if the value for each axis is derived according to the following formula :

$$\text{MULTGAIN} = \frac{3 \cdot 10^7}{V_{\text{max}} \left[\frac{\text{mm}}{\text{Min}} \right]} \cdot \frac{U_{\text{max}} [\text{V}]}{10 [\text{V}]}$$

For rotary axes :

$$\text{MULTGAIN} = \frac{3 \cdot 10^7}{V_{\max} \left[\frac{\text{Grad}}{\text{Min}} \right]} \cdot \frac{U_{\max} [\text{V}]}{10 [\text{V}]}$$

In inches (input system $\frac{1}{2} \cdot 10^{-4}$ in)

$$\text{MULTGAIN} = \frac{3 \cdot 10^7}{V_{\max} \left[\frac{\text{inch}}{\text{min}} \right]} \cdot \frac{U_{\max} [\text{V}]}{10 [\text{V}]}$$

V_{\max} = Maximal axis velocity, as set under Test nr. 130 - nr. 133
(maximum velocity)

U_{\max} = Velocity command value voltage for V_{\max} after tacho adjustment

Table for Mult-gain Input Values :

| $\frac{V_{\max}}{\text{Min}}$ | U_{\max} | | | |
|-------------------------------|------------|-------|-------|-------|
| | 4 V | 5 V | 8 V | 9 V |
| 15 | | 1000 | 1600 | 1800 |
| 14 | | 1071 | 1714 | 1929 |
| 13 | | 1154 | 1846 | 2077 |
| 12 | | 1250 | 2000 | 2250 |
| 11 | | 1354 | 2182 | 2455 |
| 10 | | 1500 | 2400 | 2700 |
| 9 | | 1667 | 2667 | 3000 |
| 8 | | 1875 | 3000 | 3375 |
| 7 | | 2143 | 3429 | 3857 |
| 6 | | 2500 | 4000 | 4500 |
| 5 | | 3000 | 4800 | 5400 |
| 4 | | 3750 | 6000 | 6750 |
| 3 | | 5000 | 8000 | 9000 |
| 2 | | 7500 | 12000 | 13500 |
| 1 | 12000 | 15000 | 24000 | 27000 |
| 0.8 | 15000 | 18750 | 30000 | 32000 |
| 0.75 | 16000 | 20000 | 32000 | |
| 0.6 | 20000 | 25000 | | |
| 0.5 | 24000 | 30000 | | |
| 0.4 | 30000 | 32000 | | |

Examples :

- a) Kv factors of all axes = (X, Z=1 m/min/mm)
 Maximum velocity of all axes = (X, Z=10 m/min)
 Command value correction of all axes = (Umax X, Z=8 V)
 i.e. mult-gain for all axes = (X, Z=2400)
- b) Kv factors of all axes = (X, Z=1 m/min/mm)
 Maximum velocity of all axes ≠ (X=10 m/min, Z=15 m/min)
 Command value corrections for all axes = (Umax X, Z=8 V)
 i.e. mult-gain for all axes ≠ (X=2400, Z=1600)
- c) Kv factors of all axes = (X, Z=1 m/min/mm)
 Maximum velocity of all axes ≠ (X=10 m/min, Z=15 m/min)
 Command value corrections for all axes ≠ (Umax X=4 V, Z=8 V)
 i.e. mult-gain for all axes = or ≠ (X=12000, Z=1600)

6.3 Position Control Loop Gain (Kv Factor)**Definition :**

$$K_v = \frac{\text{Velocity}}{\text{Following Error}} \left[\frac{\text{m/min}}{\text{mm}} \right] \quad (\text{Kv unit according to VDI standards})$$

Generalities :

To keep contour deviations to a minimum during contouring operations, it is necessary to have a large Kv factor value. Kv values that are too high however, lead to instability, overshoots, and finally, to inadmissibly high machine loads (wear).

The maximum allowed Kv factor value depends on :

Design, respectively rapidity of the drives (control response time, acceleration/deceleration ranges), and quality of the machine.

In practice with production machines, such values have been found empirically to lie within 1 and 1.5 m/min/mm, in 80% of the cases. In these cases, the empirically found value should be set and tested with checks of possible instability or overshooting.

Important : A good velocity control optimization is always the prerequisite for a correct adjustment of the Kv factor.

Procedure :

Lower the acceleration (TEST nr. 120 - 123).

The overshoot behavior is the determining factor in the estimation of the Kv value. For this reason, the acceleration should not be set so high as to allow the drive to reach its current limit.

If the drive is to achieve an acceleration of 1 m/sec^2 , as a precaution, it is better to halve this value :

$$0.5 \text{ m/sec}^2 \Rightarrow \text{input} : 50$$

Kv Value Adjustment

The position control loop gain is entered under TEST nr. 150 - 153 according to the following conversion formula :

$$\begin{aligned} K_V (0.01 \text{ s}^{-1}) &= \frac{5000}{3} \cdot K_V \frac{\text{m/min}}{\text{mm}} \\ &= 1666 \cdot K_V \frac{\text{m/min}}{\text{mm}} \end{aligned}$$

Thus, the numerical value 1666 is entered for a Kv factor of 1.

To determine a proper positioning behavior and the maximum value, it is advisable to select the axis, used in the contouring operation, which shows the poorest dynamic behavior. The command value voltage n_{comm} at the velocity control should be measured with a storage oscilloscope or a ink-jet recorder. The machine should move at maximum feed rate.

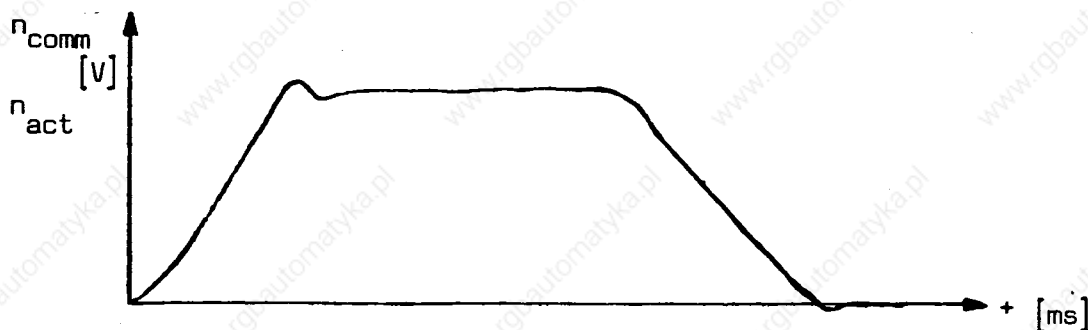

Since overshooting is observed, the Kv factor must be too high.

In most cases overshooting can already be detected from the following error (TEST nr. 800 - 803).



The Kv factor is low enough, so that no overshooting occurs.

This can be double-checked by observing the deceleration on the oscilloscope or ink-jet recorder, with higher vertical amplification.

The following factors can also cause overshooting :

Acceleration is too high (the current limit is reached).

Control response time of the velocity control loop is too long.

Velocity control error (reoptimization may be necessary).

Mechanical backlash.

Skewing in the mechanical portion.

Load changes (vertical axes).

As a precaution, it is advisable not to select the highest possible Kv factor, but a value that is at least 10% lower than that.

Axes which participate together in contouring processes, must have the same Kv factor.

Testing the Position Loop Gain (Kv Factor)

The magnitude of the following error can be determined under TEST nr. 800 - 803. If the drift has been compensated for, the value displayed for positive and negative directions at equal velocities will be the same.

Finally, the Kv factor value set for all axes must be checked during driving, over the display of the following error. The accuracy of contouring operations is based on identical dynamic behaviors of all axes, i.e. at the same velocity, the following error must be the same. If there are any deviations, the differences in multi-gain factors or velocity control must be adjusted.

6.4 Acceleration TEST Nr. 120 - 123

The axes are accelerated and decelerated with the values entered :

$$a \left| 10^{-2} \frac{\text{m}}{\text{sec}^2} \right|$$

This makes it possible to accelerate to velocity and decelerate into position rapidly, accurately, and with no undue strain on the machine.

The customer should provide information concerning the machine's proper continuous brake deceleration. This value, if the machine is not overloaded, should be entered under TEST nr. 120 - 123.

Generally, these values lie between :

$$0.3 \left| \text{m/sec}^2 \right| \quad \text{and} \quad 2 \left| \text{m/sec}^2 \right|$$

Check, respectively determination of the acceleration values :

Criterion :

TEST nr. 120 - 123 : acceleration without overshoots, respectively positioning at rapid traverse rate (maximum velocity).

Under worst-case load conditions (heavy workpiece on table) :

Instruments : chart recorder or storage oscilloscope

Measurements: velocity command value,
and possibly
current actual value and
velocity control output.

After setting the acceleration, the machine is run at rapid traverse rate, and the current actual values, and possibly the velocity control output, are recorded. From these measurements, it is possible to see whether or not the current limit was reached. The drive may reach this limit momentarily, but only in the rapid traverse range. For an interval before positioning, the drive must again be within velocity control, because the axis will otherwise overshoot its position.

Example of 6-pulse circulating current-free feed drive with current limitation control :

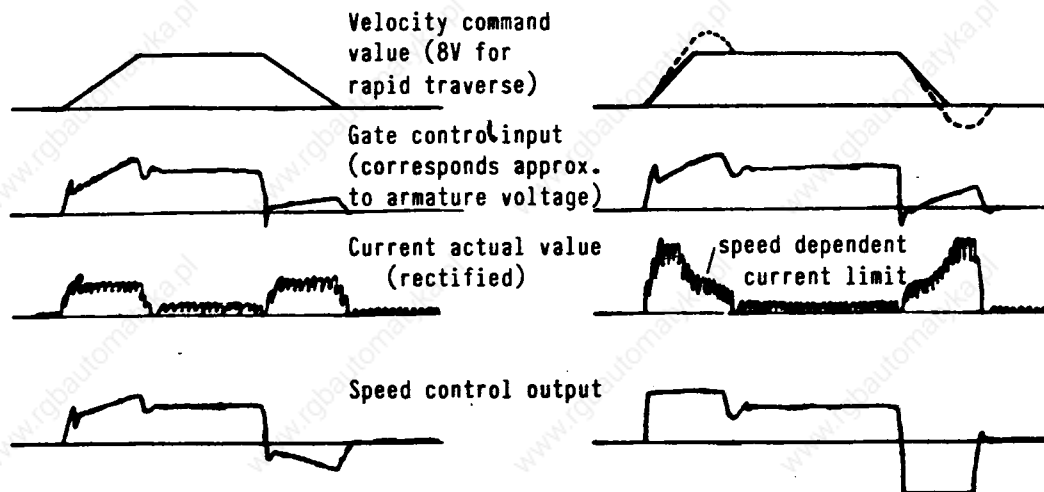

Example 1 : well selected acceleration

Example 2 : acceleration is too high ;
the current limit is reached.
Due to the larger following error, the command value overshoots within the position control loop.

The acceleration value entered should be at least 10% lower than the ideal value, in order to avoid reaching the current limit following only slight load changes (such as may result due to heavy spots or lube effects).

To protect the mechanical parts, the customer may want to set this value even lower than that.

The axes can have different acceleration values.

6.5 Cut-off Velocity

TEST Nr. 350

For reference point approach and positioning out of higher velocities, it is necessary to select an appropriate velocity.

Recommended values :

Nr. 350 S 500 mm/min

6.6 Position Monitors

TEST Nr. 100 - 103 , Position Tolerance

The approached position is checked after the dwell time for position monitoring TEST nr. 353 has elapsed. If at this time the following error is larger than the value entered under TEST 100 - 103, the ^{LED} "Machine not in position"  remains on; further motion is inhibited.

Setting :

The in-position accuracy depends on the quality of the position control and velocity control loops.

Normal deviations can be determined by monitoring the following error at standstill.

According to the customer's request and the positioning accuracy reached, the setting value should lie between 10 μm and 50 μm , but it should be at least twice as high as the maximum deviation of the following error at standstill.

TEST Nr. 110 - 113

Alarms 101, 111, 121, 131 are displayed, if, after the elapse of TEST 353, one of the axes is pushed out of position at standstill (clamping and control inhibit). The machine manufacturer has the task of keeping this deviation very low, if possible below the position tolerance set under TEST nr. 100 - 103. The clamp limit under TEST 110 - 113 should be set at twice the value under TEST nr. 100 - 103.

Recommended value :

TEST nr. 110 - 113 between 50 μm and 200 μm .

This also applies if none of the axes are clamped.

This locks the control (control inhibit) if the position control loop is faulty (drifting).

TEST NR. 353 Dwell Time for Position Monitoring

This machine datum affects the clamping limit determined for TEST nr. 110 - 113 (see the machine data description ,chapter 11).

If the clamp limit is checked too early (some following error still present) or if the drive overshoots,alarms 101, 111, 121,and 131 may be triggered.

The time interval set under TEST nr. 353 must be sufficiently large to allow the drive to come to a complete stop before the clamp limit is checked.

TEST nr. 353 is entered in 1 ms units.

Reasonable values are between 160 and 1600 ms.500 is considered the standard value.

6.7 Contour Monitoring

Contour monitoring functions according to the following principle :

After an acceleration or deceleration process,the following error of a position controlled axis remains constant.Load changes of the drive (e.g. due to interrupted or heavier cuts), are controlled by the velocity control (PI behavior).At constant command velocity,changes in following error occur only when the velocity control reaches a limit due to drive overloads,e.g. if tools break.This change is used as criterion for triggering the contour monitoring.A tolerance range is established for the maximum allowed following error,in order to avoid triggering the contour monitor unnecessarily following slight speed changes,as would be caused e.g. by motor slot ripples.There also is a dwell time after any velocity change, which must elapse before the contour monitoring can be activated.The width of the tolerance range and this delay interval are inversely proportional to the position loop gain.

Accurate contouring processes require that all axes which participate in the interpolation motions have the same position loop gain setting. Besides being set as machine data in the NC TEST nr. 150.. = Kv and TEST nr. 220.. = MULT-GAIN, the position loop gain is also determined by the tacho adjustment of the speed control, the actual value mult-gain factors, the gear ranges, etc.

For this reason, the contour monitor is provided with a Kv computation. The position loop gain is calculated from the command velocity and the resulting following error. This calculation is executed at the velocity ($\pm 25\%$) set under TEST nr. 371 (manual feed rate). The corresponding axis must hereby run at constant velocity for at least 3 seconds. The computed Kv value is displayed under TEST nr. 850.., in units of $\frac{\text{m/min (velocity)}}{\text{mm (following error)}} \cdot 1000$. This dimension is known and commonly used by machine tool manufacturers; usual values are between 500 and 1800. The calculated Kv value is cleared every time a machine datum is changed. After the Kv values have been calculated for all axes concerned, their equality will be checked. If the deviation is larger than 50, alarm 527 (Unequal Kv factors) will be triggered. This alarm is also displayed if any machine datum is changed. The machine can thus be operated without alarm display. (There are machines, which have to operate with unequal Kv factors, e.g. for rotary axes.) After power-up or machine data changes, ALARM 528 will indicate if any Kv factors have not been computed. The once determined Kv factors will remain for as long as no machine data are changed.

Machine data TEST nr. 351 and TEST nr. 352 can be used to modify the contour monitoring.

The velocity at which the contour monitoring becomes active is entered in mm/min under TEST nr. 351. At axis standstill, the contour monitor will not be active even after an input of 0. The standstill monitor checks in such cases for inadmissible axis movements.

The tolerance range for allowed contour deviations is entered under TEST nr. 352. This process also takes into account the calculated Kv factor, so that the tolerance band is derived according to the following formula :

$$\frac{\text{TEST nr. 352} \cdot 125}{K_v \cdot 1000} = \text{Tolerance band } (\mu\text{m})$$

Value 2000 is automatically entered with input 0. Thus, for Kv = 1 for example, the resulting tolerance band will be 250 μm, for Kv = 2, 125 μm, etc .

The actual contour deviations can be displayed with TEST nr. 840... .

If the position command value is changed, the contour monitor becomes inactive. This renders any contour monitoring inactive during circular interpolations. In order to protect the machine even in these cases, the signs of the following error, position command value and position actual value are continuously compared with each other. After the elapse of the Kv dependent safety time, if disparities have been found, the contour alarm (alarm 506) will be triggered.

6.8 Analogue Spindle Speed

The output for the analogue spindle speed command value is on the position control board 03 320. This value can be displayed under TEST nr. 860 ; the unit is VELO (2048 velo = 10 V).
 or ^{-325, -350} 8192 " = "

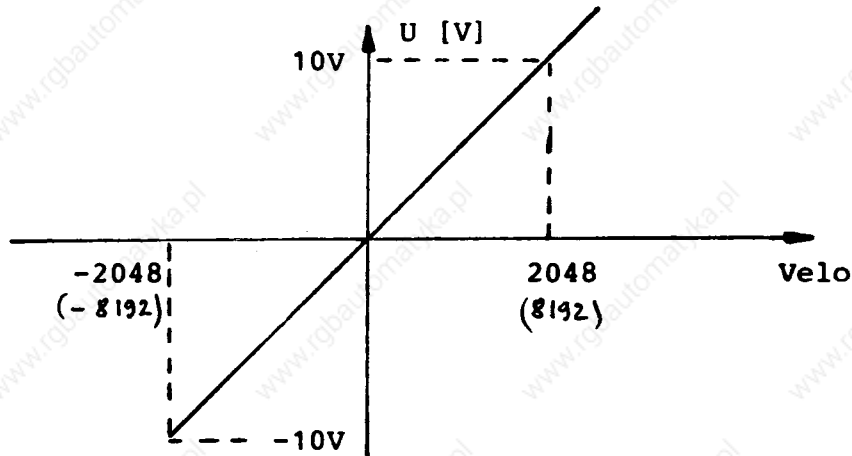

The conversion of the command value, taking into consideration the gear range, is done by the control with the use of the maximum velocity, which is entered under TEST nr. 359 - nr. 364. This input value (in rpm) must always correspond to the same motor speed (and thus to the same command value voltage U). For the set maximum spindle speed, when programming this speed and gear range, the control outputs 2048 units (approximately 10 V).

NOTE : The gear range must be acknowledged by the interface.

Example : 3 gear ranges

| TEST | Gear range | TEST nr. 8 Byte 4 Input Signals | | |
|----------------|------------|------------------------------------|---|---|
| | | C | B | A |
| Nr. 359 S 1000 | 1 | 0 | 0 | 0 |
| Nr. 360 S 2000 | 2 | 0 | 0 | 1 |
| Nr. 361 S 3000 | 3 | 0 | 1 | 0 |
| Nr. 362 S 3000 | 4 | 0 | 1 | 1 |
| Nr. 363 S 3000 | 5 | 1 | 0 | 0 |
| Nr. 364 S 3000 | 6 | 1 | 0 | 1 |
| Nr. 365 S 3000 | 7 | 1 | 1 | 0 |
| Nr. 366 S 3000 | 8 | 1 | 1 | 1 |

For only 3 gear ranges, S Ø can be entered for nr. 362 - 366 ; the codes for gear ranges 4 through 8 may hereby not be used for input signals.

TEST Nr. 377 Minimum Motor Speed

TEST nr. 377 determines the lowest admissible speed of the motor, by limiting output voltage in VELO. A drift of the speed control can be compensated for through the input of a compensation value under TEST nr. 357. This is done by commanding a low speed ; the speed must be the same in both directions.

6.9 Finishing Touches

6.9.1 Function Tests with NC Test Program

For testing the following functions :

Actual value display

Data display

All S, T, M-functions

Single block, deletable blocks, program-stop

Program memory

Tool offsets

Thread

Data input

Data output

The program and the tape should be produced by the machine manufacturer.

6.9.2 Generating a Machine Data Tape

There are several possibilities :

- a) A tape of the data entered during the start-up can be created out of the TEST memory, using a tape punch. For the operation sequence, see the service manual, section 2.
- b) A tape can also be generated on a separate programming device.

The tape should be placed by the control. The printout of the tape, or the list filled out according to section 1.2, should be filed into the log book.

If subsequently changes are made in machine data, a new tape and printout must be produced. After the start-up is finished, the service switch should be returned to its normal position (S3 on the front plate of the CPU, down = inactive position), in order to prevent inadvertent machine data changes.

The loading of standard machine data, change of machine data, and the handling of machine data tapes are described in sections 4.4 through 4.7 .

6.9.3 Machine Data Tape with Machine Standard Data

A machine data tape must be created for each machine; such a tape could then be used as standard tape for other machines of the same type. Individual data, e.g. drift values, grid point shifts, must however be derived and entered for each particular machine.

A "data gathering" scheme can be found on the first pages of the service manual, in section 1.

This scheme also includes a set of short explanations; more extensive information is given in section 11 (Machine data description).

For machine data tape inputs :

SEE SECTION 4.6

A new drift compensation must be made (according to section 4.6.4) after loading the machine data tape.

6.9.4 Brief Instructions to the Customer

The operators and maintenance personnel who will be dealing with the numerical control should be given as much information as is possible during a start-up procedure.

The following will remain to be executed by the customer :

- a) the reference point adjustment ,
- b) determination of the backlash ,
- c) entering these derived values into the machine data memory, as well as the punching of a corresponding tape (respectively insertion into the already existing machine data tape) ,
- d) drift compensation (see section 4.6.4) .

The customer's personnel must be instructed concerning the input of these data, in order to make sure that things can be handled in the absence of service engineers.

6.9.5 Start-up Report

The service call must be filed in the log book.

The customer should confirm the completion of the start-up and the functionality of the control ; this acknowledgement should be included in the start-up report (form).

6.9.6 Check-list for the Log Book

Include the check-list, completely filled out according to section 1.1, in the log book.

7 Machine Data Description

Content

- 7.1 Generalities
- 7.2 Axis-specific Machine Data
- 7.3 Common Machine Data
- 7.4 Description of Machine Data Bits

EMPTY

7.1 Generalities

The machine data are entered into the TEST data memory. Input is possible only with the data safety switch S1 enabled. In versions 0 - 2, display is possible in all positions except D0/DI.

Overview :

| | |
|-----------|---|
| 100 - 223 | Axis-specific data for programmed axes |
| 350 - 393 | Data common for all axes, respectively for spindle and such |
| 400 - 419 | Machine data bits |

7.2 Axis-specific Machine Data

Data memory TEST

| Axis number | Ident-number | Addr. | Sign | Display/Input | | |
|-----------------|--------------|--|-------------|--|---|---------------------------------------|
| 1 | 100 | S | + | Position tolerance (exact stop limit) |  | |
| 2 | 101 | | | | | |
| 3 | 102 | | | | | |
| 4 | 103 | | | | | |
| | | Position control units | | Input limits | Increments | Units |
| Metric; degrees | | $\frac{1}{2} \cdot 10^{-3} \text{ mm}$ | \emptyset | 32 000 | 1 | $1 \mu\text{m}; 10^{-3} \text{ deg.}$ |
| Inch | | $\frac{1}{2} \cdot 10^{-4} \text{ mm}$ | \emptyset | 32 000 | 1 | 10^{-4} in |

The position is considered reached, when the axis reaches the command position \pm the set position tolerance (position approach).

Effects of monitoring :

If the command position is not reached within these limits, the position control lamp remains on, and further motion commands are inhibited.

Remedy : drift compensation.

Example : N100 S10

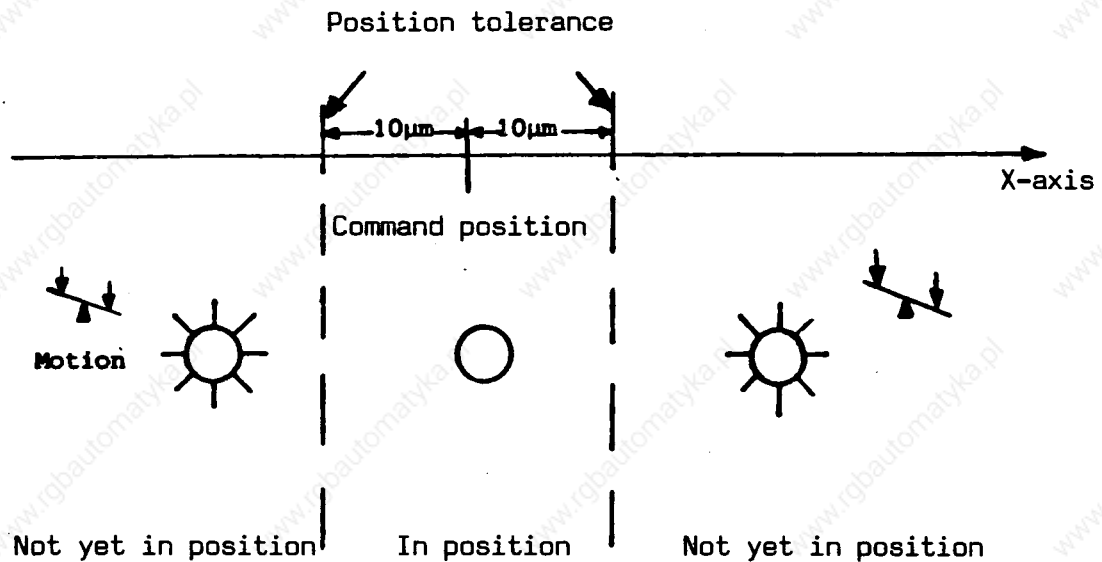

Note :

The position tolerance limit is only checked at G09, G00, G60, and single block. If it is not reached (under TEST 800...803S : check following error), the NC stops.

Data Memory TEST

| Axis number | Ident-number | Addr | Sign | Display/Input | | |
|-----------------|--------------|--------------------------------|--------------|--|------------|----------------------|
| 1 | 110 | S | + | Clamping tolerance and position control monitoring at standstill | | |
| 2 | 111 | | | | | |
| 3 | 112 | | | | | |
| 4 | 113 | | | | | |
| | | Position control units | Input limits | | Increments | Units |
| Metric; degrees | | $\frac{1}{2} \cdot 10^{-3}$ mm | ∅ | 32 000 | 1 | 1 μ m; 10^{-3} |
| Inch | | $\frac{1}{2} \cdot 10^{-4}$ mm | ∅ | 32 000 | 1 | 10^{-4} in |

The NC monitors the position at standstill (holding the position).

The following possibilities exist :

- a) If the interface control inhibits the control enable of an axis, it means that the NC does no longer hold that axis in position. The interface must hold the axis in position itself, through clamping. In such cases, the axis can be mechanically pushed out of position.
- b) The axis can be pushed out of position following high mechanical forces or drive malfunctions.

The clamping tolerance must be set higher than the position tolerance.

After the dwell time of the position monitor TEST nr. 353, if the clamping tolerance value is exceeded, alarms 101, 111, 121, 131 are displayed. If the alarm is triggered in the last block, it will be cleared immediately with M30.

Data Memory TEST

| Axis number | Ident-number | Addr | Sign | Display/Input | | |
|-----------------|--------------|--|--------------|---------------------|------------|---|
| 1 | 120 | S | + | Acceleration factor | |  |
| 2 | 121 | | | | | |
| 3 | 122 | | | | | |
| 4 | 123 | | | | | |
| | | Position control units | Input limits | | Increments | Units |
| Metric; degrees | | $\frac{1}{2} \cdot 10^{-3} \text{ mm}$ | ∅ | 6 000 | 1 | 10^{-2} m/s^2 ; $10 \frac{\text{deg}}{\text{s}^2}$ |
| Inch | | $\frac{1}{2} \cdot 10^{-4} \text{ mm}$ | ∅ | 2 400 | 1 | 1 inch/s ² |

The acceleration factor is set independently for each axis.

The values also apply to deceleration (for braking, see section 7.3).

The axes need not have the same acceleration values. In contour operations, the control always deals with the lowest acceleration value of the participating axes.

Remark : Values between 50...100 (= 0.5...1 m/s²) are common.

These values are inactive at thread ; the active value here is 358S.

Data Memory TEST
 =====

| Axis number | Ident-number | Addr | Sign | Display/Input | | |
|-----------------|--------------|--------------------------------|--------------|------------------|------------|---|
| 1 | 130 | S | + | Maximum velocity | |  |
| 2 | 131 | | | | | |
| 3 | 132 | | | | | |
| 4 | 133 | | | | | |
| | | Position control units | Input limits | | Increments | Units |
| Metric; degrees | | $\frac{1}{2} \cdot 10^{-3}$ mm | Ø | 15 000 | 1 | 1mm/min; 1deg/min |
| Inch | | $\frac{1}{2} \cdot 10^{-4}$ mm | Ø | 6 000 | 1 | 0.1 in/min |

The entered value represents the limit velocity to which the axis can accelerate (rapid traverse limit). The axis moves with this velocity when programed with rapid traverse G00.

Example :

Maximum velocity : X axis 12 m/min
 Y axis 12 m/min
 Z axis 10 m/min
 4th axis 4 m/min

If the machine is programed with 10 m/min by program, the axes will move as follows:

X axis 10 m/min
 Y axis 10 m/min
 Z axis 10 m/min _____ at limit nr. 132
 4th axis 4 m/min _____ with limit nr. 133

Example : Y and Z axes under 45°, with programed rapid traverse (15 m/min)

Both axes move with 10 m/min, which corresponds to 14.142 m/min contour velocity, because the Z axis has been limited to 10 m/min under nr. 132 .

| Axis number | Ident-number | Addr. | Sign | Display / Input | |
|-------------|--------------|-------|------|------------------------|---|
| 1 | 140 | | | Velocity command limit |  |
| 2 | 141 | S | + | | |
| 3 | 142 | | | | |
| 4 | 143 | | | | |

| Position control loop board | Input Limits | | Increments | Units |
|-----------------------------|--------------|-------|------------|-------------------------------|
| 03320 | 0 | 2 048 | 1 | 1 VELO 1= $\frac{10 V}{2048}$ |
| 03325/03350 | 0 | 8 192 | 1 | 1 VELO 1= $\frac{10 V}{8192}$ |

Note : Exceeding this limit results in IPO stop; the drive oscillates.

This input defines the maximum voltage value which can be produced as velocity command value (output voltage limitation through interpolation stop).

This voltage value should lie approximately 10% above the voltage for maximum velocity, so that overshoots can be controlled. For 9 V velocity command value for rapid traverse, the value should thus be 2048 or 8192 (for 10 V corresponding to 10% control reserve, also see section 7.3, machine datum 354).

Data Memory TEST

| Axis number | Ident-number | Addr. | Sign | Display / Input | |
|-------------|--------------|-------|------|--------------------|---|
| 1 | 150 | S | + | Position loop gain |  |
| 2 | 151 | | | | |
| 3 | 152 | | | | |
| 4 | 153 | | | Kv factor | |

| Input Limits | | Increments | Units |
|--------------|--------|------------|------------------------|
| 0 | 10 000 | 1 | 0.01 sec ⁻¹ |

Conversions :

$$Kv (0.01 \text{ s}^{-1}) = 1666 \cdot Kv \left(\frac{\text{m/min}}{\text{mm}} \right)$$

or

$$Kv (0.01 \text{ s}^{-1}) = 1666 \cdot Kv \left(\frac{\text{mm/min}}{\mu\text{m}} \right)$$

The position loop gain is axis-specific.

The values entered for axes which do not participate to contour operations may be different than those for axes that do participate in such processes

Axes which cooperate in contour operations must have the same Kv factor

(equal following error at equal velocity = 45°).

Data Memory TEST

| Axis number | Ident-number | Addr | Sign | Display/Input | | |
|-----------------|--------------|--------------------------------|--------------|-----------------------------------|------------|---|
| 1 | 160 | | | Software limit switch <u>plus</u> | |  |
| 2 | 161 | S | ± | | | |
| 3 | 162 | | | | | |
| 4 | 163 | | | | | |
| | | Position control units | Input limits | | Increments | Units |
| Metric; degrees | | $\frac{1}{2} \cdot 10^{-3}$ mm | ∅ | 99999999 ^{+))} | 1 | 1 μm; 10 ⁻³ degrees |
| Inch | | $\frac{1}{2} \cdot 10^{-4}$ mm | ∅ | 99999999 ^{+))} | 1 | 10 ⁻⁴ in |

Remark: +) input limit for versions 0 and 2, 9 999 999

The software limit switch can supplement the common limit switch. The absolute position of the positive range of each axis must be entered. The software limit switch becomes active only after reference point approach.

When the positive software limit switch is reached, alarms 1, 11, 21, 31 are displayed.

Note :

There are no input signals for hardware limit switches. These can only act through :

- Feed hold (unsuitable due to acceleration ramp)
- Drive inhibit (most advantageous due to speed stop via jump functions)
- Emergency stop (fast with jump functions, but unsuitable due to side effects)

Software limit switches are overrun despite the automatic reduction (see section 7.4). Overrun dependent on approach speed.

Data Memory TEST

| Axis number | Ident-number | Addr | Sign | Display/Input | | |
|-----------------|--------------|--|--------------|---------------------------------------|------------|---|
| 1 | 170 | S | ± | Software limit switch <u>minus</u> | |  |
| 2 | 171 | | | | | |
| 3 | 172 | | | | | |
| 4 | 173 | | | | | |
| | | Position control units | Input limits | | Increments | Units |
| Metric; degrees | | $\frac{1}{2} \cdot 10^{-3} \text{ mm}$ | ∅ | 99999999 +) | 1 | 1 μm ; 10^{-3} degrees |
| Inch | | $\frac{1}{2} \cdot 10^{-4} \text{ mm}$ | ∅ | 99999999 +) | 1 | 10^{-4} in |

Remark : +) input limits for versions 0 and 2, 9 999 999

The software limit switch can supplement the usual limit switch. The absolute position of the negative range limit of each axis must be entered. The software limit switch is activated only after reference point approach.

Alarms 2, 12, 22, 32 (depending on axis) appear when the negative software limit switch is reached.

Note :

The software limit switch becomes active only after the reference point of the corresponding axis has been approached.

Data Memory TEST

| Axis number | Ident-number | Addr | Sign | Display/Input | | |
|-----------------|--------------|--------------------------------|--------------|-----------------------------|------------|---|
| 1 | 180 | S | ± | Reference point coordinates | |  |
| 2 | 181 | | | | | |
| 3 | 182 | | | | | |
| 4 | 183 | | | | | |
| | | Position control units | Input limits | | Increments | Units |
| Metric; degrees | | $\frac{1}{2} \cdot 10^{-3}$ mm | ∅ | 99999999 +) | 1 | 1 μ m; 10^{-3} degrees |
| Inch | | $\frac{1}{2} \cdot 10^{-4}$ mm | ∅ | 99999999 +) | 1 | 10^{-4} in |

Remark:*)input limits for versions 0 and 2, 9 999 999

The difference between the absolute machine zero point and the fixed reference point is set for each axis. These values are entered as actual values at reference point approach.

Data Memory TEST

| Axis number | Ident-number | Addr | Sign | Display/Input | | |
|-----------------|--------------|--|--------------|-----------------------|---|-------------------------------------|
| 1 | 190 | | | Backlash compensation |  | |
| 2 | 191 | S | ± | | | |
| 3 | 192 | | | | | |
| 4 | 193 | | | | | |
| | | Position control units | Input limits | | Increments | Units |
| Metric; degrees | | $\frac{1}{2} \cdot 10^{-3} \text{ mm}$ | ∅ | 255 | 1 | 1 μm ; 10^{-3} degrees |
| Inch | | $\frac{1}{2} \cdot 10^{-4} \text{ mm}$ | ∅ | 255 | 1 | 10^{-4} in |

Backlash can be positive or negative; for this reason, a value of up to $\pm 255 \mu\text{m}$ is entered for each axis. The value must be positive for positive backlash, and negative for negative backlash.

Positive Backlash

(normal case)



The encoder actual value precedes the real actual value of the table

Negative Backlash

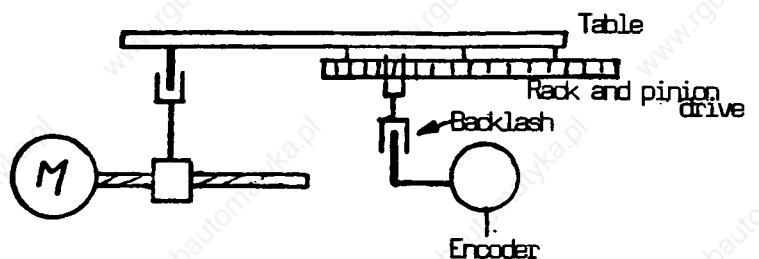

The real actual value of the table precedes the actual value of the encoder.

Data Memory TEST
=====

| Axis number | Ident-number | Addr | Sign | Display/Input | | |
|-----------------|--------------|--------------------------------|--------------|----------------------|------------|---|
| 1 | 200 | | | Tool reference point | |  |
| 2 | 201 | S | ± | | | |
| 3 | 202 | | | | | |
| 4 | 203 | | | | | |
| | | Position control units | Input limits | | Increments | Units |
| Metric; degrees | | $\frac{1}{2} \cdot 10^{-3}$ mm | ∅ | 99999999 +) | 1 | 1 μ m; 10^{-3} degrees |
| Inch | | $\frac{1}{2} \cdot 10^{-4}$ mm | ∅ | 99999999 +) | 1 | 10^{-4} in |

Remark:→input limits for versions 0 and 2, 9 999 999

For the automatic determination of the tool geometry, see the operating manual, section 8.1.7 .

(Automatic tool offset determination available only for 3T with option J12)

Data Memory TEST

| Axis number | Ident-number | Addr | Sign | Display/Input | | |
|-----------------|--------------|--|--------------|-----------------------|---|--------------------------------------|
| 1 | 210 | | | Reference point shift |  | |
| 2 | 211 | S | ± | | | |
| 3 | 212 | | | | | |
| 4 | 213 | | | | | |
| | | Position control units | Input limits | | Increments | Units |
| Metric; degrees | | $\frac{1}{2} \cdot 10^{-3} \text{ mm}$ | ∅ | 9 999 | 1 | $1 \mu\text{m}; 10^{-3} \text{ deg}$ |
| Inch | | $\frac{1}{2} \cdot 10^{-4} \text{ mm}$ | ∅ | 9 999 | 1 | 10^{-4} in |

The reference point of the position control system can be shifted with the reference point shift. Thus, instead of shifting the position coder mechanically (hence also the *DECELERATION cam), the reference point can be shifted electrically up to $\pm 9999 \mu\text{m}$.

Positive reference point approach direction :

If the input is positive, the axis moves beyond the reference point in positive direction (2000 μm after zero pulse).

Negative reference point approach direction :

If the input is negative, after approaching the zero pulse, the axis moves by the value resulting from the difference of 2000 μm + input value. For reference point shifts larger than ca. -2000 μm , after zero pulse approach the software recognizes that motion is in the wrong direction, and reverses it.

Example 1: Reference pt. shift *) positive

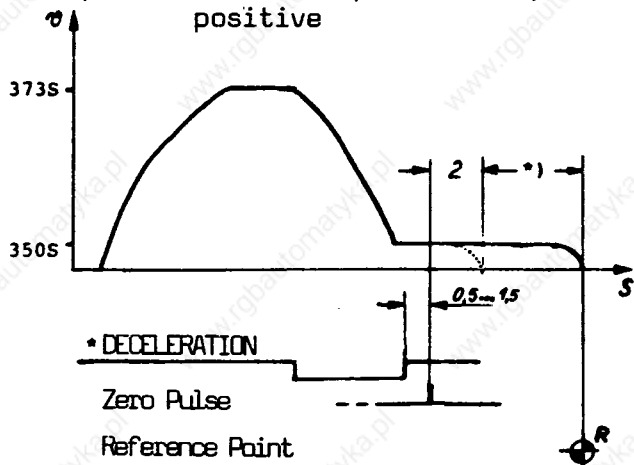

Example 2: Reference point shift *) negative, ca. -4.5 mm

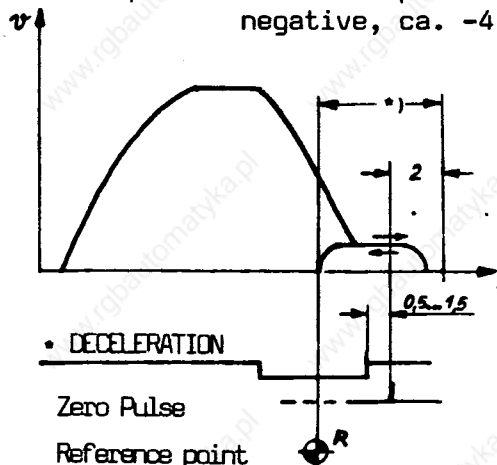

Reference point approach is possible even if the cam is on the deceleration switch.

Data Memory TEST

| Axis number | Ident-number | Addr. | Sign | Display / Input | |
|-------------|--------------|-------|------|--|---|
| 1 | 220 | S | + | Multiplication factor for the position loop gain |  |
| 2 | 221 | | | | |
| 3 | 222 | | | | |
| 4 | 223 | | | | |

| | Input Limits | Increments | Units |
|---|--------------|------------|---|
| 1 | 32 000 | 1 | $3 \cdot 10^7$ $V_{max} \langle \text{mm/min} \rangle$ |
| 1 | 32 000 | 1 | $3 \cdot 10^7$ $V_{max} 0.1 \text{ in/min}$ |

For accuracy, and because of the different conversion factors, this value must be entered as follows :

$$\text{MULT-GAIN}_{\text{input}} = \frac{3 \cdot 10^7}{V_{\text{max}} \frac{\text{mm}}{\text{min}}} \cdot \frac{U_{\text{max}} [\text{V}]}{10 [\text{V}]}, \text{ respectively}$$

$$\frac{3 \cdot 10^7}{V_{\text{max}} \frac{0.1 \text{ in}}{\text{min}}} \cdot \frac{U_{\text{max}} [\text{V}]}{10 [\text{V}]}$$

V_{max} = the maximum axis velocity as given under nr. 130 - 133, is entered as maximum velocity

U_{max} = command value voltage for V_{max} (tacho adjustment)

Example :

$$V_{\max} = 10\ 000\ \text{mm/min}; U_{\max} = 9\ \text{V}$$

$$\text{MULT-GAIN} = \frac{3 \cdot 10^7}{10000\ \text{mm/min}} = 2700\ [\text{min/mm}]$$

If the MULT-GAIN factors are entered in the described manner, the Kv factor set under N150-N153 corresponds to the value active on the machine, in the appropriate units.

MULT-GAIN Table - different input values



| $\frac{m}{\text{min}}$ | V_{\max} | | U_{\max} |
|------------------------|------------|-------|------------|
| | 4 V | 8 V | |
| 15 | | 1600 | 1800 |
| 14 | | 1714 | 1929 |
| 13 | | 1846 | 2077 |
| 12 | | 2000 | 2250 |
| 11 | | 2182 | 2456 |
| 10 | | 2400 | 2700 |
| 9 | | 2667 | 3000 |
| 8 | | 3000 | 3375 |
| 7 | | 3429 | 3857 |
| 6 | | 4000 | 4500 |
| 5 | | 4800 | 5400 |
| 4 | | 6000 | 6750 |
| 3 | | 8000 | 9000 |
| 2 | | 12000 | 13500 |
| 1 | 12000 | 24000 | 27000 |
| 0.8 | 15000 | 30000 | 32000 |
| 0.75 | 16000 | | |
| 0.6 | 20000 | | |
| 0.5 | 24000 | | |
| 0.4 | 30000 | | |

Inch System :

| inch/min | 9 v |
|----------|-------|
| 600 | 4500 |
| 500 | 5400 |
| 400 | 6750 |
| 300 | 9000 |
| 200 | 13500 |
| 100 | 27000 |

Data Memory TEST

| Axis number | Ident-number | Addr | Sign | Display/Input | |
|------------------------------|--------------|--------------|-------|--------------------|---|
| 1 | 230 | S | + | Drift compensation |  |
| 2 | 231 | | | | |
| 3 | 232 | | | | |
| 4 | 233 | | | | |
| Position control loop boards | | Input Limits | | Increments | Units |
| 03320 | | 0 | 500 | 1 | $VELD 1 = \frac{10 V}{2048}$ |
| 03325/03350 | | 0 | 2 000 | 1 | $VELD 1 = \frac{10 V}{8192}$ |

To eliminate analog drift values software-wise, it is possible through MDI, to bring the following error at standstill to zero. It is also possible to do an automatic drift compensation in the operation mode MDI-TE-SE and the TEST mode under nr. 230, using  . The compensation must be done for each axis individually.

If the values becomes larger than 100 (03320), respectively 400 (03325/03350) during automatic drift compensation, alarms 105, 115, 125 or 135 are displayed (see section 4.) .

7.3 Common Machine Data

Data Memory TEST

| Axis number | Ident-number | Addr | Sign | Display/Input | |
|-------------|--|--------------|--------|------------------|---|
| | 350 | S | + | Cut-off velocity |  |
| | | | | | |
| | Position control units | Input limits | | Increments | Units |
| Metric | $\frac{1}{2} \cdot 10^{-3} \text{ mm}$ | ∅ | 15 000 | 1 | 1mm/min, 1°/min |
| Inch | $\frac{1}{2} \cdot 10^{-4} \text{ in}$ | ∅ | 6 000 | 1 | 0.1 inch/min |

The velocity entered with 350S is active at :

- a) Positioning from program at cut-off feed rate.

The velocity selected for approaching the reference point and for cut-off from a higher velocity should allow proper positioning.

- b) Reference point approach, as long as the "Deceleration at reference point" signal is active.

351 S: Threshold Feed Rate for Contour Monitor

| 351 S | Position Control Units | Input Limits | Increments | Units |
|-----------------|--------------------------------|--------------|------------|------------|
| Metric, degrees | $\frac{1}{2} \cdot 10^{-3}$ mm | 0 - 15 000 | 1 | mm/min |
| Inches | $\frac{1}{2} \cdot 10^{-4}$ in | 0 - 6 000 | 1 | 0.1 in/min |

352 S: Tolerance Range for Contour Monitor

| 352 S | Position Control Units | Input Limits | Increments | Units |
|-----------------|--------------------------------|---------------|------------|---|
| Metric, degrees | $\frac{1}{2} \cdot 10^{-3}$ mm | 032 000 | 1 | $\frac{\text{mm} \cdot \text{TEST 850}}{125 \cdot 1000}$ |
| Inch | $\frac{1}{2} \cdot 10^{-4}$ in | 032 000 | 1 | $\frac{0.1 \text{ in} \cdot \text{TEST 850}}{125 \cdot 1000}$ |

The Kv value is determined (display TEST 850...853 in $0.01 \frac{\text{m/min}}{\text{mm}}$, normal values between 500 and 1800) only after at least 3 seconds of constant velocity. This remains stored until new machine data are entered. After the Kv has been determined for all axes (alarm 528 is otherwise triggered), an equality check is made. Deviations larger than 50 trigger alarm 527.

$$\text{Tolerance band derivation : } \frac{\text{TEST N352} \cdot 125}{K_V \cdot 1000} \quad [\mu\text{m}]$$

For further description of the contour monitoring, see section 6.7 .

| Axis number | Ident-number | Addr. | Sign | Display / Input | |
|-------------|--------------|-------|------|------------------------------------|---|
| | 353 | S | + | Dwell time for position monitoring |  |

Note :

Standard value :
500

| Input Limits | | Increments | Units |
|--------------|--------|------------|-------|
| 0 | 16 000 | 1 | 1 ms |

The entered dwell time is active at :

1. The clamping limit (nr. 110 - 113) becomes active during position approach (digital zero), only after the elapse of this dwell time. The interval selected must allow the largest following error to be reduced, without triggering alarms 101, 111, 121, 131 .
2. Delay time for the output of the control inhibit signal, after E-Stop and other faults which lead to an immediate stop of the axes motion.
3. Delay time for the output of the control inhibit signal, for cases in which the interface revokes the control enable of a moving axis.
4. Delay time for alarms 101...131 (standstill monitors), in cases where the maximum velocity command value has been exceeded (nr. 141 - 143).

Data Memory TEST

| Axis number | Ident-number | Addr. | Sign | Display / Input | |
|-------------|--------------|-------|------|---|---|
| | 354 | S | + | Velocity command value limit monitor (position control or drive fault) |  |

| Position control loop boards | Input Limits | | Increments | Units |
|------------------------------|--------------|--------|------------|-------------------------------|
| 03320 | 0 | 3 000 | 1 | 1 VELO 1= $\frac{10 V}{2048}$ |
| 03325/03350 | 0 | 12 000 | 1 | 1 VELO 1= $\frac{10 V}{8192}$ |

If the velocity command value generated is too high (position control or drive malfunction), this monitor triggers alarms 102, 112, 122, 132. The input value must be higher than the largest value set under nr. 140 - 143 as maximal velocity command value.

Recommendation : approximately 20 % higher

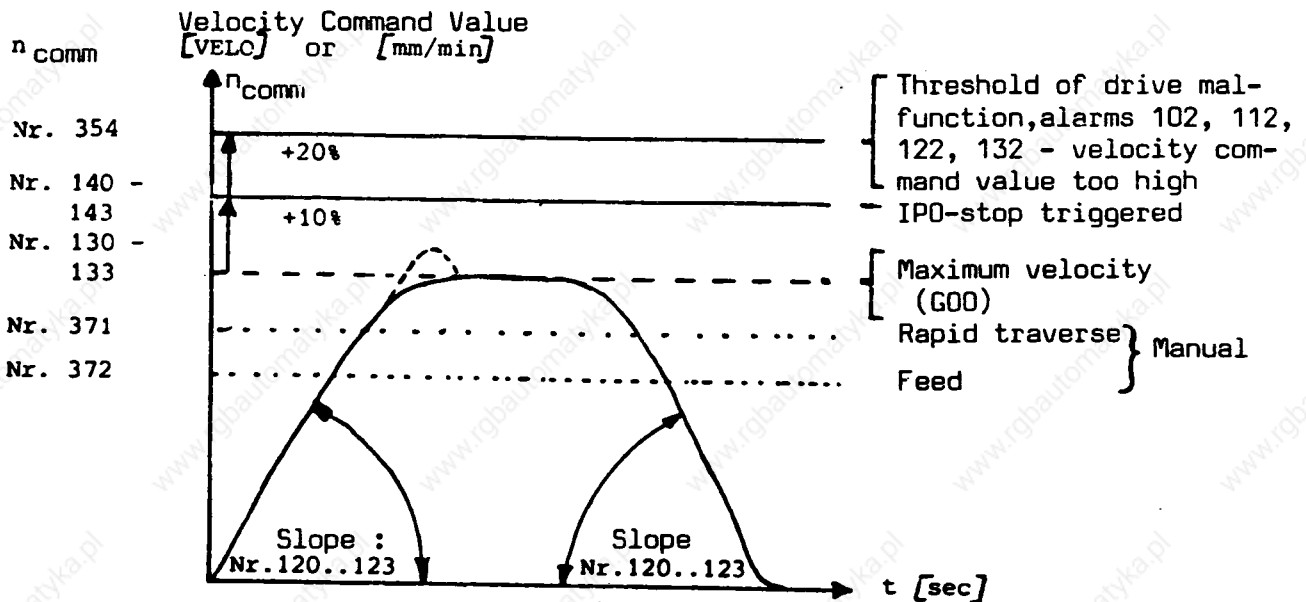

Data Memory TEST

| Axis number | Ident-number | Addr | Sign | Display/Input | |
|-----------------|--------------------------------|------------------------|--------------|--------------------------|---|
| | 355 | S | + | Circle end-point monitor |  |
| | | Position control units | Input limits | Increments | Units |
| Metric; degrees | $\frac{1}{2} \cdot 10^{-3}$ mm | \emptyset | 32 000 | 1 | 1 μ m, 10^{-3} degrees |
| Inch | $\frac{1}{2} \cdot 10^{-4}$ mm | \emptyset | 32 000 | 1 | 10^{-4} in |

The input value determines a ring (tolerance ring) equidistant to the programed circular arc, independently of the programed end-point. If the programed end-point lies within the tolerance ring, the machine will move along the incorrectly programed contour until the end-point can be radially approached. If the programed end-point falls outside the tolerance ring, this will be already recognized within the buffer, the block will not be released for machining, and alarm 308 will be displayed.

The same holds true if the radius is properly programed ($M=M'$), but the end-point is programed incorrectly.

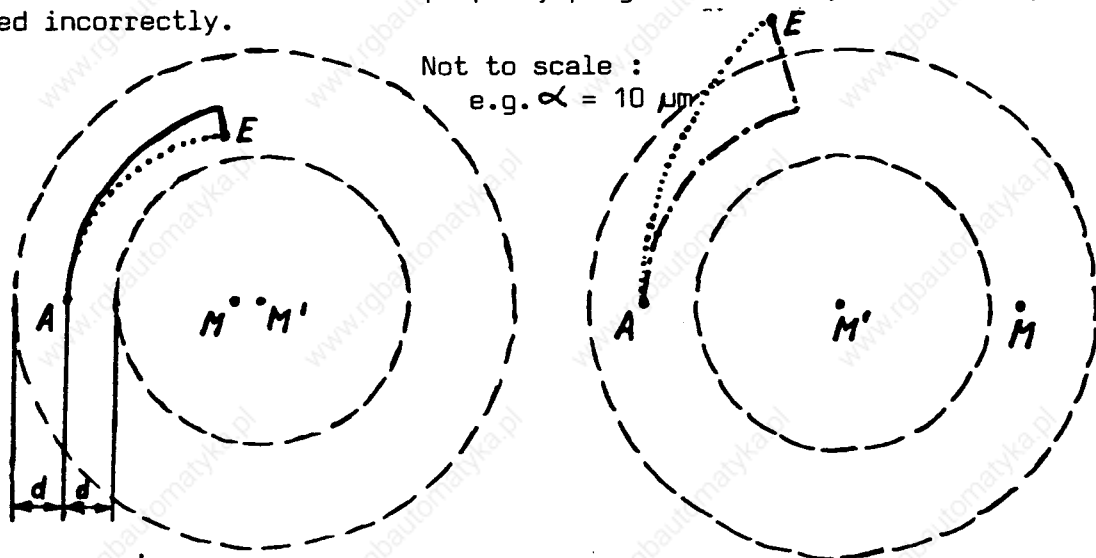

End-point within tolerance ring: machining, no alarm

--- tolerance ring limits
.... required contour (with M & E)
— actual contour (with wrong M')

End-point outside tolerance ring: no machining, alarm 308

A=start-point E=end-point (correct)
d=input value M=required center point

M' = programed center point (incorrectly programed parameter or R)

Data Memory TEST

| Axis number | Ident-number | Addr | Sign | Display/Input | |
|------------------------|--------------|--------------|--------|--|---|
| | 356 | S | + | Threshold for compensatory movements at cutter radius compensation (CRC) |  |
| Position control units | | Input limits | | Increments | Units |
| Metric; | | ∅ | 32 000 | 1 | 1 μm , 10^{-3} degrees |
| Inch | | ∅ | 32 000 | 1 | 10^{-4} inch |

For transitions from circular contours to linear contours or to further circular contours, 1 or several intermediate blocks are inserted (see programming instructions) for linear compensatory motion(s). During these compensation movements, the programmed feed rate for the machining of the work piece contour is maintained on the cutter radius center point. This results in feed rate differences. In order to prevent feed reductions over very small distances, the compensatory movements below threshold "d" should be minimized or omitted as follows :



For transitions with only linear interpolation, the threshold is inactive. Compensation movements are executed without exception (see the programming instructions).

----- Cutter center point
 ///// Contour deviation

$\Delta X1, \Delta Y1 < d$:

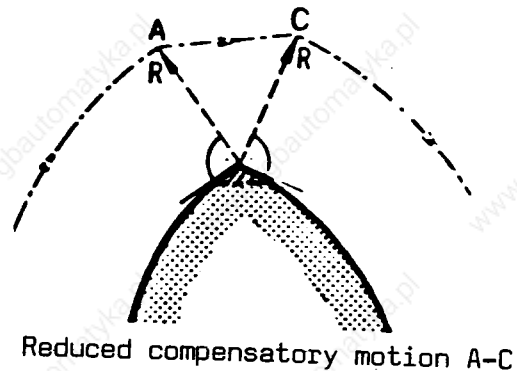

$\Delta X1, \Delta X2, \Delta Y1, \Delta Y2 < d$:

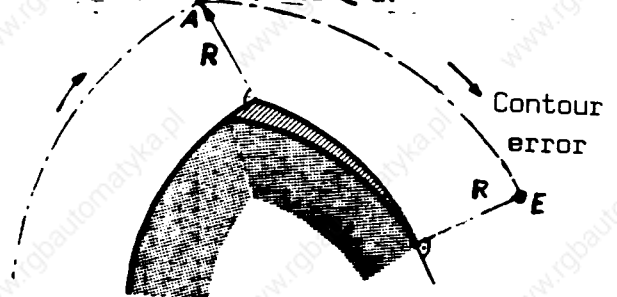

No compensation. Proper compensation is only reached at the end (E) of the block.

Data Memory TEST

| Axis number | Ident-number | Addr | Sign | Display/Input | | | |
|--|--------------|------|------|------------------------------------|-----|------------|------------------------------|
| Spindle | 357 | S | ± | Drift compensation for the spindle | | | |
| Output edition | | | | Input limits | | Increments | Units |
| 3T/M0-2 software 04, 05 3T/M3 software 01 | | | | 0 | 250 | 1 | VELO 2 = $\frac{10 V}{2048}$ |
| 3T/M0-2 software 06, 07 3T/M3 software 02, 03 | | | | 0 | 500 | 1 | VELO 2 = $\frac{10 V}{8192}$ |

This machine datum determines the drift compensation value for analog spindle speed output.

At small command values, this value must be changed in the respective direction, positive or negative, until the spindle's actual speed is equal for both turning directions.

358 S Dynamic Smoothing Exponent for Thread

| Input Limits | | Increments | Units |
|--------------|---|------------|------------------------|
| 0 | 5 | 1 | (2^x-1) up-date time |

This affects the feed drive's ramp time at thread cutting for the following purposes : - to achieve short lead-in distances for thread cutting,
- to compensate for the ramp time of the spindle.

The time base for this is the actual value up-date time, according to the following equation :

$$(2^x-1) \cdot \text{up-date time} \quad ; \quad (x = \text{input value})$$

| | | | | | | |
|--------------------|------|---|---------|---|----|----|
| Input value | 0 | 1 | 2 | 3 | 4 | 5 |
| Up-date time mult. | 0 | 1 | 3 | 7 | 15 | 31 |
| Ramp function | Jump | | R a m p | | | |

Data Memory TEST

| Axis number | Ident-number | Addr | Sign | Display/Input | |
|---------------------------|-------------------------------|--------------|-------|-----------------------------------|---|
| Spindle | 359 360 361 ⋮ 366 | S | + | Maximum spindle speed for 8 gears |  |
| Speed valuation | | Input limits | | Increments | Units |
| 1 - 9999 mm ⁻¹ | | 16 | 9 999 | 1 | min ⁻¹ |
| 0.1 - 999 m ⁻¹ | | 16 | 9 999 | 1 | 0.1 m ⁻¹ |

The machine data determine the individual spindle speeds of each of the 8 gears at 10 V command value. If no gears are present, the maximum allowed spindle speed is entered under 359, and ∅ is set under 360...366. If fewer than 8 gears are present, set ∅ where no gear value exists.

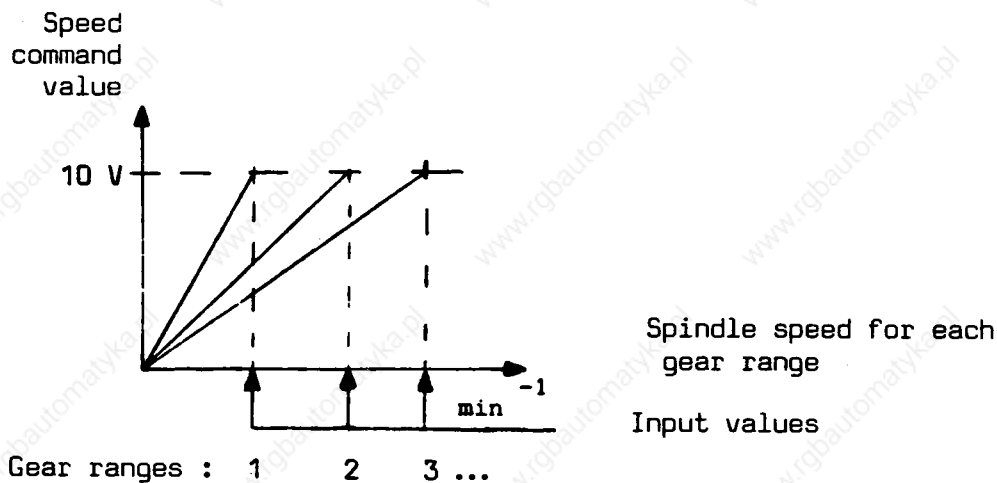

Designation:

| Gear range | 1 | 2 | 3 | 4 | 5 | 6 | 7 | 8 |
|--------------|-----|-----|-----|-----|-----|-----|-----|-----|
| Input number | 359 | 360 | 361 | 362 | 363 | 364 | 365 | 366 |

For the input signals of gear ranges, see section 8.
(Interface test input signals, 3 inputs for gear range code)

| Axis number | Ident-number | Addr | Sign | Display/Input | | |
|-----------------|--------------------------------|------------------------|--------------|---|--------------------|-------|
| | 371 | S | + | Manual feed | | |
| | | | |  | | |
| | | Position control units | Input limits | | Increments | Units |
| Metric; degrees | $\frac{1}{2} \cdot 10^{-3}$ mm | Ø | 15 000 | 1 | 1 mm/min; deg./min | |
| Inch | $\frac{1}{2} \cdot 10^{-4}$ in | Ø | 6 000 | 1 | 0.1 in/min | |

The input value determines the manual feed rate for all axes, unless the value is limited through the input under Test nr. 130 - 133, at 100% feed rate override.

Data Memory TEST

| Axis number | Ident-number | Addr | Sign | Display/Input | | |
|-----------------|--------------|--|--------------|----------------------------|------------|---|
| | 372 | S | + | Manual rapid traverse rate | |  |
| | | Position control units | Input limits | | Increments | Units |
| Metric; degrees | | $\frac{1}{2} \cdot 10^{-3} \text{ mm}$ | Ø | 15 000 | 1 | 1 mm/min; deg/min |
| Inch | | $\frac{1}{2} \cdot 10^{-4} \text{ in}$ | Ø | 6 000 | 1 | 0.1 in/min |

Unless limited through the input under Test nr. 130 - 133, the value entered determines the manual rapid traverse velocity for all axes, at 100% rapid traverse rate override. This value is not used with programmed rapid traverse G00.

The programmed rapid traverse G00 is determined by the maximum velocity set under Test nr. 130 - 133.

Data Memory TEST

| Axis number | Ident-number | Addr | Sign | Display/Input | | |
|-----------------|--------------|---------------------------------------|--------------|-----------------------------------|------------|---|
| | 373 | S | ± | Reference point approach velocity | |  |
| | | Position control units | Input limits | | Increments | Units |
| Metric; degrees | | $\frac{1}{2} \cdot 10^{-3} \text{mm}$ | ∅ | 15 000 | 1 | 1 mm/min; deg/min |
| Inch | | $\frac{1}{2} \cdot 10^{-4} \text{in}$ | ∅ | 6 000 | 1 | 0.1 in/min |

Unless limited through the input under Test nr. 130 - 133, the value entered is valid for all axes, at 100% feed rate override and rapid traverse override ON.

Data Memory TEST

| Axis number | Ident-number | Addr | Sign | Display/Input | | |
|-----------------|--------------|--|--------------|--|------------|-------------------|
| | 374 | S | + | Incrementing feed rate  | | |
| | | Position control units | Input limits | | Increments | Units |
| Metric; degrees | | $\frac{1}{2} \cdot 10^{-3} \text{ mm}$ | Ø | 15 000 | 1 | 1 mm/min; deg/min |
| Inch | | $\frac{1}{2} \cdot 10^{-4}$ | Ø | 6 000 | 1 | 0.1 in/min |

The entered velocity is active only during "increment" mode.

Resonable input values: up to 1000 $\frac{\text{mm}}{\text{min}}$.

Data Memory TEST

| Axis number | Ident-number | Addr | Sign | Display/Input | | |
|-----------------|--------------|--------------------------------|--------------|-------------------|------------|---|
| | 375 | S | + | Dry run feed rate | |  |
| | | Position control units | Input limits | | Increments | Units |
| Metric; degrees | | $\frac{1}{2} \cdot 10^{-3}$ mm | ∅ | 15 000 | 1 | 1 mm/min; deg/min |
| Inch | | $\frac{1}{2} \cdot 10^{-4}$ | ∅ | 6 000 | 1 | 0.1 in/min |

Unless limited axis-specifically by the input under nr. 130 - 133, the entered value is activated with the dry run  mode switch, and replaces the programed feed rate.

The feed rate override switch is active.

Whether or not the dry run switch is interlocked with the key switch depends on machine data bit nr. 410, bit 2.

Data Memory TEST

| Axis number | Ident-number | Addr. | Sign | Display / Input | |
|-------------|--------------|-------|------|-----------------------------------|---|
| Spindle | 376 | S | + | Dwell time for spindle inhibit *) |  |

| Input Limits | Increments | Units |
|--------------|------------|-------|
| ∅ 16 000 | 1 | ms |

After this dwell time has elapsed, a spindle command value of ∅ revokes the control enable (* control inhibit), which prevents the spindle from creeping.

This dwell time is active at :

- removal of the spindle enable signal ,
- M05
- E-stop
- activation of the position control monitor

Data Memory TEST

| Axis number | Ident-number | Addr. | Sign | Display / Input | |
|-------------|--------------|-------|------|-----------------------------|---|
| Spindle | 377 | S | + | Minimum spindle motor speed |  |

| Edition | Input Limits | Increments | Units |
|---------------------------------------|--------------|------------|-------------------------------|
| 3T/M0-2 ed.04&05 3T/M3 software 01 | 0 2 048 | 1 | 1 VELO 2= $\frac{10 V}{2048}$ |
| 3T/M0-2 ed.06÷08 3T/M3 ed. 02÷04 | 0 8 192 | 1 | 1 VELO 2= $\frac{10 V}{8192}$ |

This machine datum determines the minimum motor speed, below which the spindle should not go, e.g. at constant surface feed and increasing turning diameter. This means that from this point on, the surface speed is no longer constant, but increases with the turning diameter. The motor can run smoothly down to this speed.

Example :

Motor maximum speed = 3500 rpm, corresponds to the maximum spindle speed.

Motor minimum speed = (e.g.) 50 rpm

Input value : $\frac{50 \text{ rpm}}{3500 \text{ rpm}} \cdot 8192 = 120$

Data Memory TEST

| Axis number | Ident-number | Addr. | Sign | Display / Input | |
|-------------|--------------|-------|------|-------------------------------|---|
| Spindle | 378 | S | + | Cut-off spindle speed for M19 |  |

| Valuations | Input Limits | Increments | Units |
|---------------|--------------|------------|---------------------|
| 1 - 9999 rpm | 0 9999 | 1 | 1 min ⁻¹ |
| 0.1 - 999 rpm | 0 9999 | 1 | 0.1 m ⁻¹ |

This machine datum determines the spindle speed to which the spindle speed (M19) is reduced for spindle positioning, and with which the spindle moves until it is positioned with the set position control characteristic curve (see MD 379). Only for 3T/M, starting with software edition 02 and option E42.

Data Memory TEST

| Axis number | Ident-number | Addr. | Sign | Display / Input | |
|-------------|--------------|-------|------|---|---|
| Spindle | 379 | S | + | Gain factor for the position control loop (M19) |  |

| Speed Value MD 407 Bit 3 | Input Limits | | Increments | Units |
|-----------------------------|--------------|-------|------------|---|
| 0 | 0 | 10000 | 1 | $\frac{1/\text{min}}{360^\circ}$ |
| 1 | 0 | 10000 | 1 | $0.1 \frac{\text{min}^{-1}}{360^\circ}$ |

Recommended value : 50 to 500 - dependent upon performance of drive and speed controlles.

In oriented spindle stops (M19), the spindle is in closed position control loop. The gain factor is described by the positioning slope to the cut-off position. The slope is defined as the spindle speed (in rpm) at a position deviation of 360°.

Only for 3T/M 3, starting with software edition 02 and option E 42.

Data Memory TEST

| Axis number | Ident-number | Addr | Sign | Display/Input | |
|-------------|--------------|--------------|------|------------------------|---|
| Spindle | 380 | S | + | Position limit for M19 |  |
| | | Input limits | | Increments | Units |
| | | 0 | 1000 | 1 | 1/11 degree |

The position limit is entered in increments of the spindle encoder. One (1) increment represents 360/4096 degrees.

In oriented spindle stops (M19), the "POSITION APPROACHED" flag is outputted to the PC as soon as the position deviation is within these limits.

Only for 3T/M 3, starting with software edition 02 and option E 42.

Data Memory TEST

| Axis number | Ident-number | Addr. | Sign | Display/Input | |
|-------------|--------------|-------|------|------------------|---|
| | 381 | S | + | Software edition |  *) |

The software edition is written by the manufacturer into the EPROM, and is transferred to 381S with Power-On-Reset. (Input limits: 0... 32 000)

*) Values entered inadvertently can always be overwritten, and replaced with the value set in the PROM, with Power-On-Reset.

| Axis number | Ident-number | Addr. | Sign | Display/Input | |
|-------------|--------------|--------------|------|-----------------------|---|
| | 383 | S | + | Increase up-date time |  |
| | | Input limits | | Increments | Units |
| | | 0 30 | | 1 | ½ ms . |

Under normal circumstances, machine datum 383 is set to 0; the standard, fixed position control up-date time is active. It can, however, be increased with the use of this machine datum.

If the set up-date time (MD 383 = 0) is insufficient, it should be increased, but only after consulting GWE-TN4 (engineering).

Data Memory TEST

| Axis number | Ident-number | Addr | Sign | Display/Input | | |
|-----------------|--------------|--------------------------------|--------------|--|------------|---|
| | 384 | S | ± | 2nd. software limit switch in X (-) direction (only for 3T) (minus direction) | |  |
| | | Position control units | Input limits | | Increments | Units |
| Metric; degrees | | $\frac{1}{2} \cdot 10^{-3}$ mm | ∅ | ±9999 9999* | 1 | 1 um; 10^{-3} deg. |
| Inch | | $\frac{1}{2} \cdot 10^{-4}$ in | ∅ | ±9999 9999* | 1 | 10^{-4} in |

* In versions 0 and 2, the input limits are : ± 9 999 999

This 2nd. software limit switch is activated with a "high" ("H") signal (+ 24 V), on bit 6, input byte 3.

Data Memory TEST
=====

| Axis number | Ident-number | Addr | Sign | Display/Input | | | |
|-------------|--|------|------|---|---|-------|------|
| Spindle | 386 387 388 389 390 391 392 393 | S | * | Acceleration time constant for 8 gears |  | | |
| | | | | Input limits | Increments | Units | |
| | | | | ∅ | 32 000 | 1 | 4 ms |

For acceleration, the control generates the command value in the form of a ramp, in dependency of this machine datum. The MD acts like a variable ramp generator.

The setting is determined by measuring the time it takes to accelerate the motor from speed \emptyset to the maximum speed.

This time interval is entered as the machine datum, after unit conversion.

Only for 3T/M 3, starting with software edition 02.

Example :

Gear range 1

Acceleration time: 400 ms -- 386 S 100

Gear range 2

Acceleration time: 580 ms -- 387 S 145

7.4 Machine Data Bits Description

The individual machine data bits are described in the order of input numbers, and further, starting with bit 0 through 7. Under circumstances, several input numbers, respectively bits, are described jointly.

7.4.1 Address Designations

N400 Bit 0 - 3:

Address (name) for radii and chamfers to be inserted (see the programming instructions for 3T and 3M, section 6).

This address will also be used as address for tool nose radius (3T), respectively cutter radius (3M). (See Operating Instructions 3, section 8.1 .)

Normal designation for 3T: B
 3M: P

N401 Bit 0 - 3:

Address (name) for the coding of tool position (tool nose position), only for 3T, normally A (see programming instructions for 3T, section 4.2.2, and the operating instructions 3, section 8.1.1).

N402 Bit 0 - 3:

Address (name) of the 4th. axis, option A04, only for 3M (see the programming instructions 3M, section 2.1).

Address coding :

| Bit | | | | Name |
|-----|---|---|---|------|
| 3 | 2 | 1 | 0 | |
| 0 | 0 | 1 | 1 | A |
| 0 | 1 | 0 | 0 | B |
| 0 | 1 | 0 | 1 | C |
| 0 | 1 | 1 | 0 | U |
| 0 | 1 | 1 | 1 | V |
| 1 | 0 | 0 | 0 | W |
| 1 | 0 | 1 | 1 | P |

The bit combination determines the address character of the corresponding key: N400 bits 0 -3 for the  key (3rd. line, 4th. key), and N401 and 402 bits 0 - 3 for the 4th. key in the 2nd. line. When these keys are activated, the designated character appears in the display.

The same designation applies for programming (MDI or tape).

7.4.2 Time Settings

N400 Bits 4 - 7:

Time (duration) of strobe signal

N401 Bits 4 - 7:

Delay time for strobe signal

N402 Bit 4 - 7:

Duration for signals M02, M30 (program end)

Time setting
3T/M 0 and 2
software 04,05

| BIT 7 6 5 4 | Time [ms] | |
|----------------|-----------|-----|
| | 3T | 3M |
| 0 0 0 0 | 18 | 20 |
| 0 0 0 1 | 36 | 40 |
| 0 0 1 0 | 54 | 60 |
| 0 0 1 1 | 72 | 80 |
| 0 1 0 0 | 90 | 100 |
| 0 1 0 1 | 108 | 120 |
| 0 1 1 0 | 126 | 140 |
| 0 1 1 1 | 144 | 160 |
| 1 0 0 0 | 162 | 180 |
| 1 0 0 1 | 180 | 200 |
| 1 0 1 0 | 198 | 220 |
| 1 0 1 1 | 216 | 240 |
| 1 1 0 0 | 234 | 260 |
| 1 1 0 1 | 252 | 280 |
| 1 1 1 0 | 270 | 300 |
| 1 1 1 1 | 288 | 320 |

Time setting
3T/3M 0 and 2
software 06,07,08 and 3M/T3 01:04

| BIT 7 6 5 4 | Time [ms] | |
|----------------|-----------|-----|
| | 3T | 3M |
| 0 0 0 0 | 16 | 18 |
| 0 0 0 1 | 32 | 36 |
| 0 0 1 0 | 48 | 54 |
| 0 0 1 1 | 64 | 72 |
| 0 1 0 0 | 80 | 90 |
| 0 1 0 1 | 96 | 108 |
| 0 1 1 0 | 112 | 126 |
| 0 1 1 1 | 128 | 144 |
| 1 0 0 0 | 144 | 162 |
| 1 0 0 1 | 160 | 180 |
| 1 0 1 0 | 176 | 198 |
| 1 0 1 1 | 192 | 216 |
| 1 1 0 0 | 208 | 234 |
| 1 1 0 1 | 224 | 252 |
| 1 1 1 0 | 240 | 270 |
| 1 1 1 1 | 256 | 288 |

The times can be set in 16 steps, with 2-fold the up-date time *), common for all switch and auxiliary functions. The transfer of the switch and auxiliary functions to the interface control should be accomplished with the rising edge of the strobe signals.

The strobe signal and delay times are set in the same manner for the PC.

*) (actual value up-date time)

Example of a programming of M, S, and T-word in one block :

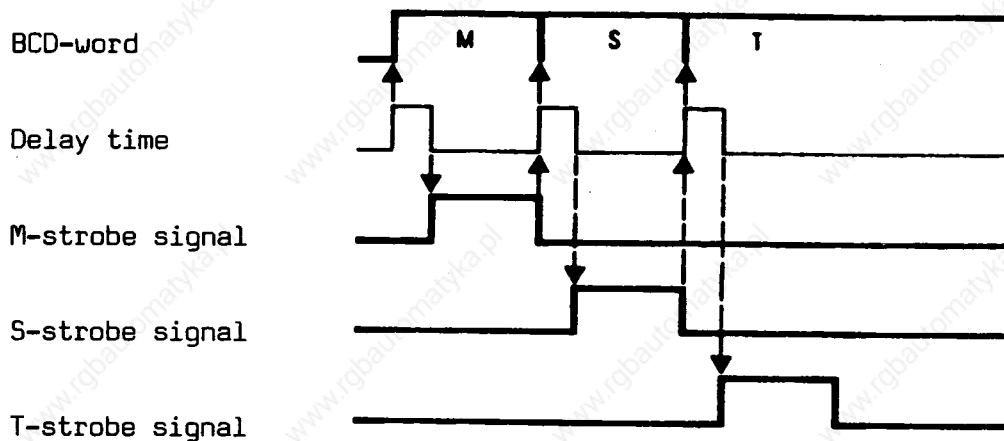

7.4.3 Reference Point Approach Direction (Axis-specific)

(Reference point approach in minus direction)

N403 through 406, bit \emptyset .

| Direction of approach | Bit \emptyset |
|-----------------------|-----------------|
| Minus | 1 |
| Plus | \emptyset |

7.4.4 Sign Change for Velocity Command Value, Partial Actual Value

(Axis-specific) : see also chapter 6.

N403 through 406, bit 1.

(Sign change for velocity command value)

| Velocity command value at positive axis motion | Bit 1 |
|--|-------------|
| Negative | 1 |
| Positive | \emptyset |

N403 through 406, bit 2:

(Sign change for partial actual value)

| | |
|---|-------|
| Positive partial actual value is calculated | Bit 2 |
| Negative | 1 |
| Positive | 0 |

7.4.5 Multiplication Factor for the Partial Actual Value (Axis-specific)

N403 through 406, bits 3 and 4 **and 6**.*

(Partial actual value to be multiplied, respectively divided, by 2 or 10)

Possible combinations:

| Factor | Bit 6 * | Bit 4 | Bit 3 |
|--------|---------|-------|-------|
| 1 | 0 | 0 | 0 |
| 0.5 | 0 | 1 | 0 |
| 2 | 0 | 0 | 1 |
| 5 | 1 | 1 | 0 |
| 10 | 1 | 0 | 0 |
| 20 | 1 | 0 | 1 |

With this factor, the increment resolution of the position control system is adapted to the interpolation resolution of the control. See the table on the next page.

For encoders with pulse numbers deviating from those given in the table, or for ball screws with different lead values, the adaptation must be done on the machine (e.g. through a gear).

* only for version 3, starting with software edition 03

| Linear axis | | | | | | | | | | Rotary axis |
|---|----------|----------|----------|----------|----------|----------|----------|--------|---------|--------------------------|
| Interpolator unit | 0.5 μm | | | | | | | | | 0.5 x 10 ⁻³ ° |
| Factor (Machine datum) | 1/2 | 1/2 | 1 | 1 | 2 | 2 | 1 | 2 | 1 | 2 |
| Resolution | 0.25μm | 0.25μm | 0.5μm | 0.5μm | 1μm | 1μm | 0.5μm | 1μm | 0.5μm | 1 x 10 ⁻³ ° |
| Pulse valuation of pos. control (input pulse is quadrupled) | 0.25μm/p | 0.25μm/p | 0.5μm/p | 0.5μm/p | 1μm/p | 1μm/p | 0.5μm/p | 1μm/p | 0.5μm/p | 1x10 ⁻³ °/p |
| Pulse valuation acc.to pulse shaper circuit | 1μm/p | 1μm/p | 2μm/p | 2μm/p | 4μm/p | 4μm/p | 2μm/p | 4μm/p | 2μm/p | 4x10 ⁻³ °/p |
| Pulse shaper circuit | - | - | - | - | - | - | - | 5-fold | 5-fold | 5-fold |
| Encoder pulse nr./rev. or grid constant | 200 | 2500 | 2000 | 2500 | 2000 | 2500 | 5000 | 20μm | 20μm | 18 000 |
| Max. encoder frequency per channel | 100KHz | 100KHz | 100KHz | 100KHz | 100KHz | 100KHz | 100KHz | 25KHz | 12KHz | 25KHz |
| Feed screw lead mm | 2 | 2.5 | 4 | 5 | 8 | 10 | 10 | - | - | directly |
| Vmax. of axis, dependent on encoder m/min | 6 | 6 | 12 | 12 | 24* | 24* | 12 | 30* | 15 | 30 000 °/min |
| Electrical encoder limit speed | 3000 rpm | 2400 rpm | 3000 rpm | 2400 rpm | 3000 rpm | 2400 rpm | 1200 rpm | - | - | 83.3 rpm |

* Travel velocity for rapid traverse = Vmax axis, however, maximum 15 m/min
The factor (machine datum) is set axis-specifically

Rotary encoder for linear axes 6FC9 320-3C

Table for the Selection of the Position Encoder

7.4.6 Rotary Axis

N403 through 406, bit 5 :

| Position control system programming | Bit 5 | Use |
|-------------------------------------|-------|-------------|
| Degrees | 1 | Rotary axis |
| mm or inch | 0 | Linear axis |

With this bit, after 256 revolutions, the actual value is reset to 0.

With this bit, the rotary axis is recognized with degree programming.

7.4.7 Exclude the Axis in the Start Interlock

N403 through 406, bit 7: -starting with software edition 07 for 3T/M 0 & 2

-starting with software edition 03 for 3T/M 3

The start interlock for individual axes can be excluded, even if 407 bit 7 was not set. For instance, 3M with only X and Y-axes; a short-circuit (*dummy*) connector must be installed for the Z-axis.

If bit 7 of 405 is set and bit 7 of 407 is not set, only the X and Y-axes must be brought to the reference point for interlock of NC start.

7.4.8 Spindle with ROD Encoder

N407, bit 0, gear range ratio:

(spindle actual value, 2-fold)

| Spindle actual value multiplied by | Bit 0 |
|------------------------------------|-------|
| 2 | 1 |
| 1 | 0 |

In order to achieve higher spindle speed, it is possible to gear the ROD encoder down (with a ratio of 2:1) to the spindle, in which case the spindle actual value must be multiplied by 2. The maximum allowed spindle speed can thereby be doubled (to max. 9999 min⁻¹).

Limit values for the ROD encoder (ROD 426): max. 100 kHz, corresponding to 6000 min⁻¹ (rpm).

N407, bit 1: (sign change for spindle actual value)

| Positive partial actual value is calculated | Bit 1 |
|---|-------|
| Negative | 1 |
| Positive | 0 |

The measured spindle actual value takes into account the sign change.

N407, bit 2: (pulse coder installed)

| Installed pulse coder | Bit 2 |
|-----------------------|-------|
| yes | 1 |
| no | 0 |

This bit activates the hardware monitor of the spindle encoder (alarm 224), and the display of the spindle actual value.

7.4.9 Speed in 0.1 rpm, N407 Bit 3

The spindle speed is programmed 10-fold.

Example: for 99 rpm = S990 programmed.

The speed is displayed correctly (99 rpm).

The maximum speed when this bit is set, is 999.9 rpm.

Only for 3T/M 3, starting with software edition 02.

7.4.10 Reference Point

(NC-start release without reference point)

N407, bit 7:

| Machine does not have a reference point | Bit 7 |
|---|-------|
| yes | 1 |
| no | 0 |

If bit 7 is not set, the reference points of all axes must be approached after the control is switched on, because otherwise the NC-start will be inhibited in the MDA and AUT operating modes (alarm 351). Also see section 11.4.7 .

7.4.11 Auxiliary Function Output

N408, bit 0 and 1:

(Auxiliary function output during sequence number search)

| Auxiliary function output during SNS | Bit | |
|---|-----|---|
| | 0 | 1 |
| None | 0 | 0 |
| After NC-start | 0 | 1 |
| During SNS | 1 | 0 |

According to machine manufacturers, the output of the auxiliary function must be determined during sequence number search; also see the interface description for system 3, section 3.5 .

N408, bit 2:

(Auxiliary function output prior to travel)

| Auxiliary function output | Bit 2 |
|---------------------------|-------|
| Before movement | 1 |
| During the movement | 0 |

According to the machine manufacturers, it must be determined whether the auxiliary function output occurs before or during the travel of the axis.

7.4.12 Evaluation of the Programed Data with S-analog

N408, bit 3:

(Short-circuit for S-input data)

| Evaluation of programed speed and direction | Bit 3 |
|--|-------|
| Internally in NC | 1 |
| Through interface control | 0 |

The two possibilities are explained in detail in the interface description system 3, section 3.9.1 .

When bit 3 = 1, the NC interprets the programmed spindle speed, respectively surface velocity and M03, M04, M05 internally, and outputs it as analogue spindle speed command value. Overwriting via the interface for S and direction is possible through the "External Data Input". The overwritten values are active until "RESET" or end of the program; during this interval, the programmed data are suppressed.

The programmed S-values are always processed by the PC, even when bit 3 = 1, if the FB21 and FB22 function blocks of the PC are active; this is described in the following paragraph for bit 3 = 0.

When bit 3 = 0, the interface control will decode the BCD data outputted by the NC, and will return them via the "External Data Input" to the NC. The interface control can thereby modify the data for special functions such as gear change and chip braking. The NC internal processing of programmed data for the spindle is inactive.

7.4.13 Position Control Feed-back and Input System, Metric/Inch

N408, bit 4 (position control system), bit 6 (reset state of input system)
N408 bit 5 must always be set to 0.

These machine data bits become active only after PORESET.

Option B41 is required for cases where bits 4 and 6 are not equal.

N408, bit 4:

(Position control system installed on the machine)

| Position control system | Bit 4 | Units |
|-------------------------|-------|--------------------------------|
| Inch | 1 | $\frac{1}{2} \cdot 10^{-4}$ in |
| Metric | 0 | $\frac{1}{2} \cdot 10^{-3}$ mm |

N408, bit 6:

(Reset state of the input system)

| Reset state of input system | Bit 6 | Units |
|-----------------------------|-------|----------------------|
| Inch $\hat{=}$ G70 | 1 | $1 \cdot 10^{-4}$ in |
| Metric $\hat{=}$ G71 | 0 | $1 \cdot 10^{-3}$ mm |

For operation and programming, the relationship of different machine data on certain units must be taken into consideration.

The following machine data are dependent on bit 4 (position control system):

| | | |
|------------|------------|------------|
| N100...103 | N170...173 | N220...223 |
| N110...113 | N180...183 | N352 |
| N150...153 | N190...193 | N385 |
| N160...163 | N210...213 | |

The following display values depend on bit 4 :

800 - 801
810 - 813
830 - 833
840 - 844

The following machine data depend on bit 4 (input system) :

| | | |
|------------|------|------------|
| N120...123 | N350 | N356 |
| N130...133 | N351 | N371...375 |
| N200...203 | N355 | |

Also dependent on bit 6 (input system), but not on programmed G70/G71 :

Actual value display,
Zero offset (1st.through 4th. and external),
Surface velocity G96,
Feed rate G94,95 ,
Tool offset,
Incrementing - increments,

The programmed zero offset G59 depends on G70 or G71; the content of the setting datum is processed according to the input system.

7.4.14 No Deceleration at Limit Switch

(Quick-stop at the software limit switch)

N408, bit 7:

| Digital velocity command value | Bit 7 |
|--------------------------------|-------|
| 0 | 1 |
| Deceleration ramp | 0 |

(for effects, see the next page)

Bit 7=1 (without deceleration)

Bit 7=0 (with deceleration)

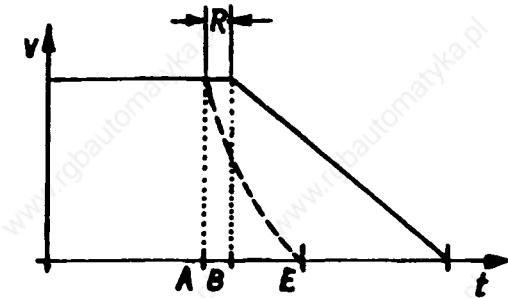
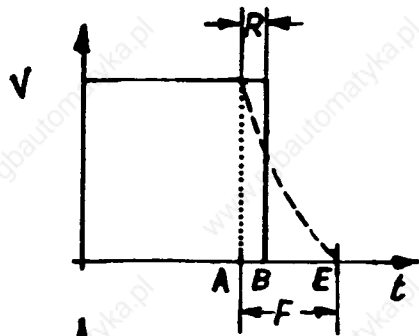
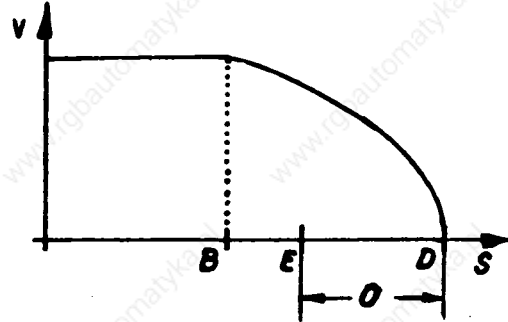
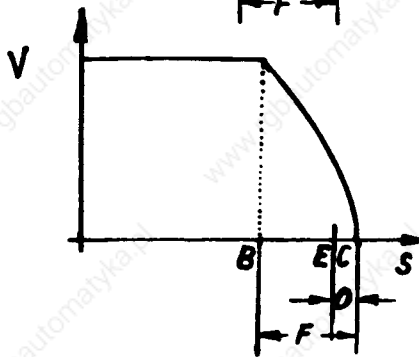
Digital
velocity
command
valueActual
velocity

- A Actual value counter content = position value of software limit switch
 B Start-point of deceleration
 C Stop-point without deceleration
 D Stop-point with deceleration
 E Position value of the software limit switch
 (N160...163 and N170...173)
 F Following error (dependent on K_v and v)
 R Computer timing (actual value up-date time)
 O Ovrerrun

If the actual value counter shows the same value as the position value of the software limit switch (point A), due to the computer timing R (actual value up-date time), at low deceleration at point B :

- When the bit is set, the digital velocity command value \emptyset is outputted, and only the following error A is eliminated. The overrun O ($E - C$) results from the computer timing R ; it can be practically \emptyset , or it can be negligibly small (see the note for the worst case value, on next page).
- When the bit is not set, the digital velocity command value is brought to \emptyset according to a ramp function. The overrun ($E - D$) results from the computer timing R and from the value for acceleration and deceleration set under N120...123.

The overrun portion caused by the computer timing is negligeably small, especially relative to the total deceleration distance.

Note:

The distance that can be traveled between actual value scannings is negligeably small; in the worst case, the maximum distance can be at 10 ms up-date time, and axis velocities from 15 m/min:2.5 mm, and from 1 m/min: 167 μ m.

7.4.15 Tool Length Compensation for Non-programed Axis (Only for 3T)

N409, bit 0 (only for 3T) :

Length compensation can be executed even for axes which are not programed.

| Length compensation for non-programed axis | Bit 0 |
|--|-------|
| yes | 1 |
| no | 0 |

If the bit is set, then during the selection, cancellation, or offset number changes, even if one axis is not programed, the tool length compensation will be executed for it as well (see the programing instructions for 3T, section 4.2.1).

7.4.17 Diameter Programing (only for 3T)

N409, bit 2:

(Diameter programing of X-axis with G90)

| Distance X programed in: | Bit 2 |
|--------------------------|-------|
| Diameter | 1 |
| Radius | 0 |

The bit should be set according to the end-user's specifications.

7.4.18 PC Present

N409, bit 3:

The bit must be set if an integrated PC is present. If this bit is set, N409 bit 7 must also be set simultaneously.

7.4.19 Handwheel Present

N409, bit 4:

The bit must be set if a handwheel is present.

7.4.20 Feed Rate not on the Contour

N409, bit 5:

For radii, if this bit is set, the programed feed rate is maintained in respect to the tool nose or cutter radius (and not in respect to the part contour, in order to prevent inadmissible feed rate changes when the radii are too small). This may be used on lathes, where small radii are often programed, and where the cutter radius is relatively large.

7.4.21 Option 2nd. Input/Output Board

N409, bit 6:

When a second I/O board is present, this bit must be set. If bit 6 is not set, the S-values will be outputted in two sequences (10^3 and 10^2 , then 10^1 and 10^0).

This bit ought to be set only for version 1.

7.4.22 NC - PC Interface Activation

N409, bit 7:

This machine datum activates the interface. If the bit is set, interface signals can be transferred. Attention should be given to the fact that an interface be present, and that machine datum N409 bit 3 be properly set.

The operating modes are activated with the mode selector switch only if this bit is set. This is a prerequisite for the down-loading of the machine data tape.

7.4.23 Key Switch Active for Some Operating Modes

N410, bit 0 - 7:

(according to customer's request)

The appropriate function is interlocked with the key switch when the corresponding bit is set. The following functions can be interlocked:

| Bit # | Function | System 3 Operating Instructions (section with explanations) |
|-------|----------------------------|---|
| 0 | Superimposing | 7 |
| 1 | Sequence number search | 7.2 |
| 2 | Dry run | 1.7 |
| 3 | Part program editing *) | 7.4 |
| 4 | T0-data, incremental input | 8 |
| 5 | T0-data, absolute input | 8 |
| 6 | Z0-data (Z0, SE) | 8, & 9.3 |
| 7 | DATA-start in MDA | 4.2 & 4.3 |

*) and cancel

7.4.24 I/O Interface V24 (RS 232 C)

N411 and N412, bits 0 through 7:

(Baud rate and coding of the input and output device)

This specifies the designation of the input and output devices.

N411 indicates the input, and N412 indicates the output of device connected to board 03 100, connector X103. The interface can be operated as V24 (RS 232 C) or as 20 mA full duplex interface; N416 bit 0 must thereby always be set .

See section 2 for the meaning of the 8 bits.

7.4.25 EIA code for @ Sign (A)

N413, bits 0 through 7:

The EIA code contains no @ sign, it therefore becomes necessary to select a function key to represent the @ key. This tape bit pattern must be set here.

7.4.25 Name of Main Axis Associated with the 4th. Axis (B)

| Bit | | Name |
|-----|---|------|
| 1 | 0 | |
| 0 | 0 | X |
| 0 | 1 | Y |
| 1 | 0 | Z |

7.4.25 DC Control Character Without Parity (C)

Versions 0 and 2, starting with software edition 06

Version 3 , starting with software edition 02

If the bit is set to 0, the DC signals are sent with parity.

7.4.26 Option Bits

The following bits must be set for the 3T :

| | Bit | | | | | | | |
|------|-----|---|---|---|---|---|---|---|
| | 7 | 6 | 5 | 4 | 3 | 2 | 1 | 0 |
| N415 | 1 | X | 1 | X | 1 | X | 1 | X |
| N416 | | | X | X | X | 1 | 1 | 1 |

The following bits must be set for the 3M :

| | Bit | | | | | | | |
|------|-----|---|---|---|---|---|---|---|
| | 7 | 6 | 5 | 4 | 3 | 2 | 1 | 0 |
| N415 | 1 | X | X | X | 1 | X | X | X |
| N416 | | | X | X | X | 1 | 1 | 1 |

X Individual bits are set according to start-up instructions and data sheet of the control (check list in section 1.1)

N415, bit 1: Thread and feed per revolution (only 3T) contained in the basic control. Bit 1 must be set to "1". A spindle encoder must, of course, be present.

N415, bit 3: Teach-in, playback and MDA (see operating instructions, section 4) are contained in the basic control. Bit 3 must be set to "1".

N415, bit 5: Analogue spindle speed (only for 3T). For the 3T, bit 5 must be set to "1", and bit 1 of 415 must also thereby be set to "1".

N415, bit 7: Tool nose radius compensation for 3T, respectively cutter radius compensation for 3M, is contained in the basic control. Bit 7 must be set to "1".

N416, bit 0: V24 interface (RS 232 C) on X103 connector of CPU 03100 for the devices described in section (contained in the basic control).

N416, bit 1: Cycles for turning, respectively drilling operations, according to the programming instructions, section 7. The cycle programs are stored in the RAM memory of the control (basic).

N416, bit 2: Alarm texts additional to the coded displays are contained in the basic control version.

7.4.27 Actual Values of X-axis at 3T, Displayed in Diameter

N416, bit 6:

When the bit is set, the actual values for 3T are displayed in diameter.

N409 bit 2 must, however, be set.

Versions 0 and 2, starting with software edition 06

Version 3, starting with software edition 02.

7.4.28 Block End with Carriage Return and Line Feed

N416, bit 7:

The program output is normally with LF, CR, CR.

An output of CR LF is necessary for DNC operation.

CR LF is the output if the bit is set.

7.4.29 14 BIT DAC (Digital/Analogue Converter) : Very important !

N417, bit 0:

The bit may not be set when position control board 03320-03323 is used.

$$1 \text{ VELO} = \frac{10 \text{ V}}{2048}$$

The bit must be set when position control boards 03325 and 03350 are used.

$$1 \text{ VELO} = \frac{10 \text{ V}}{8192}$$

The following machine data must be checked in conjunction with this :

Nr. 140-143, nr. 354/nr. 230-233

Versions 0 and 2, starting with software edition 06

Version 3, starting with software edition 02

7.4.30 Wear Input in Diameter

N417, bit 2:

Only 3T and X-axis.

The incremental input value is divided by 2 before it is entered into the tool offset memory.

Versions 0 and 2, starting with software edition 06

Version 3, starting with software edition 02

7.4.31 Spindle Override Active in Threading

N417, bit 3:

If the bit is set, the spindle override will be active even if G33 or G63 is programmed.

Versions 0 and 2 starting with software edition 06

Version 3, starting with software edition 02

7.4.32 Deceleration to the Velocity of the Next Block

N417, bit 4:

The velocity is changed to that programmed for the next block, according to the deceleration ramp at contouring (G64).

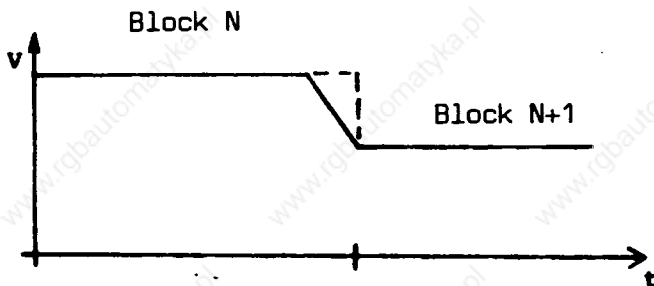

Bit = 0 - - - - -

Bit = 1 _____

Wood work applications

Versions 0 and 2, starting with software edition 06

Version 3, starting with software edition 02

7.4.33 Test Bits

N418, bits 0 through 7:

Since some bits are used for test purposes, these machine data bits must be set to 0.

7.4.34 Display Bits

N419, bits 0 through 7:

If the timing sequence of the NC software is interrupted (e.g. the NC cannot access because of the access of the PG 670), these bits are set to "1".

The bits can be reset only through PORESET.

8 Interface Test

Content

- 8.1 Signal Display
- 8.2 Pin-out of Input and Output Connectors
- 8.3 Code Tables
- 8.4 Data of the Signal Transmission (External Data Input)
- 8.5 Coupling of the Machine Control Panel to the PC
- 8.6 Possibility of Connecting Additional Operating Functions
- 8.7 Interface Adapter Connector and Adapter, Position Control Diagnostic Connector

Note:

For measuring and separation adapters, see section 9.13 .

8.1 Signal Display

The interface test is used during malfunctions, to find out whether the cause lies inside or outside the SINUMERIC, and whether the VDI signals are properly connected.

Important: The output stages are not checked for the output signals of the digital input/output board 03 400. When in doubt, the corresponding connector pin should be checked with a measuring device or a diagnostic program.

Interface Test - Procedure

Select TEST



TEST

Operating mode selector switch, except in DO/DI, with the mode key  to page test  .

The input and output signals are selected with the page key



...





to

Nr. 7 - Nr. 11

The signals are produced in the same signal form in which they can be found in the integrated PC interface. The name designation for the signals is adapted to the PC interface.

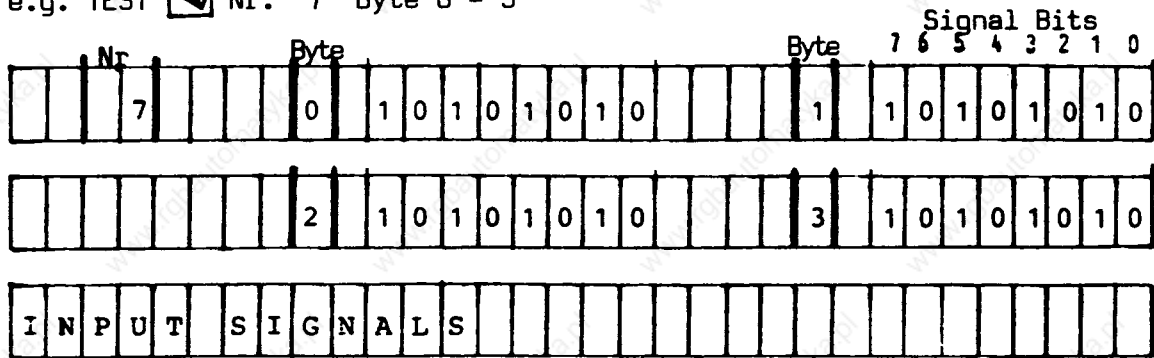
Page,

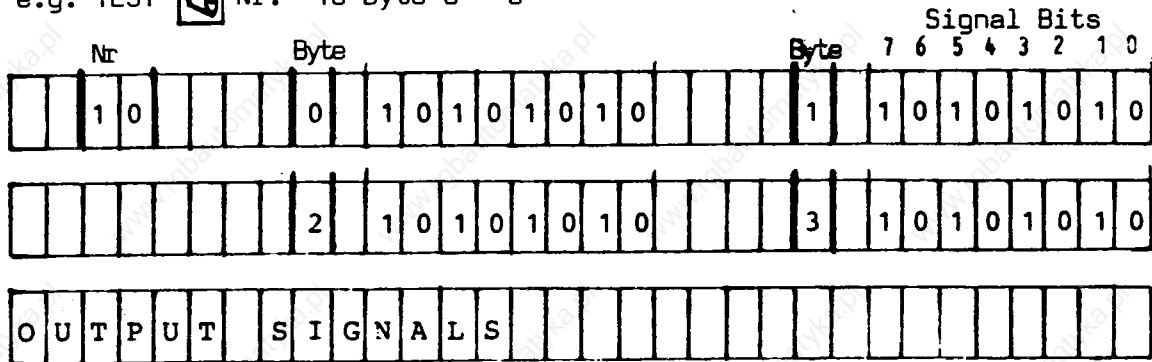
e.g. TEST  Nr. 7 Byte 0 - 3e.g. TEST  Nr. 10 Byte 0 - 3Note :

- Outputs cannot be set with the interface test; this can only be done with the engineering panel (operator panel and test board).
- The operating mode selector switch can only be tested for each individual position, because the mode (display range) is changed with each switching.
- See section 2.8 for lists of the interface signals

8.2 Pin Layout of the Input and Output Connectors

The connection is made separately for inputs and outputs, on a 50 pole subminiature connector.

Cable: SINUMERIK standard cable 6FC9 340-2W.

Input connector X402, IN

| Byte (consecutive byte nrs.in reference to board) | Connector Pin | | | | | | | |
|---|---------------|----|----|----|----|----|----|----|
| | 7 | 6 | 5 | 4 | 3 | 2 | 1 | 0 |
| 0 | 8 | 7 | 6 | 5 | 4 | 3 | 2 | 1 |
| 1 | 16 | 15 | 14 | 13 | 12 | 11 | 10 | 9 |
| 2 | 25 | 24 | 23 | 22 | 21 | 20 | 19 | 18 |
| 3 | 33 | 32 | 31 | 30 | 29 | 28 | 27 | 26 |
| 4 | 41 | 40 | 39 | 38 | 37 | 36 | 35 | 34 |
| 5 | 49 | 48 | 47 | 46 | 45 | 44 | 43 | 42 |

Plug IN



Pin nr.
(looking at the
front plate
of the board)

Output connector X403, out

| Byte (consec.byte nrs.in refe- rence to the board) | Connector Pin | | | | | | | |
|--|---------------|----|----|----|------------------|----|----|----|
| | 7 | 6 | 5 | 4 | 3 | 2 | 1 | 0 |
| 0 | 16 | 15 | 14 | 13 | 12 | 11 | 10 | 9 |
| 1 | 25 | 24 | 23 | 22 | 21 | 20 | 19 | 18 |
| 2 | 33 | 32 | 31 | 30 | 29 | 28 | 27 | 26 |
| P24 (+24V) | | | 1 | 2 | 3 from interface | | | |
| Mext (0V) | | | 34 | 35 | from interface | | | |

Plug OUT



Pin nr.
(looking at the
front plate
of the board)

8.3 Code Tables8.3.1 Operating Mode Selector Switch (Gray-coded) S15 (acc. to diagram 03720)

TEST Nr. 7 Byte 0

Code Table

| Position | Conne- ction | Symbol | Code | | | | Signal Name | |
|----------|-----------------|--------|------|---|---|---|----------------|-------------|
| | | | D | C | B | A | | |
| 1 | 1 | | 0 | 0 | 0 | 1 | DO | |
| 2 | 3 | } | 0 | 0 | 1 | 1 | DI | |
| 3 → *) | 5 | | 0 | 0 | 1 | 0 | MDA | |
| 4 | 7 | } | 1 | 0 | 1 | 0 | JOG | |
| 5 → +) | 9 | | 1 | 0 | 1 | 1 | } INC | |
| 6 | 11 | | 1 | 0 | 0 | 1 | | |
| 7 | 13 | 1 | 1 | 0 | 0 | 1 | | |
| 8 | 15 | 10 | 1 | 1 | 0 | 0 | | |
| 9 | 17 | | 1 | 1 | 0 | 1 | } MDI-PP | |
| 10 | 19 | 100 | 0 | 1 | 0 | 0 | | } MDI-SE-TE |
| 11 | 21 | 1000 | 0 | 1 | 1 | 0 | | |
| 12 → *) | 23 | | 0 | 1 | 1 | 0 | AUT | |
| 13 | 25 | } | 0 | 1 | 1 | 0 | } REF | |
| 14 | 27 | | 1 | 1 | 1 | 0 | | |
| 15 → +) | 29 | } | | | | | | |
| 16 | 31 | | | | | | | |

Software generated clear-functions (at switch-over):

*) : RESET (Clears all unbuffered controls and memories, except for block nr., actual value, and machine data memories, like at program end and reset)

+) : CLPROAC (Clears "Program active" and "Feed hold")

Also, when switching over from MDA to AUT and vice versa : RESET -to prevent interferences in the automatic program with TEACH-IN and PLAYBACK. (RESET occurs only within program mode.)

8.3.2 Axis Selector Switch S18 (only 3M, acc. to diagram 03720)

TEST nr. 7, byte 2

Code Table

| Position | Connection | Symbol | Code | |
|----------|------------|--------|------|---|
| | | | B | A |
| 1 | 1 | X | 0 | 0 |
| 2 | 3 | Y | 0 | 1 |
| 3 | 5 | Z | 1 | 0 |
| 4 | 7 | 4 | 1 | 1 |

8.3.3 Feed Override Switch (Gray coded) S17 (acc. to diagram 03720)

TEST nr. 7, byte 0

Code Table

| Position | Connection | Symbol F  % | Code | | | |
|----------|------------|--|------|---|---|---|
| | | | D | C | B | A |
| 1 | 1 | 0 | 0 | 0 | 0 | 0 |
| 2 | 3 | 1 | 0 | 0 | 0 | 1 |
| 3 | 5 | 2 | 0 | 0 | 1 | 1 |
| 4 | 7 | 4 | 0 | 0 | 1 | 0 |
| 5 | 9 | 6 | 0 | 1 | 1 | 0 |
| 6 | 11 | 8 | 0 | 1 | 1 | 1 |
| 7 | 13 | 10 | 0 | 1 | 0 | 1 |
| 8 | 15 | 20 | 0 | 1 | 0 | 0 |
| 9 | 17 | 40 | 1 | 1 | 0 | 0 |
| 10 | 19 | 60 | 1 | 1 | 0 | 1 |
| 11 | 21 | 70 | 1 | 1 | 1 | 1 |
| 12 | 23 | 80 | 1 | 1 | 1 | 0 |
| 13 | 25 | 90 | 1 | 0 | 1 | 0 |
| 14 | 27 | 100 | 1 | 0 | 1 | 1 |
| 15 | 29 | 110 | 1 | 0 | 0 | 1 |
| 16 | 31 | 120 | 1 | 0 | 0 | 0 |

8.3.4 Spindle Override Switch (Gray coded) S16 (acc. to diagram 03720)

TEST nr.7, byte 1

Code Table

| Position | Connection | Symbol S  % | Code | | |
|----------|------------|---|------|---|---|
| | | | C | B | A |
| 1 | 1 | 50 | 1 | 1 | 1 |
| 2 | 3 | 60 | 1 | 1 | 0 |
| 3 | 5 | 70 | 0 | 1 | 0 |
| 4 | 7 | 80 | 0 | 1 | 1 |
| 5 | 9 | 90 | 0 | 0 | 1 |
| 6 | 11 | 100 | 0 | 0 | 0 |
| 7 | 13 | 110 | 1 | 0 | 0 |
| 8 | 15 | 120 | 1 | 0 | 1 |

8.3.5 Gear ranges (Coded Input Signal)

TEST nr. 8, byte 4

Code Table

| Gear | C | B | A |
|--------|---|---|---|
| 1 | 0 | 0 | 0 |
| 2 | 0 | 0 | 1 |
| 3 | 0 | 1 | 0 |
| 4 | 0 | 1 | 1 |
| 5 | 1 | 0 | 0 |
| 6 | 1 | 0 | 1 |
| 7 | 1 | 1 | 0 |
| 8 | 1 | 1 | 1 |
| Bit-Nr | 7 | 6 | 5 |

| Bit Datum | 3T Code Signal | | 3M Code Signal | | Data word - BCD - | | | | |
|---|------------------------|-----------|------------------------|-----------|---------------------------------------|---------------------------------------|---------------------------------------|---------------------------------------|---|
| | 4 3 2 1 0 E D C B A | | 4 3 2 1 0 E D C B A | | 10 ³ 7 6 5 4 Q P O N | 10 ² 3 2 1 0 M L K I | 10 ¹ 7 6 5 4 H G F E | 10 ⁰ 3 2 1 0 D C B A | |
| Function | Axis | | Axis | | 14 - | Maximum numerical value per decade | | | |
| Incremental tool offset (additive calculation, no memory of its own) | X | 0 0 0 0 1 | X | 0 0 0 0 1 | + - | 7 | 9 | 9 | 9 |
| | Z | 0 0 0 1 0 | Y | 0 0 0 1 0 | + - | 7 | 9 | 9 | 9 |
| | - | - | Z | 0 0 0 1 1 | + - | 7 | 9 | 9 | 9 |
| | - | - | 4. | 0 0 1 0 0 | + - | 7 | 9 | 9 | 9 |
| Incremental zero offset (additive calculation, absolute in its own memory) | X | 0 1 0 0 1 | X | 0 1 0 0 1 | + - | 7 | 9 | 9 | 9 |
| | Z | 0 1 0 1 0 | Y | 0 1 0 1 0 | + - | 7 | 9 | 9 | 9 |
| | - | - | Z | 0 1 0 1 1 | + - | 7 | 9 | 9 | 9 |
| | - | - | 4. | 0 1 1 0 0 | + - | 7 | 9 | 9 | 9 |
| S U/min; m/min | | 1 1 0 0 0 | | 1 1 0 0 0 | | 9 | 9 | 9 | |
| F mm/min | | 1 1 0 0 1 | | 1 1 0 0 1 | | 9 | 9 | 9 | |
| % Program nr. | | 1 1 0 1 0 | | 1 1 0 1 0 | | 9 | 9 | 9 | |
| PC alarm indication* | | 1 0 0 0 0 | | 1 0 0 0 0 | 0 | 7 BIT ASC II-Code | 0 | 7 BIT ASC II-Code | |

Maximum value for tool offset and zero offset:

$$\pm 7.999 \text{ mm} ; \pm 0.7999''$$

See interface description section 3.10

* Only for version 3, starting with software edition 02
FB22 must have edition 02

8.5 Coupling of the Machine Control Panel 3M to the PC

| PC Inputs Byte-Adr. | PC Data bit | | | | | | | | |
|---------------------------|---|---|--------------------------------|-----------------------|--|--|----------------------|------------|------------|
| | 7 | 6 | 5 | 4 | 3 | 2 | 1 | 0 | |
| | Operating Mode Selector Switch D 8 C 7 B 6 A 5 | | | | Feed/Rapid Traverse Override Switch D 4 C 3 B 2 A 1 | | | | |
| | Key switch 46 | Dry run 15 | Block delete 14 | Single block 13 | SNS 12 | Spindle override switch C 11 B 10 A 9 | | | |
| | Rapid tra- verse over- ride 25 active | Rapid tr. superimpo- sition 24 | Directional keys *) 23 22 | | Axis-selector swt. *) Code B 21 A 20 | | X 19 18 | | |
| | Spindle OFF 33 | Spindle ON 32 | Feed HOLD 31 | Feed START 30 | X 29 | | Cycle START 28 | free 27 | free 26 |
| | free 41 | free 40 | free 39 | free 38 | free 37 | free 36 | free 35 | free 34 | |
| | free 49 | free 48 | free 47 | free 46 | free 45 | free 44 | free 43 | free 42 | |

*) For 3T: for the directional keys X+, X-, Z+, X-, and the handwheel switch X, see the interface description, section 4

1... 49 pin numbers of the 50-pole input connector

8.6 Machine Control Panel Connector Board with Option for Connection of Additional Operating Functions

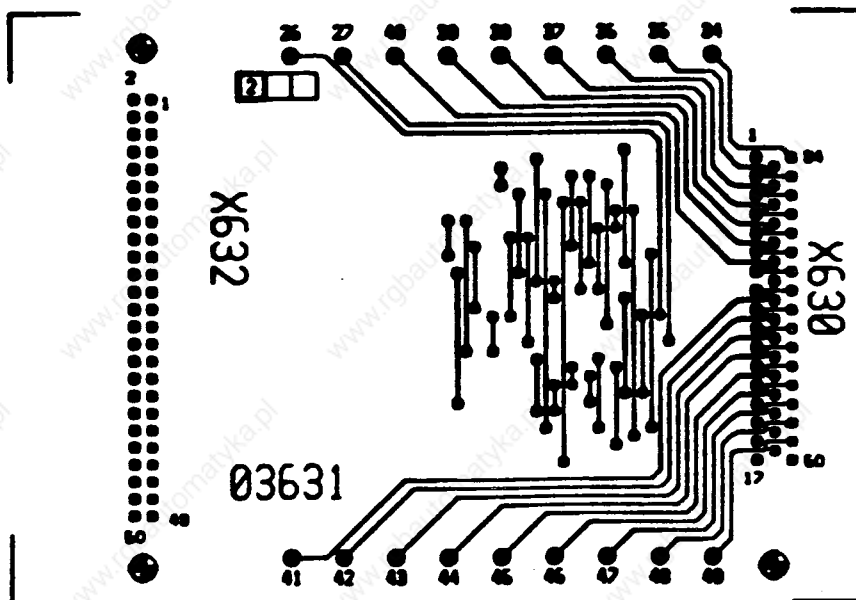

26, 27 and 34 through 49 are free

Soldering points for the connection of additional functions of the machine control panel.

8.7 Interface Adapter-connector and Adapter, Position Control Diagnostic Connector

8.7.1 Interface Adapter-connector

The following separation adapters are available for test purposes for the wires connected to the boards:

| | |
|----------|----------------------|
| 15-pole: | Ident-Nr. 400 91 337 |
| 25-pole: | Ident-Nr. 400 91 350 |
| 50-pole: | Ident-Nr. 400 91 374 |

8.7.2 Interface Adapter

Interface adapter for output signals with switch, test jack, and switchable LED per each output; in housing 220 x 130 x 50 mm³, with 50-pole connector (male), and cable 0.4 mm long with 50-pole connector (female) for connection in between an output line of 03 400.

Device designation : 6FC9 330-0BA

Order number: Ident-Nr. 706 88 203

8.7.3 Position Control Diagnostic Connector

This connector (designated MKDS in the System 8 diagnostic case, jumper connector for the actual value) is used to test the control without connected position encoder, respectively in the absence of an axis. One connector is required for each axis.

Order number : Ident-Nr. 400 91 279

This jumper connector can be produced in the following manner:

Sub-miniature connector, 15-pole, female (complete), order-nr. 6FC9 341-1EC.

Wiring:

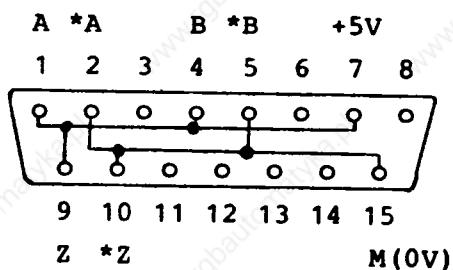

as seen from the wiring
(back) side

Characterizes: System 3 & 8 MKDS

The connector and adapter can be ordered from :

SIEMENS AG, ZN Nürnberg-Werkstatt, Würzburger Strasse 121, 8510 Fürth

9. Board Overview and Strappings

9.1 Generalities

9.2 CPU board 03100

9.3 EPROM Memory 03201/03202

9.4 RAM Memory 03210

9.5 Test Board 03220

9.6 Test Board 03221

9.7 RAM Memory 03260

9.8 Position Control (Actual Value) 03315

9.9 Position Control (Actual Value) 03315

9.10 Position Control (Command Value) 03320

9.11 Position Control (Command Value) 03320/03323

9.12 Position Control 03325

9.13 Position Control 03340

9.14 Position Control 03350

9.15 Integrated EXE 03390/03395

9.16 I/O Board 03400

9.17 Input Board 03410

9.18 Output Board 03421

9.19 I/O Board 03450

9.20 Output Board 03460

9.21 Power Supply 03501/03502

9.22 Power Supply 03410

9.23 Operator Panel 03700

9.24 Operator Panel 03710

9.25 Machine Control Panel 03720

9.26 Operator Panel 03770

9.27 Operator Panel 03780

9.28 Couple Board 03800

9.29 Video Interface 03810

9.30 Video Interface 03811

9.31 List of Strappings of Input/Output Boards, According to the PC Program.

9.1 Generalities

Strappings do not have to be changed during start-up, except for the addressing of I/O boards according to the user's program. When spare parts are delivered, it must be checked that the spare board strappings coincide with the "fixed strappings", according to the service manual. The variable strappings must coincide with the exchanged board according to the PC program.

The strappings are divided into the following categories :

- Fixed strappings
May not be changed
- Strappings according to the PC program
The I/O boards must be strapped by byte addresses, according to the PC user's program.
- Variable strappings,
which can be :

| | |
|--|--|
| Standard strappings (the control is shipped with these) | Special strappings (standard strappings modified at start-up) |
|--|--|

For strappings of the 6ES5 boards, see section 10.

For measurements on the boards or on the NC bus connector, it is strongly recommended that adapter 548 187 9001.00AS (ES902-Adapter 96-pole) be used; you should thereby be careful not to drop the board. (Bolt with thread M4)

Adapter Ident-nr. 706 77 558.

The following separation adapters are available for the testing of the wires connected to the boards :

15-pole: Ident-nr. 400 91 337
 25-pole: Ident-nr. 400 91 350
 50-pole: Ident-nr. 400 91 374

The adapters are available from:

Siemens AG, ZN Nürnberg Shop,
 Würzburger Strasse 121, 8510 Fürth
 also see section 8.7

Note: Remove the strapping sockets perpendicular to the board, in order to avoid bending the pins; insert with care. The pin sequence of the strapping socket as seen from the soldering side (note the marker notch):

9.2 CPU Board 03100

9.2.1 Fixed Strappings

| Type | Designation | Signal | Closed/Open | Remarks |
|----------------|-------------|--------|-------------|--------------------|
| Single jumper | R-S | RDY | closed | |
| " | AN-AM | Wait 1 | " | |
| " | AP-AQ | Wait 4 | " | for operator panel |
| " | M-N | - | open | |
| " | Q-P | - | " | |
| " | AA-AB | Wait 3 | " | |
| " | AC-AD | Wait 3 | " | |
| " | AE-AF | Wait 2 | " | |
| " | AG-AH | Wait 2 | " | |
| " | AK-AL | Wait 1 | " | |
| " | AR-AS | Wait 4 | " | |
| " | AT-AU | Wait 0 | " | |
| " | AV-AW | Wait 0 | " | |
| Soldering pins | AV-AW | Wait 0 | " | |

9.2.2 Variable Strappings

| Type | Designation | Signal | Standard NC active | Special NC passive |
|----------------|-------------|--------|-----------------------|-----------------------|
| Soldering pins | C-D | M | closed | open |
| " | E-F | + 12 V | " | " |
| " | G-H | + 12 V | " | " |
| " | K-L | M | " | " |
| " | H-K | TTY 3 | open | closed |
| " | C-F | TTY 1 | " | " |

9.2.3 Test Socket P1 (factory test for the board)

9.2.4 Switches on the CPU

S1: Data safety switch (toggle switch on front plate)

Reset state: lower position (no machine data input in inactive state)

S3: Test board switch (push-pull switch on board)

Reset state: upper position (test board/engineering panel routine inactive)

9.3 EPROM Memory 03201

Fixed Strappings

| Type | Designation | Signal | Closed/Open | Remarks |
|---------------|-------------|--------|-------------|---------|
| Single jumper | Wait 2 | Wait 2 | closed | |
| " | Wait 0 | Wait 0 | open | |
| " | Wait 1 | Wait 1 | " | |
| " | Wait 3 | Wait 3 | " | |
| " | Wait 4 | Wait 4 | " | |

Remark: There is no designation for the soldering pins on board 03200

Arrangement:

fixed strappings

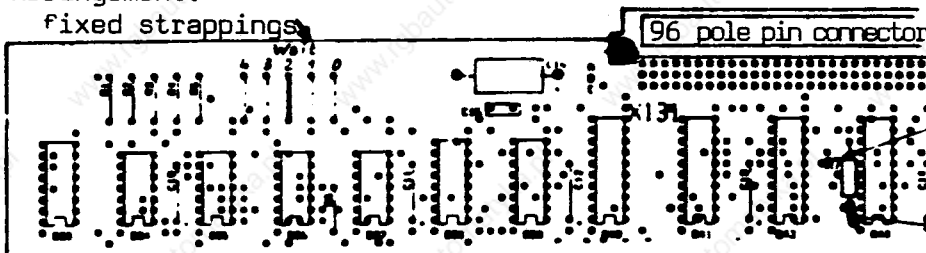

EPROM Memory 03202

Replaces type 03201

Fixed strappings:

| Type | Designation | Signal | Closed/Open | Remarks |
|---|-------------|--------|-------------|---------|
| Strapping socket X1  | 1-8 | | closed | Adr. 17 |
| | 2-7 | | " | Adr. 18 |
| | 3-6 | | " | Adr. 19 |
| | 4-5 | | open | free |
| Single jumper | W1 | Wait 1 | closed | |
| " | W0 | Wait 0 | open | |
| " | W2 | Wait 2 | " | |
| " | W3 | Wait 3 | " | |
| " | W4 | Wait 4 | " | |

9.4 RAM Memory 03210

Fixed Strappings:

| Type | Designation | Signals | Closed/Open | Remarks |
|---------------|-------------|------------|-------------|---------|
| Single jumper | B1 | RVCC RAM 0 | closed | |
| " | B0 | + 5 V | open | |
| " | 2W | Wait 2 | closed | |

9.5 Test Board 03220

Fixed Strappings:

| Type | Designation | Signals | Closed/Open | Remarks |
|---------------|----------------|-------------|-------------|---------|
| Single jumper | W3 | Wait 2 | closed | |
| " | W1, W2, W4, W5 | W0, 1, 3, 4 | open | |

9.6 Test Board 03221

Replaces type 03220

Fixed Strappings:

| Type | Designation | Signal | Closed/Open | Remarks |
|---------------|-------------|--------|-------------|---------|
| Single jumper | S16 | | open | Adr. 16 |
| " | S17 | | " | Adr. 17 |
| " | S18 | | closed | Adr. 18 |
| " | S19 | | " | Adr. 19 |
| Single jumper | W3 | | closed | Wait 2 |
| " | W1 | | open | Wait 0 |
| " | W2 | | " | Wait 1 |
| " | W4 | | " | Wait 3 |
| " | W5 | | " | Wait 4 |

9.7 RAM Memory 03260

Replaces type 03210

Fixed strappings:

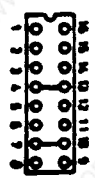
| Type | Designation | Signals | Closed/Open | Remarks |
|---|-------------|---------|-------------|---------|
| Strapping socket X1  | 1-16 | | Open | Adr. 16 |
| | 2-15 | | " | Adr. 17 |
| | 3-14 | | " | Adr. 18 |
| | 4-13 | | closed | Adr. 19 |
| | 5-12 | W3 | open | Wait 3 |
| | 6-11 | W2 | " | Wait 2 |
| | 7-10 | W1 | closed | Wait 1 |
| | 8-9 | W0 | open | Wait 0 |
| Single jumper | W4 | W4 | open | Wait 4 |

9.8 Position Control Loop (Actual Value) 03310 /03311

Fixed Strappings:

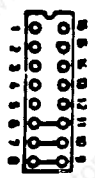

| Type | Designation | Signal | Closed/Open | Remarks |
|---|-------------|--------|-------------|---------|
| Strapping socket X5  | 1-16 | | open | Adr. 0 |
| | 2-15 | | " | Adr. 10 |
| | 3-14 | | " | Adr. 6 |
| | 4-13 | | " | Adr. 9 |
| | 5-12 | | " | Adr. 7 |
| | 6-11 | | closed | Adr. 19 |
| | 7-10 | | " | Adr. 8 |
| | 8-9 | | open | Adr. 5 |
| Strapping socket X6  | 1-16 | | open | Adr. 18 |
| | 2-15 | | " | Adr. 11 |
| | 3-14 | | " | Adr. 17 |
| | 4-13 | | " | Adr. 12 |
| | 5-12 | | " | Adr. 16 |
| | 6-11 | | closed | Adr. 13 |
| | 7-11 | | " | Adr. 15 |
| | 8-9 | | " | Adr. 14 |
| Single jumper | P-R | SCLKSM | open | 5 MHz |

Fixed strappings

| Type | Designation | Signals | Closed/Open | Remarks |
|---------------|-------------|---------|-------------|---------|
| Single jumper | W0 | Wait 0 | open | |
| " | W1 | Wait 1 | closed | |
| " | W2 | Wait 2 | open | |
| Single jumper | C-D | | open | 3310 A |
| " | C-D | | closed | 3310 B |

Remark: If there are more than 3 position actual values, board 03310 B is sandwiched to board 03310 A. Both boards have the same strapping, except for pins C-D.

Variable strappings

| Type | Designation | Signals | Standard, Position act. val. diff. input | Special, Pos. act. val. asymmetrical inputs |
|---|-------------|---------|--|---|
| Strapping socket | 1-16 | *DMA | closed | open |
| X1 und X2 | 2-15 | *DMB | " | " |
| Standard St. | 3-14 | *DMZ | " | " |
|  | 4-13 | IDMA | " | closed |
| | 5-12 | IDMB | " | " |
| | 6-11 | DMA | open | " |
| | 7-10 | DMB | " | " |
| | 8-9 | DMC | " | " |
| Special St. (not used) | | | | |
|  | | | | |

9.9 Position Control Loop 03315

9.9.1 Fixed Strappings

| Type | Designation | Signal | Closed/Open | Remarks |
|---------------|-------------|------------------------------------|-------------|-----------|
| Single jumper | S3 | SFBG1 | open | Addresses |
| " | S4 | SFBG2 | " | " |
| Single jumper | WS1 | | open | |
| " | WS2 L-K | M _{ext} -M _{int} | " | |
| Single jumper | W1 | | open | Wait |
| " | W2 | | " | " |
| " | W3 | | closed * | " |
| " | W4 | | open | 2 |

* Connection W3 on the trace of the Pcb .

9.9.2 Fixed Strappings for EXE

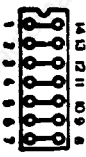
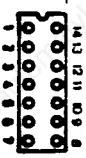
| Type | Designation | Signal | w/o Option integrated EXE | with Option integrated EXE |
|---|-------------|--------|---------------------------------|----------------------------------|
| Strapping socket | 1-14 | - | closed | open |
| X3 - X-Achse | 2-13 | *SDMB | " | " |
| X1 - Y-Achse | 3-12 | SMDB | " | " |
| X2 - Z-Achse | 4-11 | *SDMA | " | " |
| X4 - 4. Achse | 5-10 | SDMA | " | " |
| w/o Option | 6-9 | *SDMZ | " | " |
| | 7-8 | SMDZ | " | " |
|  | | | | |
| with Option | | | | |
|  | | | | |

9.9.3 Variable Setting for Probes

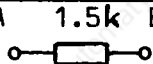
| Type | Designation | Signal | Standard | Remarks |
|----------------|-------------|--------|--|---|
| Soldering pins | A-B/R32 | | A 1.5k B  | For other settings, depending on probe output, see the section on interface |
| " | C - D/R33 | | open | |
| " | E - F | | open | |

9.10 Position Control (Command Value) 03320

Fixed Strappings

| Type | Designation | Signal | Closed/Open | Remarks |
|---------------|-------------|--------|-------------|---------|
| On trace | W1 | Wait 1 | Closed | |
| Single jumper | AA-BB | 5 MHz | Open | |

Variable Strappings

(X1)

Position coder actual value strapping socket ψ see 9.11.2

| Type | Designation | Signal | Standard strappings Signal, Velocity Control Ready from drive | Special strappings not monitored |
|----------------|-------------|------------------------|---|-------------------------------------|
| Soldering pins | W-X | Servo-Ready simulation | Open | Closed |



Test Points

| Type | Designation | Signal | Remarks |
|------|-------------|-------------|---------------------------|
| Pin | R,T,V,B,D | CVS 1...5 | Command values axis 1...5 |
| Pin | Q,S,U,A,E | (internal) | Enable axis 1...5 |
| Pin | L,M,P,F,G | *SEEN 1...5 | Control enable axis 1...5 |
| Pin | N | *NC Ready | NC-Ready simulation |

9.11 Position Control (Command Value) 03322/03323

- 1 Actual value input
- 5 Command value outputs
- 12 BIT-DAC $1\text{VELO} = \frac{10\text{ V}}{2048}$
- applicable in conjunction with PC board 03310

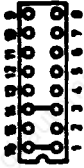
9.11.1 Fixed Strappings

| Type | Designation | Signal | Closed/Open | Remarks |
|--|-------------|--------|---------------|----------|
| Single jumper | AF-AE | 1 Wait | closed | |
| " | AD-AC | 0 Wait | open | |
| " | AH-AG | 2 Wait | " | |
| " | AA-BB | SCLK5M | " | 5 MHz |
| Strapping socket X2  | 1-16 | | closed | Addr. 19 |
| | 2-15 | | open | Addr. 10 |
| | 3-14 | | closed | Addr. 8 |
| | 4-13 | | open | Addr. 9 |
| | 5-12 | | " | Addr. 5 |
| | 6-11 | | " | Addr. 6 |
| | 7-10 | | " | Addr. 7 |
| | 8-9 | | " | Addr. 3 |
| Strapping socket X2  | 1-16 | | closed | Addr. 13 |
| | 2-15 | | open | Addr. 12 |
| | 3-14 | | closed | Addr. 15 |
| | 4-13 | | " | Addr. 14 |
| | 5-12 | | open | Addr. 17 |
| | 6-11 | | " | Addr. 16 |
| | 7-10 | | " | Addr. 18 |
| | 8-9 | | " | Addr. 11 |

9.11.2 Variable Strappings

| Type | Designation | Signal | Standard strapping Position Coder Actual value Differential Input | Special strapping: Position Coder Actual value w/o Inverting Input (Asymmetric Signals) |
|--|-------------|--------|---|---|
| Strapping socket X1 Standard strappings | 1-16 | *DMA | closed | open |
| | 2-15 | *DMB | " | " |
| | 3-14 | *DMZ | " | " |
| | 4-13 | IDMA | " | closed |
| | 5-12 | IDMB | " | " |
| | 6-11 | DMA | open | " |
| | 7-10 | DMB | " | " |
| | 8-9 | DMZ | " | " |
| Special strapping (not used) | | | | |

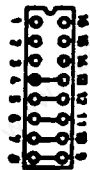

| Type | Designation | Signal | Standard Signal | Special Velocity Control Ready |
|----------------|-------------|------------------------|-----------------|--------------------------------|
| | | | from drive | not monitored |
| Soldering pins | P-N | Servo Ready Simulation | open | closed |

Test Points

| Type | Designation | Signal | Remarks |
|------|-------------|-------------|---------------------------|
| Pin | T,W,Z,D,G | CVS 1...5 | Command values axis 1...5 |
| " | S,V,Y,C,F | (internal) | Enable axis 1...5 |
| " | Q,R,U,E,L | *SEEN 1...5 | Control enable axis 1...5 |
| " | X | * NC-Ready | NC-REady simulation |

Remark: PC board 03320 (replaced by the new layout 03322) can also be used; strappings as per section 9.10

9.12 Position Control 03325

Replaced 03323

9.12.1 Fixed Strappings

| Type | Designation | Signal | Closed/Open | Remarks |
|---------------|-------------|---------|-------------|---------|
| Single jumper | S1 | S board | open | Address |
| " | S2 | S board | open | " |
| Single jumper | L-K | M-EXT | " | |
| " | R-S | M-EXT | " | |
| " | T-U * | 0 V | closed | |

- 1 actual values input
- 5 command value outputs
- 14 BIT DAC, $1 \text{ VELO} = \frac{10 \text{ V}}{8192}$
- ULA IC
- applicable in conjunction with PC board 03315

* PCB track

Fixed Strappings

| Type | Designation | Signal | Closed/Open | Remarks |
|---------------|-------------|--------|-------------|---------|
| Single jumper | WJ1 | | open | Wait |
| " | WJ2 | | " | " |
| " | WJ3 | | closed | " |
| " | WJ4 | | " | " |
| Single jumper | W13 | | open | - |
| " | W14 | | " | - |

* Connection WJ3 is on the tracer

9.12.2 Variable Strappings - Command Value Output

| Type | Designation | Signal | Meaning | Standard | Special |
|---------------|-------------|--------|-----------|----------|-------------|
| Single jumper | W7 | CVG1 | 1st. axis | closed | see section |
| " | W8 | 0 V | 1st. axis | " | "Interface" |
| " | W11 | CVG2 | 2nd. axis | " | |
| " | W12 | 0 V | 2nd. axis | " | |
| " | W3 | CVG3 | 3rd. axis | " | |
| " | W4 | 0 V | 3rd. axis | " | |
| " | W9 | CVG5 | 4th. axis | " | |
| " | W10 | 0 V | 4th. axis | " | |
| " | W1 | CVG5 | 5th. axis | " | |
| " | W2 | 0 V | 5th. axis | " | |
| " | W5 | CVG6 | reserved | " | |
| " | W6 | 0 V | reserved | " | |

Note: There are no soldering pins for these jumpers, also, they are not soldered when delivered by the manufacturer.

9.12.3 Variable Strappings Servo-Ready-Simulation

| Type | Designation | Signal | Standard Signal, Velocity Ready | Special Control |
|----------------|-------------|--------|---------------------------------------|--------------------|
| | | | from drive | not monitored |
| Soldering pins | P-N | | open | closed |

9.12.4 Variable Strappings for Probe

No function

9.12.5 Settings for Command Value Output

| Type | Designation | Meaning | Standard Setting | Special Setting |
|---------------|-------------|-----------|--|---|
| Soldering pin | A-B/C33 | Com.val.1 | open | see section "Interface" chapter 8 |
| " | A-B/C49 | " " 2 | " | |
| " | A-B/C19 | " " 3 | " | |
| " | A-B/C41 | " " 4 | " | |
| " | A-B/C7 | " " 5 | " | |
| " | A-B/C27 | reserve | • | |
| Soldering pin | A-B/R26 | Com.val.1 | A  B | see section "Interface" chapter 8 |
| " | A-B/R36 | " " 2 | " | |
| " | A-B/R16 | " " 3 | " | |
| " | A-B/R31 | " " 4 | " | |
| " | A-B/R11 | " " 5 | " | |
| " | A-B/R21 | reserve | " | |

9.13 Position Control 03340

This board was shipped in low quantities.

Characteristics of version A: 3 command values, 3 actual values.

Probe input for 3T and 3M with 3 axes, one PCB.

Version B: 2 command values, 2 actual values, for 3M with more than 3 axes.

Version A or B: 12 BIT DAC, ULA component, no integrated EXE, command value output as 03320; actual value - only differential input.

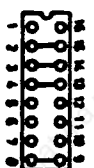
| Type | Designation | Signal | Closed/Open | Remarks |
|--|---|--------|--|-----------|
| Single jumper | C D | | open | |
| " | K H | + 5 V | " | |
| Single jumper | Lo  N M | | | Ground |
| Single jumper | S1 | Board- | open | version A |
| " | S1 | Select | closed | version B |
| Strapping socket S3  | 1-16 2-15 3-14 4-13 5-12 6-11 7-10 8-9 | | open closed " " open " " closed | Address |

| Type | Designation | Signal | Closed/Open | Remarks |
|--|-------------|--------|-------------|---------|
| Strapping socket S4  | 1-16 | | open | address |
| | 2-15 | | " | |
| | 3-14 | | " | |
| | 4-13 | | " | |
| | 5-12 | | closed | |
| | 6-11 | | open | |
| | 7-10 | | " | |
| | 8-9 | | " | |

Variable Setting for Probe

| Type | Designation | Signal | Standard | |
|----------------|-------------|--------|----------|---|
| Soldering pins | A-B R46 | | | Other settings, dependent on probe output |
| " | A-B R47 | | open | |
| Wire | X347.1--F | | closed | See section "Interface" |
| " | X347.5--0V | | | |

9.14 Position Control 03350

Replaced 03310/03323

9.14.1 Fixed Strappings

| Type | Designation | Signal | Closed/Open | Remarks |
|---------------|-------------|--------|-------------|---------|
| Single jumper | S1 | - | open | |
| " | S2 | - | " | |
| Single jumper | S3 | SPBC1 | open | address |
| " | S4 | SPCB2 | " | " |
| Single jumper | L-K | M-EXT | open | |
| " | R-S | M-EXT | " * | |
| " | V-W | M-EXT | open | |
| " | T-U | 0 V | closed * | |
| Single jumper | W7 | | open | Wait |
| " | W8 | | " | |
| " | W9 | | closed * | |
| " | W 10 | | open | |

* Connection W9 is on trace

9.14.2 Fixed Strappings for EXE

| Type | Designation | Signal | Option W/O Integrated EXE | Option with Integrated EXE |
|-----------|-------------|--------|---------------------------|----------------------------|
| Strapping | 1-16 | - | closed | open |
| socket | 2-15 | - | " | " |
| X1:Z-axis | 3-14 | *SDMB | " | " |
| X3:X-axis | 4-13 | SDMB | " | " |
| w/o | 5-12 | *SDMA | " | " |
| op- | 6-11 | SDMA | " | " |
| tion | 7-10 | *SDMZ | " | " |
| | 8-9 | SDMZ | " | " |
| with | | | | |
| op- | | | | |
| tion | | | | |

Strapping socket X2 for spindle, always without integrated EXE.

9.14.3 Variable Settings for Probes (see section 9.9.3)

9.14.4 Variable Strapping for Servo-Ready-Simulation (see section 9.12.3)

9.14.5 Variable Strappings - Command Value Output

| Type | Designation | Signal | Command Value Meaning | Standard | Special |
|---------------|-------------|--------|-----------------------|----------|---------|
| Single jumper | W1 | CVG1 | 1st. axis | closed | see the |
| " | W2 | 0 V | 1st. axis | " | "Inter- |
| " | W3 | CVG2 | 2nd. axis | " | face" |
| " | W4 | 0 V | 2nd. axis | " | section |
| " | W5 | CVG3 | 3rd. axis | " | |
| " | W6 | 0 V | 3rd. axis | " | |

Note: There are no soldering pins for these jumpers; also, they are not soldered when delivered by the manufacturer.

9.14.6 Settings for Command Value Output

| Type | Designation | Command Value Meaning | Standard | Special |
|----------------|-------------|-----------------------|----------|-------------|
| Soldering pins | A-B/C18 | Comm. value 1 | open | see section |
| " | A-B/C19 | Comm. value 2 | " | " |
| " | A-B/C35 | Comm. value 3 | " | "Interface" |
| Soldering pins | A-B/R21 | | | see section |
| " | A-B/R22 | | | " |
| " | A-B/R23 | | | "Interface" |

9.15 Integrated EXE, 03390, 03395

These boards are assembled on the position control boards 03315 and 03350. They are optional boards.

No changes may be executed on these boards.

9.16 I/O Board 03400

Fixed strappings for basic version 0:

Strapping socket X1 without jumper.

Versions 2 and 3

| Type | Designation | Signal/Meaning | Fixed strappings | Strappings acc. to PC Program |
|--|-------------|----------------|------------------|-------------------------------|
| Strapping socket X1  | 1-16 | Address | - | x |
| | 2-15 | " | - | x |
| | 3-14 | " | - | x |
| | 4-13 | " | open | - |
| | 5-12 | free | " | - |
| | 6-11 | " | " | - |
| | 7-10 | " | " | - |
| | 8-9 | " | " | - |

* see section 9.30

9.16a I/O Board 03 401

Address coding socket S1:



| Link designation | Address Byte value |
|------------------|--------------------|
| WA 4 | 8 |
| WA 5 | 16 |
| WA 6 | 32 |
| WA 7 | 64 |

9.17 Input Board 03410

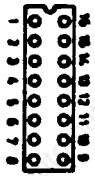
| Type | Designation | Signal/ Meaning | Fixed strappings | Strappings acc. to PC Program * |
|--|----------------|--------------------|------------------|------------------------------------|
| Strapping socket X1 | | w/o effect | - | - |
| Strapping X2  | 1-16 | Address | - | x |
| | 2-15 | " | - | x |
| | 3-14 | " | open | - |
| | 4-13 | " | " | - |
| | 5-12 | " | " | - |
| | 6-11 | " | " | - |
| | 7-10 | " | " | - |
| | 8-9 | free | " | - |
| Single jumper " | A - B C - D | MEXT MEXT | closed " | - - |

9.18 Output Board 03421

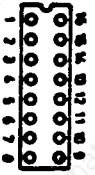
| Type | Designation | Signal/ Meaning | Fixed strappings | Strappings acc. to PC Program * |
|---|--|----------------------------------|--|------------------------------------|
| Strapping socket X1  | 1-16 | Address | - | x |
| | 2-15 | " | - | x |
| | 3-14 | " | - | x |
| | 4-13 | " | open | - |
| | 5-12 | " | " | - |
| | 6-11 | " | " | - |
| | 7-10 | " | " | - |
| | 8-9 | " | " | - |
| Single jumper " " " " " " | S1 S2 B1 B2 B3 A - B C - D | MEXT MOUT | open " closed " " open " | - - - - - - - |

9.19 I/O Board 03450

| Type | Designation | Signal/ Meaning | Fixed strappings | Strappings acc. to PC Program * |
|---|-------------|--------------------|------------------|------------------------------------|
| Strapping socket X1 | | w/o effect | - | - |
| Strapping socket X2  ** | 1-16 | Address | closed | - |
| | 2-15 | " | " | - |
| | 3-14 | " | open/closed ** | - |
| | 4-13 | " | open | - |
| | 5-12 | " | - | x |
| | 6-11 | " | - | x |
| | 7-10 | " | - | x |
| 8-9 | " | - | x | |
| Single jumper | A-B | MEXT | open | - |
| " | D-C | Address | " | - |
| " | D-E | " | " | - |

** Closed on versions AA and AB
Open on version AC

* see section 9.31

9.20 Output Board 03461

| Type | Designation | Signal/ Meaning | Fixed strapping | Strappings acc. to PC Program * |
|---|-------------|--------------------|-----------------|------------------------------------|
| Strapping socket S1 | | w/o effect | - | - |
| Strapping socket S0  | S2 | Address | - | x |
| | S3 | " | - | x |
| | S4 | " | - | x |
| | S5 | " | - | x |
| | S6 | " | - | x |
| | ** S7 | " | open | - |
| | S8 | " | closed/open ** | - |
| S9 | " | closed | - | |
| Single jumper | S18 | w/o effect | - | - |
| " | S19 | " " | - | - |

** Closed on versions AA and AB

Open on version AC

* see section 9.31

9.21 Power Supply 03500 (Type designation 6EV3 054...)

Fixed strapping for 03502

| Type | Designation | Closed/Open | Remarks |
|--|-------------|-------------|------------------------------|
| Strapping socket X1  | 1-16 | closed | Clear |
| | 2-15 | " | Under voltage +24 V |
| | 3-14 | " | Under voltage + 5 V |
| | 4-13 | " | Under voltage + 15 V |
| | 5-12 | " | Under voltage + 15 V |
| | 6-11 | " | Under voltage - 15 V |
| | 7-10 | " | Voltage monitor |
| | 8-9 | " | Collective signals |
| Single jumper | S-T | closed | Thyristor (over voltage 5 V) |
| " | Z-Y 1) | " | Battery voltage |
| " | ZA-ZB | " | + 15 V monitor |
| " | ZC-ZD | " | - 15 V monitor |
| " | ZY-ZZ | " | VCC RAM |
| " | X6 2) | " | Monitor |
| " | ZG-ZH | " | Current limit |

1) In power supply 501, designation U-V

2) This jumper is not present in power supply 501

X2 and X3 are sockets for factory tests.

9.22 Power Supply 03510

No strappings

9.23 Operator Panel 03700 (only basic versions 0 and 2)

Fixed strappings

| Type | Designation | Closed/Open | Remarks |
|------|-------------|---|-----------------------|
| Pin | DA-DB |  | Test jumper ca. 10 mΩ |
| " | EA-EB | - | 0.1 μF |
| " | LA-LB | closed | 5 V load separation |

9.24 Operator Panel 03710 (Versions 0 and 2)

No jumpers

9.25 Machine Control Panel 03720

No jumpers

9.26 Operator Panel 03770 (only Version 3) : **Keyboard PCB**9.27 Operator Panel 03780 (Version 3) : **Interface PCB**

Fixed strapping

Single jumper A-B,closed

9.28 Couple Board 03800 A

Fixed strappings

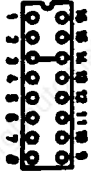
| Type | Designation | Signal | Closed/Open | Remarks |
|---|-------------|--------|-------------|--|
| Strapping socket P1  | 1-16 | | open | Test point Test jumper for extension unit |
| | 2-15 | | " | |
| | 3-14 | | closed | |
| | 4-13 | | open | |
| | 5-12 | | " | |
| | 6-11 | | " | |
| | 7-10 | | " | |
| | 8-9 | | " | |

Variable strappings

| Type | Designation | Signal | Standard, no output block at NC faults | Special, PC output block |
|---------------|-------------|--------|--|-----------------------------|
| Single jumper | A-B | | closed | open |
| " | C-B | | open | closed |

9.29 Video Interface 03810 (only Version 3)



Fixed strappings

| Type | Designation | Signal | Closed/Open | Remarks |
|------------------------|-------------|--------|-------------|-------------|
| Strapping socket S1 | 19 | | open | address |
| | 18 | | closed | " |
| | 17 | | " | " |
| | 16 | | open | " |
| | 15 | | closed | " |
| | 14 | | " | " |
| | 13 | | " | " |
| | 12 | | " | " |
| Single jumper | W1 | | open | Screen Type |
| " | W2 | | closed | " |
| " | W3 | | " | " |
| " | A-B | | open | |
| " | C-D | | " | |

9.30 Video Interface 03811 (Version 3)

Replacing type 03810

Fixed strappings

| Type | Designation | Signal | Closed/Open | Remarks |
|---|-------------|--------|---|-----------------|
| Strapping socket S2 | 12 | | open | address 12 |
| | 13 | | " | " 13 |
| | 14 | | " | " 14 |
| | 15 | | " | " 15 |
| | 16 | | closed | " 16 |
| | 17 | | open | " 17 |
| | 18 | | " | " 18 |
| | 19 | | closed | " 19 |
| Single jumper | A B | | open | Hardware |
| " | C D | | " | designation |
| " | E F | | " | Ground shield |
| " | K L | | closed | Screen blanking |
| " | M N | | open | " " |
|  | S1 | VAB9 |  | Operating mode |

9.31 List of Strapping Possibilities (Addressing) of the I/O Boards according to the PC Program

The boards can be plugged randomly into the frame.
Each board is strapped for an address range.

| Byte Adr | 03400 48 I 24 O (6 Bytes) (3 Bytes) X1 | 03410 96 I (2x6 Bytes) X2 | 03421 48 O (2x3 Bytes) X1 | 03421 48 I (2x3 Bytes) X1 | 03450 * 32 I 32 O (4 Bytes) (4 Bytes) X2 | 03460 ** 16 O (2 Bytes) S0 |
|----------|---|------------------------------------|------------------------------------|------------------------------------|---|-------------------------------------|
| 0 | | | | | | |
| 1 | | | | | | |
| 2 | | | | | | |
| 3 | | | | | | |
| 4 | | | | | | |
| 5 | | | | | | |
| 6 | | | | | | |
| 7 | | | | | | |
| 8 | | | | | | |
| 9 | | | | | | |
| 10 | | | | | | |
| 11 | | | | | | |
| 12 | | | | | | |
| 13 | | | | | | |
| 14 | | | | | | |
| 15 | | | | | | |
| 16 | | | | | | |
| 17 | | | | | | |
| 18 | | | | | | |
| 19 | | | | | | |
| 20 | | | | | | |
| 21 | | | | | | |
| 22 | | | | | | |
| 23 | | | | | | |
| 24 | | | | | | |
| 25 | | | | | | |
| 26 | | | | | | |
| 27 | | | | | | |
| 28 | | | | | | |
| 29 | | | | | | |
| 30 | | | | | | |
| 31 | | | | | | |

* On boards with edition AC, jumper 3-14 is omitted
** On boards with edition AC, jumper 8-11 is omitted

| Byte Adr | 03400 48 I 24 O (6 Bytes) (3 Bytes) | 03410 96 I (2x6 Bytes) | 03421 48 O (2x3 Bytes) | 03421 48 O (2x3 Bytes) | 03450 * 32 I 32 O (4 Bytes) (4 Bytes) | 03460 ** 16 O (2 Bytes) |
|----------|---|------------------------------|------------------------------|------------------------------|---|-------------------------------|
| | | | | | | |
| 32 | | | | | | |
| 33 | | | | | | |
| 34 | | | | | | |
| 35 | | | | | | |
| 36 | | | | | | |
| 37 | | | | | | |
| 38 | | | | | | |
| 39 | | | | | | |
| 40 | | | | | | |
| 41 | | | | | | |
| 42 | | | | | | |
| 43 | | | | | | |
| 44 | | | | | | |
| 45 | | | | | | |
| 46 | | | | | | |
| 47 | | | | | | |
| 48 | | | | | | |
| 49 | | | | | | |
| 50 | | | | | | |
| 51 | | | | | | |
| 52 | | | | | | |
| 53 | | | | | | |
| 54 | | | | | | |
| 55 | | | | | | |
| 56 | | | | | | |
| 57 | | | | | | |
| 58 | | | | | | |
| 59 | | | | | | |
| 60 | | | | | | |
| 61 | | | | | | |
| 62 | | | | | | |
| 63 | | | | | | |



Addresses always locked



Addresses may be used on other boards

* On boards with edition AC, jumper 3-14 is omitted

** On boards with edition AC, jumper 8-11 is omitted

10 Engineering Panel and Test Board

CONTENT

10.1 Prerequisites

10.2 Test Board

2.1 Construction

2.2 Front Plate

2.3 Designation of Switches

10.3 States

3.1 Normal NC Operation

3.2 Deactivated Engineering Panel Program

3.3 Activated Engineering Panel Program

3.4 Engineering Panel Program - Hold-state

10.4 Functions

10.5 Sequence

5.1 Engineering Panel Program Activation

5.2 Display

5.3 Break Points

10.6 Engineering Panel Instructions

6.1 Display or Change Memory Content

6.2 Display or Change Register Content

6.3 Set Break Point

6.4 GO Instruction

6.5 Single Step

10.7 Input List

10.8 NC Address Lists

8.1 Overview

8.2 EPROM Memory

10.9 Access to PC with the NC-Engineering Panel

10.1 Prerequisites

- Hardware:

The CPU hardware of the NC, as well as the operator panel with its key board and display unit, must be functional. Test board 03220 must also be connected.

- Software:

The engineering panel software must be plugged into the test board. From the system program, EPROMs 31 and 32 at least, must be present on the 03200 EPROM board.

- Versions 0 and 2, respectively version 3, have different EPROMs for the engineering panel.

- The PC diagnosis program for version 3 also contains the normal engineering panel program.

10.2 Test Board 03220

10.2.1 Construction

The board contains the system and working memory for the engineering panel. The EPROM memory range for test engineering panel programs contains 20 k words. The engineering panel program, however, only uses 2 EPROM for PROM locations 71 and 72. The RAM range is 2 k words.

The board also contains the wait-state-generator, break point register, comparator circuit, address decoder, one LED, three push-buttons, and two switches.

10.2.2 Test board front plate:

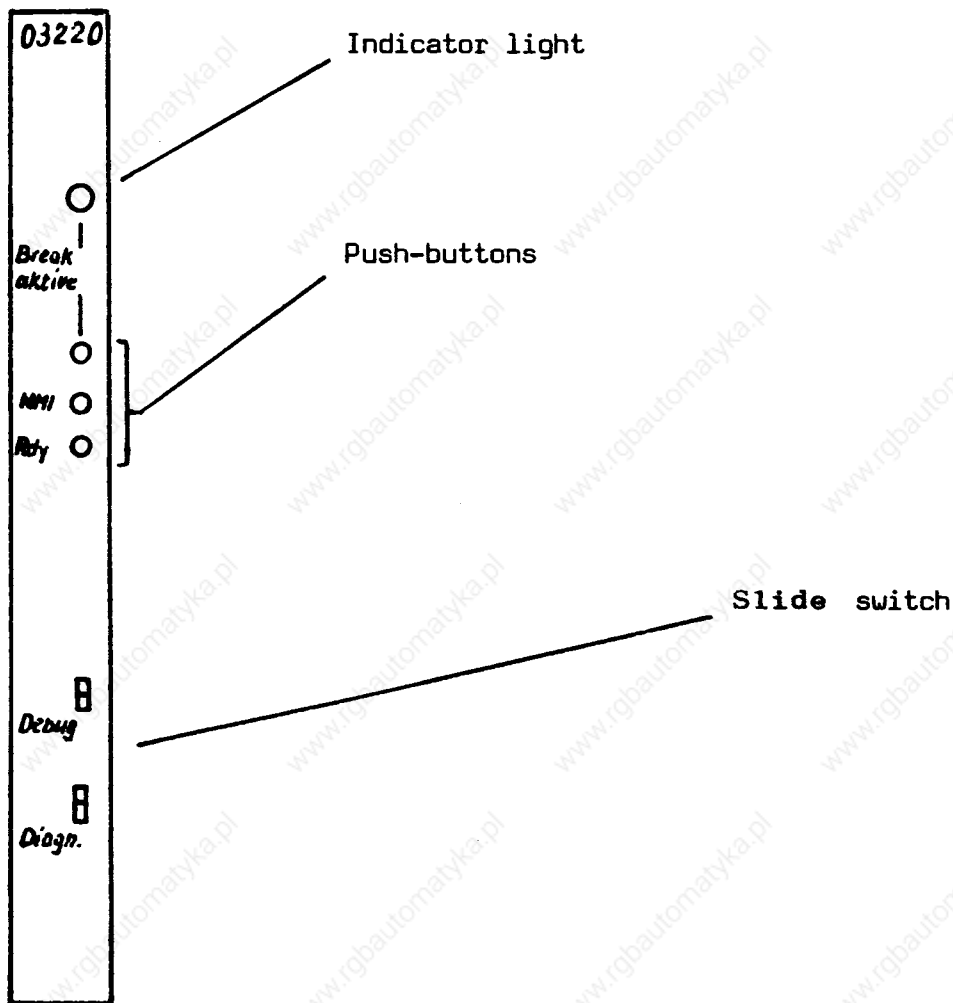

Explanations on next page

10.2.3 Designation of Switches and LED

LED: The LED lights up when the circuit of the test board is waiting for a break point.

Break push-button active: An already set break point is reactivated.

NMI push-button: Direct release of the break point; jump into the engineering panel program (NMI = NON MASKABLE INTERRUPT , high priority interrupt).

Push-button Rdy: Ready Simulation. If the CPU stops because false addresses have been entered, it can be started again by pressing "N" and the Rdy push-button.

Debug switch: Switch in lower position, jump into the engineering panel program.

Diagnostics switch: Switch in the lower position, jump into the PC diagnosis program (only for version 3).

10.3 States

10.3.1 Normal NC Operation

Switch S3 on the CPU is in upper position, the test board is not scanned. This operating mode must be used in normal operation.

10.3.2 Deactivated Engineering Panel Program

Switch S3 on CPU 03100 in lower position, debug switch in upper position. The engineering panel program does not scan the operator panel under these conditions. The control jumps into this state after PORESET (power clear). When a break point is reached or if the NMI button is activated, the control jumps into engineering panel program hold-state. One can return from hold-state into the system program with G LF. If switch S3 is in lower position but the test board is not connected, the CPU goes into a stop loop and the red LED on the CPU lights up.

Remark: In this state, in the data input operating mode, after the start-key "Control in Action" has been activated, read data type such as TE,%, etc, are not displayed.

10.3.3 Activated Engineering Panel Program

Switches S3 and Debug in lower position. The jump into this program can be made by pushing the debug switch into lower position after PORESET, or by activating G LF during engineering panel program hold-state. In this state, both system and engineering panel programs are running. The operator panel has available only keys for the engineering panel program. The remaining 18 characters of the lowest line are scanned by the engineering panel program in the display. STEP-instructions, all registers display, and register changes are not possible.

10.3.4 Engineering Panel Program - Hold-state

Switches S3 and Debug in lower position. The jump into this hold-state can be made by pushing the debug switch into lower position before PORESET or during the triggering of a break point. A jump to hold-state occurs during the triggering of a break point, even if the debug switch is in upper position.

The system program is inactive during hold-state; only the engineering panel program runs. This is indicated on the operator panel through the "Program runs" LED. The complete display and operator panel are available for the engineering panel program.

EPROMs 31 and 32 from the system software must be present on the 03200 PC board.

In this operating mode, signal "NC Rdy", and thus also ready 1 and 2, are revoked.

10.4 Functions

- Display and change memory contents (changes in RAM range only)
- Display and change register contents
- Set break points (program addresses, as well as addresses in data range)

- Start and stop program sequence
- Single-step operation with display

10.5 Sequence

10.5.1 Engineering Panel Activation

The test board is scanned when the S3 switch on the CPU is in lower position. The engineering panel program is activated with the debug switch of the test board. Data (1 word) can be displayed and changed, or break points can be set and activated in engineering panel mode, while the system program is running. In engineering panel program hold-state, the CPU runs in a loop in the engineering panel program and waits for inputs from the operator, whereby all interrupt levels are locked out. The hold-state can be triggered by:

- Arrival at a break point
 - NMI key activation
- (Stop via NMI interrupt,
at random positions in
the program)

The hold-state is indicated by the "Program runs" LED.

When stopping via an interrupt (NMI or single-step), all registers are stored, so that the program may be restarted from the same position. After stopping through an interrupt, all CPU registers can be displayed or changed.

The program can be restarted with a GO or STEP instruction.

Hold-state "H" :

- The CPU waits for input instructions
- All interrupt flags in the CPU are cleared (interrupts locked)
- The CPU can be within the NMI level, or in the lowest level (B)
- Display in the register page:

IM = 80 XX \longrightarrow CPU runs on NMI or Single-step level,
the page shows the actual register state

or

IM = 00 XX → CPU runs in the lowest level. The page does not show the actual register state, but that of the last break point or single-step.
Single-step operation is not possible.

10.5.2 Display

If the engineering panel is active ("Activated Engineering Panel" state), it can control the display like in normal operating mode. Only the last 18 characters of the lowest line are controlled by the engineering panel program, and are used as input-feedback and output line. In the hold-state the entire display is available for showing the contents of the registers.

10.5.3 Break Points

If the processor should be stopped at a particular address, when the program is in ROM range, this must be accomplished through a hardware comparison (i.e. the CPU is stopped via an interrupt when the desired address appears on the address bus). Since CPU 8086, for higher speed, has a 6 byte buffer memory used as "instructions queue", the reading of an instruction is not identical to its execution. Depending on the length of an instruction, the stop 1-5 instruction can thus be issued too soon. If the instruction queue is empty, i.e. if several instructions with very short execution times were issued just before, the CPU will only be able to stop on the immediately following address. For this reason, it cannot be established after an NMI, whether the processor stopped before or after the desired address, i.e. it is not possible to make an exact stop of the execution of an instruction by subsequent processing of a queue.

Example of error possibility :



The processor fetches the MOV instruction before it executes the JMP instruction --> the processor stops, even though the MOV instruction is not executed in the current program sequence.

From the stop address displayed, the operator can determine whether or not the processor has stopped on the desired address.

If the break point was set to an address within data range, the processor will always stop after the execution of the instruction.

Hereby, it is not only possible to stop on certain data addresses, but also certain data contents.

The break point register can be set while the program is running. The NMI enable bit can be set directly, with the set or break active key. This activation via the break active key is also scanned continuously during normal program sequence. A break point can thus be activated, even if the debug switch is not in lower position. The resulting interrupt stops the running program and starts the engineering panel routine. Engineering panel instructions can now be entered (even without resetting the debug switch).

To prevent the break points from being masked, the NMI (non maskable interrupt) is used. This NMI can also be triggered by hand, via the NMI key on the test board, independently of the setting of a break point. The NMI is stored with a flip-flop, which is cleared after the execution of the interrupt service routine. After the stop of an NMI interrupt, the lowest line of the display shows the program address (CS and IP register) of the next instruction to be executed.

10.6 Engineering Panel Instructions

Each instruction must be terminated with the **LF** key.

Bracket [...] → instructions may be omitted.

10.6.1 Display and Change of Memory Content

M **LF** → Display: s s s s - o o o o - d d d d
 Segment Offset Data value

- After M is entered, the address (segment and offset) of the last M-instruction is outputted automatically, and the contents of addressed data word are displayed.
- A segment address can be changed by entering **S** and typing in the new address.
- An offset address can be changed by entering **L** and typing in the new address.
- The data word can be changed with **X** and the input of new data. (Input as word: high byte - low byte)
- Incrementing with key **↓** by 2, and Decrementing with key **↑** by 2, are followed by the display of the next or preceding word; changes can then be executed, as described above.
- The M-instruction is terminated automatically, if any other than the function keys mentioned above is activated, or through the input of the **↻** LF end-instruction.

When entering new offset and segment addresses, care should be taken, that no address which the processor is unable to access due to its hardware, be created (the hardware does not give the "Ready" signal to the CPU). In such cases, the CPU stops and must be restarted by pressing the N and Ready keys.

10.6.2 Display and Change of Register Contents

- Display of all registers

R **LF**

- Register display and change

X **n** **LF**

↑
Register number

e.g. X C LF old value is displayed - input of new value LF

After the X-instruction is entered, the register designation appears, and the contents of the register are in the input line. After this, the contents of the register can be changed and/or it can be incremented to the next register. Incrementing: LF.

Register number:

| | | | |
|----|---|---|-------------------|
| AX | : | 0 | Accumulator |
| BX | : | 1 | Base register |
| CX | : | 2 | Count register |
| DX | : | 3 | Data register |
| SI | : | 4 | Source index |
| DI | : | 5 | Destination index |
| DS | : | 6 | Data segment |
| ES | : | 7 | Extra segment |
| SS | : | 8 | Stack segment |
| SP | : | 9 | Stack pointer |

| | | | |
|----|---|----|---------------------------|
| BP | : | .0 | BASE pointer |
| FL | : | .1 | Status flag |
| IM | : | .2 | (Interrupt mask register) |
| CS | : | .3 | Code segment |
| IP | : | .4 | Instruction pointer |

10.6.3 Break Point Setting

The stop address is composed of segment- (code or data segment) and offset address. When setting the break point to a data cell, it must be stated whether the stop should be on a byte, and whether on -WRITE- or -READ & WRITE-. The break point can be activated with the SET instruction or by pressing the "Break active" key.

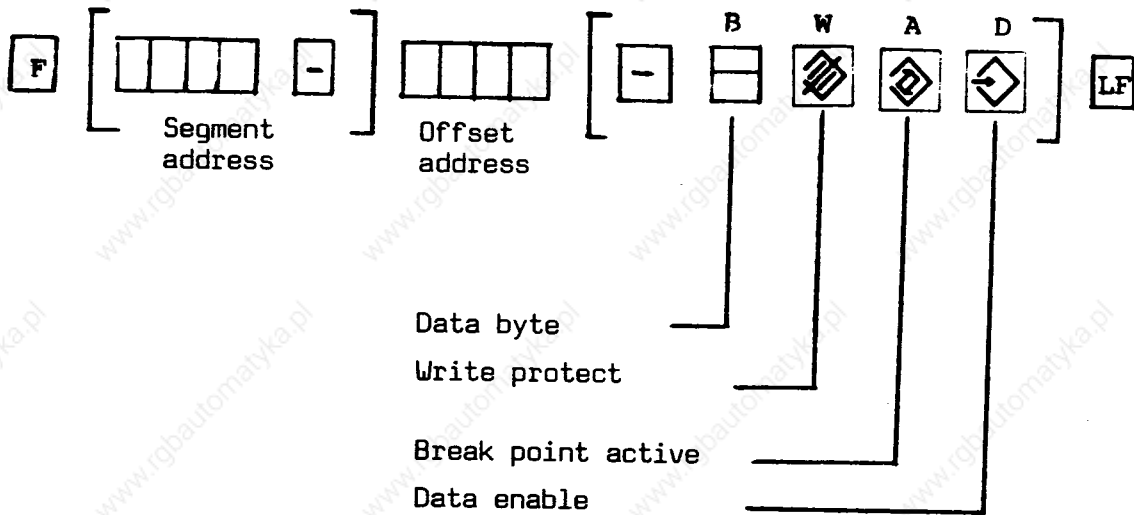

After the break point is reached, the comparator circuit becomes inactive automatically.

F A LF = Reactivation (A ≙ A)
F LF = Display of break points and control bits

Example of address input :

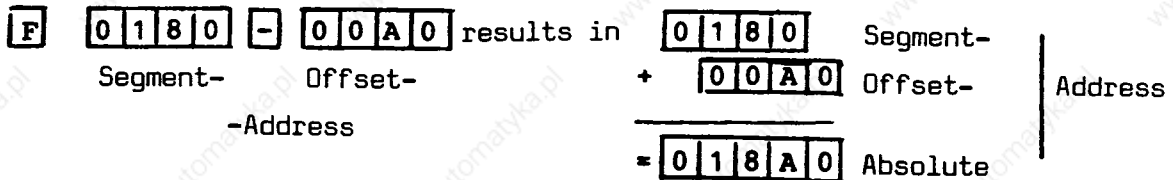

Meaning of B, W, A, D

- B Must be entered if the break point should be activated on a byte address.
- W The break point is activated only when writing; when W is omitted, it stops at read and write.
- A Break point activation
- D When D is entered, the data content at which the break point should be activated, must be entered under K.

The sequence order B, W, A, D must be respected during input.

Input under K :

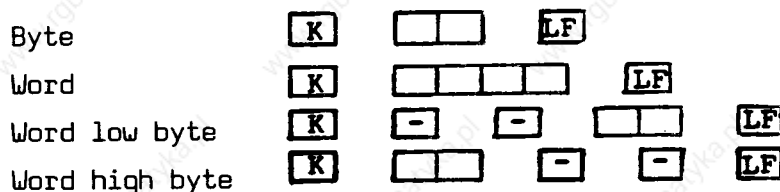

10.6.4 GO Instruction -Start Instruction for Simulation

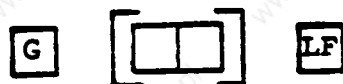

Loop counter

The engineering panel routine is exited, and the CPU continues from the position where the NMI interrupt occurred or, if the instruction pointer (and perhaps the code segment register) was changed, from the corresponding program address. The CPU will hereby start, and will continue running until the break point circuit generates another NMI.

With the aid of a loop counter, the number of break point loops which should be executed in sequence automatically, can be selected. (0 = 1 loop). The CPU makes the final stop and the stop address is displayed only after the count-down of this loop counter. If no break points are set, the CPU runs until the NMI key is activated.

If, after G LF instruction, the debug switch is pushed from lower to upper position, the system will again be in "Engineering panel program deactivated" status.

10.6.4 Single-step Instruction - CPU runs in single-step operating mode

(1 step = 1 instruction)

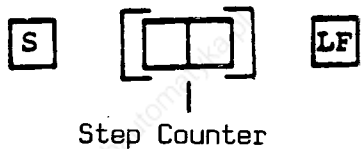

Within the program, the CPU starts at the point where a NMI interrupt occurred, or at an address newly written into the IP (instruction pointer). The CPU stops after each instruction execution, and can be sequenced manually with the LF key.

The number of steps (0-255) can be selected with the step counter; these steps should be executed automatically. (0 = 1 STEP)

After each step, respectively after the execution of the preselected number of steps, the current program address is displayed automatically (= the address of the next instruction to be executed).

The display shows:

CS = ---- IP = ----

If an R-instruction was issued before the step instruction, then the register page is up-dated after each step, automatically.

Error Possibilities in Single-step Operation :

In single-step operation, if a high-priority interrupt appears before the execution of an instruction, the CPU goes onto the higher level, and before executing the 1st. instruction, it executes the single-step interrupt routine.

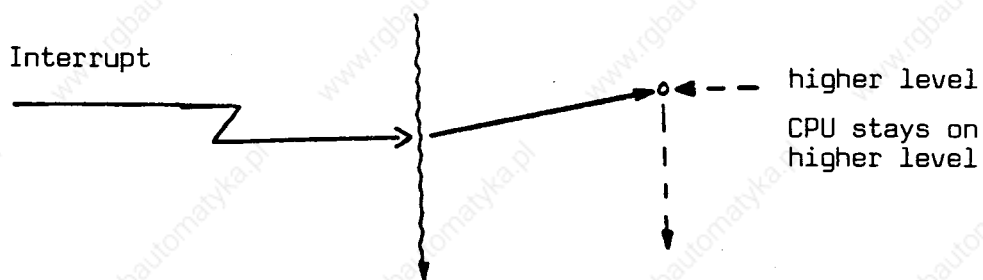

Test Program in Single-step Operating Mode

If an "IRET" instruction should be executed in single-step mode, and should an interrupt arrive at this point with higher priority than the return level, the processor will jump into the new interrupt routine, and the single-step interrupt routine is not executed.

→ When testing with single-step, if at all possible, the other levels should be masked !

Example:

Interrupt locked by setting a mask with:

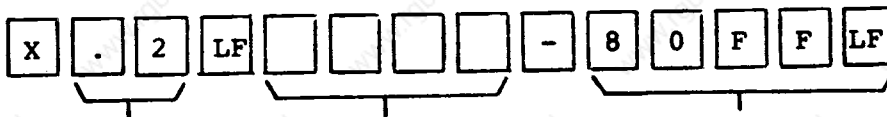

IM (=interrupt
register, see
12.7)

Old content
is displayed

New value input

10.7 INPUT LIST

| | |
|-------------------------------------|--|
| CLEAR KEY (CLEARS LAST CHARACTER) | |
| INSTRUCTION TRANSFER | (ECHO /*/) |
| HEX NUMBERS (=NR. FOR REGISTERS) | |
| 0 AX | <p>LEADING ZEROES MAY BE OMITTED WHEN ENTERING NUMBERS (EXCEPT FOR "K" INSTRUCTIONS)</p> |
| 1 BX | |
| 2 CX | |
| 3 DX | |
| 4 SI | |
| 5 DI | |
| 6 DS | |
| 7 ES | |
| 8 SS | |
| 9 SP | |
| A BP | |
| B FL | |
| C IM | |
| D CS | |
| E IP | |
| F - | |

INSTRUCTIONS:

- * GO (LOOP COUNTER \emptyset = FF)
- * STEP (LOOP COUNTER \emptyset = FF)
NEXT STEP
- DISPLAY MEMORY
- CHANGE SEGMENT
- CHANGE OFFSET
- CHANGE DATA WORD
- INCREMENT OFFSET (+2)
- DECREMENT OFFSET (-2)
- CLEAR MIM DISPLAY ADDRESS

- * DISPLAY ALL REGISTERS
- * DISPLAY/CHANGE REGISTER
NEXT REGISTER
- DISPLAY BREAK POINT ADDRESS
- ACTIVATE BREAK POINT
- SET BREAK POINT, ADDRESS + CONTROL
- DISPLAY BREAK POINT, DATA COMPARATOR
- SET BREAK POINT, DATA COMPARATOR
- BYTE
- WORD
- WORD MASK HIGH BYTE
- WORD MASK LOW BYTE
- END OF "DISPLAY MEMORY", "CHANGE REGISTER MODE"
- ERROR CHARACTER ON DISPLAY

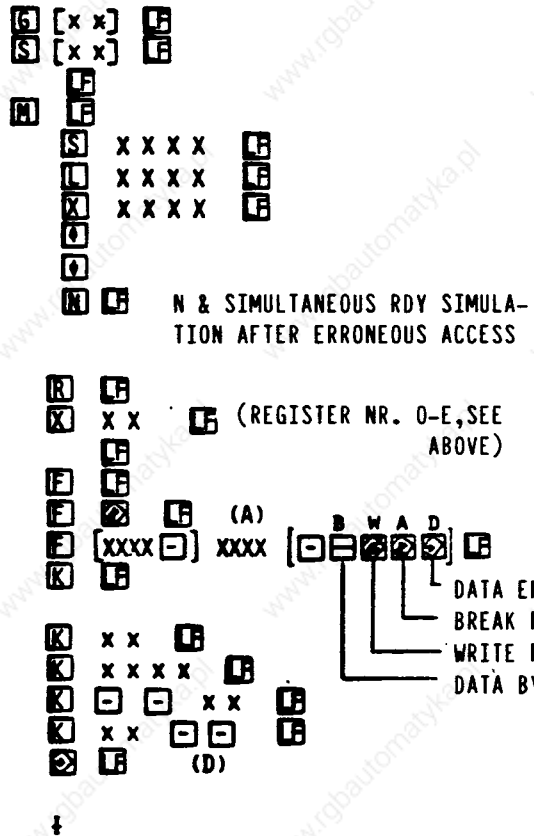

ISO Code with Parity Bit (HEXA Code)

| Character | ISO-Code (8 Bit) | Character | ISO-Code (8 Bit) |
|-----------|------------------|-----------|------------------|
| Z | A5 | @ | C0 |
| LF | 0A | A | 41 |
| CR | 8D | B | 42 |
| : | 3A | C | C3 |
| * | AA | D | 44 |
| CNTL NUL | 00 | E | C5 |
| Space | A0 | F | C6 |
| ! | 21 | G | 47 |
| " | 22 | H | 48 |
| | A3 | I | C9 |
| \$ | 24 | J | CA |
| & | A6 | K | 4B |
| ' | 27 | L | CC |
| (| 28 | M | 4D |
|) | A9 | N | 4E |
| + | 2B | O | CF |
| ; | AC | P | 50 |
| - | 2D | Q | D1 |
| . | 2E | R | D2 |
| / | AF | S | 53 |
| 0 | 30 | T | D4 |
| 1 | B1 | U | 55 |
| 2 | B2 | V | 56 |
| 3 | 33 | W | D7 |
| 4 | B4 | X | D8 |
| 5 | 35 | Y | 59 |
| 6 | 36 | Z | 5A |
| 7 | B7 | _ | DB |
| 8 | B8 | / | 5C |
| 9 | 39 | - | DD |
| : | BB | | |
| < | 3C | | |
| = | BD | | |
| > | BE | | |
| ? | 3F | | |

The information for user programs (PP and SP) in RAM memory 03210 or 03260 is stored in ISO code with parity bit. The ISO code is a subset of the ASCII code, but with parity bit, e.g. letter R in ISO code = D2; R in ASCII = 62.

10.8 NC Address Lists

10.8.1 Overview for Versions 0 and 2 :

| ADDRESS | | | Board |
|---------|-------|---|-------|
| Start | End | | |
| 00000 | 017FF | NMOS RAM CMOS RAM PERIPHERY | 03100 |
| 01800 | 057FF | | 03210 |
| 0E000 | 0FFFF | | 03310 |
| | | free | 03320 |
| 20000 | 2FFFF | PC | 03400 |
| | | ----- | |
| | 3FFFF | PC | 03800 |
| 40000 | 4FFFF | TEST | 03220 |
| | | free | |
| 60000 | 6FFFF | EPROM | |
| 70000 | 7FFFF | ----- EPROM | 03200 |

10.8.2 Overview for Version 3

| ADDRESS | | | Board |
|---------|-------|-----------------|-------|
| Start | End | | |
| 00000 | 017FF | NMOS RAM | 03100 |
| 01800 | 057FF | CMOS RAM | 03210 |
| 0E000 | 0FFFF | PERIPHERY | 03310 |
| 10000 | 10FFF | VIDEO INTERFACE | 03320 |
| | | | 03400 |
| 11000 | 1FFFF | free | |
| 20000 | 2FFFF | PC | 03810 |
| | | ----- | |
| | 3FFFF | PC | 03800 |
| 40000 | 4FFFF | TEST | |
| | | free | 03220 |
| 60000 | 6FFFF | EPROM | |
| | | | 03200 |
| 70000 | 7FFFF | EPROM | |

10.8.3 Board 03 200 (Operating System)

Address subordination, EPROM designation, locations

| Start Address | End Address | K- Words | Plug location | |
|---------------|-------------|-------------|---------------|-----|
| | | | H | L |
| 60000 | 61 FFF | 0-3 | D02 | D01 |
| 62000 | 63 FFF | 4-7 | D04 | D03 |
| 64000 | 65 FFF | 8-11 | D06 | D05 |
| 66000 | 67 FFF | 12-15 | D08 | D07 |
| 68000 | 69 FFF | 16-19 | D10 | D09 |
| 6A000 | 6B FFF | 20-23 | D12 | D11 |
| 6C000 | 6D FFF | 24-27 | D14 | D13 |
| 6E000 | 6F FFF | 28-31 | D16 | D15 |
| 70000 | 71 FFF | 32-35 | D18 | D17 |
| 72000 | 73 FFF | 36-39 | D20 | D19 |
| 74000 | 75 FFF | 40-43 | D22 | D21 |
| 76000 | 77 FFF | 44-47 | D24 | D23 |
| 78000 | 79 FFF | 48-51 | D26 | D25 |
| 7A000 | 7B FFF | 52-55 | D28 | D27 |
| 7C000 | 7D FFF | 56-59 | D30 | D29 |
| 7E000 | 7F FFF | 60-63 | D32 | D31 |

10.9 Access to PC with the NC-Engineering Panel

Note: all addresses are in hexadecimal system, without designation of index "H".

10.9.1 Converting PC to NC Address

PC address times 2

+ 20,000

e.g. PC address EAOF
= system data word 7, 2nd. byte

EAOF · 2 = 1D41E

+ 20000
3D41E

10.9.2 Reading and Setting of Inputs and Outputs of the I/O Boards

1. Test board 03220 must be connected.
2. Activate test board 03220 with switch S3 (int) on CPU 03100
3. NC ON (PORESET)
4. Debug-switch on the test board in lower position
5. Set break point

Edit key
↓
F 3000-D418-A-LF

6. Input for display

M LF

7. Read address

S 3E00 LF L0010LF

8. Display shows:

M*3E00* - 0010* - FF__

Display of input information

e.g. Machine control panel on input byte 8 through 13

Operating mode selector switch to reference point FFE_

Feed rate override switch to 120% FFE8

9. Input of next input byte

Activate key 

Display shows:

M*3E00* - 0012* - FF

Display of input information  ,byte 9

* See remarks under 10.4.3

10. Display of further input bytes

with key  increment

with key  decrement

11. Outputs setting

After an address is read, the corresponding outputs can be set.

Input X __ LF

e.g. X F F LF, i.e.

Output is only possible if jumper A-B (standard strapping) is present on coupling board 03800.

10.9.3 Direct Access of the I/O Boards through PC Interface without PC, with the Aid of the Engineering Panel

1. Board CPU PC is disconnected
2. PC coupling 03800 strapping socket P1 ,change from jumper 3-14 to 2-15.
3. The test board must be connected, and the debug switch must be in lower position.
4. CPU 03100 switch S3 should be on Test
5. Hardware reset (only engineering panel program possible)
6. Input for display

M LF

7. Read address

S 3E00* LF L 0010* LF

see the remark

*Remark to the address shown in the example:

Address 3E00 - 0010 corresponds to input word 8, i.e. machine control panel is on I/O board nr. 2, strapping socket X1 jumper 1-16.

For other addressings, see "address range I/O", section 10.8.5 .

8. Display shows:

M*3E00* - 0010* - FF _ _

Display according to input (see 10.4.2.8)

9. Outputs setting

The corresponding outputs can be set afetr the address has been read

Input X _ _ LF

e.g. FF ,all outputs of the output byte read.

10.9.4 Display ISTACK with the Engineering Panel

With PC 130 W, the display of ISTACK with the aid of the engineering panel program is only possible with the new system program.

Old: Edition 4/81 3WA12

Display not possible

New: Edition 10/81 3WA13

Display possible

1. PC-switch to Stop, to prevent clearing the ISTACK
2. NC OFF
3. Test board 03220 must be connected
4. Activate the test board with switch S3 on CPU 03100
5. Test board debug switch in lower position
6. NC ON (PORESET)
7. Set the break point
F 3000-D418-A-LF
8. G LF
9. Input for Display
M LF
10. Read address
S _ _ _ LF L _ _ _ LF
e.g. SD214 S3D75 LF L0008 LF
11. For other addresses, see lists in section 10.8

Notes to the PC

- 11.1 Prerequisites, Settings 130 WA
- 11.2 Prerequisites, Settings 130 WB
- 11.3 Function Blocks
- 11.4 Program Examples
- 11.5 Testing Aids
- 11.6 Trouble-shooting in the PC
 - 11.6.1 ISTACK
 - 11.6.2 BSTACK
- 11.7
- 11.8 PC Lists
 - 11.8.1 Memory Map 130 WA
 - 11.8.2 Address List 130 WA
 - 11.8.3 Memory Map Internal RAM 130 WA/130 WB
 - 11.8.4 SD Range 130 WA/130 WB
 - 11.8.5 Memory Map 130 WB
 - 11.8.6 Address List 130 WB
 - 11.8.7 Instructions Sets

11.1 Prerequisites, Settings for 130 WA

11.1.1 Assembly

11.1.1.1 PC 130 WA, central processing unit 6ES5-921-3WA

With receptacle for one EPROM module, for a maximum of 8k instructions for the user program.

This board also contains a RAM memory for 0.5k instructions for the user program.

EPROM module with memory for 4k instructions

Type 370 with 4 EPROM 2716

Type 820 with 2 EPROM 2532

EPROM module with memory for 8k instructions with option N20

Type 371 with 4 EPROM 2532

Type 820 with 4 EPROM 2532

The control is shipped from the factory with an EPROM containing a program, see section 11.4 .

Generalities concerning the memory modules

Because the EPROMs on memory modules 370 and 371 are soldered, the covers for the retraction of the modules can no longer be used. For this reason, we have available a different cover with slide :

Order number for the cover: C79451-A3079-C258

Order number for the slide: C79451-A3079-C259

Ordering address: GWK

The covers are also used with type 820.

The assembly of the cover and slide to the memory module is explained in a diagram.

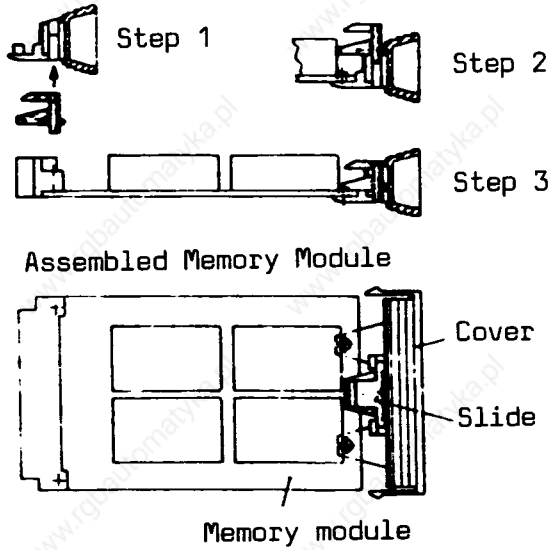

11.1.1.2 PC coupling board 03800 A

11.1.1.3 PC memory board 6ES5-350

For option N22 w/o EPROM memory

For option N23 with EPROM memory, 4k instructions

For option N24 with EPROM memory, 8k instructions

For option N25 with EPROM memory, 8k + 4k instructions

11.1.2 Settings

11.1.2.1 CPU 6ES5-921

No settings are necessary on the board.

The following jumpers are present:

Basic board U1: jumper A-B, C-D, K-L, P-Q

Complementary board U2: jumper A-B, D-E

EPROM module type 370/371: no jumpers

| Type 820 | Wire Jumper | |
|-----------------|-------------|--------|
| | W1 | W2 |
| 2k | open | open |
| 4k instructions | closed | open |
| 6k | open | closed |
| 8k instructions | closed | closed |

11.1.2.2 I/O boards 03400, 03410, 03421, 03450, 03460

Strapping according to the user program, see section 9.

11.1.2.3 S5 I/O boards 402-3, 445-3, 444-3, 432-3

Strappings according to user program, see section 9.

11.1.2.4 Coupling board 03800 A

No setting is necessary under normal circumstances.

The PC outputs are not locked when there is a fault in the NC. Should the ~~customer~~ want the PC outputs locked, jumper A-B must be removed, and jumper B-C must be inserted.

The controls are shipped with strappings 14-3 (command output lock for EXTENSION UNIT) on socket P1:

Socket P1

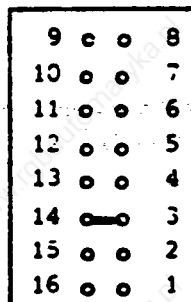

← BASP Extension Unit

← for test (see section 12)

11.1.2.5 Memory Board 6ES5-350

The memory board provides for a maximum of 12k words for the EPROM Range and 4k words for the RAM range.

OPTION N22: RAM 4.5 k EPROM 8 k

Strapping
socket

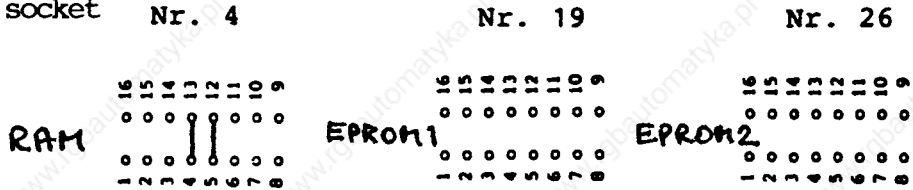

OPTION N23: RAM 4.5 k EPROM 12 k

Strapping
socket

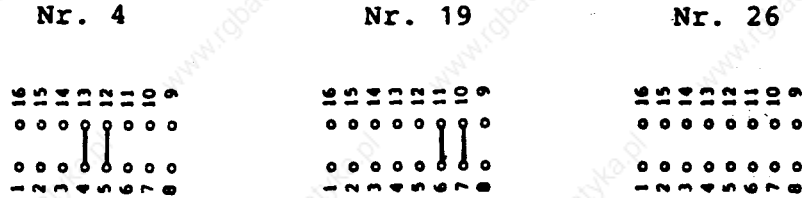

OPTION N24: RAM 4.5 k EPROM 16 k

Strapping
socket

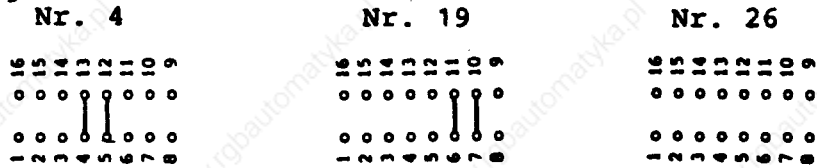

OPTION N25: RAM 4.5 k EPROM 20 k

Strapping
socket

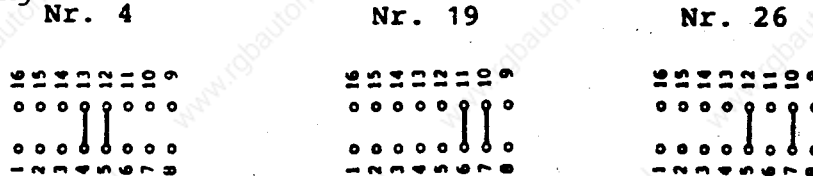

11.1.3 Function Test of the PC

11.1.3.1 PC-CPU :

After the NC and PC are switched on, the green LED of the PC-CPU must light up. If the red LED is lit instead, it could be due to the following causes:

- The switch of the PC-CPU is on Stop
- The PC RAM is in undefined state
Remedy: execute cancel 0, see section 4.3
- Memory addressed incorrectly (**Address coding**)
- Hardware fault of the PC-CPU
- No battery voltage
- Cycle time exceeded (watch-dog timer)

Check of the battery in the power supply

Further information in the system data.

These can be read out with PG 670, PC program correction (diagnostic program only for 3T/3M3), or the NC engineering panel. If at power-up, the PC is in Stop state, the NC-CPU 03100 will also go to Stop state.

See section 4.2 .

If the PC goes to Stop state during operation, the NC displays "PC fault".

LED significance:

If the red LED lights up, the PC is running in a stop loop. Access is possible with PG 670, PC program correction, or NC engineering panel.

If the green LED is lit, the PC is running in cyclic operation.

If both red and green LEDs are lit, the PC is running in the restart branch.

If no LED is lit, the voltage to the PC is lacking or there is a hardware fault in the PC.

11.1.3.2 Coupling board 03800 A:

Red LED "NC Fault": this LED indicates NC faults, but only if the A-B jumper is removed (outputs locked).

Red LED "Periphery Fault": this LED is lit continuously if no extension unit is connected. If there is a connected extension unit, it only lights up during malfunctions.

11.1.3.3 User Program

If no user program is yet available, or if the one available presents problems, the NC can be started with the program shipped with the control.

The RAM memory board 6ES5-340 can also be used for the testing of the user program.

The start address must be set properly:

Location nr. 51

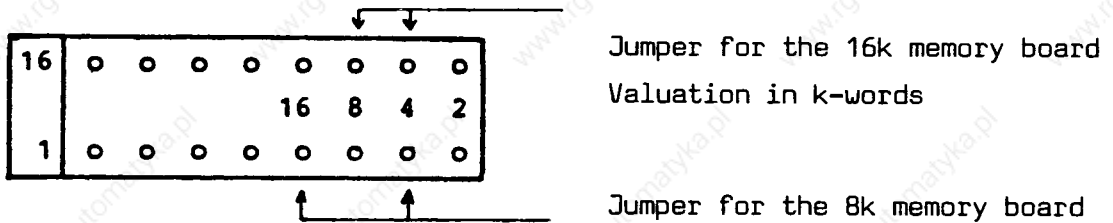

Location nr. 71 (masking) without jumpers.

11.2 Prerequisites, Settings for 130 WB

The 130 WB has been used instead of the 130 WA, since the middle of 1983.

11.2.1 Assembly

11.2.1.1 PC 130 WB, CPU 6ES5 921-3WB

With receptacle for 2 EPROM modules, respectively for a maximum of 16k instructions for the user program. The board also contains a RAM memory for 2.9k instructions for the user program.

11.2.1.2 EPROM modules

| | |
|------------|-----------------------------------|
| Basic unit | 1 module for 4k instructions |
| Option N32 | 1 module for 8k instructions |
| Option N34 | 2 modules for 2 x 8k instructions |

Type MS820 is used:

with 2 EPROMs 2532 for 4k,

with 4 EPROMs 2532 for 8k.

S5 modules 371 and 373 can be used for type 820.

Module 370 may not be used.

The 1st. module must be plugged into the upper receptacle.

11.2.1.3 PC coupling board 03800A, as for the 130 WA

11.2.2 Settings

11.2.2.1 CPU 130 WB

No settings are necessary on the board.

The following fixed strappings may not be changed.

| | |
|-------------------|------------------|
| Basic board U1 | Type 01101 (CPU) |
| Single jumper G-F | closed |
| Single jumper K-L | closed |

| | |
|------------------------|---------------------|
| Complementary board U2 | Type 01201 (memory) |
| Single jumper W1 | open |
| " " W2 | open |
| " " W3 | closed |
| " " W4 | open |
| " " W5 | closed |

11.2.2.2 EPROM module

Fixed strapping type 820, see 11.1.2.1

Modules 371, 373 have no strapping.

11.2.2.3 I/O boards, 03800 A, as in section 11.1

Remark: memory board 6ES5-350 is not included in the shipment.

11.2.3 Function test for the PC

11.2.3.1 PC-CPU

see section 11.1.3.1

The following distinguishes the 130WB from the 130 WA :
an additional "Restart" push-button.

The entire RAM memory can be cleared with this key (as with "Cancel 0")

The following sequence must be respected :

1. PC switch on Stop
2. Press the restart key, and simultaneously the hardware reset on the power supply
3. PC switch to Operation
4. PC switch on Stop
5. PC switch to Operation, afterwards the green LED must light up
6. Hardware reset, so that the NC is restarted

11.2.3.2 Coupling Board, see section 11.1.3.2

11.2.3.3 User Program

If no user program is available yet, or if there are problems with the existing user program, the NC can be started with the program shipped with the control.

The RAM memory board 6ES5-340 may also be used to test the user program.

The start address must be set correctly :

Location nr. 51

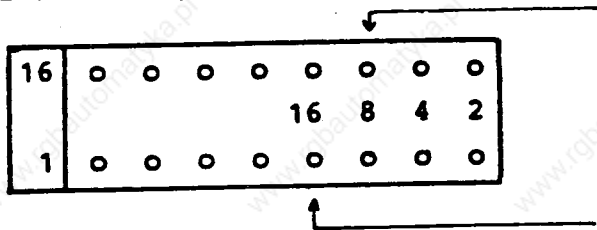

Jumper for 16k meory board

Valuation in k-words

Jumper for 8k memory board

Location nr. 71 (masking) without jumper.

Board 5-350 for 4k RAM :

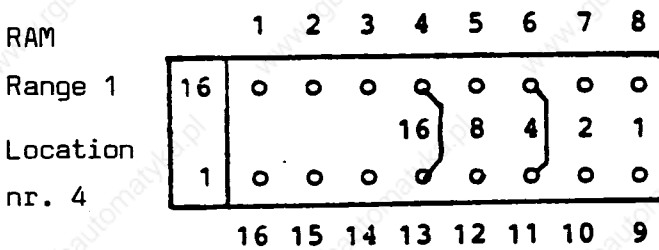

Valuation in

k-words

11.3 Function Blocks

11.3.1 Overview

| Block | Brief Description | Name |
|-------|-------------------|-------------------------------|
| 0 | ALARMST | Alarm controlled program |
| 11 | EINR-DB | Set up data block |
| 12 | HILFSFKT | Auxiliary function |
| 15 | AK3:AUT | Sequence control 3, automatic |
| 16 | BLOCK-TR | Block transfer |
| 20 | M-DECOD | M-decoder |
| 21 | S-UEBERG | S-transfer |
| 22 | DATANNC | Data transfer to NC |
| 24 | S-DECOD | S-decoder |
| 35 | SER 130W | Service unit 333-OBA |
| 36 | VERZOEG | Delay |
| 37 | STATUS 1 | Status display 1 |
| 40 | RI-AUSW 1 | Direction selection 1 |

Remark:

The function blocks for other systems have the same numbers and designation. For this reason, it is important to use only the right function blocks for System 3 (they are stored on a special diskette for System 3). The differentiation is done through the library number, respectively 130 WA/130 WB.

The same function blocks are used for versions 2 and 3.

11.3.2 Function Blocks Designation

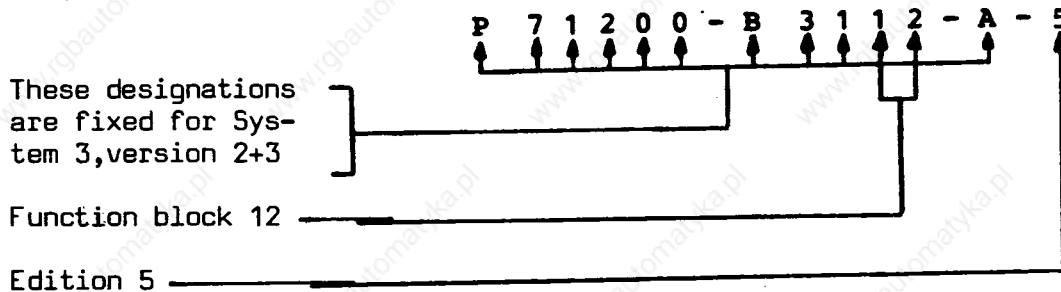
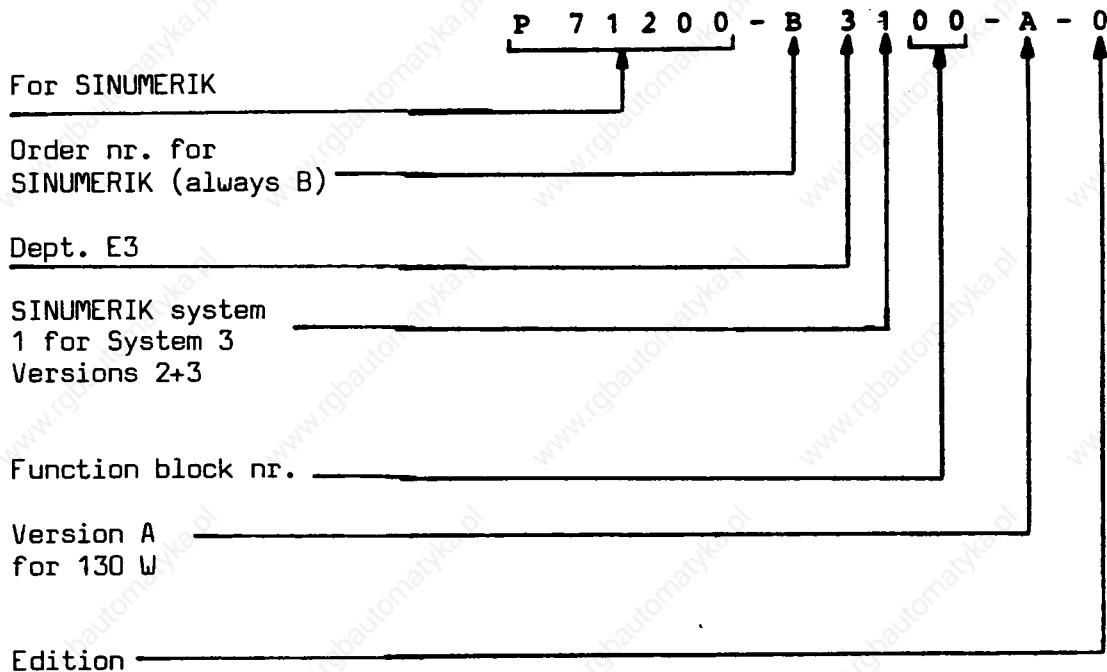

Note: The function blocks for version 4 have different designations, and are not functional in versions 2 and 3.

11.3.3 Function Blocks Description

FB12: HILFSFKT

Auxiliary functions

The task of the "Auxiliary functions" function block consists of:

- bringing the PC in a defined reset state,
- supplying signals used in other function blocks,
- exchanging the interface signals for the signal exchange NC/PC between flags and data block 9, and
- setting up data blocks 2 and 9 in the RAM range of the PC, at Start.

When the system is started (power-up or switching from "Stop" to "Operation" on the front plate of the CPU), the interface between NC and PC is brought in a defined start state. In addition, depending on the type of start, signal "Reset state" (at start) or "New start" (at start with reset) is issued.

If not already present, data blocks 2 and 9 are also set up. Signals "Reset state" and "New start" are issued as pulses.

During normal program execution, the signals corresponding to the NC are exchanged by the FB12 between the flags (FB0-17) and DB9, because the signal transfer between NC and PC occurs over DB9 (see diagram).

Detailed descriptions of the function blocks can be found in the publication "Function Blocks for S5-130 W, SINUMERIK System 3".

11.3.4 Designated Variables for Function Blocks

1. Data blocks

- DB 0 Address lists
- DB 1 Variables for service unit 333
- DB 2 Variables for function blocks
- DB 9 For data exchange PC/NC
- from DB 10*For user variables, e.g. states of control sequences, etc.

2. Flags

Flags 0 through 17 are reserved for the PC/NC interface.
Flags 188 through 255 are reserved for function blocks.

3. Counters

Counter 0 is used for the code conversion BCD/binary.

4. Timers

Timers 0 and 1 are used for function block "Auxiliary functions" data to NC.

5. Function Blocks

Function blocks 0 through 99 are used as standard FBs.

*DW 0 through 9 of the data block must be reserved for parametering of sequences.

11.3.5 Flag List

| Flag Byte | Function | |
|-----------------|--|--|
| 0 8 | Signals PC to NC | For more information consult the interface description for SINUMERIK System 3 |
| 9 11 | Unassigned | |
| 12 17 | Signals NC to PC | |
| 18 187 | | |
| 188 219 | Reserved for individual signals | |
| 220 | | |
| 221 | Turret TC actual position | See FB40 RI-Ausw (Direction selection) |
| 222 | Turret TC command position | |
| 223 224 | Transfer flags for function block DATANNC | See FB22 DATANNC (Data to NC) |
| 225 237 | Output signals for M-function decoding | See FB20 M-DECOD |
| 238 239 | Auxiliary signals | See FB12 HILFSFKT (Auxiliary functions) |
| 240 243 | Reserved for PSP inputs | |
| 244 247 | Status flags | See corresponding function blocks |
| 248 251 | Input flags | |
| 252 255 | Auxiliary flags for scratch pad results | |

11.4 Program Examples

11.4.1 Factory Program

The PC is shipped from the factory with a PC program on the first EPROM on the EPROM memory module of the PC-CPU.

Use: to test the NC functions without a customer PC program.

Setting: The machine control panel cable must be connected to an input board. The strapping must be for the 0-5 input byte, i.e. X1 without jumpers.

Blocks used: the standard function blocks FB11 and FB12, the test block FB200, and one OB1.

EPROM Modules: The modules have the factory designation:

| | | |
|-----------------|-----------|-----------------|
| 548 811 0061 03 | 4k memory | |
| 548 811 0062 03 | 8k memory | |
| | | ↑ _____ edition |

When clearing the factory program to write the user program, a spare module should be used. Such a module may be found in the spare parts case.

Program Construction: 3 different programs can be jumped into by interrogating during PORESET:

1. Program with Axis Lock: At PORESET, the operating mode selector switch should be in "Data Output" position, and the SNS key should be pressed. All keys and switches of the machine control panel (except E-Stop) may be used.

Test of operating modes and programs without axis movement.

2. Program without Axis Lock: At PORESET, set the operating mode selector switch to "Reference Point Approach" and press the Sequence Number Search (SNS) key. All switches and keys (except E-Stop) may be used. Test of operating modes and programs with axis movement. Caution must be used with this program, because the signals E-Stop, Feed, and Control Enable are fixed by the PC program.

3. Program I/O-Simulator. This program is executed when not jumping in either program with or without axis lock. All keys and switches of the machine control panel, except Feed Hold/Start, Spindle ON/OFF and E-Stop, can be used.

Test of operating modes. Axis movement is possible only if the axis enables are connected.

Remark: only the I/O Simulator Program is available with EPROM modules in editions 01 and 02.

11.4.2 Structure of the Factory Program

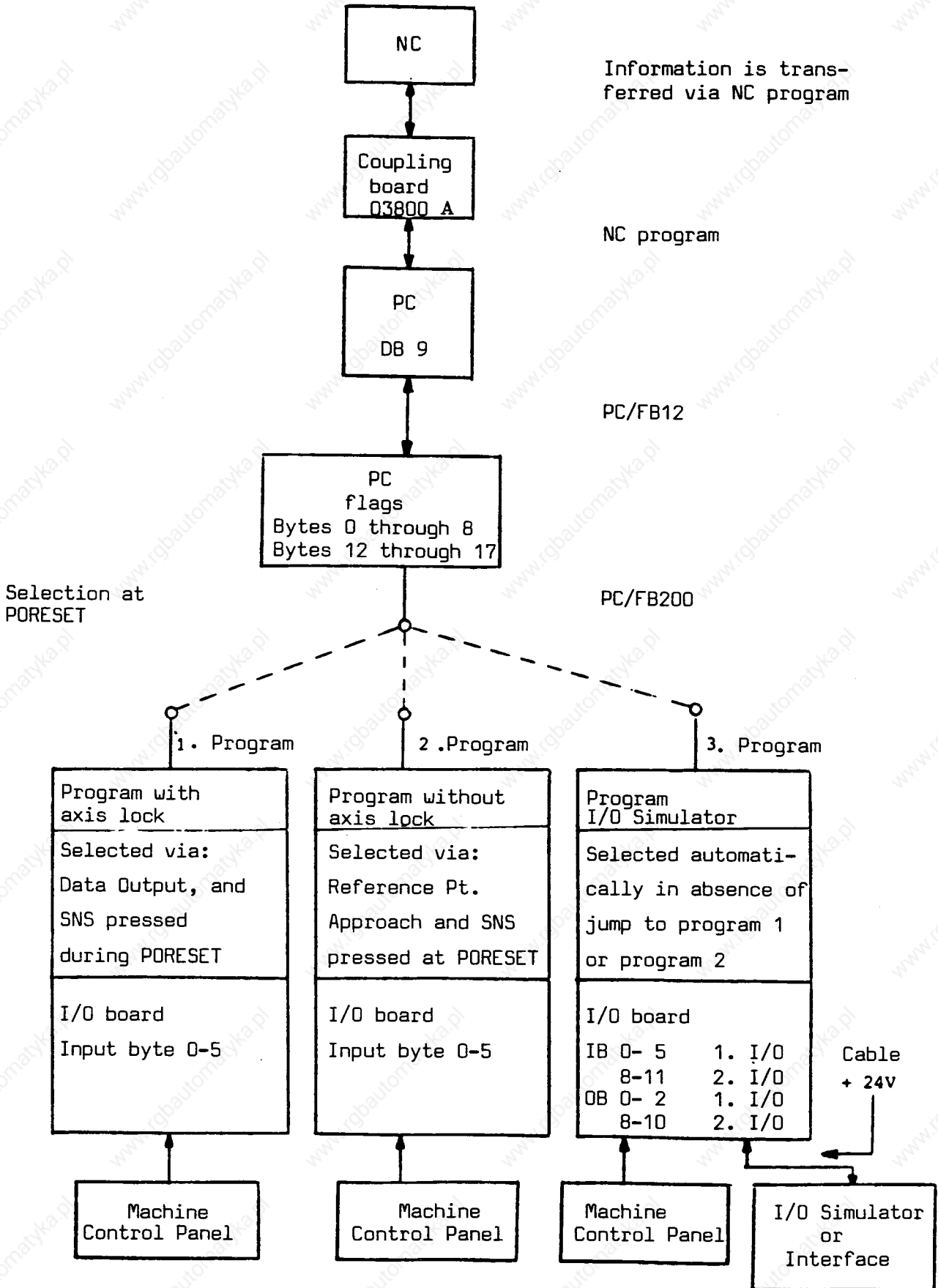

11.4.3 Shipping Program Printout

BLOCK LIST

| BLOCK TYPE | NUMBER | SYMBOL | LENGTH | LIBRARY NUMBER |
|------------|--------|--------|--------|-------------------|
| FB | 11 | | 116 | P71200-B 3111-A-1 |
| FB | 12 | | 206 | P71200-B 3112-A-5 |
| FB | 200 | | 85 | 382 |
| FV | 200 | | 16 | |
| OB | 1 | | 13 | |

711 FREE BLOCKS

OB1



SEGMENT 1 AG150A
0000 :A F239.6
0002 := F251.0
0004 := F251.1
0006 :JU FB12
0008 NAME :AUXILIARY FUNCTION
000A :JU FB200
000C NAME :SERVICE -TE
000E :BE

FB 200

SEGMENT 1

NAME :SERV.-TE

```

000A :UN M 238.1 GST (Reset State)
000C :SPB =PROG
000E :L EWD
0010 :T MW150
0012 :L MB150
0014 :SRW 4
0016 :T MB152
0018 :L MB152
001A :L KH0001 Position 
001E :!=F
0020 :S M 153.0 AF with axis lock
0022 :L MB152
0024 :L KH000E Position 
0028 :!=F
002A :S M 153.1 AF w/o axis lock
002C PROG :U M 151.3 SNS
002E :U M 153.0 AF with axis lock
0030 :SPB =M-A
0032 :U M 151.3 SNS
0034 :U M 153.1 AF w/o axis lock
0036 :SPB =O-A
0038 :L EWD
003A :T MWO
003C :L EW2
003E :T MW2
0040 :L EW4
0042 :T MW4
0044 :L EBB
0046 :T MB6
0048 :L EB9
004A :T MB8
004C :L EB10
004E :T MB7
0050 :L EB11
0052 :T MB9
0054 :L MW12
0056 :T AWO
0058 :L MB15
005A :T AB2
005C :L MB16
005E :T AB8
0060 :L MB17
0062 :T AB9
0064 :L MB14
0066 :T AB10
0068 :SPA =ENDE
    
```

Program with I/O Simulator

MB150

MB151



MB152

MB153

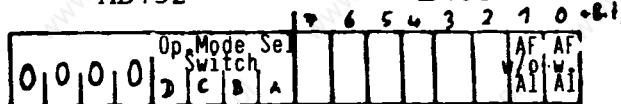

A = Axis lock

```

006A M-A :UN M 5.3
006C :S M 5.3
006E O-A :L EWD
0070 :T MWO
0072 :U E 2.2
0074 := M 2.2
0076 :U E 2.3
0078 := M 2.3
007A :U E 2.4
007C := M 2.4
007E :U E 2.5
0080 := M 2.5
0082 :U E 2.6
0084 := M 2.6
0086 :U E 2.7
0088 := M 2.7
008A :U E 3.2
008C := M 3.2
008E :U E 3.4
0090 :S M 4.2
0092 :UN E 3.5
0094 :R M 4.2
0096 :U E 3.6
0098 :S M 4.3
009A :UN E 3.7
009C :R M 4.3
009E ENDE :BE
    
```

Program w/o axis lock

Program with axis lock

11.4.4 Example of Program Structure with FB12

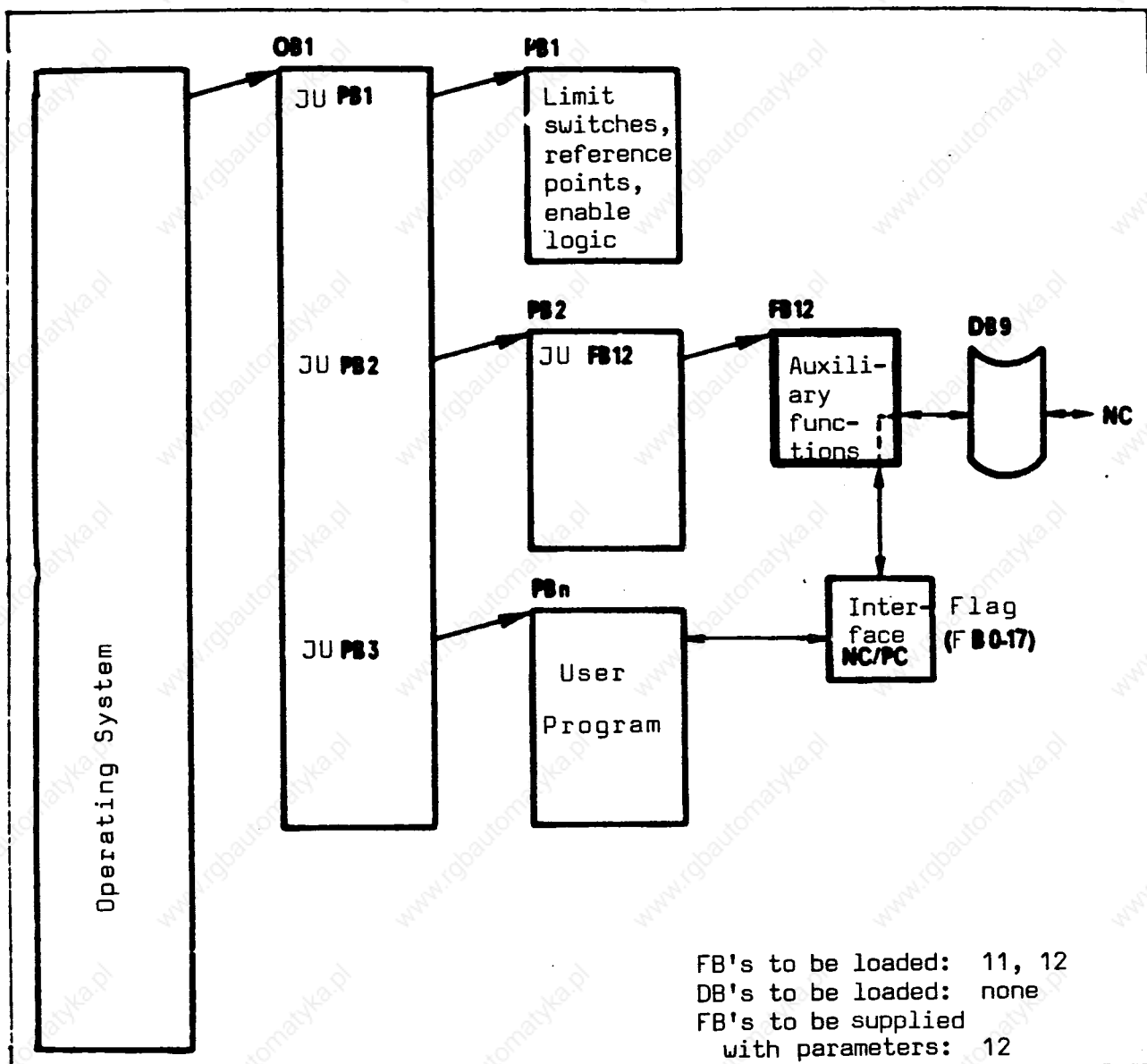

This is an example of a program structure in which only the function block "Auxiliary functions" is used. In the cyclic program (OB1), this function block is called in a program block which follows the PB for axis-specific functions. This sequence is necessary, to ensure the shortest possible response time for the axis-specific signals.

The main task of the "Auxiliary functions" FB, in addition to the start routine, is to interchange the signals to be transferred between NC and PC, between the flag ranges 0-17 and DB9. This transfer achieves the following:

- intermediate results are not transferred to the NC, and
- The logic processing of NC signals is independent of its position within the PC program.

DB9, necessary for the signal exchange, is set up automatically during system start.

11.4.5 Example of NC Oriented Function Blocks

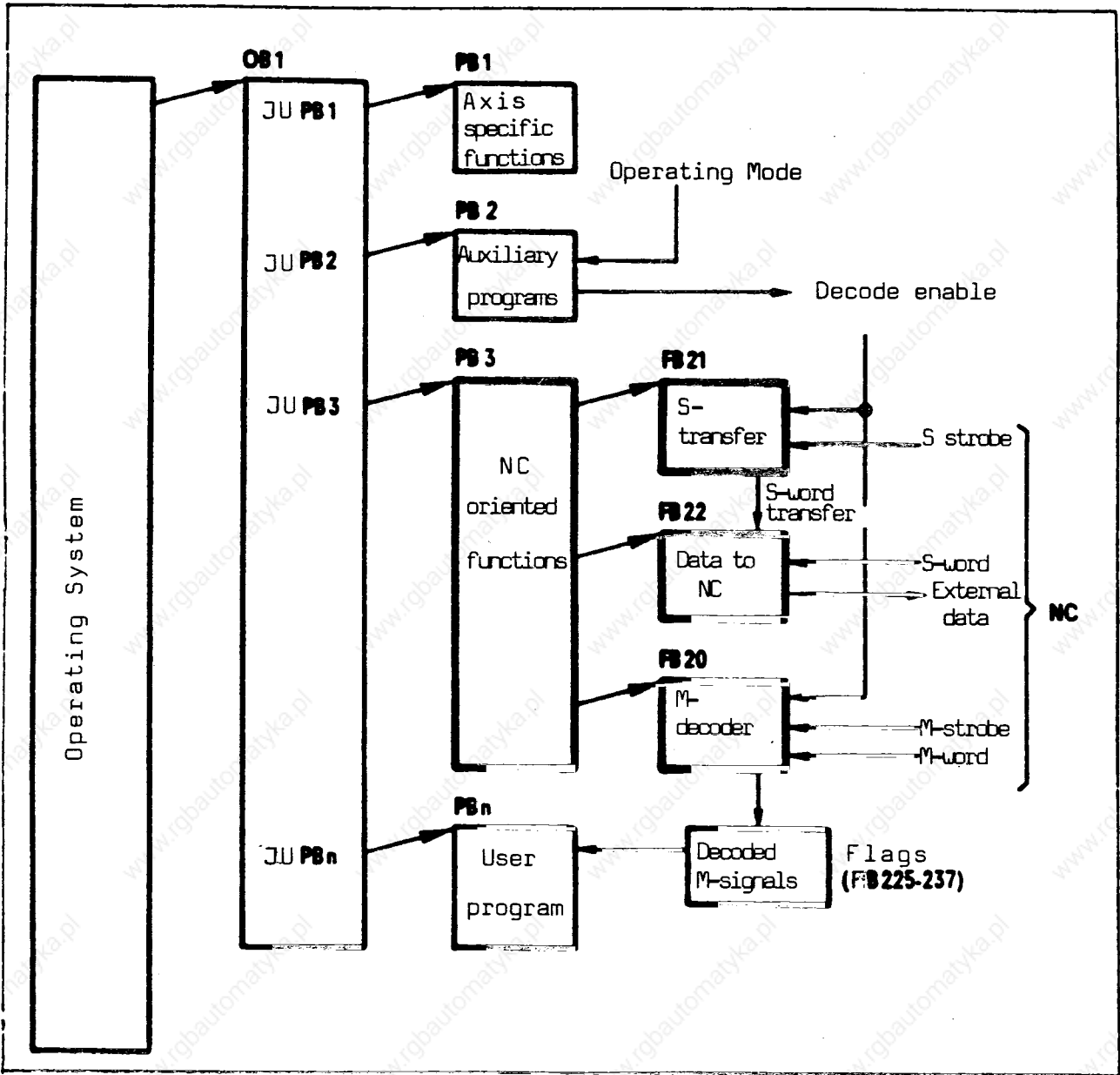

NC oriented function blocks serve to simplify the transfer of data between the NC and the PC.

It is most convenient to combine all the NC oriented function blocks into one program block.

11.5 Test Aids

11.5.1 Input/Output Signal Image on NC CRT

The image of the interface between the PC and machine tool can be displayed any time, under ident. nr. 35 - 54.

Refers only to version 3, starting with software edition 02.

Input is not possible.

| <u>MDI SE-TE</u> | |
|---------------------|---------------------|
| PC INPUT SIGNALS | |
| 35 | 36 |
| B00 11111111 | B10 00000011 |
| B01 11111111 | B11 00000000 |
| B02 11111111 | B12 00000000 |
| B03 11111111 | B13 00000000 |
| B04 11111111 | B14 00000000 |
| B05 11111111 | B15 00000000 |
| B06 11111111 | B16 00000000 |
| B07 11111111 | B17 00000000 |
| B08 00000011 | B18 00000000 |
| B09 10000000 | B19 00000000 |

e.g.

I bytes 0-7 are not used;
machine control panel connected to
I bytes 8-10

| | |
|----------------------|-----------------|
| Ident. nr. 37 and 38 | B20 through B39 |
| " " 39 and 40 | B40 " B59 |
| " " 41 | B60 " B63 |

All 64 input bytes are always displayed.

B00 corresponds to input byte 0, etc.

Input signal 1 (+24 V): Display 1

Input signal 0 : Display 0

Input board not installed: Display 1

MDI SE-TE

PC OUTPUT SIGNALS

| 48 | 49 |
|---------------------|---------------------|
| B00 00000000 | B10 00000000 |
| B01 00000000 | B11 00000000 |
| B02 00000000 | B12 00000000 |
| B03 00000000 | B13 00000000 |
| B04 00000000 | B14 00000000 |
| B05 00000000 | B15 00000000 |
| B06 00000000 | B16 00000000 |
| B07 00000000 | B17 00000000 |
| B08 00000000 | B18 00000000 |
| B09 00000000 | B19 00000000 |

Ident. nr. 50 and 51 B20 through B39
 " " 52 and 53 B40 " B59
 " " 54 B60 " B63

All 64 output bytes are always displayed.

B00 corresponds to output byte 0, etc.

Output signal 1: Display 1

Output signal 0: Display 0

Output board not installed: Display 0

11.5.2 PC Program Correction via NC (see section 12)

11.5.3 Access to PC via NC Engineering Panel (see section 10)

11.5.4 Service Unit 333-OBA

11.5.4.1 Application area

Service unit 333 is a testing aid for the PC SIMATIC S5-130 W.

All the signal states of the device and program can be interrogated and changed rapidly with the help of this unit.

The service unit can furthermore, remain permanently connected to the PC, and be used for fast location of problems.

The following functions can be executed:

- Data output, time and counter values
- Data input, time and counter values through data words
- Signal state display of inputs, outputs, flags (bit, byte, wordwise)

The service unit is connected to the PC ~~through~~ digital inputs and outputs.

The user program of the PC cannot be changed through the service unit, even if improperly operated.

11.5.4.2 Construction

The service unit consists of a plastic housing with operating and display elements on the front side. The two connecting cables (approximately 3 m long) exit at the bottom, and have a 48 pole connector, construction form F.

The service unit is provided with magnets, which allow it to be mounted on metal cabinets.

11.5.4.3 I/O Board

An S5 I/O board, e.g. 6ES5-482, with 16 inputs and 16 outputs must be used. This board is plugged into the location of the PG interface or that of an I/O board, and can be removed again during normal operation. The address selected in the program must be strapped properly on the addressing socket of the board.

11.5.4.4 Program Structure

Program and Data Structure with Service Unit 333-OBA



1) FB 36 should be called if no user program is available.

FB 35 has to be parametrized by a program block, and must be called cyclically.

11.5.4.5 Program Example

for use with FB200, according to section 10.3.3

Address 32 of the I/O board is called in PB2. On board 482, pins 3-14, on strapping socket X1, must be jumpered.

BLOCK LIST

| BLOCK TYPE | NUMBER | SYMBOL | LENGTH | LIBRARY NUMBER |
|------------|--------|--------|--------|-------------------|
| DB | 35 | | 64 | 3500 |
| DB | 2 | | 10 | |
| DV | 35 | | 14 | |
| FB | 11 | | 116 | P71200-B 3111-A-1 |
| FB | 12 | | 206 | P71200-B 3112-A-4 |
| FB | 16 | | 78 | P71200-B 3116-A-0 |
| FB | 35 | | 464 | P71200-B 3135-A-1 |
| FB | 36 | | 19 | P71200-B 3136-A-0 |
| FB | 200 | | 85 | 382 |
| FV | 200 | | 16 | |
| OB | 1 | | 16 | |

697 FREE BLOCKS

| OB1 | AG150A | PB2 | AG150A |
|-----------|----------------|-----------|-----------|
| LEN =16 | ABS | LEN =10 | ABS |
| SEGMENT 1 | | SEGMENT 1 | |
| 0000 | :A F 239.6 | 0000 | :L KB32 |
| 0002 | := F 251.0 | 0002 | :T F 255 |
| 0004 | := F 251.1 | 0004 | :JU FB35 |
| 0006 | : JU FB12 | 0006 NAME | :SER 130W |
| 0008 NAME | :AUX. FUNCTION | 0008 | :BE |
| 000A | : JU FB200 | | |
| 000C NAME | :SERV. UNITS | | |
| 000E | : JU PB2 | | |
| 0010 | : JU FB36 | | |
| 0012 NAME | :DELAY | | |
| 0014 | :BE | | |

11.5.5 Service Unit 333 C

Service unit 333 C replaces the previously used unit 333-OBA. Certain functions have been extended in the new unit.

Functions

- Data output, time and counter values
- Data input, time and counter values through data words
- Signal state display of inputs, outputs, flags (bit, byte or word-wise)
- Correction of program and step blocks

Construction :

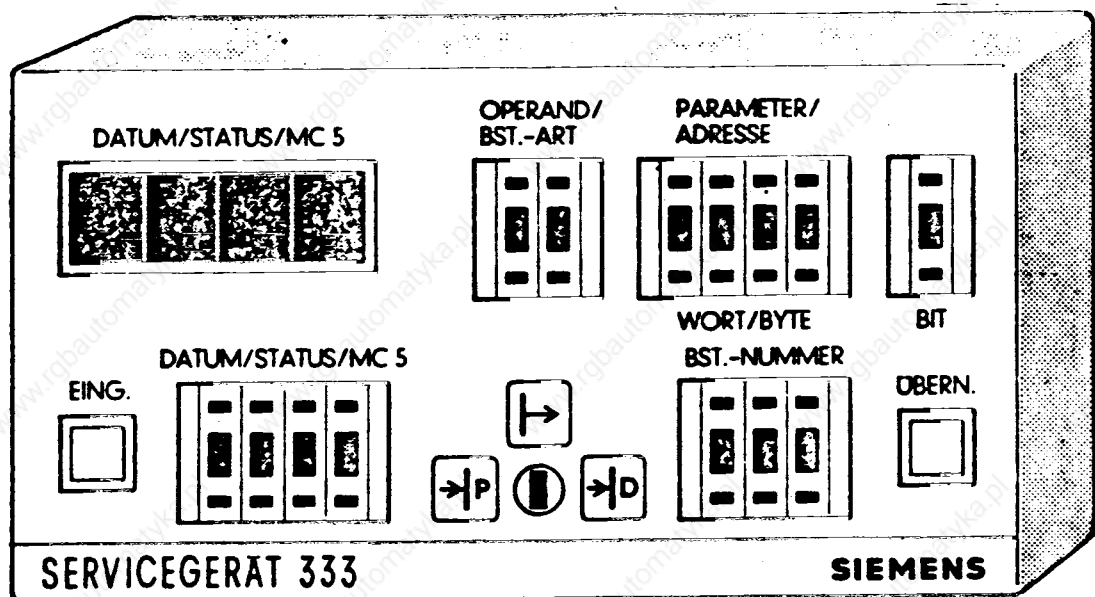

Remark : Currently, service unit 333 on the S5-130W does not function with FB 25.

11.5.6 PG 670/PG 675

For functions and handling, see the training manual for S5-130W and the operating instructions PG 670/675.

3 CONTROL BITS IN SYSTEM DATA WORD BS7: (SD7)

These displays give additional information about interrupt cause and the procedure for restart.

4 INFORMATION ABOUT INTERRUPT POSITION (ERROR LOCATION);

5 CPU STATE:

Includes contents of accumulators 1 and 2,
and the result displays for binary and digital operations whose execution was interrupted with the STOP-STATE.

6 INTERRUPT CAUSE (IN THE ISTACK):

This line shows the user the first information concerning the cause of an interrupt of cyclic processing. The cause displayed is the determining factor for the further course of the procedure of subsequent diagnosis.

The control bits in the system words have the following meanings :

1 CONTROL BITS IN SYSTEM DATA WORD BS5 (SD5)

PBSSCH not used
 BSTSCH The function "Compress memory content" (COMP:PC) has not been finished. After the cyclic operation is resumed (green LED lit), reactivate function "Compress memory content" at the PC.
 SCHTAE Block gap in the user program. Restart is possible only after PC cleared with restart.
 ADRBAU Block address is not yet generated/activated.
 SPABBR Function "Compress memory content" has been interrupted through a power failure or PC stop.
 NAUAS Designation for "Power failure" for the programming unit interface;

QUITT Not used

2 CONTROL BITS IN SYSTEM DATA WORD BS6: (SD6)

STOZUS } STOP designations. STOZUS indicates that the PC is in stop state
 STOANZ } STOANZ indicates that the PC is in stop state.
 NEUSTA NEW START: cyclic operation is possible only with restart.
 WIEDAN* Restart interrupted.
 BATPUF CPU contains a buffer battery for RAM memory.
 BARB } State display for operation modes.
 BARBEND } "Processing control" with PG.

UAFEHL Interrupt stack is being processed without prior input.

MAFEHL Collective signal for displays in system data word BS7.

EOVH PC contains input byte 0 (alarm processing).

3 CONTROL BITS IN SYSTEM DATA WORD BS7: (SD7)

ASPNPR Indicates that the user memory connected additionally consists only of EPROMs.

ASPNRA Indicates that the user memory only consists of RAM. In principle, the user has available a RAM capacity of about 5.8 kbytes** in the CPU. The PC is hence operational even without any additional user memory.

KOPFNI Indicates that the block type was not recognized during address list generation.
The PC is not operational when this flag is set. The program sequence hence branches into the stop-loop.
Remedy: initial clear of the PC.

PROEND not used

PADRFE Indicates that the user PROM memory is incorrectly addressed. The PC is not functional when this flag is set. The program branches into the micro programmed stop-loop.
Remedy: New addressing of the EPROM modules following the proper guidelines.

ASPLUE Indicates that the user memory is being addressed with gaps. The flag is set in combination with flag "PADRFE" or "RADRFE". The PC is not operational when the flag is set; the program branches into the stop-loop.
Remedy: Readdressing the user memory.

RAMADFE Indicates that the user RAM memory is incorrectly addressed. The PC is not operational when the flag is set; the program sequence branches into the micro programmed stop-loop.
Remedy: Readdressing the user RAM memory following guidelines.

KEINAS Indicates that, up to 48 K, no additional user memory is connected, respectively addressed. This means, that the PC is assembled with only the user memory on the CPU.

SYNFEH Indicates that there is no synchronization pattern (inadmissible code) on certain locations in the user memory. Blocks cannot be found when the memory content is undefined; the program sequence branches into the stop-loop.
Remedy: Initial clear.

** only 1 kbyte in the case of 130 WA

NINEU a) Indicates that a new start cannot be executed. It is always set in conjunction with a more specific error indication. The exact reason for the restart interrupt can be gathered from the additional error indications.
Remedy: Initial clear.

b) Restart could not be executed; the cause was eliminated in the mean time.

NIWIED* Restart no longer possible. Execute newstart.

EAFEHL** I/O board fault or EU couple defect or peripheral configuration changed.
Remedy: Exchange defective board and/or initial clear/load.

SUMF A sum error has been recognized within the system program memory or the user program. If the sum fault is still recognized after initial clear and newstart, exchange the system program memory, reload the user program.

URLAD Indicates that cyclic operation is possible only after initial clear with initial load, and finally newstart. The initial loading process is executed by the programming unit interface in the range of 0 through 64 kbytes. Afterwards, all RAM memory cells contain 0000H.

4 INFORMATION ABOUT INTERRUPT LOCATION (ERROR LOCATION)

TIEFE no meaning

BEF-REG MC-5-code of the last processed instruction. In most cases, this is the false instruction in programming errors.

BST-STP This is the memory cell in which the last entry was made, in the block stack (BSTACK). The display is without meaning. Display the BSTACK if necessary.

SAZ Address of the memory cell which contained the next instruction to be processed, at the time when the stop-state occurred. In case of "NNN" error, SAZ contains the address of the instruction where the error occurred. The contents of the memory cell can be read with "Output addr:PC,"SAZ"!" in MC-5-code. The error location can be found easier with "Block nr." and "REL-SAZ".

"BST"-NR Display of block OB-PB-FB, processed before the stop-state. In programming errors, the location of the fault must be found in this block with "OUTPUT PC,"BST-NR."".

REL-SAZ Relative address in given block. When the key-switch "Input lock" is turned to the right, the relative block addresses can also be displayed on the CRT of PG . The relative address corresponds to the absolute "SAZ" address. The faulty address is directly in front of the relative address

DB-ADR } Start address and number of the data block last called in the
DB-NR. }

5 STATE OF THE CPU

AKKU 1 Content of
AKKU 2 both accumulators

Result Display Bits:

ANZO Display bits 1 and 0 with 2-3 meanings, depending on the type of logic operations (e.g. logic result, comparison result, bit-test result for shift operations).

OVFL Overflow; for cases where the numerical range was exceeded in a just executed arithmetic operation.

CARRY Carry-over between the two bytes of the CPU.

ODER OR-memory. When in a previous OR operation, the RLO was =1.

STATUS Signal state of the last processed operands.

VKE (RLO) Logic result of the instruction last processed.

ERAB The instruction last processed was a first instruction (= beginning of new logic).

6 INTERRUPT CAUSE (IN ISTACK):

The causes of the faults have the following meanings:

STOPS The stop-switch is on.

NNN Syntax error
The user programmed inadmissible operations (e.g. access to data blocks with instruction parameter data block length), or operations which exceed the instruction set of the PC S5-130W.

STS a) Stop-request from the user
Through operation STP, the user has the option of requesting from the system software, that the PC branch into stop-loop at the end of the running cycle. The branching itself occurs through the stop-instruction of the system software STS.

STUEB b) Block stack overflow
*)
The continuation address of the block called is stored in the block stack, each time a block is called. When the block stack overflows, PC goes into the stop-loop.

NAU Power failure
If, when the power returns, the operating mode selector switch is in the OPERATION position, there is an automatic newstart of the PC, respectively a restart, if the OB22 is present.

*) b) **General PC system error: Further info can be gathered from the control bits of system data BS5/BS6, e. g. addressing of boards wrong etc.**

QVZ: Acknowledge Delay

If an addressable range does not acknowledge its addressing within a monitored time interval, an acknowledge delay is issued. Two possibilities for acknowledge delay exist, depending on the addressed range:

- Acknowledge delay at memory access
- Acknowledge delay at periphery access

ZYK: Cycle Time Exceeded

If the cycle time is exceeded, the STEP-5 program is interrupted. The PC goes into STOP. This can happen due to false programming (program execution time too long).

Fixed cycle times: 130 WA...270 ms
130 WB...360 ms

BAU: Battery Voltage Failure

The signal Battery Voltage Failure is generated by a monitoring circuit in the power supply unit. This signal is recognized by the PC at newstarts; the program sequence branches into the stop-loop. If power failure occurs during battery voltage loss, the contents of the RAM memory are lost. The user must initial clear and initial load the PC. The battery can be exchanged during cyclic operations, without interruption.

Remark: The control bits and the ISTACK can be displayed on the NC CRT with the PC program structure, according to section 12. Control bits SD5, 6, 7, and 214 can also be read with the NC engineering panel (see section 10 and 11.8.4).

11.6.2 Block Stack (BSTACK)

In the BLOCK STACK of the PC S5-130W, during the execution of the program, each time a block is left, two informations are written:

1. The start address of the data block valid before the block was left
2. The number of the memory address from which the program execution must be continued, after returning from the called blocks (return address)

The information written in the block stack can be read with the PG 670/675 or with the PC program correction in the STOP-STATE of PC S5-130W (OUTPUT BSTACK!).

11.8 PC Lists

11.8.1 Memory Map PC 130 WA



11.8.2 Address List PC 130 WA

NC- PC-
Adr. Adr.

Address List Format

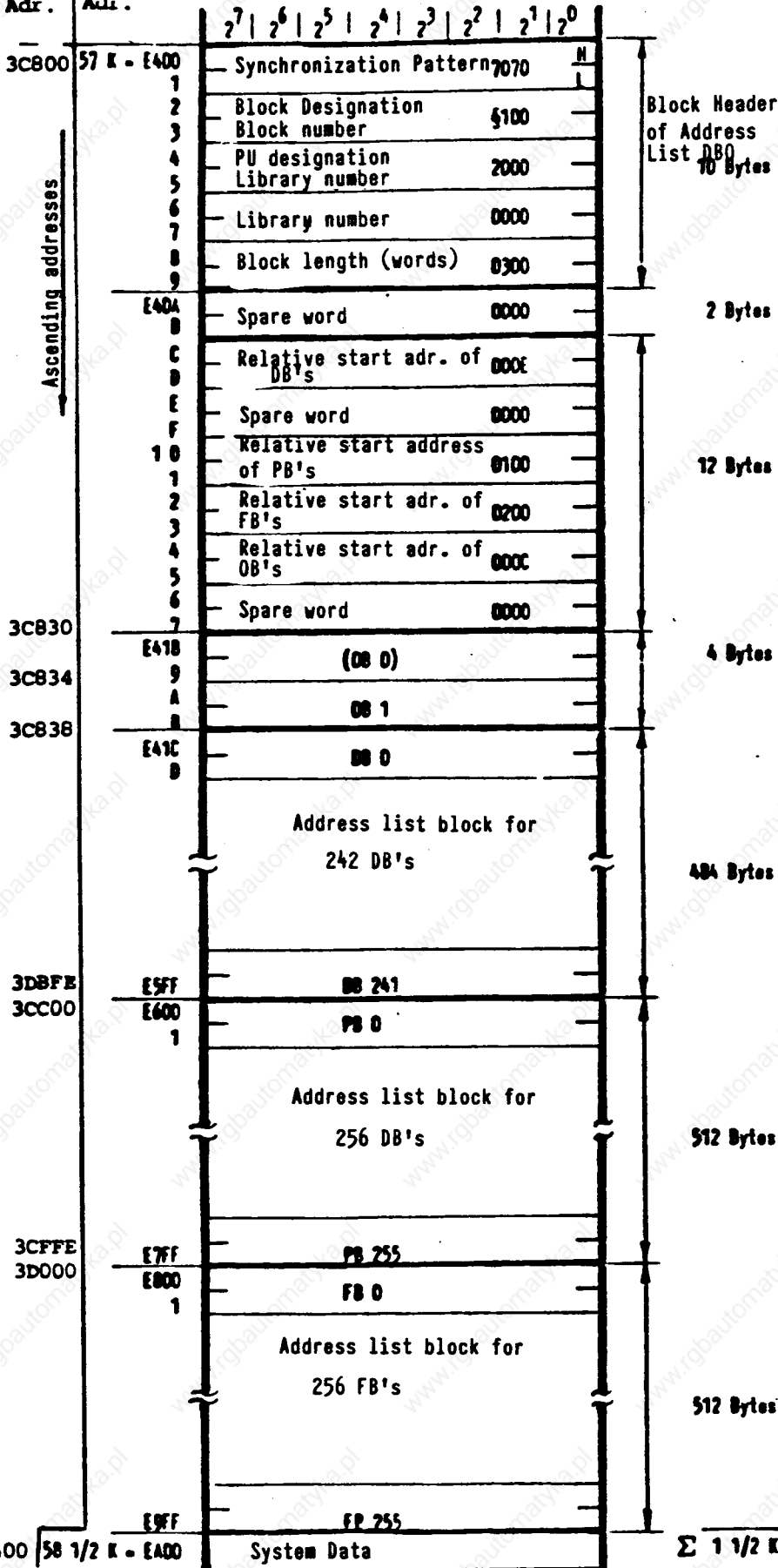

Absolute Start Address of Address List Blocks

DB's E41C
PB's E600
FB's E800
OB's E418

Relative Start Address of Address List Blocks

(Distance in word from the header address of address list)

DB's 000E
PB's 0100
FB's 0200
OB's 000C

Distance Address of the Address List Blocks

(Distance in bytes from the start address of DB 0)

DB's 0012
PB's 01F6
FB's 03F6
OB's 000E

Length of the Address List Blocks in Bytes

DB's 01E4
PB's 0200
FB's 0200
OB's 0004

Header Address of the Address List

E400

Absolute Start Address of the Address List

E40A

Length of Address List

in bytes: 0600
in words: 0300

Internal RAM Memory Map for: 130 WA and 130 WB

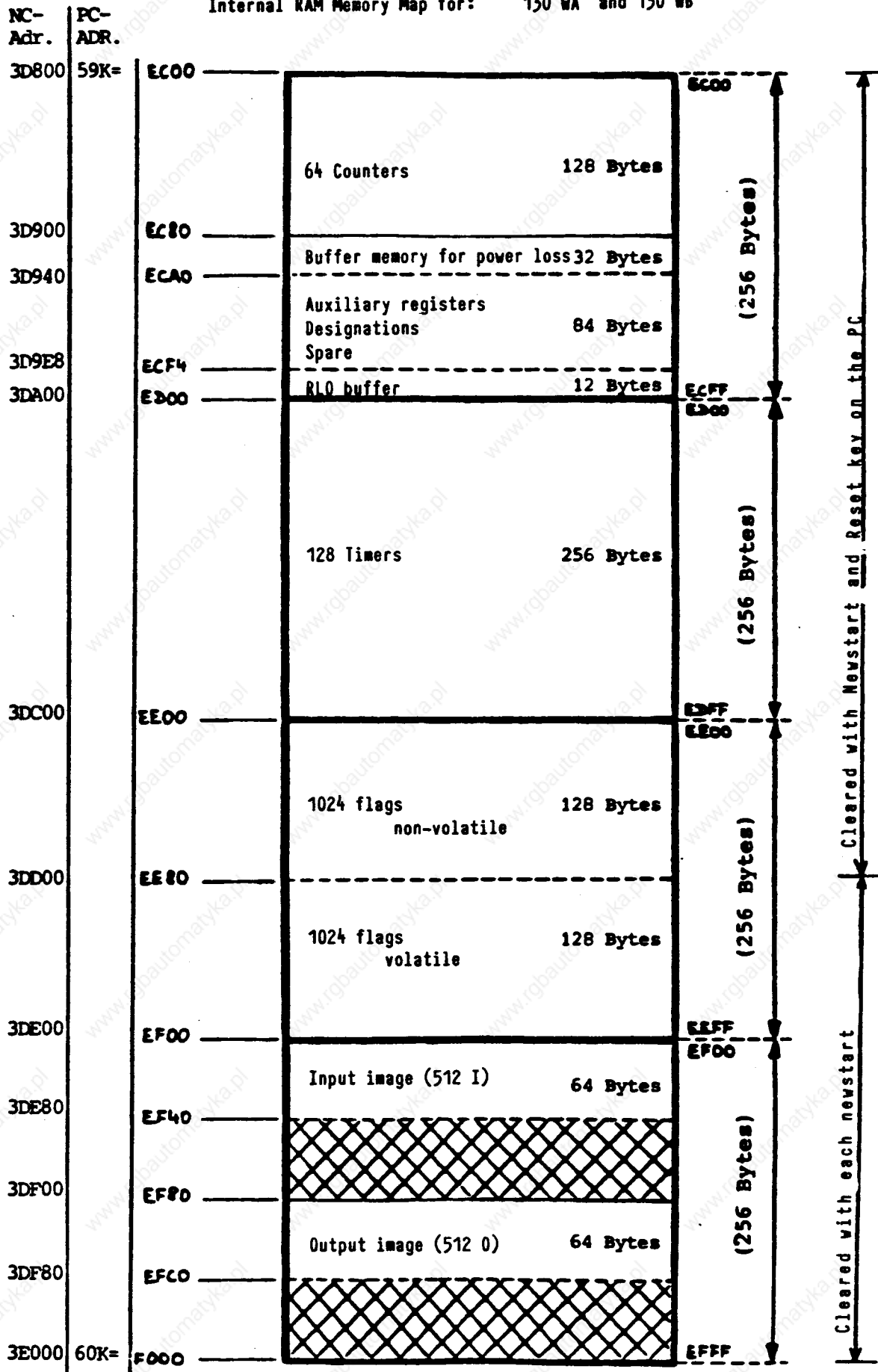

11.8.4 System Range for Error Localization for 130 WA and 130 WB

| | | SD: System data word address 3D400 ... 3D41E: NC address | | | | | | | | PC Address |
|----------------|-------------|---|-------------|-------------|----------------|--------------|------------|------------|---|--------------------------------|
| | | 7 | 6 | 5 | 4 | 3 | 2 | 1 | 0 | |
| SD 5 3D414 | X | PBSTSCH | BSTSCH | SCHTAET | ADRBAU | SPABBR | NAUAS | QUITT | | E AOA # |
| | X | X | X | X | X | X | X | X | X | B |
| SD 6 3D418 | STOP STATE | STOP DISPLAY | NEW - START | RESTART | BATTERY BUFFER | X | BARB | BARB END | | C |
| | X | UAFEHL | MAFEHL | EOVH | X | X | X | X | | D |
| SD 7 3D41C | ASP NURPROM | ASP NURPAM | KOPF NINT | PROMSCH END | X | PROM ADRFEHL | ASP LUECKE | RAM ADFEHL | | E |
| 3D41E | 56KKEIN ASP | SYNCHR FEHL | NINEU | NIWIED | X | EAFEHL | SUMPF | UPLADEN | | E AOF |
| SD213 3D754 | 0 | 0 | 0 | 0 | 0 | 0 | 0 | 0 | | E BAA # |
| | ANZ1 | ANZ0 | OVER FLOW | CARRY | OR | STATUS | VKE | ERAB | | B |
| SD214 3D758 | STOP SWITCH | X | X | X | NNN | STS | STUEB | X | | C } Interrupt display word IDW |
| 3D75A | NAU | QVZ | X | ZYK | X | X | BAU | X | | D |

* only 130 WB

X: No meaning (not used currently)

#: SD is buffered; all others are cleared with each newstart.

11.3.5 Memory Map 130 WB

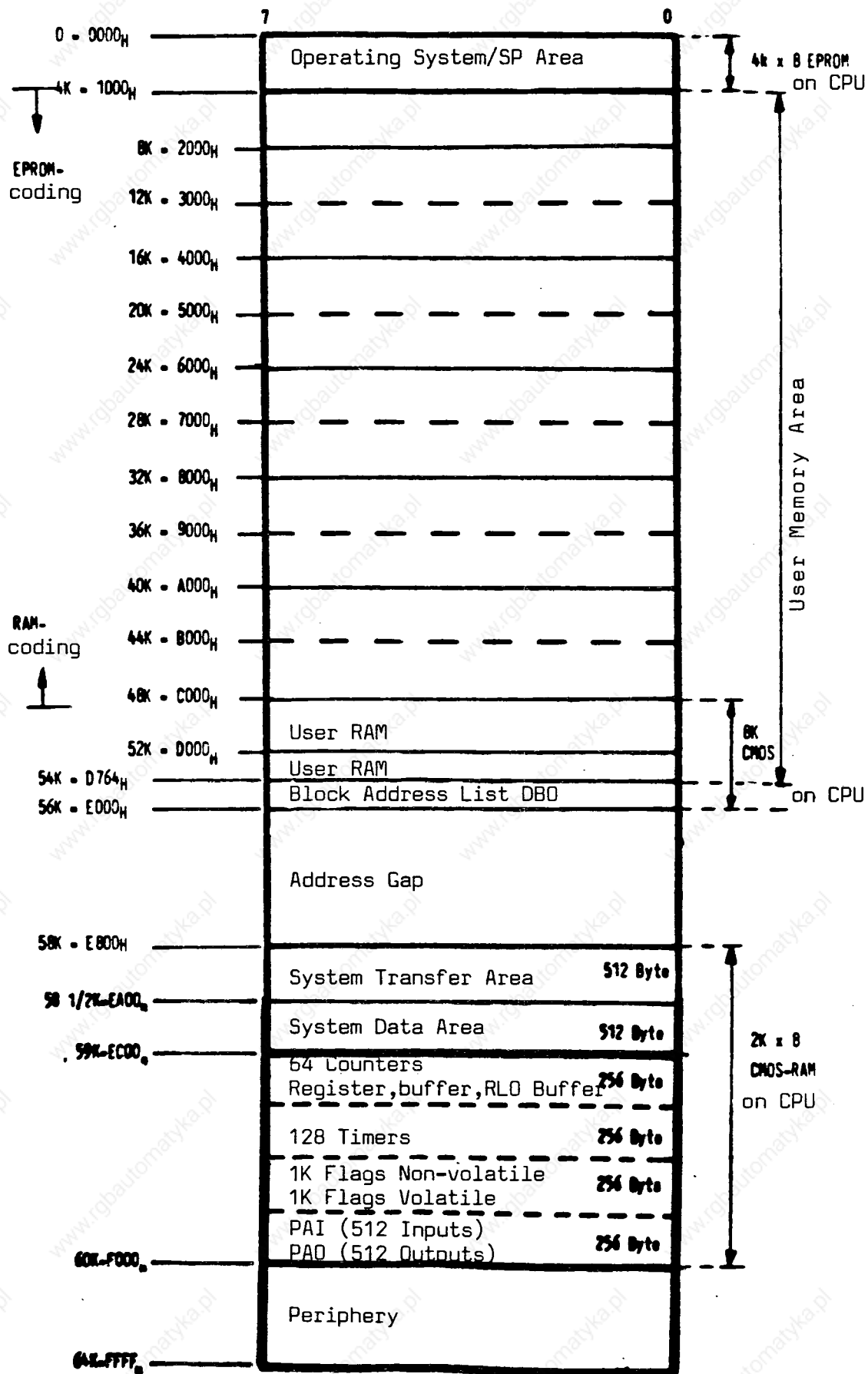

11.6.6 Address List PC 130WB

PC-Adr.

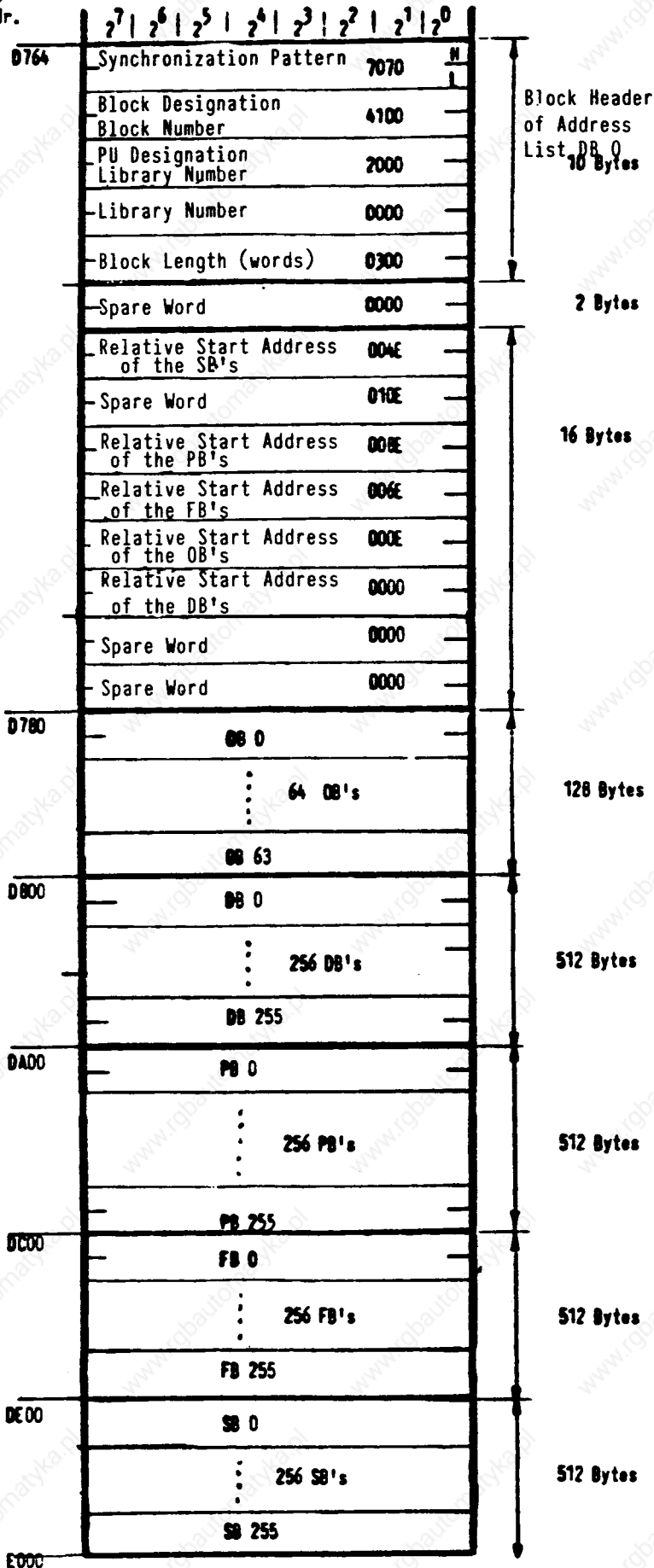

Address List Format

Absolute Start Address of Address List Blocks

| | |
|------|------|
| DB's | D800 |
| PB's | DA00 |
| FB's | DC00 |
| OB's | D780 |
| SB's | DE00 |

Relative Start Address of Address List Blocks

(Distance in words from the header address of the address list)

| | |
|------|------|
| DB's | 004E |
| PB's | 008E |
| FB's | 00CE |
| OB's | 000E |
| SB's | 010E |

Distance Address of the Address List Blocks

(Distance in bytes from the start address of DB 0)

| | |
|------|------|
| DB's | 006A |
| PB's | 00AA |
| FB's | 00EA |
| OB's | 002A |
| SB's | 012A |

Length of the Address List Blocks in Bytes

| | |
|------|------|
| DB's | 0200 |
| PB's | 0200 |
| FB's | 0200 |
| OB's | 0080 |
| SB's | 0200 |

Header Address of the Address List

D764

Absolute Start Address of the Address List

D76E

Length of Address List

| | |
|-----------|------|
| In bytes: | 089C |
| In words: | 044E |

Instruction Set 130 WA

| Operation | Parameter | Cycle time (μs) | Operation code | | Condition codes | | Function | | |
|--------------------------------|-----------|-----------------|----------------|-----------|-----------------|--------|-----------|---|------------------------------|
| | | | Byte 0 | Byte 1 | RLO | FIB | | | |
| Binary logic operations | | | | | | | | | |
| | | | | Bit addr. | Byte addr. | | AND logic | | |
| A | I | 0,0 to 127.7* | 3.75 | C 1100 | 0 0100 | 0 0100 | 0 1000 | X | Scan input for *1* |
| A | Q | 0,0 to 127.7* | 3.25 | C 1100 | 0 0100 | 0 1100 | 0 1000 | X | Scan output for *1* |
| A | F | 0,0 to 255.7* | 3.25 | 0 1000 | 0 0100 | 0 1000 | 0 1000 | X | Scan flag for *1* |
| AN | I | 0,0 to 127.7* | 3.25 | E 1110 | 0 0100 | 0 0100 | 0 1000 | X | Scan input for *0* |
| AN | Q | 0,0 to 127.7* | 3.25 | E 1110 | 0 0100 | 0 1100 | 0 1000 | X | Scan output for *0* |
| AN | F | 0,0 to 255.7 | 3.25 | A 1010 | 0 0100 | 0 1000 | 0 1000 | X | Scan flag for *0* |
| | | | | Bit addr. | Byte addr. | | | | OR logic |
| O | I | 0,0 to 127.7* | 3.25 | C 1100 | 0 1100 | 0 0100 | 0 1000 | X | Scan input for *1* |
| O | Q | 0,0 to 127.7* | 3.25 | C 1100 | 0 1100 | 0 1100 | 0 1000 | X | Scan output for *1* |
| O | F | 0,0 to 255.7 | 3.25 | 0 1000 | 0 1100 | 0 1000 | 0 1000 | X | Scan flag for *1* |
| ON | I | 0,0 to 127.7* | 3.25 | E 1110 | 0 1100 | 0 0100 | 0 1000 | X | Scan input for *0* |
| ON | Q | 0,0 to 127.7* | 3.25 | E 1110 | 0 1100 | 0 1100 | 0 1000 | X | Scan output for *0* |
| ON | F | 0,0 to 255.7 | 3.25 | A 1010 | 0 1100 | 0 1000 | 0 1000 | X | Scan flag for *0* |
| | | | | | Word addr. | | | | AND logic |
| A | T | 0 to 127 | 3.25 | F 1111 | 0 1000 | 0 1000 | 0 1000 | X | Scan timer for *1* |
| AN | T | 0 to 127 | 3.25 | F 1111 | C 1100 | 0 1000 | 0 1000 | X | Scan timer for *0* |
| A | C | 0 to 63 | 3.25 | 0 1011 | 0 1000 | 0 1000 | 0 1000 | X | Scan counter for contents >0 |
| AN | C | 0 to 63 | 3.25 | 0 1011 | C 1100 | 0 1000 | 0 1000 | X | Scan counter for contents =0 |
| | | | | | Word addr. | | | | OR logic |
| O | T | 0 to 127 | 3.25 | F 1111 | 0 1001 | 0 1000 | 0 1000 | X | Scan timer for *1* |
| ON | T | 0 to 127 | 3.25 | F 1111 | D 1101 | 0 1000 | 0 1000 | X | Scan timer for *0* |
| O | C | 0 to 63 | 3.5 | 0 1011 | 0 1001 | 0 1000 | 0 1000 | X | Scan counter for contents >0 |
| ON | C | 0 to 63 | 3.5 | 0 1011 | D 1101 | 0 1000 | 0 1000 | X | Scan counter for contents =0 |

* The input and output bits (bytes, words) 64,0-127.7 (64-127, 64-126) can be used as additional flag bits (bytes, words). They are loaded (transferred) from the system program and not from (to) the peripheral modules.

| Operation | Parameter | Cycle time (µs) | Operation code | | Condition codes | | Function | |
|--------------|-----------|-----------------|----------------|-----------|-----------------|--------|----------|-------------------------------------|
| | | | Byte 0 | Byte 1 | RLO | FIB | | |
| AND/OR logic | | | | | | | | |
| O | — | 3.25 | F 1111 | B 1011 | 0 — | 0 — | X | ORing of AND functions |
| O(| — | 4.5 | B 1011 | B 1011 | 0 — | 0 — | X | ORing of parenthesised expressions |
| A(| — | 4.5 | B 1011 | A 1010 | 0 — | 0 — | X | ANDing of parenthesised expressions |
|) | — | 3.75 | B 1011 | F 1111 | 0 — | 0 — | X | Right parenthesis |

| Setting/resetting operations | | | Bit addr. | Byte addr. | | | | | |
|------------------------------|---|--------------|-----------|------------|-----------|-----------|-----------|---|---------------------------------|
| S | I | 0.0 to 63.7 | 3.75 | D 1101 | 0 1000 | 0 0000 | 0 X000 | X | Set input to "1" |
| S | Q | 0.0 to 63.7 | 4.5 | D 1101 | 0 0000 | B 1000 | 0 X000 | X | Set output to "1" |
| S | F | 0.0 to 255.7 | 3.5 | B 1001 | 0 0000 | 0 X000 | 0 X000 | X | Set flag to "1" |
| R | I | 0.0 to 63.7 | 3.75 | F 1111 | 0 0000 | 0 0000 | 0 X000 | X | Set input to "0" |
| R | Q | 0.0 to 63.7 | 4.5 | F 1111 | 0 0000 | B 1000 | 0 X000 | X | Set output to "0" |
| R | F | 0.0 to 255.7 | 3.5 | B 1011 | 0 0000 | 0 X000 | 0 X000 | X | Set flag to "0" |
| - | I | 0.0 to 63.7 | 3.75 | D 1101 | B 1000 | 0 0000 | 0 X000 | X | Set input to "1" conditionally |
| - | Q | 0.0 to 63.7 | 4.5 | D 1101 | B 1000 | B 1000 | 0 X000 | X | Set output to "1" conditionally |
| - | F | 0.0 to 255.7 | 3.5 | B 1001 | B 1000 | 0 X000 | 0 X000 | X | Set flag to "1" conditionally |

| Timer and counter operations | | | | Word addr. | | | | | | |
|------------------------------|---|----------|-------|------------|-----------|-----------|-----------|---|--|--------------------------------|
| SP | T | 0 to 127 | 38.0 | 3 0011 | 4 0100 | 0 X000 | 0 X000 | X | | Start timer as pulse |
| SE | T | 0 to 127 | 38.5 | 1 0001 | C 1100 | 0 X000 | 0 X000 | X | | Start timer as extended pulse |
| SR | T | 0 to 127 | 38.5 | 2 0010 | 4 0100 | 0 X000 | 0 X000 | X | | Start timer as ON delay |
| SS | T | 0 to 127 | 38.5 | 2 0010 | C 1100 | 0 X000 | 0 X000 | X | | Start timer as stored ON delay |
| SF | T | 0 to 127 | 38.25 | 1 0001 | 4 0100 | 0 X000 | 0 X000 | X | | Start timer as OFF delay |
| R | T | 0 to 63 | 6.5 | 3 0011 | C 1100 | 0 X000 | 0 X000 | X | | Reset timer |
| S | C | 0 to 63 | 42.75 | 5 0101 | C 1100 | 0 X000 | 0 X000 | X | | Set counter |
| R | C | 0 to 63 | 6.25 | 7 0111 | C 1100 | 0 X000 | 0 X000 | X | | Reset counter |
| CU | C | 0 to 63 | 11.0 | 6 0110 | C 1100 | 0 X000 | 0 X000 | X | | Count up |
| CD | C | 0 to 63 | 9.75 | 5 0101 | 4 0100 | 0 X000 | 0 X000 | X | | Count down |

| Operation | Parameter | Cycle time (μs) | Operation code | | Condition codes | | Function | |
|------------------------------------|-----------|-----------------|----------------|--------|-----------------|--------|----------|---|
| | | | Byte 0 | Byte 1 | RLO | FIB | | |
| Load and transfer functions | | | | | | | | |
| L | IB | 0 to 127° | 3.25 | 4 0100 | A 1010 | 0 000X | 0 X00X | Load input byte of process input image into accu 1 |
| L | IW | 0 to 126° | 4.75 | 5 0101 | 2 0010 | 0 000X | 0 X00X | Load input word of process input image into accu 1 |
| L | QB | 0 to 127° | 3.75 | 4 0100 | A 1010 | 8 100X | 0 X00X | Load output byte of process output image into accu 1 |
| L | QW | 0 to 126° | 4.75 | 5 0101 | 2 0010 | 8 100X | 0 X00X | Load output word of process output image into accu 1 |
| L | FB | 0 to 255 | 4.0 | 0 0000 | A 1010 | 0 X00X | 0 X00X | Load flag byte into accu 1 |
| L | FW | 0 to 254 | 5.0 | 1 0001 | 2 0010 | 0 X00X | 0 X00X | Load flag word into accu 1 |
| L | DR | 0 to 255 | 25.75 | 2 0010 | A 1010 | 0 X00X | 0 X00X | Load right-hand byte of current data block into accu 1 |
| L | DL | 0 to 255 | 24.75 | 2 0010 | 2 0010 | 0 X00X | 0 X00X | Load left-hand byte of current data block into accu 1 |
| L | DW | 0 to 255 | 26.75 | 3 0011 | 2 0010 | 0 X00X | 0 X00X | Load word of current actual data block into accu 1 |
| L | T | 0 to 127 | 5.5 | 0 0000 | 2 0010 | 0 X00X | 0 X00X | Load time (binary) of timer into accu 1 |
| L | C | 0 to 63 | 5.5 | 4 0100 | 2 0010 | 0 X00X | 0 X00X | Load count (binary) of counter into accu 1 |
| L | PB | 0 to 127 | 10.0 | 7 0111 | 2 0010 | 0 X00X | 0 X00X | Load peripheral byte of digital inputs into accu 1, bypassing the process image |
| L | PW | 0 to 254 | 12.0 | 7 0111 | A 1010 | 0 X00X | 0 X00X | Load peripheral byte of digital inputs/outputs into accu 1, bypassing the process image |
| LD | T | 0 to 127 | 10.75 | 0 0000 | C 1100 | 0 X00X | 0 X00X | Load time (BCD) of timer into accu 1 |
| LD | C | 0 to 63 | 40.5 | 4 0100 | C 1100 | 0 X00X | 0 X00X | Load count (BCD) of counter into accu 1 |
| T | IB | 0 to 127° | 40.0 | 4 0100 | B 1011 | 0 000X | 0 X00X | Transfer contents of accu 1 to input byte of process input image |
| T | IW | 0 to 126° | 4.0 | 5 0101 | 3 0011 | 0 000X | 0 X00X | Transfer contents of accu 1 to input word of process input image |
| T | QB | 0 to 127° | 4.0 | 4 0100 | B 1011 | 8 100X | 0 X00X | Transfer contents of accu 1 to output byte of process output image |
| T | QW | 0 to 126° | 4.0 | 5 0101 | 3 0011 | 8 100X | 0 X00X | Transfer contents of accu 1 to output word of process output image |
| T | FB | 0 to 255 | 4.0 | 0 0000 | B 1011 | 0 X00X | 0 X00X | Transfer contents of accu 1 to flag byte |
| T | FW | 0 to 254 | 4.0 | 1 0001 | 3 0011 | 0 X00X | 0 X00X | Transfer contents of accu 1 to flag word |
| T | DR | 1 to 255 | 24.5 | 2 0010 | B 1011 | 0 X00X | 0 X00X | Transfer contents of accu 1 to the word (right-hand byte) of current actual data block |
| T | DL | 1 to 255 | 23.5 | 2 0010 | 3 0011 | 0 X00X | 0 X00X | Transfer contents of accu 1 to the word (left-hand byte) of current data block |
| T | DW | 1 to 255 | 25.25 | 3 0011 | 3 0011 | 0 X00X | 0 X00X | Transfer contents of accu 1 to the word of current data block |
| T | PB | 0 to 255 | 10.5 | 7 0111 | 3 0011 | 0 X00X | 0 X00X | Transfer contents of accu 1 directly to peripheral byte |
| T | PW | 0 to 254 | 12.25 | 7 0111 | B 1011 | 0 X00X | 0 X00X | Transfer contents of accu 1 directly to peripheral word |

| Operation | Parameter | Cycla time (µs) | Operation code | | | | Condition codes | | Function |
|-----------|---------------------------|-----------------|----------------|-----------|------------|------------|-----------------|--|---|
| | | | Byte 0 | Byte 1 | RLO | FIB | | | |
| L | KB 0 to 255 | 3.25 | 2 0010 | 8 1000 | 0 X000X | 0 X000X | | | Load constant number (1 byte) into accu 1 |
| L | KS* 2ASCII character | 5.5 | 3 0011 | 0 0000 | 1 0001 | 0 0000 | | | Load constant character into accu 1 |
| L | KF* -32768 to +32767 | 5.5 | 3 0011 | 0 0000 | 0 0000 | 4 0100 | | | Load constant fixed-point number into accu 1 |
| L | KH* 0 to FFFF | 5.5 | 3 0011 | 0 0000 | 4 0100 | 0 0000 | | | Load constant number (hexadecimal code) into accu 1 |
| L | KM* 0000...00 to 111...11 | 5.5 | 3 0011 | 0 0000 | 8 1000 | 0 0000 | | | Load constant bit pattern of a word (2 bytes) into accu 1 |
| L | KY* 0 to 255, 0 to 255 | 5.5 | 3 0011 | 0 0000 | 2 0010 | 0 0000 | | | Load constant number (2 bytes) into accu 1 |
| L | KT* 0.0 to 999.3 | 5.5 | 3 0011 | 0 0000 | 0 0000 | 2 0010 | | | Load constant number (2 bytes) as time into accu 1 |
| L | KC* 0 to 999 | 5.5 | 3 0011 | 0 0000 | 0 0000 | 1 0001 | | | Load constant number (2 bytes) as count into accu 1 |

*) These are 4-bytes operations in which the constants are in bytes 2 and 3.

Comparison functions

| | | | | | | | | | |
|-------|---|------|-----------|-----------|-----------|--------|--|--|--|
| I = F | — | 8.75 | 2 0010 | 1 0001 | 8 1000 | 0 — | | | Fixed-point comparison for accu1 equal to accu2. If equal, RLO="1"; condition code < 0 and > 0 |
| > F | — | 9.0 | 2 0010 | 1 0001 | 2 0010 | 0 — | | | Fixed-point comparison for accu1 > accu2. If accu2 > accu1, RLO="1"; condition code < 0 or > 0 |
| < F | — | 9.0 | 2 0010 | 1 0001 | 4 0100 | 0 — | | | Fixed-point comparison for accu1 < accu2. If accu2 < accu1, RLO="1"; condition code < 0 or > 0 |

Note:

The programmable controller has two accumulators for comparison and arithmetic functions and for digital operations. Loading means that the contents of accu 1 are transferred to accu 2 and that accu 1 is newly loaded according to the operands in the load operation. After two load operations, information on the contents of the accumulators can be obtained with comparison operations.

Example:



A transfer operation always transfers the contents of accu 1 to the operands specified in the transfer operation.

| Operation | Parameter | Cycle time (μs) | Operation code | | Condition codes | | Function | |
|--------------------|-----------|-----------------|----------------|-------------------|-----------------|--------|----------|--|
| | | | Byte 0 | Byte 1 | RLO | FIB | | |
| Block calls | | | | Word addr. | | | | |
| JU | PB | 0 to 255 | 30.75 | 7 0111 | 5 0101 | 0 X00X | 0 X00X | Jump unconditionally to program block |
| JU | FB | 0 to 255 | 30.75 | 3 0011 | D 1101 | 0 X00X | 0 X00X | Jump unconditionally to function block |
| JU | OB | 1 | 30.25 | 6 0110 | D 1101 | 0 X00X | 0 X00X | Jump unconditionally to organisation block |
| JC | PB | 0 to 255 | 31.75 | 5 0101 | 5 0101 | 0 X00X | 0 X00X | Jump conditionally to program block |
| JC | FB | 0 to 255 | 30.25 | 1 0001 | D 1101 | 0 X00X | 0 X00X | Jump conditionally to function block |
| JC | OB | 1 | 8.0 | 4 0100 | D 1101 | 0 X00X | 0 X00X | Jump conditionally to organisation block |
| C | DB | 1 to 241 | 19.25 | 2 0010 | 0 0000 | 0 X00X | 0 X00X | Call data block; the data block is valid until another DB is called. |
| BE | — | — | 23.5 | 6 0110 | 5 0101 | 0 0000 | 0 0000 | Unconditional end of block |
| BEC | — | — | 23.15 | 0 0000 | 5 0101 | 0 0000 | 0 0000 | Conditional end of block |

Other operations

| | | | | | | | | |
|-------|----------|---|------|--------|--------|--------|--------|--|
| NOP 0 | — | — | 3.25 | 0 0000 | 0 0000 | 0 0000 | 0 0000 | No operation (all bits deleted) |
| NOP 1 | — | — | 3.25 | F 1111 | F 1111 | F 1111 | F 1111 | No operation (all bits set) |
| STP | — | — | 11.5 | 7 0111 | 0 0000 | 0 0000 | 3 0011 | Programmable stop operation (at the end of the cycle, the programmable controller stops) |
| BLD | 0 to 255 | — | 3.25 | 1 0001 | 0 0000 | 0 X00X | 0 X00X | Display construction statement for the programming unit |
| DBS | 0 to 255 | — | 7.5 | 1 0001 | 8 1010 | 0 X00X | 0 X00X | An operation in the system data range is to be executed |
| STS | — | — | 38.5 | 7 0111 | 0 0000 | 0 0000 | 0 0000 | System stop |
| TAK | — | — | 4.25 | 7 0111 | 0 0000 | 0 0000 | 2 0010 | Interchange the contents of accumulator 1 and 2 |

Load and transfer operations (system operations)

| | | | | | | | | |
|-----|----------|---|-------|--------|--------|--------|--------|---|
| LIR | 0 to 2 | — | 13.25 | 4 0100 | 0 0000 | 0 X00X | 0 X00X | Load register (indirectly) with the contents of the memory word addressed by accumulator 1 |
| TIR | 0 to 2 | — | 13.0 | 4 0100 | 8 1000 | 0 X00X | 0 X00X | Transfer the register contents (indirectly) onto the memory word addressed by accumulator 1 |
| TNB | 0 to 255 | — | 842 | 0 | 3 | 0 X00X | 0 X00X | Block transfer in the byte mode |
| TBS | 0 to 255 | — | 10.75 | 6 0110 | 3 0011 | 0 X00X | 0 X00X | Transfer word to the system data area |

Arithmetic operations

| | | | | | | | | |
|-------|----------------------|---|------|--------|--------|--------|--------|--|
| ADDBN | ± 127 | — | 3.25 | 5 0000 | 0 0000 | 0 X00X | 0 X00X | Add byte constant (fixed-point) to the contents of accumulator 1 |
| ADDF | -32768 $+32767$ | — | 5.5 | 5 0101 | 8 1010 | 0 X00X | 0 X00X | Add fixed-point constant (word) to the contents of accumulator 1 |

| Operation | Parameter | Cycle time (μs) | Operation code | | Condition codes | | Function |
|-----------|-----------|-----------------|----------------|--------|-----------------|-----|----------|
| | | | Byte 0 | Byte 1 | RLO | FIB | |

Digital logic functions

| | | | | | | | |
|-----|---|------|-----------|-----------|--------|--|--|
| AN | — | 3.25 | 4 0100 | 1 0001 | 0 0 | | Digital ANDing of accu1 and accu2 (word for word); result stored in accu1; <0 or >0 |
| ON | — | 3.25 | 4 0100 | 9 0001 | 0 0 | | Digital ORing of accu1 and accu2 (word for word); result stored in accu1; <0 or >0 |
| XON | — | 3.25 | 5 0101 | 1 0001 | 0 0 | | Digital EXORing of accu1 and accu2 (word for word); result stored in accu1; <0 or >0 |

Arithmetic functions

| | | | | | | | |
|----|---|------|-----------|-----------|--------|--|--|
| +F | — | 5.25 | 7 0111 | 9 1001 | 0 0 | | Add accu 1 to accu 2; result stored in accu 1; <0, >0 or OV |
| -F | — | 9.5 | 5 0101 | 9 1001 | 0 0 | | Subtract accu 1 from accu 2; result stored in accu 1; <0, >0 or OV |

Jump functions

| | | | Word addr. ±127 | | | | | |
|------|--------------------------------|------|--------------------|-----------|-----------|-----------|---|--|
| JU - | "Label" (4ASCII characters) | 7.5 | 2 0010 | D 1101 | 0 XXXX | 0 XXXX | | Jump unconditionally to label, consisting of 4ASCII characters. Jump displacement ≠ ±127 words. |
| JC - | "Label" (4ASCII characters) | 8.75 | F 1111 | A 1010 | 0 XXXX | 0 XXXX | X | Jump conditionally (if RLO=1) to label, consisting of 4ASCII characters. Jump displacement ≠ ±127 words. |
| JZ - | "Label" (4ASCII characters) | 8.75 | 4 0100 | 5 0101 | 0 XXXX | 0 XXXX | | Jump conditionally (if result-zero) to label, consisting of 4ASCII characters. Jump displacement ≠ ±127 words. |
| JO - | "Label" (4ASCII characters) | 8.75 | 0 0000 | D 1101 | 0 XXXX | 0 XXXX | | Jump conditionally (if condition code OV=1) to label, consisting of 4ASCII characters. Jump displacement ≠ ±127 words. |
| JUR- | -32768 to +32767 | 9.0 | 7 0111 | 0 0000 | 0 0000 | 8 1011 | | Skip system software unconditionally |

Timer and counter functions

| | | | Word addr. | | | | | |
|-----|----------|------|------------|-----------|-----------|-----------|---|--|
| FRT | 0 to 127 | 5.75 | 0 0000 | 4 0100 | 0 XXXX | 0 XXXX | X | Enable timer for cold restart (only on positive going edge of RLO) |
| FRC | 0 to 63 | 5.5 | 4 0100 | 4 0100 | 0 XXXX | 0 XXXX | X | Enable counter for cold restart (only on positive going edge of RLO) |

| Operation | Parameter | Cycle time (μs) | Operation code | | Condition codes | | Function |
|-----------|-----------|-----------------|----------------|--------|-----------------|-----|----------|
| | | | Byte 0 | Byte 1 | RLO | FIB | |

Shift functions

| | | | | | | | Par. | |
|-----|---------|-------|-----------|-----------|-----------|-----------|------|--|
| SLW | 0 to 15 | 60.25 | 6 0110 | 1 0001 | 0 0000 | 0 XXXX | | Shift contents of accu to the left. The bit positions to the right which become vacant are padded with zeroes. |
| SRW | 0 to 15 | 60.25 | 6 0110 | 9 1001 | 0 0000 | 0 XXXX | | Shift contents of accu to the right. The bit positions to the left which become vacant are padded with zeroes. |

Conversion functions

| | | | | | | | | |
|-----|---|-----|-----------|-----------|--------|--------|--|---|
| CFW | — | 3.5 | 0 0000 | 1 0001 | 0 — | 0 0 | | One's complement of accu 1 |
| CSW | — | 3.5 | 0 0000 | 9 1001 | 0 — | 0 0 | | Two's complement of accu 1; <0,> 0 or 0V; |

Decrementing/incrementing

| | | | | | | | Dec./Incr. | |
|---|----------|------|-----------|-----------|-----------|-----------|------------|---|
| | | | | | | | 0 to 255 | |
| D | 1 to 255 | 3.5 | 1 0001 | 9 1001 | 0 XXXX | 0 XXXX | | Decrement only the low-order byte of accu 1 by a particular value |
| I | 1 to 255 | 3.25 | 1 0001 | 1 1001 | 0 XXXX | 0 XXXX | | Increment only the low-order byte of accu 1 by a particular value |

Processing functions

| | | | | | | | Word addr. | |
|----|----|----------|-----------|-----------|-----------|-----------|------------|---|
| DO | FW | 0 to 254 | 4 0100 | E 1110 | 0 XXXX | 0 XXXX | | Process flag word. The next operation specified is combined with the parameter in the flag word and executed. |
| DO | DW | 0 to 255 | 6 0110 | E 1110 | 0 XXXX | 0 XXXX | | Process data word. The next operation specified is combined with the parameter in the data word and executed. |

Disable/enable command output

| | | | | | | | | |
|-----|---|------|-----------|-----------|--------|--------|---|------------------------|
| BAS | — | 3.25 | B 1011 | E 1110 | 0 — | 0 0 | X | Disable command output |
| BAF | — | 3.25 | F 1111 | E 1110 | 0 — | 0 0 | X | Enable command output |

Disable/enable interrupts

| | | | | | | | | |
|----|---|------|-----------|-----------|-----------|-----------|--|------------------------------|
| IA | — | 3.25 | 0 0000 | B 1000 | 0 0000 | 0 0000 | | Inhibit interrupt processing |
| RA | — | 3.25 | 0 0000 | B 1000 | 0 1000 | B 0000 | | Enable interrupt processing |

Instruction Set 130 WB

Logic operations, binary

| Operator | Format | Machine code (hexadecim.) | | | | | | | | Condition codes affected? | | | Execution time (cycles) | Function |
|--------------------|--------|---------------------------|----|----|----|--------|----|----|----|---------------------------|-----|------|-----------------------------|----------|
| | | Word 0 | | | | Word 1 | | | | CC1 | CC0 | OV | | |
| | | B0 | B1 | B2 | B3 | B4 | B5 | B6 | B7 | | | | | |
| AND operation with | | | | | | | | | | | | | | |
| A | I | 0.0 to 63.7 | CD | 8D | - | - | N | N | - | - | - | 4.8 | scanning of input for "1" | |
| A | O | 0.0 to 63.7 | CD | 8D | - | - | N | N | - | - | - | 3.5 | scanning of output for "1" | |
| A | F | 0.0 to 255.7 | BD | 8D | - | - | N | N | - | - | - | 3.5 | scanning of flag for "1" | |
| A | T | 0 to 127 | FD | 8D | - | - | N | N | - | - | - | 3.5 | scanning of timer for "1" | |
| A | C | 0 to 127 | BD | 8D | - | - | N | N | - | - | - | 3.75 | scanning of counter for = 0 | |
| AN | I | 0.0 to 63.7 | BD | 8D | - | - | N | N | - | - | - | 3.5 | scanning of input for "0" | |
| AN | O | 0.0 to 63.7 | BD | 8D | - | - | N | N | - | - | - | 3.5 | scanning of output for "0" | |
| AN | F | 0.0 to 255.7 | AD | 8D | - | - | N | N | - | - | - | 3.5 | scanning of flag for "0" | |
| AN | T | 0 to 127 | FD | 8D | - | - | N | N | - | - | - | 3.5 | scanning of timer for "0" | |
| AN | C | 0 to 63 | BD | 8D | - | - | N | N | - | - | - | 3.75 | scanning of counter for = 0 | |
| OR operation with | | | | | | | | | | | | | | |
| O | I | 0.0 to 63.7 | CB | 8D | - | - | N | N | - | - | - | 3.5 | scanning of input for "1" | |
| O | O | 0.0 to 63.7 | CB | 8D | - | - | N | N | - | - | - | 3.5 | scanning of output for "1" | |
| O | F | 0.0 to 255.7 | BB | 8D | - | - | N | N | - | - | - | 3.5 | scanning of flag for "1" | |
| O | T | 0 to 127 | FB | 8D | - | - | N | N | - | - | - | 3.5 | scanning of timer for "1" | |
| O | C | 0 to 63 | BB | 8D | - | - | N | N | - | - | - | 3.75 | scanning of counter for > 0 | |
| ON | I | 0.0 to 63.7 | EB | 8D | - | - | N | N | - | - | - | 3.5 | scanning of input for "0" | |
| ON | O | 0.0 to 63.7 | EB | 8D | - | - | N | N | - | - | - | 3.5 | scanning of output for "0" | |
| ON | F | 0.0 to 255.7 | AB | 8D | - | - | N | N | - | - | - | 3.5 | scanning of flag for "0" | |
| ON | T | 0 to 127 | FD | 8D | - | - | N | N | - | - | - | 3.5 | scanning of timer for "0" | |
| ON | C | 0 to 63 | BD | 8D | - | - | N | N | - | - | - | 3.75 | scanning of counter for = 0 | |

→ retrieve address

→ bit address

| Operator | Format | Machine code (hexadecim.) | | | | | | | | Condition codes affected? | | | Execution time (cycles) | Function |
|----------|--------|---------------------------|----|----|----|--------|----|----|----|---------------------------|-----|------|--------------------------------|----------|
| | | Word 0 | | | | Word 1 | | | | CC1 | CC0 | OV | | |
| | | B0 | B1 | B2 | B3 | B4 | B5 | B6 | B7 | | | | | |
| I | | | BF | 8D | - | - | N | Y | - | - | - | 3.5 | Right parenthesis | |
| U | | | BA | 8D | - | - | N | Y | - | - | - | 4.75 | ANDing of bracketed expression | |
| O | | | BB | 8D | - | - | N | Y | - | - | - | 4.25 | ORing of bracketed expression | |
| O | | | FB | 8D | - | - | N | Y | - | - | - | 3.5 | ORing of AND functions | |

Setting/resetting operations

| Operator | Parameter | Machine code (address) | | | | | | Counter code (offset) | | | Function | | |
|----------|-----------|------------------------|----|--------|----|----|----|-----------------------|-----|----|----------|------|-------------------|
| | | Word 0 | | Word 1 | | M0 | M1 | CC1 | CC0 | Ov | | | |
| | | B0 | B1 | B2 | B3 | | | | | | | | |
| Set | | | | | | | | | | | | | |
| S | I | 0.0 to 63.7 | D0 | 00 | - | - | Y | Y | - | - | - | 4.8 | an input (in P1) |
| S | O | 0.0 to 63.7 | D0 | 00 | - | - | Y | Y | - | - | - | 4.5 | an output (in P1) |
| S | F | 0.0 to 255.7 | 00 | 00 | - | - | Y | Y | - | - | - | 3.75 | a flag |
| Reset | | | | | | | | | | | | | |
| R | I | 0.0 to 63.7 | P0 | 00 | - | - | Y | Y | - | - | - | 4.8 | an input (in P1) |
| R | O | 0.0 to 63.7 | P0 | 00 | - | - | Y | Y | - | - | - | 4.5 | an output (in P1) |
| R | F | 0.0 to 255.7 | 00 | 00 | - | - | Y | Y | - | - | - | 4.75 | a flag |
| Assign | | | | | | | | | | | | | |
| = | I | 0.0 to 63.7 | D8 | 00 | - | - | N | Y | - | - | - | 4.8 | an input (in P1) |
| = | O | 0.0 to 63.7 | D8 | 00 | - | - | N | Y | - | - | - | 4.5 | an output (in P1) |
| = | F | 0.0 to 255.7 | 00 | 00 | - | - | N | Y | - | - | - | 3.75 | a flag |

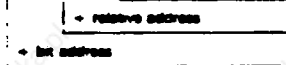

Timer and counter operations

| Operator | Parameter | Machine code (address) | | | | | | Counter code (offset) | | | Function | | |
|----------|-----------|------------------------|----|--------|----|----|----|-----------------------|-----|----|----------|------|----------------------------------|
| | | Word 0 | | Word 1 | | M0 | M1 | CC1 | CC0 | Ov | | | |
| | | B0 | B1 | B2 | B3 | | | | | | | | |
| SP | T | 0 to 127 | 34 | 00 | - | - | Y | Y | - | - | - | 21.5 | Start timer as pulse |
| SE | T | 0 to 127 | 1C | 00 | - | - | Y | Y | - | - | - | 21.5 | Start timer as extended pulse |
| SP | T | 0 to 127 | 24 | 00 | - | - | Y | Y | - | - | - | 21.5 | Start timer as "On" delay |
| SS | T | 0 to 127 | 2C | 00 | - | - | Y | Y | - | - | - | 21.5 | Start timer as stored "On" delay |
| SF | T | 0 to 127 | 14 | 00 | - | - | Y | Y | - | - | - | 21.5 | Start timer as "Off" delay |
| R | T | 0 to 127 | 3C | 00 | - | - | Y | Y | - | - | - | 5.75 | Reset timer |
| S | C | 0 to 63 | 9C | 00 | - | - | Y | Y | - | - | - | 23.5 | Set counter |
| R | C | 0 to 63 | 7C | 00 | - | - | Y | Y | - | - | - | 5.5 | Reset counter |
| CU | C | 0 to 63 | 0C | 00 | - | - | Y | Y | - | - | - | 6.8 | Increment counter (count up) |
| CD | C | 0 to 63 | 84 | 00 | - | - | Y | Y | - | - | - | 7.5 | Decrement counter (count down) |

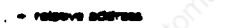

Load and transfer operations

| Operation | Portname | Address and mask (bits) | | | | R/O | N | Z | Control status (bits) | | | Execution time in cycles | Function |
|---------------------|----------|---------------------------|----|--------|----|-----|---|---|-----------------------|----|----|--------------------------|---|
| | | Word 0 | | Word 1 | | | | | OC | OD | OV | | |
| | | 00 | 01 | 02 | 03 | | | | | | | | |
| + relative address | | | | | | | | | | | | | |
| Load | | | | | | | | | | | | | |
| L | IB | 0 to 63 | 4A | 80 | - | - | N | N | - | - | - | 4.25 | an input byte from PII |
| L | IW | 0 to 62 | 62 | 80 | - | - | N | N | - | - | - | 4.75 | an input word from PII |
| L | OB | 0 to 63 | 4A | 80 | - | - | N | N | - | - | - | 4.25 | an output byte from PIO |
| L | OW | 0 to 62 | 62 | 80 | - | - | N | N | - | - | - | 4.75 | an output word from PIO |
| L | FB | 0 to 255 | 0A | 80 | - | - | N | N | - | - | - | 4.25 | a flag byte |
| L | PW | 0 to 254 | 12 | 80 | - | - | N | N | - | - | - | 5.8 | a flag word |
| L | DL | 0 to 255 | 22 | 80 | - | - | N | N | - | - | - | 13.8 | a data byte (left-hand byte) |
| L | DR | 0 to 255 | 2A | 80 | - | - | N | N | - | - | - | 14.25 | a data byte (right-hand byte) |
| L | DW | 0 to 255 | 32 | 80 | - | - | N | N | - | - | - | 12.5 | a data word |
| L | T | 0 to 127 | 02 | 80 | - | - | N | N | - | - | - | 5.5 | a time |
| L | C | 0 to 63 | 42 | 80 | - | - | N | N | - | - | - | 5.5 | a count |
| L | PB | 0 to 127 128 to 255 | 72 | 80 | - | - | N | N | - | - | - | 18.25 | a peripheral byte of the digital inputs a peripheral byte of the analog inputs |
| L | PW | 0 to 128 128 to 254 | | 80 | - | - | N | N | - | - | - | 11.75 | a peripheral word of the digital inputs a peripheral word of the analog inputs |
| LD | T | 0 to 127 | 0C | 80 | - | - | N | N | - | - | - | 25.8 | a time (BCD) |
| LD | C | 0 to 63 | 4C | 80 | - | - | N | N | - | - | - | 25.8 | a count (BCD) |
| + relative address | | | | | | | | | | | | | |
| Load a constant | | | | | | | | | | | | | |
| L | KB | 0 to 255 | 38 | 80 | - | - | N | N | - | - | - | 4.8 | 1 byte |
| + constant (1 byte) | | | | | | | | | | | | | |
| Load a constant | | | | | | | | | | | | | |
| L | KS | 2 alphanumeric characters | 30 | 10 | 80 | 80 | N | N | - | - | - | 7.8 | 2 ASCII characters |
| L | KM | 8n pattern (16 bits) | 30 | 80 | 00 | 00 | N | N | - | - | - | 7.8 | as bit pattern |
| L | KH | 0 to FFFF | 30 | 40 | 00 | 00 | N | N | - | - | - | 7.8 | in hexadecimal code |
| L | KF | 0 to (2 ⁿ -1) | 30 | 04 | 00 | 00 | N | N | - | - | - | 7.8 | as fixed-point number |
| L | KY | 0 to 255 each byte | 30 | 20 | 80 | 80 | N | N | - | - | - | 7.8 | 2 bytes |
| L | KT | 0.0 to 999.3 | 30 | 02 | 00 | 00 | N | N | - | - | - | 7.8 | as a time |
| L | KC | 0 to 999 | 30 | 01 | 80 | 80 | N | N | - | - | - | 7.8 | as a count |
| + constant (1 word) | | | | | | | | | | | | | |
| Transfer | | | | | | | | | | | | | |
| T | IB | 0 to 63 | 48 | 80 | - | - | N | N | - | - | - | 4.25 | to an input byte (in PII) |
| T | IW | 0 to 62 | 60 | 80 | - | - | N | N | - | - | - | 4.25 | to an input word (in PII) |
| T | OB | 0 to 63 | 48 | 80 | - | - | N | N | - | - | - | 4.25 | to an output byte (in PIO) |
| T | OW | 0 to 62 | 60 | 80 | - | - | N | N | - | - | - | 4.25 | to an output word (in PIO) |
| T | FB | 0 to 255 | 08 | 80 | - | - | N | N | - | - | - | 4.25 | to a flag byte |
| T | PW | 0 to 254 | 10 | 80 | - | - | N | N | - | - | - | 4.25 | to a flag word |
| T | DR | 0 to 255 | 28 | 80 | - | - | N | N | - | - | - | 15.5 | to a data byte (right-hand byte) |
| T | DL | 0 to 255 | 20 | 80 | - | - | N | N | - | - | - | 14.25 | to a data byte (left-hand byte) |
| T | DW | 0 to 255 | 30 | 80 | - | - | N | N | - | - | - | 13 | to a data word |
| T | PB | 0 to 127 128 to 255 | 70 | 80 | - | - | N | N | - | - | - | 8.25 | to a peripheral byte of the digital outputs with updating of the PIO to a peripheral byte of the analog outputs without updating the PIO |
| T | PW | 0 to 128 128 to 254 | 78 | 80 | - | - | N | N | - | - | - | 9.25 | to a peripheral word of the digital outputs with updating of the PIO to a peripheral word of the analog outputs without updating the PIO |
| + relative address | | | | | | | | | | | | | |

Comparison operators

| Operator | Preset | Machine code (hexadecimal) | | | | Z | NC | Condition code affected? | | | Instruction length (bytes) | Function |
|----------|--------|----------------------------|----|--------|----|---|----|--------------------------|-----|----|----------------------------|------------------------------|
| | | Word 0 | | Word 1 | | | | CC1 | CC0 | OV | | |
| | | B0 | B1 | B2 | B3 | | | | | | | |
| | | | | | | | | | | | | Compare fixed-point numbers |
| = F | | 21 | 80 | - | - | N | N | Y | Y | - | 7.5 | for equal to |
| >< F | | 21 | 80 | - | - | N | N | Y | Y | - | 7.5 | for not equal to |
| > F | | 21 | 20 | - | - | N | N | Y | Y | - | 7.5 | for greater than |
| >= F | | 21 | A0 | - | - | N | N | Y | Y | - | 7.5 | for greater than or equal to |
| < F | | 21 | 40 | - | - | N | N | Y | Y | - | 7.5 | for less than |
| <= F | | 21 | C0 | - | - | N | N | Y | Y | - | 7.5 | for less than or equal to |

Arithmetic operations

| | | | | | | | | | | | | |
|-----|--|----|----|---|---|---|---|---|---|---|------|--------------------------|
| + F | | 7B | 80 | - | - | N | N | Y | Y | Y | 4.75 | Addition, fixed-point |
| - F | | 8B | 80 | - | - | N | N | Y | Y | Y | 8.25 | Subtraction, fixed-point |

Block calls

| | | | | | | | | | | | | Unconditional jump | |
|------------------------------|----|----------|----|----|--|--|---|---|---|---|---|--------------------|------------------------------|
| JU | FB | 0 to 255 | 75 | 80 | | | N | Y | - | - | - | 40 | to a program block |
| JU | FB | 0 to 255 | 3D | 80 | | | N | Y | - | - | - | 40 | to a function block |
| JU | SB | 0 to 255 | 7D | 80 | | | N | Y | - | - | - | 40 | to a sequence block |
| | | | | | | | | | | | | Conditional jump | |
| JC | FB | 0 to 255 | 85 | 80 | | | Y | Y | - | - | - | 23.25 | to a program block |
| JC | FB | 0 to 255 | 1D | 80 | | | Y | Y | - | - | - | 23.25 | to a function block |
| JC | SB | 0 to 255 | 8D | 80 | | | Y | Y | - | - | - | 23.25 | to a sequence block |
| C | DB | 0 to 255 | 2D | 80 | | | N | N | - | - | - | 25.25 | Calling of a data block |
| = Block number (hexadecimal) | | | | | | | | | | | | | |
| BE | | | 85 | 80 | | | N | Y | - | - | - | 29 | Block end |
| BEC | | | 85 | 80 | | | Y | Y | - | - | - | 16.5 | Block end, conditional |
| BEU *) | | | 85 | 01 | | | N | Y | - | - | - | 29 | Block end, unconditional **) |

*) If a block is ended with BEU, an NOP statement must be inserted after the respective block call.
Reason: When the jump back is made after BEU the statement following the block call is skipped.

**) Only permitted in FB, FB and SB.

Other functions

| Operator | Preset | Machine code (hexadecimal) | | | | Z | NC | Condition code affected? | | | Instruction length (bytes) | Function |
|----------|--------|----------------------------|----|--------|----|---|----|--------------------------|-----|----|----------------------------|---|
| | | Word 0 | | Word 1 | | | | CC1 | CC0 | OV | | |
| | | B0 | B1 | B2 | B3 | | | | | | | |
| NOP | 0 | 80 | 80 | | | N | N | - | - | - | 3.5 | No operation (all bits reset) |
| NOP | 1 | FF | FF | | | N | N | - | - | - | 3.5 | No operation (all bits set) |
| STP | | 70 | 8B | | | N | N | - | - | - | 13.5 | Stop |
| BLD | 255 | 90 | FF | | | N | N | - | - | - | 3.5 | Segment end for programming in STL. Used for LAD on programming unit. |

Logic operations, digital (supplementary operations)

| Operation | Parameter | Machine code (accumulator) | | | | RLO dependent? | RLO reset? | Condition code affected? | | | Execution time (cycles) | Function |
|-----------|-----------|----------------------------|----|--------|----|----------------|------------|--------------------------|-----|----|-------------------------|---------------------------|
| | | Word 0 | | Word 1 | | | | CC1 | CC2 | OV | | |
| | | B0 | B1 | B2 | B3 | | | | | | | |
| AW | | 41 | 00 | | | N | N | X | X | - | 3.25 | ANDing |
| OW | | 00 | 00 | | | N | N | X | X | - | 3.5 | ORing |
| XOW | | 51 | 00 | | | | | X | X | - | 3.25 | Exclusive ORing of ACCU 1 |

Logic operations, binary (supplementary operations)

| Operation | Parameter | Machine code (accumulator) | RLO dependent? | RLO reset? | Condition code affected? | Execution time (cycles) | Function | | | | | |
|-----------|------------------|----------------------------|----------------|------------|--------------------------|-------------------------|----------|---|---|---|------|---|
| | | Word 0 | | | | | | | | | | |
| | | B0 | B1 | B2 | B3 | | | | | | | |
| A | = Formal operand | 7A | 00 | | | N | N | - | - | - | 38.5 | AND operation with scanning of formal operand for "1" |
| AN | = Formal operand | 27 | 00 | | | N | N | - | - | - | 38.5 | AND operation with scanning of formal operand for "0" |
| O | = Formal operand | 0F | 00 | | | N | N | - | - | - | 38.5 | OR operation with scanning of formal operand for "1" |
| ON | = Formal operand | 2F | 00 | | | N | N | - | - | - | 38.5 | OR operation with scanning of formal operand for "0" |

- Parameter address

Timer and counter operations (supplementary operations)

| Operation | Parameter | Machine code (accumulator) | | | | RLO dependent? | RLO reset? | Condition code affected? | | | Execution time (cycles) | Function |
|-----------|------------------|----------------------------|----|--------|----|----------------|------------|--------------------------|-----|----|-------------------------|---|
| | | Word 0 | | Word 1 | | | | CC1 | CC2 | OV | | |
| | | B0 | B1 | B2 | B3 | | | | | | | |
| FT | 0 to 127 | 04 | 00 | | | Y | Y | - | - | - | 4.5 | Enable a timer for cold restart. The operation is executed only at the positive-going edge of the RLO. The cold restart of the timer results only when the RLO is "1" at the time of the start operation. |
| FC | 0 to 63 | 44 | 00 | | | Y | Y | - | - | - | 4.5 | Enable a counter for cold restart. The operation is executed only at the positive-going edge of the RLO. The setting, up or down counting results only if the RLO is "1" at the time of the corresponding operation. |
| FE | = Formal operand | 08 | 00 | | | N | N | - | - | - | 32.25 | Enable a formal operand for cold restart. (For description, see FT or FC depending on formal operand, parameter type: T, C) |
| SP | = Formal operand | 38 | 00 | | | N | N | - | - | - | 32.25 | Start a timer specified as a formal operand as pulse with the value stored in the accumulator (Parameter type: T) |
| SA | = Formal operand | 28 | 00 | | | N | N | - | - | - | 32.25 | Start a timer specified as a formal operand as "On" delay with the value stored in the accumulator (Parameter type: T) |
| SEC | = Formal operand | 1E | 00 | | | N | N | - | - | - | 32.25 | Start a timer specified as a formal operand as an extended pulse with the value stored in the accumulator or set a counter specified as a formal operand with the value subsequently specified (parameter type: T, C) |
| SSU | = Formal operand | 2E | 00 | | | N | N | - | - | - | 32.25 | Start a timer specified as a formal operand as stored "On" delay with the value stored in the accumulator or increment a counter specified as a formal operand (Parameter type: T, C) |
| SFD | = Formal operand | 16 | 00 | | | N | N | - | - | - | 32.25 | Start a timer specified as a formal operand as "Off" delay with the value stored in the accumulator or decrement a counter specified as a formal operand (parameter type: T, C) |
| RD | = Formal operand | 3E | 00 | | | N | N | - | - | - | 32.25 | Reset a formal operand for timers and counters (parameter type: T, C) |

- parameter address

Bit test functions (supplementary operations)

| Operator | Format | Machine code (hexadecimal) | | | | R0 length | R0 mask | Condition code (mask) | | | Operation time in cycles | Function | |
|----------|--------|----------------------------|----|--------|----|--------------|------------|-----------------------|-----|----|-----------------------------|----------------------|------------------------|
| | | Word 0 | | Word 1 | | | | CC1 | CC0 | OV | | | |
| | | 00 | 01 | 02 | 03 | | | | | | | | |
| | | | | | | | | | | | | Check bit for "1" of | |
| TB | T | 0.0 to 127.15 | 70 | 25 | 00 | 00 | N | N | - | - | - | 13.75 | a timer word |
| TB | C | 0.0 to 63.15 | 70 | 15 | 00 | 00 | N | N | - | - | - | 14.5 | a counter word |
| TB | D | 0.0 to 255.15 | 70 | 45 | 00 | 00 | N | N | - | - | - | 22.0 | a data word |
| TB | RS | 0.0 to 255.15 | 70 | 57 | 00 | 00 | N | N | - | - | - | 19.75 | system data area |
| TB | Ri | 0.0 to 255.15 | 70 | 47 | 00 | 00 | N | N | - | - | - | 19.75 | interface data area |
| | | | | | | | | | | | | | Check bit for "0" |
| TBN | T | 0.0 to 127.15 | 70 | 25 | 80 | 80 | N | N | - | - | - | 13.75 | of a timer word |
| TBN | C | 0.0 to 63.15 | 70 | 15 | 80 | 80 | N | N | - | - | - | 14.5 | of a counter word |
| TBN | D | 0.0 to 255.15 | 70 | 45 | 80 | 80 | N | N | - | - | - | 22.0 | of a data word |
| TBN | RS | 0.0 to 255.15 | 70 | 57 | 80 | 80 | N | N | - | - | - | 19.75 | of system data area |
| TBN | Ri | 0.0 to 255.15 | 70 | 47 | 80 | 80 | N | N | - | - | - | 19.75 | of interface data area |

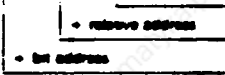

Bit set operations (supplementary operations)

| | | | | | | | | | | | | Set bit unconditionally | |
|----|----|---------------|----|----|----|----|---|---|---|---|---|---------------------------|------------------------|
| SU | T | 0.0 to 127.15 | 70 | 25 | 40 | 80 | N | Y | - | - | - | 12.75 | of a timer word |
| SU | C | 0.0 to 63.15 | 70 | 15 | 40 | 80 | N | Y | - | - | - | 13.5 | of a counter word |
| SU | D | 0.0 to 255.15 | 70 | 45 | 40 | 80 | N | Y | - | - | - | 23.0 | of a data word |
| SU | Ri | 0.0 to 255.15 | 70 | 47 | 40 | 80 | N | Y | - | - | - | 20.25 | of interface data area |
| | | | | | | | | | | | | Reset bit unconditionally | |
| RU | T | 0.0 to 127.15 | 70 | 25 | 80 | 80 | N | Y | - | - | - | 12.75 | of a timer word |
| RU | C | 0.0 to 63.15 | 70 | 15 | 80 | 80 | N | Y | - | - | - | 13.5 | of a counter word |
| RU | D | 0.0 to 255.15 | 70 | 45 | 80 | 80 | N | Y | - | - | - | 23.0 | of a data word |
| RU | Ri | 0.0 to 255.15 | 70 | 47 | 80 | 80 | N | Y | - | - | - | 20.25 | of interface data area |

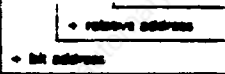

| | | | | | | | | | | | | | |
|----|---|----------------|----|----|---|---|---|---|---|---|---|------|--|
| S | = | Formal operand | 17 | 80 | - | - | N | Y | - | - | - | 38.5 | Set (binary) a formal operand |
| RB | = | Formal operand | 37 | 80 | - | - | N | Y | - | - | - | 38.5 | Reset (binary) a formal operand |
| . | = | Formal operand | 1F | 80 | - | - | N | Y | - | - | - | 38.5 | Assign the result of the logic operation to a formal operand |



Load and transfer operations (supplementary operations)

| Operation | Parameter | Machine code (hexadecimal) | | | | RLO dependent? | RLO (bits) | Condition codes affected? | | | Execution time (clock cycles) | Function |
|-----------|-----------|----------------------------|----|--------|----|----------------|------------|---------------------------|-----|----|-------------------------------|---|
| | | Word 0 | | Word 1 | | | | CC1 | CC0 | OV | | |
| | | B0 | B1 | B2 | B3 | | | | | | | |
| LIR *) | = 0 and 2 | 40 | 00 | | | N | N | - | - | - | 10.0 | Load accs 1 (LIR 0) or accs 2 (LIR 2) with the contents of the memory word addressed by accs 1. |
| TIR *) | = 0 and 2 | 40 | 00 | | | N | N | - | - | - | 9.0 | Transfer accs 2 to the memory word addressed by accs 1. |

*) System operation

* register address

| | | | | | | | | | | | | |
|----|------------------|----|----|---|---|---|---|---|---|---|-------|--|
| L | = Formal operand | 46 | 00 | - | - | N | N | - | - | - | 32.75 | Load a formal operand (Parameter type: I, Q, data type: BY, W). |
| LD | = Formal operand | 0E | 00 | - | - | N | N | - | - | - | 32.75 | Load a formal operand in BCD (Parameter type: T, C). |
| LW | = Formal operand | 3F | 00 | - | - | N | N | - | - | - | 19.5 | Load the bit pattern of a formal operand (Parameter type: D, data type: KF, KM, KM, KY, KS, KT, KC). |
| T | = Formal operand | 08 | 00 | - | - | N | N | - | - | - | 32.75 | Transfer to a formal operand (Parameter type: I, Q, data type: BY, W). |

* parameter address

| | | | | | | | | | | | | |
|---|-------------|----|----|---|---|---|---|---|---|---|-------|---|
| L | RS 0 to 255 | 62 | 00 | - | - | N | N | - | - | - | 13.0 | Load a word from the system data area |
| L | RI 0 to 255 | 6A | 00 | - | - | N | N | - | - | - | 13.0 | Load a word from the interface data area |
| T | RI 0 to 255 | 68 | 00 | - | - | N | N | - | - | - | 12.75 | Transfer to a word from the interface data area |

* relative address

Conversion functions (supplementary operations)

| | | | | | | | | | | | | |
|-----|--|----|----|---|---|---|---|---|---|---|------|--------------------------------|
| CFW | | 01 | 00 | - | - | N | N | - | - | - | 3.75 | One's complement (fixed-point) |
| CSW | | 09 | 00 | - | - | N | N | Y | Y | Y | 3.75 | Two's complement (fixed-point) |

Shift operations (supplementary operations)

| | | | | | | | | | | | | |
|-----|---------|----|----|---|---|---|---|---|---|---|----|-----------------------|
| SLW | 0 to 15 | 61 | 00 | - | - | N | N | Y | Y | - | 32 | Shift left (16 bits) |
| SRW | 0 to 15 | 69 | 00 | - | - | N | N | Y | Y | - | 32 | Shift right (16 bits) |

* number of shifts

Jump operations (supplementary operations)

| | | | | | | | | | | | | |
|----|--------------------|----|----|---|---|---|---|---|---|---|------|---|
| JJ | = Symbolic address | 2D | 00 | - | - | N | N | - | - | - | 7.25 | Unconditional jump |
| JC | = Symbolic address | FA | 00 | - | - | Y | Y | - | - | - | 6.0 | Conditional jump (Jump condition: RLO) |
| JZ | = Symbolic address | 46 | 00 | - | - | N | N | - | - | - | 6.5 | Conditional jump (Jump condition: CC1, CC0) |
| JN | = Symbolic address | 35 | 00 | - | - | N | N | - | - | - | 7.0 | Conditional jump (Jump condition: CC1, CC0) |
| JP | = Symbolic address | 15 | 00 | - | - | N | N | - | - | - | 7.0 | Conditional jump (Jump condition: CC1, CC0) |
| JM | = Symbolic address | 25 | 00 | - | - | N | N | - | - | - | 7.0 | Conditional jump (Jump condition: CC1, CC0) |
| JO | = Symbolic address | 0D | 00 | - | - | N | N | - | - | - | 6.5 | Conditional jump (Jump condition: OV) |

* jump displacement: 127

Other functions (supplementary operations)

| Operator | Parameter | Machine code (hexadecimal) | | | | R/D dependent? | R/D (bits) | Condition codes affected? | | | Execution time in instruction | Function | |
|---------------------|------------------|----------------------------|----|---------------------|----|----------------|------------|---------------------------|-----|----|-------------------------------|---|--|
| | | Word 0 | | Word 1 | | | | CC1 | CC0 | Ov | | | |
| | | B0 | B1 | B2 | B3 | | | | | | | | |
| BAF | | FE | 00 | - | - | Y | Y | - | - | - | 3,5 | Enable command output | |
| BAS | | BE | 00 | - | - | Y | Y | - | - | - | 3,5 | Disable command output | |
| RA | | 08 | 80 | - | - | N | N | - | - | - | 3,75 | Enable processing of process interrupt | |
| IA | | 08 | 00 | - | - | N | N | - | - | - | 3,75 | Disable processing of process interrupt | |
| D | 0 to 255 | 19 | 00 | - | - | N | N | - | - | - | 3,75 | Decrement | |
| I | 0 to 255 | 11 | 00 | - | - | N | N | - | - | - | 3,5 | Increment | |
| | | | | - value | | | | | | | | | |
| DO | = Formal operand | 76 | 00 | - | - | N | N | - | - | - | 32,8 | Process formal operand (parameter type B) | |
| | | | | - parameter address | | | | | | | | | |
| DC | DW 0 to 255 | 6E | 00 | - | - | N | N | - | - | - | 29,5 | Process data word | |
| | | | | - relative address | | | | | | | | | |
| DO | FX 0 to 255 | 4E | 00 | - | - | N | N | - | - | - | 20,0 | Process flag word | |
| | | | | - relative address | | | | | | | | | |
| TAR *) | | 70 | 02 | - | - | N | N | - | - | - | 5,0 | Swap the contents of accs 1 and accs 2 | |
| STS | | 70 | 0C | - | - | N | N | - | - | - | 4,25 | STOP | |
| *) System operation | | | | | | | | | | | | | |
| JL | 00 0 to 31 | 60 | 00 | - | - | N | Y | - | - | - | 42 | Unconditional organisation block call | |
| JC | 00 0 to 31 | 40 | 00 | - | - | Y | Y | - | - | - | 22 | Conditional organisation block call | |

Arithmetic operations (supplementary operations)

| Operator | Parameter | Machine code (hexadecimal) | | | | R/D dependent? | R/D (bits) | Condition codes affected? | | | Execution time in instruction | Function |
|----------|---------------------|----------------------------|----|----------------------|----|----------------|------------|---------------------------|-----|----|-------------------------------|---|
| | | Word 0 | | Word 1 | | | | CC1 | CC0 | Ov | | |
| | | B0 | B1 | B2 | B3 | | | | | | | |
| ADC | BF -128 to +127 | 50 | 00 | - | - | N | N | - | - | - | 3,75 | Add byte constant (fixed-point) to accs 1 |
| | | | | - constant (8 bits) | | | | | | | | |
| ADC | BF -32768 to +32768 | 56 | 00 | 00 | 00 | N | N | - | - | - | 7,0 | Add word constant (fixed-point) to accs 1 |
| | | | | - constant (16 bits) | | | | | | | | |

12 PC Program Correction through NC Operator Panel

12.1 Generalities

12.1.1 Using the PC Program Correction

12.1.2 Prerequisites and Activation of the Program Correction

12.1.3 Key functions

12.2 Operation

12.2.1 Basic Display

12.2.2 Up and Down Load of PC Program

12.2.3 PC Initial Clear

12.2.4 Editor

12.2.5 Search

12.2.6 Activation of Blocks Stored in PROMs

12.2.7 PC-RAM Compression

12.2.8 Information Functions

12.3 Examples of Use

12.3.1 Display of ISTACK at PC-Stop

12.3.2 Program Correction for Test Purposes

12.1 Generalities

12.1.1 Using the PC Program Correction

Functions of the programming unit 670/675 can be partially accomplished on the NC-operator panel, with the aid of the PC correction program (PC-diagnosis). With its use, small program corrections or error analysis (ISTACK, BSTACK) can be executed, especially during service.

The program correction can only be used with version 3; the NC software edition does not matter. When using the program correction, the changed user programs are stored in the free RAM memory of the PC. In the case of the 130 WA, care must be taken, that a free RAM range of 0.5k informations be present on the PC CPU for the user, and that it be used by user program.

The RAM memory on the PC CPU of the 130 WB is for 2.9k instructions.

12.1.2 Prerequisites and Activation

Test board 03220 must contain software "PC Program Correction" (10 EPROMs on PROM location 71-80).

The board must be plugged into the location next to the NC power supply.

Switch S3 on the NC-CPU board 03100 must be in lower position.

Switches Debug and Diagn on test board must be in upper position.

Switch NC ON.

The PC program correction is activated with the Diagn switch in lower position. The operator dialog is done via decision menus in text.

With active program correction, the PC program runs normally, but the NC software program is stopped.





















If the PC program correction is operated incorrectly, the NC-CPU can go to stop-state (red LED on board 03100 lights up).

Return into the PC program correction possible only with NC OFF/ON (hardware reset).

Jump of the PC program correction into normal NC software program: Diagn switch in upper position, then NC OFF/ON (hardware reset)

With the software "PC Program Correction", as described in section 10 of the start-up instructions, the NC engineering panel program is also available. It can be activated with the Debug switch.

12.1.3 Key Functions

| | | |
|---|---|---|
|  | Clear an input | |
|  | Enter an input | |
|  |  | Number range decimal 0-9 |
|  | Decimal-hexadecimal conversion | |
|  |  | Number range hexadecimal A-F |
|  | Input switch to hexadecimal numbers | |
|  | Minus sign | |
|  | Change of a datum | |
|  | Insertion of a datum | |
|  | Search for a datum | |
|  | Clearing of a datum | |
|  | Cursor 1 datum to the right | |
|  | Cursor 1 datum to the left | |
|  | Cursor 1 shift line down | |
|  | Cursor 1 shift line up.. | |
|  |  | Answer of questions for operator dialogue |
|  | Leaving the operating mode (not possible during inputs in editor operating mode) | |

12.2 Operation

12.2.1 Basic Display

```
LOAD PC PROGRAM
OUTPUT PC PROGRAM
ERASE PC
EDITOR
SEARCH
ACTIVATE EPROM BLOCKS
COMPRESS PC RAM
INFORMATION FUNCTIONS
```

Function selection by the operator is generally done with the keys YES and NO or ↑ and ↓

The display is switched to the next possible operation function with the NO key.

The YES key activates the selected operating mode.

12.2.2 Up and Down Load of PC Programs

Select the operating mode with operator dialogue YES and NO

CRT display:

READ-PUNCH COMBINATION
STANDARD READER
SELECT BAUD RATE

- Siemens PT 80 300 baud
- Siemens reader 9600 baud
- Baud rate selection:
150-300-600-1200-2400-4800-9600

PROGRAM BLOCK ?
FUNCTION BLOCK ?
ORGANIZATION BLOCK ?
DATA BLOCK ?
STEP BLOCK ?

- Selection through operator dialog YES and NO

INPUT BLOCK NUMBER....

- Entering with the key input

READY FOR INPUT
(OUTPUT)

Start with key YES

TRANSFER ACTIVE

The data are loaded up and down through the V-24 (RS232) interface of the NC.

TRANSFER FURTHER BLOCKS ?
(OUTPUT)

YES

NO

Select page block selection Select basic page

Remark: At the output of DB0, a list of the present blocks is outputted, similar to the "Output Director" with the PG 670.

12.2.3 PC Initial Clear

Select the operating mode through operator dialogue

BRING PC IN STOP STATE

PC switch to Stop position

"ERASE PC" NOT COMPLETED !

After approximately 3 seconds

"PC ERASE" COMPLETED
PC SWITCH:
2 times from STOP to OPERATION

Switch the PC switch 2 times from Stop to Operation, then select the basic page.

12.2.4 EditorFunction Range

- Input of a new block with type and number
- Search for an instruction in the PC memory range
- Search for an instruction in the selected program block
- Load into the active memory, and display the block on CRT
- Display of the STEP-5 codes of organization, step, function and program blocks
- Display of the corresponding data values for the data blocks
- Display of the blocks corresponding to the addresses in DBO
- Change, erase and search for a present code (hexadecimal, decimal and mixed), insertion of a new code
- Automatic correction of the datum, block length in the block header, and the jump address at erasing or insertion of a code, if the jump designation is present
- Retransfer into the PC RAM, and change the block address in the address list (DBO)

Read/Change Block

Select via operator dialogue in basic page

YES / NO

READ/CHANGE BLOCKS
ENTER NEW BLOCK

Read/change block

YES

BLOCK TYPE ?
PB PROGRAM BLOCK
SB STEP BLOCK
FB FUNCTION BLOCK
OB ORGANIZATION BLOCK
DB DATA BLOCK

Selection with

YES / NO

BLOCK NUMBER

Desired block number

with input key



(enter)

BLOCK NOT FOUND !
LEAVE "EDITOR" MODE ?

Selection with

 YES/ NO YES NO

Select basic page

Select editor block type

Block found, e.g. OB1

```

OB001  EPROM  FREE: 00364 WORDS
FFF6  7070  D001  8000  0000  0000
0000  86EF  98FB  99FB  3DOC  2D01
000A  3DC8  2D01  6500
0014
001E
0028
FFF6  7070
INPUT (H):

```

Cursor functions



The datum selected with the cursor
can be erased, changed, or a new datum
can be inserted
(see the key designation, section
12.1.3)

```

OB001  EPROM  FREE: 00364 WORDS
FFF6  7070  D001  8000  0000  0000
0000  86EF  98FB  99FB  3DOC  2D01
000A  3DC8  2D01  6500
0014
001E
0028
0000  86EF  AF  239.6
INPUT (H):

```

- Block header

AF239.6 = F251.0 = F251.1

JU FB12

JU FB200 BE

Display of the selected datum in
STEP-5 code

E.g. Change of datum 86EF (AF239.6) in AN F239.6

ANF = AD (see the instruction list PC 130W, section 11.8)

| | | |
|---|---|---------------------|
|  | Switch-over decimal/hexadecimal | Input (H): H |
|  | Hex-number A | Input (H): A |
|  | number 0 | Input (H): A0 |
|  | Switch-over hexadecimal/decimal | Input (D): A0 |
|  | number 2 | Input (D): A0.2 |
|  | number 3 | Input (D): A0.23 |
|  | number 9 | Input (D): A0.239 |
|  | Switch-over hexadecimal/decimal | Input (D): A0.239. |
|  | number 6 | Input (D): A0.239.6 |
|  | Termination of input, prior datum is changed | |
| | or | |
|  | newly entered datum is inserted | |
|  | Entered datum is searched for in the selected block | |
|  | Operating mode terminated | |

LEAVE "EDITOR" MODE ?

YES

NO

Call of block selected in operating mode editor

STORE BLOCK ?

YES

NO

Operating mode Editor is terminated.
The block is stored in the RAM memory of the PC. If, prior to this, the changed block was stored in EPROM, it will now automatically be activated in RAM (reactivation in the operating mode, 12.2.6)

Op. mode Editor is terminated.
The block is not stored!
The basic page is selected.

Entering a New Block

Operation is like in 12.2.4, block read/change

Exception: after the block number is entered, a library number must also be entered.

The block header of the new block is generated automatically.

Alarms: "RAM FULL"- the block cannot be stored.

Remedy: compress RAM

EPROM LIST FULL

12.2.5 Search

Select the operating mode via operator dialogue YES / NO

DATUM (H) SOUGHT



As in the Editor operating mode (12.2.4), the input of the sought for datum can be done in hexadecimal, decimal or mixed.

The input is completed with the Input key.

All valid blocks in the entire PC memory range are searched for the datum.

If the datum is found, e.g.

AF 239.6=86EF (instruction list see section 11.8)

0B001 EPROM FREE:00364 WORDS

```
FFF6 7070 D001 8000 0000 000D
0000 86EF 98EF 99FB 3D0C 2D01
000A 3DC8 2D01 6500
0000 86EF UM 239.6
```

If the datum is not found,

SEARCH COMPLETED
LEAVE "SEARCH" MODE

YES

NO

Select basic page

Select Search

DATUM FOUND! FURTHER SEARCH ?

YES

NO

The PC memory range is searched further for the desired datum

"EDITOR" MODE ?

YES

NO

Remark:
All blocks in the PC user program can be searched with code 6500 (BE).

Op. mode Editor is selected. All functions of Editor mode range are available (section 12.2.4)

Select basic page

12.2.6 Activation of Blocks Stored in PROMs

Select the operating mode via operator dialogue

YES / NO

OVERVIEW
SELECTION
LEAVE OPERATING MODE

Select

YES / NO

Overview YES

e.g. OB1 in EPROM and in RAM, RAM block valid

NUMBER BLOCKED EPROM BLOCKS
0 OB 01
PAGE OR INPUT NO

Page further

↑ / ↓

If the block is only present in EPROM,

NO EPROM BLOCK IN LIST

Select block type: YES

DB DATA BLOCK
PB PROGRAM BLOCK
FB FUNCTION BLOCK
OB ORGANIZATION BLOCK
SB STEP BLOCK

Select block

(e.g. PB1)

with

YES / NO

BLOCK TYPR: PB
BLOCK NUMBER 1

Input block number



Block locked

BLOCK TYPE: PB
BLOCK NUMBER 1
ENTER BLOCK

Block is not locked

BLOCK TYPE: PB
BLOCK NUMBER 1
BLOCK UNKNOWN

Exception: If a block stored in PROM was transferred into the RAM memory in the Editor operating mode, and if a hardware reset is executed afterwards, the block will no longer be entered into the EPROM list.

The block can no longer be generated in the "Activate PROM stored blocks" operating mode.

Remedy: Initial clear

12.2.7 Compress PC RAM

Select operating mode via operator dialogue

YES / NO

PC TO STOP STATE !

Push the PC switch from operation to stop

RAM ADDRESS LIMITS:

- * BEFORE COMPRESS
- * LOWEST USABLE E000
- * LOWEST USED E298
- * HIGHEST USABLE E3FF

START WITH YES !

at 130WA

C000
D616
D763

at 130WB

YES

NO

Basic page selection

RAM ADDRESS LIMITS:

- *AFTER COMPRESS
- *LOWEST USABLE
- *LOWEST USED
- *HIGHEST USABLE

TOTAL NUMBER OF BLOCKS FOUND
IN RAM

NUMBER OF FREE WORDS

OPERATING MODE ENDED !
ACKNOWLEDGE WITH YES !

YES

NO

Compression ended,
select basic page

Select "PC RAM Compress"
page

Switch the PC back to operation.

12.2.8 Information Functions

Select via operator dialogue

YES / NO

CONTROL BITS SD5-SD6-SD7
 READ I-STACK
 READ B-STACK
 READ PC ADDRESSES

Select

YES / NO

For explanations concerning control bits I-STACK, B-STACK, see section 11.6 .

When selecting "READ B-STACK", the depth can be incremented with page keys



READ PC ADDRESSES

YES

ENTER PC ADDRESS

e.g. MBO = PC address E E00
 (see PC address list, see section 11.8)
 E E00

HEXADECIMAL CODE
 BINARY CODE

Select

YES / NO

ADDRESS CONTENTS
 EE00 0110 1011 ACCESS - COUNTER 0001
 EE01 1001 0000 PC STATE
 OPERATION

Binary code

ADDRESS CONTENTS
 EE00 6890 ACCESS - COUNTER 0001
 EE01 0303 PC STATE
 OPERATION

Hexadecimal code

12.3 Application Examples

12.3.1 Reading the I-STACK during PC Stop.

The PC goes from normal operation to stop-state; the red PC LED lights.

Procedure:

PC switch to Stop

NC OFF

Board 03220 with program correction; plug EPROMs in.

Switch S3 on the front plate of the CPU in lower position

Diagnostic switch on board 03220 on lower position

NC ON (display shows CS = 7E00 IP = 00EC)

Press key **G**

Press key **LF** (the menu page of the PC program correction is displayed)

Select program test Information Function according to section 12.2.8

Read control bits, I-STACK, B-STACK.

12.3.2 Program Correction for Test Purposes



For testing of the spindle, in the following example the inputs and interlocks of the PC user program are "jumpered". In the example, the spindle enable and hold key on the machine control panel are used on input 11.6, respectively 11.7 .

Procedure:

- select operating mode "Editor"

- change block

- call OB1

- search for block end 
input 6500 

- cursor to the previous instruction

- input AI11.6 (spindle enable)

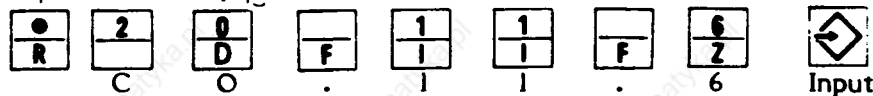

- set flag for the PC - NC interface SM4.3

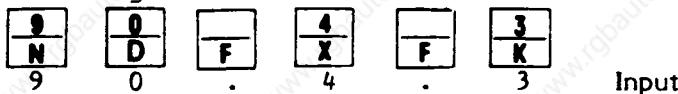

- input ANI11.7 (spindle hold)

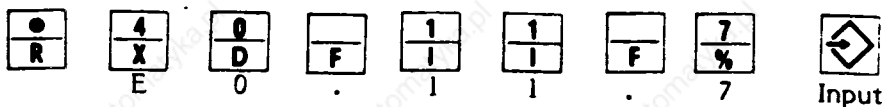

- Reset flag for the PC - NC interface RF 4.3



Input

- Terminate with the reset key



- Leave the EDITOR operating mode



- STORE the block



- The changed program is in the PC RAM

The changed OB1 can be cleared again, and the original block can later be activated again, with the operating modes:

PC initial clear

Activate the blocks in EPROM

13. Alarm Description

Contents

13.1 Generalities

13.2 Alarm List

13.3 Alarm Descriptions

13.1 Generalities

Alarm display for basic versions 0 and 2

| | | | | | | | | | | | | | | | | | | | | | | | | | | | | | | | | |
|---|---|---|---|---|---|---|---|-------|--------------|-------|----|----|----|----|----|----|----|----|----|----|----|----|----|----|----|----|----|----|----|----|----|----|
| | 1 | 2 | 3 | 4 | 5 | 6 | 7 | 8 | 9 | 10 | 11 | 12 | 13 | 14 | 15 | 16 | 17 | 18 | 19 | 20 | 21 | 22 | 23 | 24 | 25 | 26 | 27 | 28 | 29 | 30 | 31 | 32 |
| 1 | | | | 1 | | 1 | 0 | 1 | CLAMPING | CHECK | | | | | | | | | | | | | | | | | | | | | | |
| 2 | | | | | 5 | 0 | 4 | BLOCK | CONSTRUCTION | ∠ | | | | | | | | | | | | | | | | | | | | | | |
| 3 | A | L | A | R | M | | | | | | | | | | | | | | | | | | | | | | | | | | | |



The alarm light (nr. 4) can indicate one or several alarms.

The first alarm number of the NC's alarms is generally displayed in the last three columns of the 3rd. line. A maximum of 4 current alarms are displayed in text (brief description of cause), in two sequential pages.



Incrementing the display number with the page key to further possible alarms



(Display number, 1 resp. 2)

Alarm numbers 1 - 248 are monitors of the hardware and machine state (also of external devices).

Alarm numbers 250 - 718 are monitors for operation, programing, decoding and processing.



The alarm acts as E-stop, it brings the axes to an immediate standstill (locked control loop)



The alarm can only be cleared with PORESET (power-up)



The alarm can be cleared with the RESET key (with M30 at program end)



The alarm can be cleared with the CLEAR key. (input clear)

BA...

Refers to sections of the operator manual

Alarm List

| Clear | Hex.: | | 8 | 7 | 6 | 5 | 4 | 3 | 2 | 1 |
|-------|-------------------|---|--|------------------------|-----------------------------------|--------------------|--|------------------------|-----------------------|-------------------------|
| | 1. Decade | 2. Decade | Bit 7 | Bit 6 | Bit 5 | Bit 4 | Bit 3 | Bit 2 | Bit 1 | Bit 0 |
| // | 00 | | | | | Axis 1 | | | Axis 1 | Axis 1 |
| | 01 | | | | Moving axis disabled | Axis 2 | | | Axis 2 | Axis 2 |
| | 02 | | | Axis 3 | | | | Axis 3 | Axis 3 | |
| | 03 | | | Axis 4 | | | | Axis 4 | Axis 4 | |
| | 10 | Axis 1 | | Axis 1 | | Axis 1 | Axis 1 | Axis 1 | Axis 1 | |
| | 11 | Axis 2 | | Axis 2 | Axis 2 | Axis 2 | Axis 2 | Axis 2 | | |
| | 12 | Axis 3 | | Axis 3 | Axis 3 | Axis 3 | Axis 3 | Axis 3 | | |
| | 13 | Axis 4 | | Axis 4 | Axis 4 | Axis 4 | Axis 4 | Axis 4 | | |
| | 22 | Spindle encoder fault | | | | | Position control monitor of spindle *) | Emergency Stop | Control not ready | |
| | 23 | Time monitor V24 Interface | Overflow 2 Hardware Reader error | No stop-bit | Overflow | Parity | Control word transfer | Control word transfer | Overflow 1 | Stop-bit - parity error |
| | 24 | | | | | | | | Over-temperature | |
| | 25 | | Block w/o LF or with more than 120 charct. | | | | Operating error V24 interface | Parity error in memory | Program not in memory | Block not in memory |
| | 26 | | | | | | | | 1) | SNS block not found |
| 27 | Memory overflow | Discrepancy between memory and tape prog. | Tape format error | Tape input not allowed | Block with more than 120 charact. | Block parity error | Irrelevant EIA character | Character parity error | | |
| 28 | Sub-routine error | Cutter point error | | | | | | General decoding error | | |
| 29 | | False input parameter | False block order | False G02/G03 | False radius value | False angle value | No intersection | False input value | | |

Blueprint Prog. Error

*) can be cleared only with PORESET

Alarm List (continued)

| Clear ** | Nr.: 1. 2nd.Dec. | 3rd. Dec. | | 6 Bit 5 | 5 Bit 4 | 4 Bit 3 | 3 Bit 2 | 2 Bit 1 | 1 Bit 0 |
|-------------|------------------------|--|--------------------------------|-----------------------------------|---------------------------------------|-------------------------------------|------------------------------------|---|-------------------------------------|
| | | 8 Bit 7 | 7 Bit 6 | | | | | | |
| / | 30 | Circle end-point error | | | | Zero or tool off set value error | | Option not present | Circle not in selected plane |
| | 31 | | Too many axes to be driven | No F-word or too large | | Falsely programmed lead | | | |
| | 32 | | | | | | | Functions not allowed with selected CRC | |
| | 33 | | | | | | | | |
| | 34 | | | | | | | | |
| | 35 | | | | | | | | NC-start without ref.point |
| / | 50 | 2x axis, or more than 2 axes progr. rep.progr.f. | | CRC/ contour error | Blueprint programing error | False block structure | | More than 6 geometry parameters | General |
| | 51 | | | Complete block can't be displayed | Preselected block nr. cannot be found | Block with more than 120 characters | Memory overflow | Input inhibited | Input only in Reset-state |
| | 52 | Kv-factor not determined | Ky-factor of axes is not equal | | | | Hold at thread ¹⁾ | | Strobe-input error |
| | 53 | General input error | Last progr. not terminated | Only 2 axes allowed at playback | Playback only allowed at axes rest | Playback only when MDI interrupted | Playback in 1st. block not allowed | Program nr. already used | Block with more than 120 characters |
| MDA Error | | | | | | | | | |
| Restart | 70 | | | | | | | False address code in machine datum | |
| | 71 | | | | | | | | Battery alarm |

** Input line (lowest line) must be completely cleared.

Error 70X cannot be cleared with either RESET or CLEAR !

Error 71X can be cleared with CLEAR !

1) Alarm "Hold at Thread"

Versions 0 and 2 up to software 05

Alarm-Nr. 262

Version 3, software 01

13.3 Alarm Descriptions

| Alarm number | Description and Remedy |
|---------------------------------------|--|
| 1, 2, 11, 12, 21, 22, 31, 32 | <p data-bbox="426 399 673 428"><u>Limit Switches</u></p> <p data-bbox="426 444 1468 573">These alarms are also triggered when a software limit switch (value entered under TEST N160-N173) was reached (reference point dependent setting).</p> <p data-bbox="426 655 1508 739">The axis is stopped, but the position control loop remains closed and the following error moves the machine into position.</p> <p data-bbox="426 823 1463 909">In jog mode, the machine must be moved in the opposite direction, and the alarm must be cleared with the red reset key.</p> |
| 5, 15, | <p data-bbox="426 1106 964 1136"><u>A Moving Axis has been Disabled</u></p> <p data-bbox="426 1170 1517 1254">This alarm is issued if a "Control Enable" input signal was not received.</p> <p data-bbox="426 1338 1480 1422">All axes are brought to a rapid stop and the position control loop is locked (EMERGENCY STOP state).</p> <p data-bbox="426 1505 1463 1589">It should be investigated, why the interface has revoked the control enable (see Interface Test, section 8.1).</p> <p data-bbox="426 1673 1517 1764">The alarm is cleared with the red reset key; program restart is afterwards required.</p> |

| Alarm number | Description and Remedy |
|------------------------------|--|
| 101, 111, 121, 131, | <p data-bbox="345 282 646 315"><u>Standstill Monitor</u></p> <p data-bbox="345 331 1390 465">The standstill monitor is triggered when the set "Clamp Limit" has been exceeded, or if the axis failed to reach the position within the prescribed time interval.</p> <p data-bbox="345 521 607 555">Possible causes:</p> <ul data-bbox="345 589 1403 981" style="list-style-type: none"> <li data-bbox="345 589 1403 723">- An axis is pushed out of position due to high mechanical forces or faults in the control system, tacho generator, motor, mechanical portion, or the position control loop hardware. <li data-bbox="345 763 1369 842">- An axis cannot reach the position, e.g. because the drift is too high. <li data-bbox="345 882 1382 916">- A mechanically clamped axis has been pushed out of position. <li data-bbox="345 949 1073 983">- see the start-up manual, section 11, N353. <p data-bbox="326 1122 444 1155"><u>Remedy:</u></p> <ul data-bbox="326 1200 1403 1646" style="list-style-type: none"> <li data-bbox="326 1200 1313 1279">- The clamp limit TEST N110 - N113 must be higher than the position tolerance TEST N100 - N103. <li data-bbox="326 1357 1382 1491">- The "Dwell Time for Position Monitor" TEST N353 must be long enough to allow for the elimination of the following error within the prescribed time span. <li data-bbox="326 1565 1395 1646">- The axis is pushed out of position by more than allowed under TEST N110 - N113 (clamping), by another moving axis. |

| Alarm number | Description and Remedy |
|-----------------------------|--|
| 102, 112, 122, 132 | <p data-bbox="409 351 942 381"><u>Velocity Command Value too High</u></p> <p data-bbox="409 397 1491 534">is issued when the velocity command value generated in the control is higher than permitted under the "Command Value Limitation" set under TEST N354.</p> <p data-bbox="409 546 1491 633">This can occur when, for instance, the motor cannot follow the velocity command value (the maximum following error exceeded).</p> <p data-bbox="409 697 1491 782">Check whether the value set under TEST N354 is about 20% higher than the "Command Value Limitation" set under N140 - N143.</p> |
| 103, 113, 123, 133 | <p data-bbox="409 943 668 973"><u>Contour Monitor</u></p> <p data-bbox="409 989 1491 1177">This monitor triggers alarms 103...133, and the servos are stopped by dropping the velocity command value to \emptyset. Also, the enable signals for velocity control are revoked, and the machine is switched to follow-up mode.</p> <p data-bbox="409 1196 1127 1226">The alarms are cleared with the reset key.</p> <p data-bbox="409 1290 1491 1478">Alarms 103...133 indicate, that the velocity control loop optimization is inadequate, or that the position loop gain is too high - as would certainly be the case if the values set under TEST N351 and N352 are zeroes.</p> <p data-bbox="409 1542 1491 1740">Alarms 103...133 are triggered if the tolerance band set under N352 is exceeded, or when, during accelerations and decelerations of the drive, the axis does not reach the new speed within the K_v dependent time limit.</p> |

| Alarm number | Description and Remedy |
|-----------------------------|---|
| 104, 114, 124, 134 | <p data-bbox="332 280 950 313"><u>Position Control Loop Hardware Fault</u></p> <p data-bbox="332 324 1339 470">The monitor trigger if the position control cable breaks, if the position control signals are missing, or if a ground short occurred..</p> <p data-bbox="332 526 1372 616">Alarm activation leads to an immediate standstill of all axes (see the start-up manual section 11, N353).</p> <p data-bbox="332 649 893 683">Check the position control cable.</p> |
| 10C 115, 125, 135 | <p data-bbox="332 806 576 840"><u>Drift too High</u></p> <p data-bbox="332 851 1388 996">As long as the drift (temperature influences on components) is not too high, the control is able to compensate for it (BA 8.6.5).</p> <p data-bbox="332 1052 1404 1142">The alarms are triggered if the drift becomes larger than about 500 mV.</p> <p data-bbox="332 1209 1404 1444">The "Not in Position" LED does not go out if the position control loop or the drive are not ready. It also remains lit in the following cases: the servo drive is inhibited, there is a hardware fault in the position control loop or servo drive, or the drift for the drive is not properly adjusted.</p> <p data-bbox="332 1500 1404 1590">Execute the "drift compensation" again (service manual, section 5.5).</p> <p data-bbox="332 1601 1266 1646">(The drift memory is displayed under TEST N230 - N233.)</p> |

| Alarm number | Description and Remedy |
|-----------------------------|---|
| 108, 118, 128, 138 | <p><u>Contaminated Scales</u></p> <p>When linear scales are used by the measuring system, when the scales are contaminated, the alarm is triggered by a hardware signal from EXE (see the Interface Description, chapter 7) to the NC.</p> |
| 222 | <p><u>Control Loop Not Ready (Position Control - Input Signal)</u></p> <p>This alarm indicates a fault in the servo drive unit. It indicates if the appropriate input signal "Velocity Control Ready" (collective signal for all axes) is connected, and one drive unit is defective (e.g. fuse blown, overheating, etc).</p> <p>The alarm brings about a rapid stop of the feed drive; the "Control Loop Ready" signal is revoked.</p> <p>Insert the P-N jumper "Servo Ready Simulation", if the signal is not being used by the interface (see service manual, sec. 9).</p> |
| 223 | <p><u>EMERGENCY STOP (E-STOP)</u></p> <p>is issued in the presence of the E-STOP interface input signal.</p> <p>Check whether the E-STOP key was inadvertently pressed, or whether the machine moved to an emergency-stop cam.</p> <p>(Interface test nr. 8, byte 5, bit 7 = "0" , * E-STOP is present)</p> <p>The alarm brings the axes to a stop and inhibits the control.</p> |

| Alarm number | Description and Remedy |
|--------------|---|
| 224 | <p data-bbox="393 320 943 353"><u>Spindle Position Control Monitor</u></p> <p data-bbox="393 371 943 405">Hardware monitor for the spindle</p> <p data-bbox="393 421 1493 454">It only is active when N407, bit 2 = 1 (spindle encoder present)</p> <p data-bbox="393 506 1438 589">This signal is issued when the input signals A, A*, B, B*, Z, and Z* are faulty or missing.</p> <p data-bbox="393 640 1058 674">The alarm brings the spindle to a stop.</p> <p data-bbox="393 745 1438 831">The corresponding signals must always be of opposite polarity (e.g. $A \neq A^*$).</p> |
| 228 | <p data-bbox="393 1003 888 1037"><u>Spindle Encoder Contamination</u></p> <p data-bbox="393 1055 918 1088">not implemented at the present.</p> <p data-bbox="393 1140 1174 1173">ROD encoders have no contamination indicators.</p> <p data-bbox="393 1245 1389 1328"><u>Only</u> for encoders with EXE 600/601 (linear systems, alarms 108...138).</p> |

| Alarm number | Description and Remedy |
|-----------------------------|--|
| 231, 232, 233, 237 | <p>These alarms only react if the Siemens tape reader is used.</p> <p>Causes:</p> <ul style="list-style-type: none"> - reader electronic board MS600, for 232 and 233 especially - reader for 231, 237 - machine datum, in case of alarm 231 |
| 234 | <p><u>Parity Fault</u></p> <p>This alarm can occur only if machine datum 411 or 412 bit 4 is set.</p> <p>The alarm is triggered when the data word from the reader (8 bit information + 1 parity bit) has wrong parity.</p> <p>This fault is totally unrelated to parity errors of ISO or EIA characters of the tape (see alarm 271).</p> <p>Check the machine data and external device.</p> |
| 235 | <p><u>Overflow Error</u></p> <p>This alarm is triggered when the control receives a new character before it could store the previous character.</p> <ul style="list-style-type: none"> - Check machine data and external devices - Error in USART interface - Cable |
| 236 | <p><u>Stop-Bit Error</u></p> <p>The alarm is issued when the wrong number of stop-bits have been set.</p> <p>Check the machine data and external devices.</p> |

| Alarm number | Description and Remedy |
|--------------|--|
| 238 | <p data-bbox="394 303 1070 331"><u>Time Monitor for V24 (RS232C) Interface</u></p> <p data-bbox="394 353 1361 435">This alarm is triggered if the NC is unable to output or receive a character within 20 seconds.</p> <p data-bbox="394 480 513 508">Causes:</p> <ul data-bbox="394 530 1410 712" style="list-style-type: none"><li data-bbox="394 530 997 557">- External device is not powered up<li data-bbox="394 580 893 607">- Incorrectly connected cable<li data-bbox="394 630 1410 712">- The external device blocks the CTS signal for longer than 20 seconds. <p data-bbox="394 766 1443 902">The alarm is also issued when the control signals (DC1 - DC4) are used and the NC receives no DC1 (11 H) within 20 seconds at data output.</p> |
| 242 | <p data-bbox="394 1084 654 1111"><u>Overtemperature</u></p> <p data-bbox="394 1152 1427 1233">This alarm is triggered if the temperature on the components reaches the limit temperature of 50°C.</p> <p data-bbox="394 1279 1460 1406">When this occurs, the NC Ready 1 signal is revoked. The interface then revokes the read enable, i.e. only the currently active block is processed to the end.</p> <p data-bbox="394 1451 888 1478">Check the fans and air ducts.</p> <p data-bbox="394 1551 1460 1632">If the internal temperature of the control is lower than 56°C, check the temperature switch on the CPU.</p> <p data-bbox="394 1687 1460 1714">The trigger temperature range of switch S2 on the CPU is 56°C.</p> |

| Alarm number | Description and Remedy |
|--------------|--|
| 251 | <u>Block not Found in Memory</u> e.g. when jumping to a block number. |
| 252 | <u>Program not Found in Memory</u> The selected part program cannot be found in memory. |
| 253 | <u>Parity Error in Memory</u> |
| 254 | <u>Operating Error for V24 Interface (RS232 C)</u> <ul style="list-style-type: none">- NC operating mode Data Output and Data Start from the PC- V24 (RS232) lock is on, and Data Start from the PC or operator panel- The code for Siemens reader is set in machine datum 412 |
| 257 | <u>Block Missing LF or Containing more than 120 Characters</u> or M02, M30 without LF |
| 261 | <u>No Coincidence Found during Sequence Number Search (SNS)</u> The alarm is triggered during SNS if the sought for block or subroutine cannot be found up to the end of the program, i.e. the object of the search (block or subroutine) is not present in the program memory. |

| Alarm number | Description and Remedy |
|--------------|---|
| 262 | <p><u>Fault at Thread</u></p> <p>This alarm indicates to the operator, that an interruption occurred during thread cutting, resulting in damage to the thread (hold in feed per revolution).</p> <p>For versions 0 and 2, starting with software edition 06.</p> <p>For version 3 starting with software edition 02, this is displayed as alarm 523.</p> |
| 271 | <p><u>Character Parity Error</u></p> <p>Depending on the program start definition - "%" or "EOR" - the control automatically recognizes the code as ISO or EIA according to this character.</p> <p>From this point on, the parity of all following characters is checked; it must correspond to the established parity. Alarm 271 is triggered if disparity is found.</p> <p>EIA is odd parity. ISO is even parity.</p> |
| 272 | <p><u>Inadmissable Hole Combination of an EIA Character</u></p> <p>Alarm is issued despite correct parity, if a character is undefined in EIA code and it has been read.</p> |
| 273 | <p><u>Block Parity Error</u></p> <p>When the block parity monitor (setting datum) is activated, all the characters of a block are counted. If the sum is not an even number, alarm 273 is triggered.</p> <p>The control always generates tapes with even block parity, independently of the setting datum; for this purpose, if needed, blanks will be issued.</p> |

| Alarm number | Description and Remedy |
|--------------|--|
| 274 | <p data-bbox="398 312 1004 344"><u>Block with more than 120 Characters</u></p> <p data-bbox="398 358 1480 548">If a block with more than 120 characters is read, alarm 274 is issued. Only the stored characters are counted, i.e. CR, sprockets, spaces (blanks) with the exception of comments, are not counted.</p> <p data-bbox="398 585 1153 623">Remedy: brake the block into several blocks.</p> |
| 275 | <p data-bbox="398 743 730 775"><u>Tape Input Disabled</u></p> <p data-bbox="398 789 862 827">Alarm 275 is triggered if :</p> <ul data-bbox="398 857 1480 1183" style="list-style-type: none"><li data-bbox="398 857 1480 1054">a) The memory lock is in the "off" position during an attempt to read a part program or subroutine from tape, setting datum "Key switch active during input of part programs" being set.<li data-bbox="398 1084 1480 1183">b) The data safety switch S1 on the CPU is not in "free" (upper) position during down-loading of machine data "TE". |
| 276 | <p data-bbox="398 1297 697 1329"><u>Tape Format Error</u></p> <p data-bbox="398 1365 895 1403">Alarm 276 is triggered when :</p> <ul data-bbox="398 1433 1480 1793" style="list-style-type: none"><li data-bbox="398 1433 1480 1524">a) The allowed number of decades following an address is incorrect.<li data-bbox="398 1560 1242 1598">b) A decimal point appears in the wrong position.<li data-bbox="398 1628 1480 1719">c) Part programs or subroutines are terminated or incorrectly defined.<li data-bbox="398 1750 1308 1789">d) False format for the clearing of programs is used. |

| Alarm number | Description and Remedy |
|--------------|---|
| 277 | <p><u>Stored Program ≠ Tape Program</u></p> <p>If a tape is read more than once, its content is compared block by block to the program stored during the first reading. The alarm 277 is triggered if any disparities are found.</p> <p>This alarm is also issued at any attempt to store a program under a program number, under which another program has already been stored.</p> <p>In such cases, the previously stored program must be cleared.</p> <p>Unlike during storage of programs, when programs are compared the "Available Memory" number remains unchanged.</p> |
| 278 | <p><u>Memory Overflow</u></p> <p>If the memory space becomes insufficient during down-loading, alarm 278 is triggered.</p> <p>The memory space still available for storage can be checked via the "Available Memory" number.</p> <p>If necessary, irrelevant programs may be erased and the program must be read anew.</p> |
| 281 | <p><u>Irreparable Programing Errors</u></p> <p><u>General</u></p> <p>The error is displayed in the "Display of the Correction Block" page, with an additional comma underneath each character.</p> |

| Alarm number | Description and Remedy |
|--------------|---|
| 287 | <p data-bbox="365 313 795 347"><u>Path Intersection Error</u></p> <p data-bbox="365 358 1458 459">The alarm is triggered at errors in the programing of the stock removal cycle L94, when the parameters entered are false.</p> |
| 288 | <p data-bbox="365 571 641 604"><u>Subroutine Error</u></p> <ul data-bbox="365 616 795 716" style="list-style-type: none">- M17 in part program- Excessive nesting depth |
| 291 | <p data-bbox="365 873 885 907"><u>Errors in Blueprint Programing</u></p> <p data-bbox="365 974 657 1008"><u>False Input Value</u></p> <p data-bbox="365 1019 1458 1120">The programed values lead to overflow during calculation, or cannot be calculated due to false dimensions or procedure.</p> |

| Alarm number | Description and Remedy |
|--------------|---|
| 292 | <u>No Intersection</u> When calculating the elements of the described contour, the programmed values fail to result in an intersection. |
| 293 | <u>False Angle Value</u> Alarm indicates angles larger or equal to 360° , or value unreasonable for the described contour. |
| 294 | <u>False Radius Value</u> The input value is too large or inadmissible for the described contour. |
| 295 | <u>False G02/G03</u> Circular direction is not possible for the described contour. |
| 296 | <u>False Block Sequence</u> Several blocks are necessary for calculations : The sequence is incompatible, or there is insufficient information for the calculation. |
| 297 | <u>False Input Parameters</u> The programmed parameter sequence is inadmissible or incomplete in view of the described contour. |

| Alarm number | Description and Remedy |
|--------------|---|
| 301 | <p><u>Circle not in the Selected Plane</u></p> <p>3M: the interpolation parameters are incorrect for the selected plane.</p> |
| 302 | <p><u>Non-existent Option</u></p> <p>This alarm is issued under the following circumstances:</p> <ul style="list-style-type: none"> - Option "Feed per Revolution" is not present, <u>and</u> G95/G96 is programmed - Option "Thread" is not present <u>and</u> G33 is programmed <p>Remedy: Check software extent and machine data</p> |
| 304 | <p><u>Zero Offset or Tool Offset: Inadmissible Value</u></p> <p>Double word overflow is possible with six or more decade values.</p> |
| 308 | <p><u>Circle End-point Error</u></p> <p>The programmed circle end-point lies outside the circle. The alarm is triggered when the end-point lies outside the tolerance specified by the machine datum N355 ("Circle End-point Monitor").</p> |
| 314 | <p><u>Thread Lead Incorrectly Programed</u></p> <p>The thread lead is programmed under I, J, <u>or</u> K, and <u>always</u> refers to the <u>leading</u> axis, because alarm 314 is otherwise triggered.</p> <p>(e.g. X 20 000 Z 10 000 K 1000)</p> |

| Alarm number | Description and Remedy |
|--------------|--|
| 316 | <u>F-word not Programed</u> E.g. no F yet in program or programed at feed per revolution. |
| 317 | <u>Two many Axes Programed</u> This alarm is issued when more than two axes should move, as would be the case with G41/G42. |
| 322 | <u>Inadmissable Block at CRC resp. TRC</u> With a selected CRC or TRC, G92, G33, M19 or G59 may not be programed. Remedy: Program G40 or G41/G42, D00 (CRC cancelled) |
| 351 | <u>NC Start without Reference Point</u> |

| Alarm number | Description and Remedy |
|--------------|---|
| 501 | <p>ALARMS 501...538 CAN BE CLEARED WITH THE CLEAR KEY</p> <p><u>Reparable Programing Errors</u></p> <p><u>General</u></p> <p>The error is indicated in the "Display of the Correction Block" page (block before decoding), with an additional characteristic.</p> |
| 502 | <p><u>More than 6 Geometry Parameters</u></p> <p>are programed in one block.</p> <p>(Geometry parameters are: axes, interpolation parameters, radii, angles)</p> |
| 504 | <p><u>False Block Structure</u></p> <p>E.g. N10 G02 X1000 LF (missing interpolation parameters) N20 G02 Z2000 I20 LF (I20 not allowed in this block)</p> |
| 505 | <p><u>Error in Blueprint Programing</u></p> |
| 506 | <p><u>CRC resp. TRC Contour Error</u></p> <p>The intermediate block is too small for the selected offset, or the travelling direction resulting from the offset calculation is opposite to that programed.</p> |
| 508 | <p><u>Axis Programed Twice or more than 2 Axes Programed</u></p> |

| Alarm number | Description and Remedy |
|--------------|--|
| 511 | <p><u>Input only in Reset State</u></p> <p>The alarm is issued if inadmissible functions are selected in automatic mode. These functions can be employed only if the reset key is first pressed.</p> <p>The alarm can be cleared with the  key.</p> |
| 512 | <p><u>Input Inhibited</u></p> <p>Input is only possible if the key switch is in "open" position or if the S1 data safety switch on the CPU 03 100 is in upper position.</p> <p>The alarm is also triggered if input is attempted in the wrong operating mode.</p> |
| 513 | <p><u>Memory Overflow</u></p> <p>This alarm indicates that the program memory is full. Programs not in current use may have to be erased (see BA 7.1). These procedures can be undertaken only while the control is in reset state.</p> |
| 514 | <p><u>Block with more than 120 Characters</u></p> <p>During editing, the number of characters in a block is checked before storing. (The 120 characters must include LF)</p> <p>The only remedy is to split the large block into several smaller ones.</p> |

| Alarm number | Description and Remedy |
|--------------|---|
| 515 | <p><u>Selected Block Number not Found</u></p> <p>This alarm indicates that the selected block number cannot be found in the program during SNS.</p> <p>The cursor is set to the program start and the program is displayed.</p> |
| 516 | <p><u>Block cannot be Displayed in Its Entirety</u></p> <p>Even if the allowed block length was not exceeded (120 characters), in certain configurations , not all the characters can be displayed.</p> <p>Remedy: It is possible to generate two blocks (the second of which has no block number), by inserting an "LF".</p> <p>The two blocks can now be changed, so that a functional program can be produced.</p> |
| 521 | <p><u>Error at Strobe Input</u></p> <p>This alarm is triggered at external data input if the code is wrong, the word is too long, or %input is made during a running program.</p> |
| 523 | <p><u>Hold at Thread</u> (see alarm nr. 262)</p> |
| 527 | <p><u>Unequal Kv Factors of the Axes</u></p> <p>The alarm is issued if the computed Kv factors of the axes are not equal, because this inequality can lead to contour deviations.</p> |
| 528 | <p><u>Kv Factors not Calculated</u></p> <p>Occurs as a remainder after power-up and machine data change.</p> |

| Alarm number | Description and Remedy |
|--------------|---|
| | <u>MDA Alarms</u> |
| 531 | <u>Block with more than 40 Characters</u> |
| 532 | <u>Program Number already in Memory</u> |
| 533 | <u>Playback Inadmissible as First Block</u> A program number must first be opened in teach-in mode, and it must be correctly stored. |
| 534 | <u>Playback only Allowed if MDA is Interrupted</u> An additional block must be stored in MDA. |
| 535 | <u>Playback only Allowed when the Axes are Stopped</u> No axis motion may take place while the block is being stored. |
| 536 | <u>More than 2 Axes in a Block</u> More than two axes cannot interpolate. |

| Alarm number | Description and Remedy |
|--------------|--|
| 537 | <p><u>Last Program not Terminated</u> appears as a warning when a new program is opened under MDA, before the old program has been terminated.</p> |
| 538 | <p><u>General Input Error in MDA</u></p> |
| 702 | <p><u>False Address Code in Machine Datum</u> Machine data must be changed. (Name, axis.)</p> |
| 711 | <p><u>Battery Alarm</u></p> <p>Check the voltage of the battery on 03500 (power supply); if necessary, change the battery.</p> <p><u>Important :</u> The battery must be exchanged under voltage (while the control is powered up), so that the C-MOS Memory 03210, resp. 03260, is not erased.</p> <p><u>Note :</u> In version 2 (with PC), when the battery fails the PC goes into stop state, and thus the NC also stops. The alarm is therefore not triggered under these circumstances (see the service manual, section 3.3.12).</p> |

14 Basic Version 0 Brief Start-up Instructions

Contents

- 14.1 Prerequisites
- 14.2 Setting the Standard Machine Data
- 14.3 Adaption to the Machine
- 14.4 Adaptions of the Velocity Related Machine Data Before the First Travel
- 14.5 Setting the Control Sense for the Axes
- 14.6 Moving the Axes
- 14.7 Functional Adaptions
- 14.8 Remarks Concerning Erroneous Inputs and Erasing the Memory Ranges
- 14.9 Conclusion
- 14.10 List 1: Axis Specific Machine Data
- 14.11 List 2: Common Machine Data
- 14.12 List 3: Machine Data Bits
- 14.13 List 4: Possible Devices for Data Input and Output

14.1 Prerequisites

- Check
- 24 V input voltage on power supply 03500 (+24 V, 0 V)
 - 24 V input voltage on operator panel (+24 V, 0 V)
 - 24 V input voltage on machine control panel (+24 V, 0 V)



The position control cables (command and actual value cables) should be unplugged.



The tacho should be adjusted for maximum velocity according to 8 V velocity command value.

Check on the installation of position control boards 03310 and 03320.

14.2 Setting the Standard Machine Data

Operating mode  MDI-SE-TE

3T: key  and  both keys pressed simultaneously,

3M: key  and  NC power-up

14.3 Adaptions to the Machine

Only machine data whose adaption to the machine is absolutely necessary are handled. For standard values, maximum values and units, see lists 1 and 2.

Operating mode  MDI-SE-TE

Upper position for the switch on board 03100, select  Test

Input e.g. >160  Input figures 0..9

e.g. >403  figures 0.1

↑
Cursor

If the machine's output system is in inch (ball screw, position coder, machine data), see the start-up instructions in section 11.4 .

14.4 Adaptions of the Velocity Related Machine Data, before the First Travel

In the presence of deviations from the standard values, the input of machine related values is required.

14.4.1 Maximum Axis Velocity Standard: 10000 mm/min

| | | | |
|--|--|--------------|--|
|  3T >130 S... |  X-axis | 3M >130 S... | X-axis |
| >131 S... |  Z-axis | >131 S... |  Y-axis |
| | | >132 S... | Z-axis |

14.4.2 Software Limit Switch Standard: limit switch inactive, + direction

| | | | |
|--|--|--------------|--|
|  3T >160 S... |  X-axis | 3M >160 S... | X-axis |
| >161 S... |  Z-axis | >161 S... |  Y-axis |
| | | >162 S... | Z-axis |

Minus Direction

| | | | |
|--|--|--------------|--|
|  3T >170 S... |  X-axis | 3M >170 S... | X-axis |
| >171 S... |  Z-axis | >171 S... |  Y-axis |
| | | >172 S... | Z-axis |

14.4.3 Reference Point Values Standard: 0

When the reference point is approached, the reference point value is transferred into the actual value.

| | | | |
|--|--|--------------|--|
|  3T >180 S... |  X-axis | 3M >180 S... | X-axis |
| >181 S... |  Z-axis | >181 S... |  Y-axis |
| | | >182 S... | Z-axis |

14.4.4 Velocity Adaption Standard: 8 V, command value = 10000 mm/min maximum axis velocity at 8 V command value

| V max (m/min) at 8 V command value | 15 | 12 | 10 | 8 | 6 | 5 | 4 | 3 | 1 |
|--|------|------|------|------|------|------|------|------|-------|
| Input Value | 1600 | 2000 | 2400 | 3000 | 4000 | 4800 | 6000 | 8000 | 12000 |

| | | | |
|--|--|--------------|--|
|  3T >220 S... |  X-axis | 3M >220 S... | X-axis |
| >221 S... |  Z-axis | >221 S... |  Y-axis |
| | | >222 S... | Z-axis |

14.4.5 Operating Mode Dependent Velocities Standard, List 2



 > 371 through > 375

14.4.6 Maximum Speeds for Gear Ranges Standard List 2

 > 359 through > 366 gear ranges 1 through 8

14.5 Setting the Control Sense for the Axes



Plug in the actual value cable.

| | | | | |
|---|--|---|---|---|
| Travel direction of the axes | + | | + | |
| According to polarity of the speed command value of the drive | + | | - | |
| Move axis in + direction, actual value is in display |  | |  | |
| Set bit 1 to : | 0 | 1 | 1 | 0 |
| Set bit 2 to : | 0 | 1 | 0 | 1 |

Standard

21 bit

Nr. 403 through 405 S _____

 3T >403 S...  X-axis 3M >403 S... X-axis
 >404 S... Z-axis >404 S...  Y-axis
 >405 S... Z-axis

14.6 Moving the Axes

Plug in all the cables! The following signals must be present: Control Enable, Feed Release, No Emergency Stop, No Axis Lock (check via the interface diagnosis, see the operator manual).

14.6.1 Drift Compensation

see the operator manual section 8.6.5 . The value is entered automatically in  nr. 230 through 232.

14.6.2 Adaption of Travel Distance to Command Distance

Move 10 mm in operating mode "Increment" 

The distance travelled by the axis is :

| | 10 mm | 20 mm | 5 mm |
|-------|-------|-------|------|
| Bit 3 | 0 | 1 | 0 |
| Bit 4 | 0 | 0 | 1 |

↑
Standard

43 Bit

Nr. 403 through 405 S_____



3T >403 S...

>404 S...



X-axis

X-axis

3M >403 S...

>404 S...

>405 S...



X-axis

Y-axis

Z-axis

14.7 Functional Adaptions

14.7.1 Hand Wheel Activation



>408 S 00.01001

bit 5 to 1



14.7.2 Device Coding for Data Input/Output Standard: unit with 300 baud and 2 stop bits

For the adaption of other devices, see list 4.



>411 S_____

>412 S_____



Data Input

Data Output

14.7.3 Functional Options

Individual bits according to start-up list or control data sheet.

14.7.4 Automatic Determination of the Position Loop Gain (K_V Factor)

Move each axis in manual mode   , JOG, 100%, for about 4 seconds.

The calculated K_V factor is displayed under test  nr. 850 - 852.

In continuous path control, the values of the participating axes must be equal. Any deviation of more than 50 leads to alarm 827. In such cases, all the K_V values entered as machine data nr. 150 - 152, or the tacho adjustment or machine data 220 through 223 are wrong.

The K_V factors are cleared each time the machine data are changed.





14.8 Remarks

The machine can be optimized exactly by following the extensive instructions given in the "Service Manual SINUMERIK System 3".

The input of erroneous machine data may lead to activation of the red LED on board 03100; in such cases, return to section 14.2 .

If power supply 03501 is disconnected, the battery voltage will be lost.

The following cancel operations are necessary for the reactivation of the control:

| | | |
|---|---|--------------------|
|  |  | Clear Machine Data |
| |  | Clear User Program |
| |  | Clear Setting Data |

The NC should be powered, and the cancel and number keys should be pressed simultaneously.

The machine data must then be entered anew.

14.9 Conclusion

The toggle switch on board 03100 should be in lower position.

Generate a machine data list and/or machine data tape and place it next to the control.

Test all functions of the machine and all operating modes.

14.10 List 1 : Axis Specific Machine Data

| Nr. | Standard values set with "Input" | Axis | Entered values 3T | Axis | Entered values 3M | Explanation | Maximum value [unit] |
|-----|----------------------------------|------|-------------------|------|-------------------|-----------------------------|----------------------------------|
| 100 | 50 | X | | X | | Position tolerance | 32000 [μm] |
| 101 | 50 | Z | | Y | | | |
| 102 | 50 | | / | Y | | | |
| 103 | 50 | | / | X | | | |
| 110 | 200 | X | | X | | Clamp limit | 32000 [μm] |
| 111 | 200 | Z | | Y | | | |
| 112 | 200 | | / | Z | | | |
| 113 | 200 | | / | X | | | |
| 120 | 50 | X | | X | | Acceleration | 6000 [0.01m/s^2] |
| 121 | 50 | Z | | Y | | | |
| 122 | 50 | | / | Z | | | |
| 123 | 50 | | / | X | | | |
| 130 | 10000 | X | | X | | Max:Velocity | 15000 [mm/min] |
| 131 | 10000 | Z | | Y | | | |
| 132 | 10000 | | / | Z | | | |
| 133 | 10000 | | / | X | | | |
| 140 | 2048 | X | | X | | Velocity command limitation | 2048 [VEL0] |
| 141 | 2048 | Z | | Y | | | |
| 142 | 2048 | | / | Z | | | |
| 143 | 2048 | | / | X | | | |
| 150 | 1666 | X | | X | | K_V factor | 10000 [0.01s^{-1}] |
| 151 | 1666 | Z | | Y | | | |
| 152 | 1666 | | / | Z | | | |
| 153 | 1666 | | / | X | | | |
| 160 | +9999999 | X | | X | | Limit switch + | +9999999 [μm] |
| 161 | +9999999 | Z | | Y | | | |
| 162 | +9999999 | | / | Z | | | |
| 163 | +9999999 | | / | X | | | |
| 170 | -9999999 | X | | X | | Limit switch - (minus) | -9999999 [μm] |
| 171 | -9999999 | Z | | Y | | | |
| 172 | -9999999 | | / | Z | | | |
| 173 | -9999999 | | / | X | | | |
| 180 | 0 | X | | X | | Reference point | +9999999 [μm] |
| 181 | 0 | Z | | Y | | | |
| 182 | 0 | | / | Z | | | |
| 183 | 0 | | / | X | | | |
| 190 | 0 | X | | X | | Backlash compensation | ±255 [μm] |
| 191 | 0 | Z | | Y | | | |
| 192 | 0 | | / | Z | | | |
| 193 | 0 | | / | X | | | |
| 210 | 0 | X | | X | | Reference point shift | ±9999 [μm] |
| 211 | 0 | Z | | Y | | | |
| 212 | 0 | | / | Z | | | |
| 213 | 0 | | / | X | | | |
| 220 | 2400 | X | | X | | Mult gain | 32000 [CXmin/m] |
| 221 | 2400 | Z | | Y | | | |
| 222 | 2400 | | / | Z | | | |
| 223 | 2400 | | / | X | | | |
| 230 | 0 | X | | X | | Drift compensation | ±500 [VEL0] |
| 231 | 0 | Z | | Y | | | |
| 232 | 0 | | / | Z | | | |
| 233 | 0 | | / | X | | | |

14.11 List 2: Common Machine Data

| Nr. | Standard data set via "Input" | Input values 3T | Input values 3M | Explanations | Max. Value [units] |
|-----|-------------------------------|-----------------|-----------------|---------------------------------|-------------------------------|
| 350 | 500 | | | Cut-off velocity | 15000 [mm/min] |
| 351 | 0 | | | Threshold for contour mon. | [mm/min] |
| 352 | 0 | | | Contour tolerance | 32000 [mm.Test850 / 725.1000] |
| 353 | 500 | | | Dwell time for position monit. | 16000 [ms] |
| 354 | 2400 | | | Velocity comm. value limit | 3000 [VELO] |
| 355 | 10 | | | Circle end-pt. monitor | 32000 [µm] |
| 356 | 10 | | | Compensation motion limit | 32000 [µm] |
| 357 | 0 | | | Spindle drift | ± 500 [VELO] |
| 358 | 0 | | | Thread dynamic smoothing exp. | 5 |
| 359 | 500 | | | Maximum speed for 8 gear ranges | 9999 [r/min] |
| 360 | 1000 | | | | |
| 361 | 2000 | | | | |
| 362 | 4000 | | | | |
| 363 | 4000 | | | | |
| 364 | 4000 | | | | |
| 365 | 4000 | | | | |
| 366 | 4000 | | | | |
| 371 | 2000 | | | Manual feed | 15000 [mm/min] |
| 372 | 10000 | | | Man.rapid trav. | |
| 373 | 10000 | | | Ref.appr.vel. | |
| 374 | 500 | | | INC speed | |
| 375 | 2000 | | | DRY feed | |
| 376 | 1000 | | | Dwell time for spindle inhibit | 16000 [ms] |
| 377 | 0 | | | Minimum spindle motor speed | 2048 [VELO] |
| 381 | | | | Software edition | 3200 |
| 385 | -9999999 | | | 2nd.limit switch X- | ±9999999 [µm] |

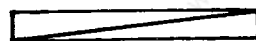

Values are meaningless; value can be ∅ or set value.

14.12 List 3: Machine Data Bits

Standard values set
with "Input"

Enter the set values
(do not change preset values)

3T

| Nr. | Machine Data Bits | | | | | | | |
|--------|-------------------|---|---|---|---|---|---|---|
| | 7 | 6 | 5 | 4 | 3 | 2 | 1 | 0 |
| N 400S | 1 | 1 | 1 | 1 | 0 | 1 | 0 | 0 |
| N 401S | 1 | 1 | 1 | 1 | 0 | 0 | 1 | 1 |
| N 402S | 1 | 1 | 1 | 1 | 0 | 0 | 0 | 0 |
| N 403S | 0 | 0 | 0 | 0 | 0 | 0 | 0 | 0 |
| N 404S | 0 | 0 | 0 | 0 | 0 | 0 | 0 | 0 |
| N 405S | 0 | 0 | 0 | 0 | 0 | 0 | 0 | 0 |
| N 406S | 0 | 0 | 0 | 0 | 0 | 0 | 0 | 0 |
| N 407S | 0 | 0 | 0 | 0 | 0 | 1 | 0 | 0 |
| N 408S | 0 | 0 | 0 | 0 | 1 | 0 | 0 | 1 |
| N 409S | 1 | 0 | 1 | 0 | 0 | 1 | 0 | 0 |
| N 410S | 1 | 1 | 1 | 1 | 1 | 1 | 1 | 1 |
| N 411S | 1 | 1 | 0 | 0 | 0 | 0 | 0 | 0 |
| N 412S | 1 | 1 | 0 | 0 | 0 | 0 | 0 | 0 |
| N 413S | 0 | 0 | 0 | 0 | 0 | 0 | 0 | 0 |
| N 414S | 0 | 0 | 0 | 0 | 0 | 0 | 0 | 0 |
| N 415S | 1 | 0 | 1 | 0 | 1 | 0 | 1 | 0 |
| N 416S | 0 | 0 | 0 | 0 | 0 | 0 | 1 | 1 |
| N 417S | 0 | 0 | 0 | 0 | 0 | 0 | 0 | 0 |

3T

| Nr. | Machine Data Bits | | | | | | | |
|--------|-------------------|---|---|---|---|---|---|---|
| | 7 | 6 | 5 | 4 | 3 | 2 | 1 | 0 |
| N 400S | | | | | | | | |
| N 401S | | | | | | | | |
| N 402S | | | | | 0 | 0 | 0 | 0 |
| N 403S | 0 | 0 | 0 | | | | | |
| N 404S | 0 | 0 | 0 | | | | | |
| N 405S | 0 | 0 | 0 | 0 | 0 | 0 | 0 | 0 |
| N 406S | 0 | 0 | 0 | 0 | 0 | 0 | 0 | 0 |
| N 407S | | 0 | 0 | 0 | 0 | | | |
| N 408S | | | 0 | | 1 | | | |
| N 409S | 1 | 0 | | | 0 | | 0 | |
| N 410S | | | | | | | | |
| N 411S | | | | | | | | |
| N 412S | | | | | | | | |
| N 413S | | | | | | | | |
| N 414S | 0 | 0 | 0 | 0 | 0 | 0 | 0 | 0 |
| N 415S | 1 | 0 | 1 | | 1 | | 1 | |
| N 416S | | | 0 | 0 | 0 | 1 | 1 | 1 |
| N 426S | 0 | 0 | 0 | | | | 0 | |

3M

| Nr. | Bit | | | | | | | |
|--------|-----|---|---|---|---|---|---|---|
| | 7 | 6 | 5 | 4 | 3 | 2 | 1 | 0 |
| N 400S | 1 | 1 | 1 | 1 | 1 | 0 | 1 | 1 |
| N 401S | 1 | 1 | 1 | 1 | 0 | 0 | 1 | 1 |
| N 402S | 1 | 1 | 1 | 1 | 0 | 1 | 1 | 0 |
| N 403S | 0 | 0 | 0 | 0 | 0 | 0 | 0 | 0 |
| N 404S | 0 | 0 | 0 | 0 | 0 | 0 | 0 | 0 |
| N 405S | 0 | 0 | 0 | 0 | 0 | 0 | 0 | 0 |
| N 406S | 0 | 0 | 0 | 0 | 0 | 0 | 0 | 0 |
| N 407S | 0 | 0 | 0 | 0 | 0 | 0 | 0 | 0 |
| N 408S | 0 | 0 | 0 | 0 | 1 | 0 | 0 | 1 |
| N 409S | 1 | 0 | 0 | 0 | 0 | 0 | 0 | 0 |
| N 410S | 1 | 1 | 1 | 1 | 1 | 1 | 1 | 1 |
| N 411S | 1 | 1 | 0 | 0 | 0 | 0 | 0 | 0 |
| N 412S | 1 | 1 | 0 | 0 | 0 | 0 | 0 | 0 |
| N 413S | 0 | 0 | 0 | 0 | 0 | 0 | 0 | 0 |
| N 414S | 0 | 0 | 0 | 0 | 0 | 0 | 0 | 0 |
| N 415S | 1 | 0 | 0 | 0 | 1 | 0 | 0 | 0 |
| N 416S | 0 | 0 | 0 | 0 | 0 | 0 | 1 | 1 |
| N 417S | 0 | 0 | 0 | 0 | 0 | 0 | 0 | 0 |

3M

| Nr. | Bit | | | | | | | |
|--------|-----|---|---|---|---|---|---|---|
| | 7 | 6 | 5 | 4 | 3 | 2 | 1 | 0 |
| N 400S | | | | | | | | |
| N 401S | | | | | | | | |
| N 402S | | | | | 0 | 0 | 0 | 0 |
| N 403S | 0 | 0 | 0 | | | | | |
| N 404S | 0 | 0 | 0 | | | | | |
| N 405S | 0 | 0 | 0 | | | | | |
| N 406S | 0 | 0 | 0 | 0 | 0 | 0 | 0 | 0 |
| N 407S | | 0 | 0 | 0 | 0 | 0 | 0 | 0 |
| N 408S | | | 0 | | 1 | | | |
| N 409S | 1 | 0 | | | 0 | 0 | 0 | 0 |
| N 410S | | | | | | | | |
| N 411S | | | | | | | | |
| N 412S | | | | | | | | |
| N 413S | | | | | | | | |
| N 414S | | 0 | 0 | 0 | 0 | 0 | | |
| N 415S | 1 | 0 | | 0 | 1 | | | |
| N 416S | | 0 | 0 | 0 | 0 | 1 | 1 | 1 |
| N 417S | 0 | 0 | 0 | | | 0 | 0 | |

See section 2.1

14.13 List 4: Possible Devices for Data Input and Output (Selection)

| Bit | | | | | | | | Hexa | Designation | Baud rate | Type |
|-----|---|---|---|---|---|---|---|------|-----------------------|-----------|-----------------|
| 7 | 6 | 5 | 4 | 3 | 2 | 1 | 0 | | | | |
| 0 | 0 | 0 | 0 | 1 | 1 | 1 | 1 | 0 F | Siemens reader | 9600 | Special devices |
| 0 | 0 | 0 | 1 | 1 | 0 | 0 | 0 | C 0 | TELETYPE ASR 33 * | 110 | Universal units |
| 1 | 1 | 0 | 0 | 0 | 0 | 1 | 0 | C 2 | SIEMENS PT80 | 300 | |
| 1 | 1 | 0 | 0 | 0 | 0 | 1 | 1 | C 3 | FACIT 4040 | 600 | |
| 1 | 1 | 0 | 0 | 0 | 0 | 1 | 1 | C 3 | FACIT 4070 with M177 | 600 | |
| 1 | 1 | 0 | 0 | 0 | 1 | 0 | 0 | C 4 | FACIT 4030 | 1200 | |
| 1 | 1 | 0 | 0 | 0 | 1 | 0 | 0 | C 4 | SANYO M2502U | 1200 | |
| 1 | 1 | 0 | 0 | 1 | 1 | 0 | 0 | C C | FACIT 420E (cassette) | 1200 | |
| 0 | 0 | 0 | 0 | 0 | 0 | 0 | 0 | 0 0 | ** | | |



* For teletype in software edition 04, 05, enter: 1100000.

** From software edition 06
Output : PT80 (300 baud)
Input: Siemens reader