

Pegasus





Contact blocks

Spring loaded Terminals

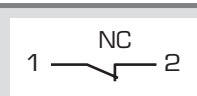

AUTOMATION TECHNOLOGIES

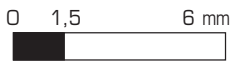
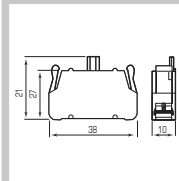
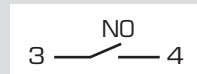
SPRING LOADED TERMINALS

		CONTACT BLOCKS			
DESIGNATION	FUNCTIONS	CODE	DIMENSIONS		
				PCW01	
				PCW10	

LAMPHOLDER BA9s

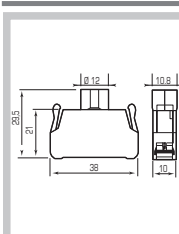
DESIGNATION	POWER SUPPLY	CODE	DIMENSIONS
	 <p>BA9s lamp socket 250V 2,4 w max bulb not included</p>	PCWAD	

LAMPHOLDER WITH BUILT-IN LED

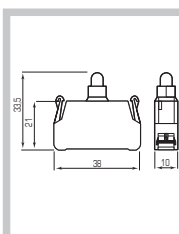
DESIGNATION	POWER SUPPLY	CODE	DIMENSIONS
	AC/DC 12V	PCW5L12	
	AC/DC 24V	PCW5L24	
	AC/DC 48V	PCW5L48	
	AC/DC 110V	PCW5L110	
	AC 220V	PCW5L220	

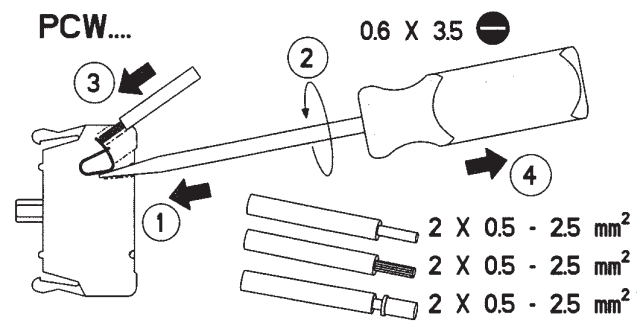
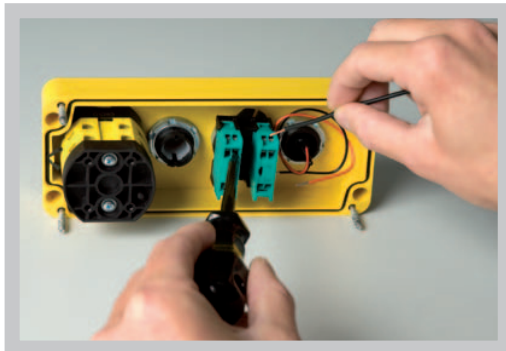



Pegasus

Contact blocks

Welding terminals

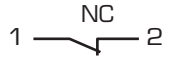
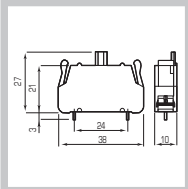
CONTACT BLOCKS

CONTACT BLOCKS				
DESIGNATION	FUNCTIONS	CODE	DIMENSIONS	
 <p>NC 1 — 2</p>	<p>0 1,5 6 mm</p> 	PSC01		
<p>NO 3 — 4</p>	<p>0 3,5 6 mm</p> 	PSC10		

LAMPHOLDER BA9s

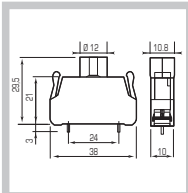
DESIGNATION	POWER SUPPLY	CODE	DIMENSIONS
 <p>X1 — X2</p>	<p>BA9s lamp socket 250V 2,4 w max bulb not included</p>	PSCAD	

LAMPHOLDER WITH BUILT-IN LED

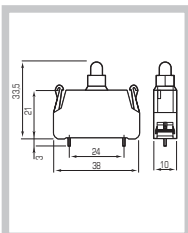
DESIGNATION	POWER SUPPLY	CODE	DIMENSIONS
 <p>X1 — X2</p>	AC/DC 12V	PSC5L12	
	AC/DC 24V	PSC5L24	
	AC/DC 48V	PSC5L48	
	AC/DC 110V	PSC5L110	
	AC 220V	PSC5L220	

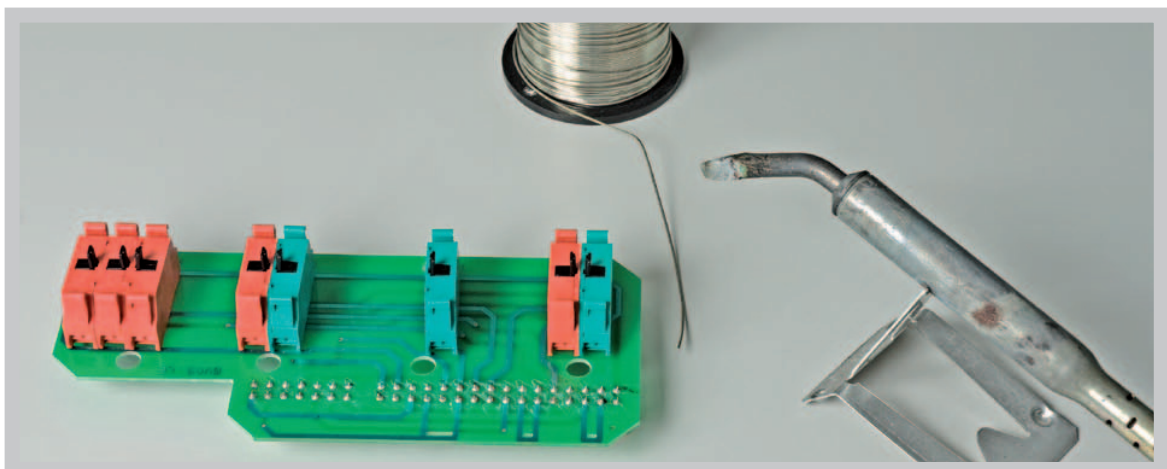

Pegasus



Contact blocks

Screw terminals



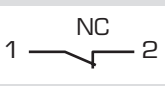

AUTOMATION TECHNOLOGIES

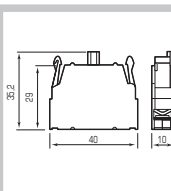
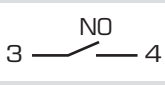
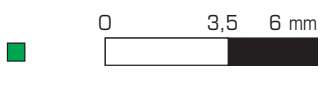
CONTACT BLOCKS

		CONTACT BLOCKS				
DESIGNATION	FUNCTIONS	CODE	DIMENSIONS			
			PL004001			
			PL004002			

LAMPHOLDER BA9s

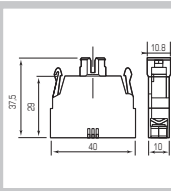

DESIGNATION	POWER SUPPLY	CODE	DIMENSIONS
	 <p>BA9s lamp socket 250V 2,4 w max bulb not included</p>	PL004007	

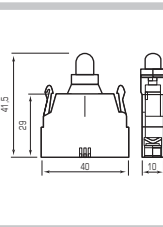
LAMPHOLDER WITH BUILT-IN LED

DESIGNATION	POWER SUPPLY	CODE	DIMENSIONS
	AC/DC 12V	PL0045L12	
	AC/DC 24V	PL0045L24	
	AC/DC 48V	PL0045L48	
	AC/DC 110V	PL0045L110	
	AC 220V	PL0045L220	

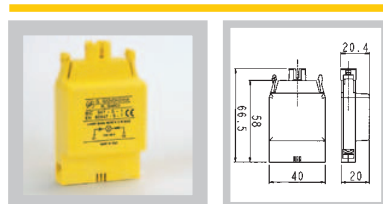
POWER SUPPLY WITH DIODE AND RESISTORS



DESIGNATION	POWER SUPPLY	CODE
1 BA9s Lamp 4B/60V -2W max 	110/130V	PL004RD1
	220/240V Lamp 110/130V -2W max	PL004RD2

POWER SUPPLY WITH TRANSFORMER

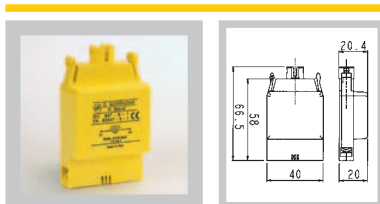

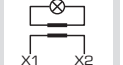
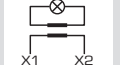
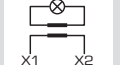
DESIGNATION	POWER SUPPLY	CODE
1 BA9s 	Input 110/130V Output 24V	PL004TR1
	Input 220/240V Output 24V	PL004TR2
	Input 380/440V Output 24V	PL004TR3

POWER SUPPLY WITH FLASHING LIGHT

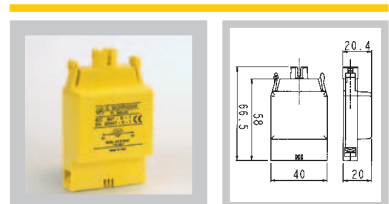

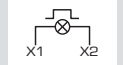
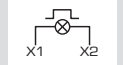
DESIGNATION	POWER SUPPLY	CODE
1 BA9s 	24V Lamp 24V-2,6 max	PL004LA1
	110/130V 110/130V-2,6 max	PL004LA2

1 Lamp supply separately