

**SYSMAC  
CPM1**

**Programmable Controllers**

**OPERATION MANUAL**

**OMRON**

# CPM1 Programmable Controllers

## Operation Manual

Revised February 1998

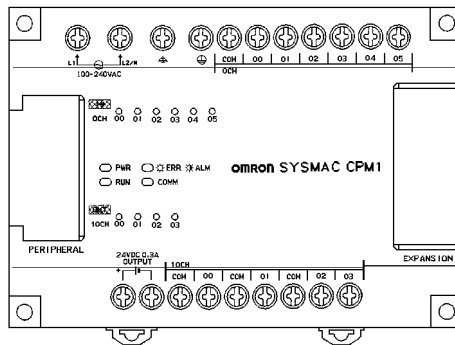

## Notice:

OMRON products are manufactured for use according to proper procedures by a qualified operator and only for the purposes described in this manual.

The following conventions are used to indicate and classify precautions in this manual. Always heed the information provided with them. Failure to heed precautions can result in injury to people or damage to property.



### **DANGER**

Indicates an imminently hazardous situation which, if not avoided, will result in death or serious injury.



### **WARNING**

Indicates a potentially hazardous situation which, if not avoided, could result in death or serious injury.



### **Caution**

Indicates a potentially hazardous situation which, if not avoided, may result in minor or moderate injury, or property damage.

## OMRON Product References

All OMRON products are capitalized in this manual. The word "Unit" is also capitalized when it refers to an OMRON product, regardless of whether or not it appears in the proper name of the product.

The abbreviation "Ch," which appears in some displays and on some OMRON products, often means "word" and is abbreviated "Wd" in documentation in this sense.

The abbreviation "PC" means Programmable Controller and is not used as an abbreviation for anything else.

## Visual Aids

The following headings appear in the left column of the manual to help you locate different types of information.

**Note** Indicates information of particular interest for efficient and convenient operation of the product.

**1, 2, 3...** 1. Indicates lists of one sort or another, such as procedures, checklists, etc.

## © OMRON, 1995

All rights reserved. No part of this publication may be reproduced, stored in a retrieval system, or transmitted, in any form, or by any means, mechanical, electronic, photocopying, recording, or otherwise, without the prior written permission of OMRON.

No patent liability is assumed with respect to the use of the information contained herein. Moreover, because OMRON is constantly striving to improve its high-quality products, the information contained in this manual is subject to change without notice. Every precaution has been taken in the preparation of this manual. Nevertheless, OMRON assumes no responsibility for errors or omissions. Neither is any liability assumed for damages resulting from the use of the information contained in this publication.

# TABLE OF CONTENTS

<b>PRECAUTIONS</b> .....	<b>xi</b>
1 Intended Audience .....	xii
2 General Precautions .....	xii
3 Safety Precautions .....	xii
4 Operating Environment Precautions .....	xiii
5 Application Precautions .....	xiii
<b>SECTION 1</b>	
<b>Introduction</b> .....	<b>1</b>
1-1 CPM1 Features and Functions .....	2
1-2 System Configuration .....	8
1-3 Revised Specifications .....	14
<b>SECTION 2</b>	
<b>Unit Specifications and Components</b> .....	<b>15</b>
2-1 Specifications .....	16
2-2 Unit Components .....	22
<b>SECTION 3</b>	
<b>Installation and Wiring</b> .....	<b>27</b>
3-1 Design Precautions .....	28
3-2 Selecting an Installation Site .....	29
3-3 Installing the CPM1 .....	30
3-4 Wiring and Connections .....	34
<b>SECTION 4</b>	
<b>Using Peripheral Devices</b> .....	<b>47</b>
4-1 Support Software Capabilities .....	48
4-2 Using a Programming Console .....	55
4-3 Programming Console Operations .....	59
4-4 Programming Example .....	78
<b>SECTION 5</b>	
<b>Test Runs and Error Processing</b> .....	<b>85</b>
5-1 Initial System Checks and Test Run Procedure .....	86
5-2 The CPM1 Cycle .....	88
5-3 Self-diagnosis Functions .....	89
5-4 Programming Console Operation Errors .....	91
5-5 Programming Errors .....	91
5-6 Troubleshooting Flowcharts .....	93
5-7 Maintenance Inspections .....	101
5-8 Handling Precautions .....	102
<b>Appendices</b>	
A Standard Models .....	103
B Dimensions .....	105
<b>Glossary</b> .....	<b>111</b>
<b>Index</b> .....	<b>127</b>
<b>Revision History</b> .....	<b>131</b>

## About this Manual:

The CPM1 is a compact, high-speed Programmable Controller (PC) designed for control operations in systems requiring from 10 to 50 I/O points per PC. There are two manuals describing the setup and operation of the CPM1: the *CPM1 Operation Manual* (this manual) and the *CQM1/CPM1/CPM1A/SRM1 Programming Manual*.

This manual describes the system configuration and installation of the CPM1 and provides a basic explanation of operating procedures for the Programming Consoles and introduces the capabilities of the SYSMAC Support Software (SSS). Read this manual first to acquaint yourself with the CPM1.

The *CQM1/CPM1/CPM1A/SRM1 Programming Manual (W228)* provides detailed descriptions of the CPM1's programming functions. The *SYSMAC Support Software Operation Manual: C-series PCs* provides descriptions of SSS operations for the CPM1 and C-series PCs. The *SYSMAC-CPT Support Software Quick Start Guide (W332)* and *User Manual (W333)* provide descriptions of ladder diagram operations in the Windows environment.

Please read this manual carefully and be sure you understand the information provided before attempting to install and operate the CPM1.

**Section 1** gives a brief overview of the steps involved in developing of a CPM1 System, describes the possible system configurations, and describes the CPM1's special features and functions.

**Section 2** provides the technical specifications of the Units that go together to create a CPM1 PC and describes the main components of the Units.

**Section 3** describes how to install and wire a CPM1 PC.

**Section 4** describes SSS capabilities, how to connect the Programming Console, and how to perform the various Programming Console operations.

**Section 5** describes how to perform a test run and how to diagnose and correct the hardware and software errors that can occur during PC operation.

**Appendix A** provides tables of CPM1 Units and related products.

**Appendix B** provides the dimensions of CPM1 Units.



### **WARNING**

Failure to read and understand the information provided in this manual may result in personal injury or death, damage to the product, or product failure. Please read each section in its entirety and be sure you understand the information provided in the section and related sections before attempting any of the procedures or operations given.

# PRECAUTIONS

This section provides general precautions for using the Programmable Controller (PC) and related devices.

**The information contained in this section is important for the safe and reliable application of the Programmable Controller. You must read this section and understand the information contained before attempting to set up or operate a PC system.**

1 Intended Audience .....	xii
2 General Precautions .....	xii
3 Safety Precautions .....	xii
4 Operating Environment Precautions .....	xiii
5 Application Precautions .....	xiii

## 1 Intended Audience

This manual is intended for the following personnel, who must also have knowledge of electrical systems (an electrical engineer or the equivalent).

- Personnel in charge of installing FA systems.
- Personnel in charge of designing FA systems.
- Personnel in charge of managing FA systems and facilities.

## 2 General Precautions

The user must operate the product according to the performance specifications described in the operation manuals.

Before using the product under conditions which are not described in the manual or applying the product to nuclear control systems, railroad systems, aviation systems, vehicles, combustion systems, medical equipment, amusement machines, safety equipment, and other systems, machines, and equipment that may have a serious influence on lives and property if used improperly, consult your OMRON representative.

Make sure that the ratings and performance characteristics of the product are sufficient for the systems, machines, and equipment, and be sure to provide the systems, machines, and equipment with double safety mechanisms.

This manual provides information for programming and operating the Unit. Be sure to read this manual before attempting to use the Unit and keep this manual close at hand for reference during operation.

 **WARNING** It is extremely important that a PC and all PC Units be used for the specified purpose and under the specified conditions, especially in applications that can directly or indirectly affect human life. You must consult with your OMRON representative before applying a PC System to the above-mentioned applications.

## 3 Safety Precautions

 **WARNING** Do not attempt to take any Unit apart while the power is being supplied. Doing so may result in electric shock.

 **WARNING** Do not touch any of the terminals or terminal blocks while the power is being supplied. Doing so may result in electric shock.



 **WARNING** Do not attempt to disassemble, repair, or modify any Units. Any attempt to do so may result in malfunction, fire, or electric shock.

 **Caution** Execute online edit only after confirming that no adverse effects will be caused by extending the cycle time. Otherwise, the input signals may not be readable.

 **Caution** Confirm safety at the destination node before transferring a program to another node or changing the I/O memory area. Doing either of these without confirming safety may result in injury.



 **Caution** Tighten the screws on the terminal block of the AC Power Supply Unit to the torque specified in the operation manual. The loose screws may result in burning or malfunction.

## 4 Operating Environment Precautions

-  **Caution** Do not operate the control system in the following places:
- Locations subject to direct sunlight.
  - Locations subject to temperatures or humidity outside the range specified in the specifications.
  - Locations subject to condensation as the result of severe changes in temperature.
  - Locations subject to corrosive or flammable gases.
  - Locations subject to dust (especially iron dust) or salts.
  - Locations subject to exposure to water, oil, or chemicals.
  - Locations subject to shock or vibration.
-  **Caution** Take appropriate and sufficient countermeasures when installing systems in the following locations:
- Locations subject to static electricity or other forms of noise.
  - Locations subject to strong electromagnetic fields.
  - Locations subject to possible exposure to radioactivity.
  - Locations close to power supplies.
-  **Caution** The operating environment of the PC System can have a large effect on the longevity and reliability of the system. Improper operating environments can lead to malfunction, failure, and other unforeseeable problems with the PC System. Be sure that the operating environment is within the specified conditions at installation and remains within the specified conditions during the life of the system.

## 5 Application Precautions

Observe the following precautions when using the PC System.

-  **WARNING** Always heed these precautions. Failure to abide by the following precautions could lead to serious or possibly fatal injury.
- Always connect to a class-3 ground (to 100  $\Omega$  or less) when installing the Units. Not connecting to a class-3 ground may result in electric shock.
  - Always turn off the power supply to the PC before attempting any of the following. Not turning off the power supply may result in malfunction or electric shock.
    - Mounting or dismounting I/O Units, CPU Units, Memory Cassettes, or any other Units.
    - Assembling the Units.
    - Setting DIP switches or rotary switches.
    - Connecting or wiring the cables.
    - Connecting or disconnecting the connectors.
-  **Caution** Failure to abide by the following precautions could lead to faulty operation of the PC or the system, or could damage the PC or PC Units. Always heed these precautions.
- Fail-safe measures must be taken by the customer to ensure safety in the event of incorrect, missing, or abnormal signals caused by broken signal lines, momentary power interruptions, or other causes.



- Interlock circuits, limit circuits, and similar safety measures in external circuits (i.e., not in the Programmable Controller) must be provided by the customer.
- Always use the power supply voltage specified in the operation manuals. An incorrect voltage may result in malfunction or burning.
- Take appropriate measures to ensure that the specified power with the rated voltage and frequency is supplied. Be particularly careful in places where the power supply is unstable. An incorrect power supply may result in malfunction.
- Install external breakers and take other safety measures against short-circuiting in external wiring. Insufficient safety measures against short-circuiting may result in burning.
- Do not apply voltages to the Input Units in excess of the rated input voltage. Excess voltages may result in burning.
- Do not apply voltages or connect loads to the Output Units in excess of the maximum switching capacity. Excess voltage or loads may result in burning.
- Disconnect the functional ground terminal when performing withstand voltage tests. Not disconnecting the functional ground terminal may result in burning.
- Install the Unit properly as specified in the operation manual. Improper installation of the Unit may result in malfunction.
- Be sure that all the mounting screws, terminal screws, and cable connector screws are tightened to the torque specified in the relevant manuals. Incorrect tightening torque may result in malfunction.
- Leave the label attached to the Unit when wiring. Removing the label may result in malfunction.
- Remove the label after the completion of wiring to ensure proper heat dissipation. Leaving the label attached may result in malfunction.
- Use crimp terminals for wiring. Do not connect bare stranded wires directly to terminals. Connection of bare stranded wires may result in burning.
- Double-check all the wiring before turning on the power supply. Incorrect wiring may result in burning.
- Mount the Unit only after checking the terminal block completely.
- Be sure that the terminal blocks, Memory Units, expansion cables, and other items with locking devices are properly locked into place. Improper locking may result in malfunction.
- Check the user program for proper execution before actually running it on the Unit. Not checking the program may result in an unexpected operation.
- Confirm that no adverse effect will occur in the system before attempting any of the following. Not doing so may result in an unexpected operation.
  - Changing the operating mode of the PC.
  - Force-setting/force-resetting any bit in memory.
  - Changing the present value of any word or any set value in memory.
- Resume operation only after transferring to the new CPU Unit the contents of the DM and HR Areas required for resuming operation. Not doing so may result in an unexpected operation.
- Do not pull on the cables or bend the cables beyond their natural limit. Doing either of these may break the cables.
- Do not place objects on top of the cables. Doing so may break the cables.
- When replacing parts, be sure to confirm that the rating of a new part is correct. Not doing so may result in malfunction or burning.
- Before touching the Unit, be sure to first touch a grounded metallic object in order to discharge any static built-up. Not doing so may result in malfunction or damage.

- Do not touch the Expansion I/O Unit Connecting Cable while the power is being supplied in order to prevent any malfunction due to static electricity.

**⚠ Caution** Always clear memory before beginning to program the CPM1. Although memory is cleared before the CPU Unit is shipped (except for bits with specific functions), AR 1314, which turns ON when the internal capacitor cannot back up memory, may have turned ON during shipment.

**⚠ Caution** If the CPM1 will be turned off for periods exceeding the data backup period of the internal capacitor, design the system so that it will not be influenced if data in the DM, HR, and CNT areas is cleared when power is turned off.

**⚠ Caution** Either switch the CPM1 to RUN or MONITOR mode, or turn off and on power to the CPM1 after changing from a Programming Device any data that is backed up in flash memory. This data includes the user program, read-only DM area (DM 6144 to DM 6599), and the PC Setup (DM 6600 to DM 6655).

- The user program and memory area data in the CPM1 are backed up either by an internal capacitor or in flash memory as shown in the following table.

Backup method	Data
Internal capacitor	Read/write DM area (DM 0000 to DM 0999, DM 1022, and DM 1023) Error log area (DM 1000 to DM 1021) HR area (HR 00 to HR 19) Counter area (CNT 000 to CNT 127)
Flash memory	User program Read-only DM area (DM 6144 to DM 6599) PC Setup (DM 6600 to DM 6655)

- Note**
1. The IR, TR, LR, and timer areas are not normally backed up when power is turned off and all contents will be cleared the next time power is turned on. (The PC Setup setting in DM 6601 can be used to back up this data. Refer to details on the PC Setup later in this manual for details.)
  2. The bits in the AR and SR areas have special functions and are set according to these functions when power is turned on.
- The capacitor backup time depends on the ambient temperature, as shown in the following graph. The backup time, however, assumes that the capacitor is fully charged, which requires that power be supplied to the CPU Unit continuously for at least 15 minutes.

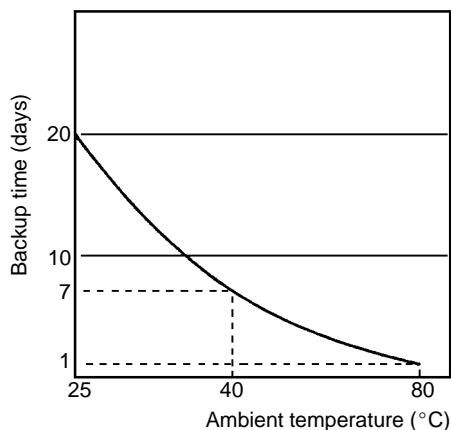

If the power remains off for a period exceeding the data backup period, AR 1314 will turn ON to indicate that the capacitor can no longer back up data and the data backed up by the capacitor will be cleared. AR 1314 will remain ON unless it is turned OFF using I/O monitor operations, using memory clear operations, or from the user program.

If desired, the PC Setup setting in DM 6604 can be set to create a fatal error and thus stop the system when AR 1314 goes ON.

- The data stored in flash memory will not be lost even if power remains off for a period exceeding the data backup period, because the data stored in flash memory will be read to the CPU Unit when the CPM1 is turned on.
- If the power is turned off without changing the mode from PROGRAM mode to RUN or MONITOR mode after having made changes in the data that is backed up in flash memory, the changes will not be written to flash memory. If the power is then left off for more than 20 days (at 25°C), the changes (i.e., the contents of the RAM) will be erased and the data values will become undefined.

# SECTION 1

## Introduction

This section describes the CPM1's special features and functions and shows the possible system configurations. Refer to the *Programming Manual* (W228) for details on programming actual operation.

- 1-1 CPM1 Features and Functions ..... 2
  - 1-1-1 CPM1 Features ..... 2
  - 1-1-2 I/O Terminal – IR Bit Allocation ..... 3
  - 1-1-3 CPM1 Functions ..... 4
- 1-2 System Configuration ..... 8
  - 1-2-1 CPU Unit and Expansion I/O Unit Configuration ..... 8
  - 1-2-2 Host Link Communications ..... 9
  - 1-2-3 1-to-1 Communications Links ..... 11
  - 1-2-4 NT Link Communications ..... 12
  - 1-2-5 Peripheral Device Connections ..... 12
- 1-3 Revised Specifications ..... 14

# 1-1 CPM1 Features and Functions

## 1-1-1 CPM1 Features

### One-piece Construction

The CPM1 is a one-piece PC with 10, 20, or 30 I/O terminals built into the CPU Unit.

CPM1-10CDR-□ (10 I/O Terminals)

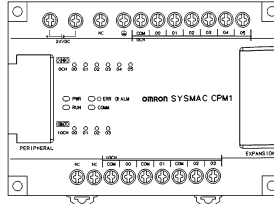

CPM1-20CDR-□ (20 I/O Terminals)

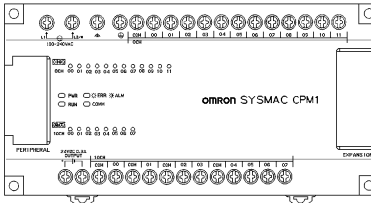

CPM1-30CDR-□ (30 I/O Terminals)

CPM1-30CDR-□-V1 (30 I/O Terminals) (Available soon)

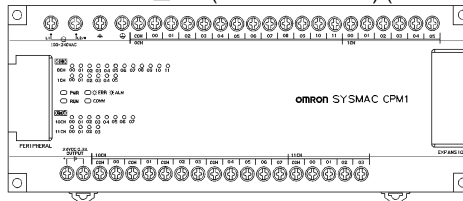

### Extra I/O Capacity

An Expansion I/O Unit can be connected to the CPU Unit to add an extra 20 I/O points.

By using the CPM1-30CDR-A-V1 (Available soon) or CPM1-30CDR-D-V1 (Available soon), I/O expansion up to 90 points is possible.

### Input Filter Function

The CPM1 is equipped with a filter function to prevent incorrect operation caused by chatter or noise in the input signal. The user can select an input time constant of 1 ms, 2 ms, 4 ms, 8 ms, 16 ms, 32 ms, 64 ms, or 128 ms.

### Low-maintenance Design

Flash memory provides memory backup without a battery.

### Conforms to EC Directives

The CPM1 PCs conform to EC directives (EMC and low-voltage directives), so they can be incorporated in equipment destined for the EC. Contact your OMRON representative for more details.

### Input Interrupts

The CPM1-10CDR-□ PCs can handle 2 interrupt inputs; the CPM1-20CDR-□ and CPM1-30CDR-□ (CPM1-30CDR-□-V1 (Available soon)) PCs can handle 4 interrupt inputs. In addition to normal input interrupts, the CPM1 has a counter mode that counts high-speed input signals and triggers interrupts at fixed count multiples.

### Quick-response Inputs

Quick-response inputs can detect input signals with a pulse width as short as 0.2 ms regardless of their timing during the PC cycle. Quick-response inputs and interrupt inputs use the same input terminals.

### Interval Timer

CPM1 PCs have a high-speed interval timer which can be set from 0.5 ms to 319968 ms. The timer can be set to trigger a single interrupt (one-shot mode) or repeat scheduled interrupts (scheduled interrupt mode).

- High-speed Counter** CPM1 PCs have a high-speed counter that can be used in incremental mode or up/down mode. The high-speed counter can be combined with input interrupts to perform target value control or zone comparison control that isn't affected by the PC's cycle time.
  
- Analog Setting Function** The CPM1 PCs have 2 analog volume controls that can be used to make manual analog settings.
  
- Host Link Communications** The CPM1 PCs are compatible with the Host Link, which allows communications with personal computers. The CPM1 using the Host Link can also communicate with Programmable Terminal using host link commands.  
  
An RS-232C Adapter is used for 1-to-1 communications and an RS-422 Adapter is used for 1-to-n communications.
  
- 1-to-1 Link** A data link can be created with a data area in another CPM1, CQM1, or C200HS PC. An RS-232C Adapter is used to make the 1-to-1 connection.
  
- NT Link Communications** High-speed operations can be achieved by providing a direct access by connecting the CPM1 to the Programmable Terminal through the NT Link Interface. An RS-232 Adapter is used for this connection.
  
- Standard Peripheral Devices** The CPM1 uses the same Programming Consoles, SYSMAC Support Software (SSS), and Ladder Support Software (LSS) as the Mini H-type and CQM1 PCs.
  
- Programming is Possible Using the PT** Programming operation is possible through the PT screen by using an OMRON PT that has a built-in Programming Console function.

### 1-1-2 I/O Terminal – IR Bit Allocation

The following table shows which IR bits are allocated to the I/O terminals on the CPM1's CPU Unit and Expansion I/O Unit.

**Note** The Expansion I/O Units consist of models with relay output. The Expansion I/O Units can also be connected to CPM1A Expansion I/O Units (sink type or source type) with transistor output. For more information about the transistor-output Expansion I/O Units of the CPM1A, refer to the *CPM1A Operation Manual (W317)*.

Number of I/O Terminals on the CPU Unit	CPU Unit Terminals		Expansion I/O Unit Terminals		Power Supply	Model Number
	Inputs	Outputs	Inputs	Outputs		
10	6 points: 00000 to 00005	4 points: 01000 to 01003	12 points: 00100 to 00111	8 points: 01100 to 01107	AC	CPM1-10CDR-A
					DC	CPM1-10CDR-D
20	12 points: 00000 to 00011	8 points: 01000 to 01007	12 points: 00100 to 00111	8 points: 01100 to 01107	AC	CPM1-20CDR-A
					DC	CPM1-20CDR-D
30	18 points: 00000 to 00011 00100 to 00105	12 points: 01000 to 01007 01100 to 01103	12 points: 00200 to 00211	8 points: 01200 to 01207	AC	CPM1-30CDR-A
					DC	CPM1-30CDR-D
		36 points: 00200 to 00211 00300 to 00311 00400 to 00411	24 points: 01200 to 01207 01300 to 01307 01400 to 01407	AC	CPM1-30CDR-A-V1 (Available soon)	
				DC	CPM1-30CDR-D-V1 (Available soon)	

### 1-1-3 CPM1 Functions

#### Analog Setting Function

CPM1 PCs have 2 analog volume controls that can be used to make analog timer and counter settings manually. When one of the volume controls is turned, the content of the corresponding IR word is set automatically between 0 and 200 (BCD).

Adjust the volume control with a Phillips-head screwdriver.

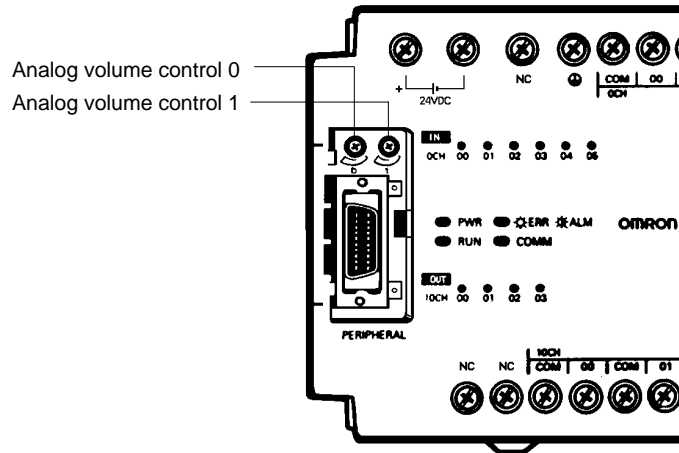

The following table shows which IR words are allocated to the analog controls on the CPM1's CPU Unit.

Control	Corresponding IR word	Setting range (BCD)
Analog volume control 0	IR 250	0000 to 0200
Analog volume control 1	IR 251	

#### Input Filter Function

The input time constant for the CPM1's external inputs can be set to 1, 2, 4, 8, 16, 32, 64, or 128 ms. Increasing the input time constant can reduce the effects of chatter or noise in the input signal.

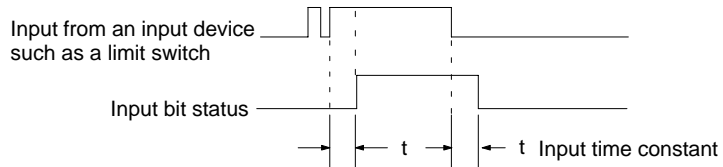

With the CPM1, actual response time for each set input time constant for word 000 is different from that for word 001 or later.

Set value	Word 000	Word 001 or later
1 ms	1 to 1.5 ms	0.1 to 0.3 ms
2 ms	2 to 2.5 ms	0.7 to 1.5 ms
4 ms	4 to 4.5 ms	1.5 to 2.5 ms
8 ms	8 to 8.5 ms	3 to 4.5 ms
16 ms	16 to 16.5 ms	6 to 9 ms
32 ms	32 to 32.5 ms	12 to 18 ms
64 ms	64 to 64.5 ms	24 to 35 ms
128 ms	128 to 128.5 ms	50 to 70 ms

The input response time of the CPM1 is obtained with the following:

$$2 \text{ ms max. (hardware performance)} + \text{input time constant (see above table)} + \text{cycle time}$$

**Input Interrupts**

The CPM1-10CDR-□ PCs have 2 interrupt input terminals and the CPM1-20CDR-□ and CPM1-30CDR-□ PCs have 4 interrupt input terminals. There are two modes for input interrupts: input interrupt mode and counter mode.

- 1, 2, 3...**
1. When an interrupt occurs in Input Interrupt Mode, the main program is interrupted and the interrupt program is executed immediately, regardless of the cycle time.
  2. In Counter Mode, external input signals are counted at high speed (up to 1 kHz) and an interrupt is generated each time the count reaches the set value. When an interrupt occurs, the main program is interrupted and the interrupt program is executed. The set value can be set from 0 to 65,535.

The following diagram shows the program execution when an interrupt occurs.

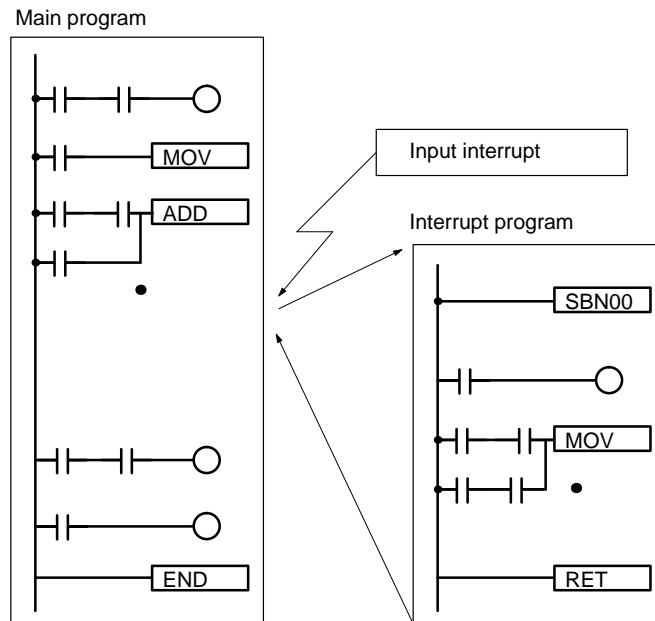

PC model	Input bits	Response time
CPM1-10CDR-□	IR 00003 to IR 00004	0.3 ms (1 kHz in Counter Mode)
CPM1-20CDR-□	IR 00003 to IR 00006	
CPM1-30CDR-□		
CPM1-30CDR-□-V1 (Available soon)		

**Note** When not using as interrupt input terminals, the input bits IR 00003 to IR 00006 can be used as normal input terminals.

Refer to the *CQM1/CPM1/CPM1A/SRM1 Programming Manual (W228)* for setting and using the input interrupts.



**Quick-response Inputs**

The CPM1-10CDR-□ PCs have 2 quick-response input terminals and the CPM1-20CDR-□/30CDR-□ PCs have 4 quick-response input terminals. (The same terminals are used for quick-response inputs and interrupt inputs.)

Quick-response inputs have an internal buffer, so input signals shorter than one cycle can be detected.

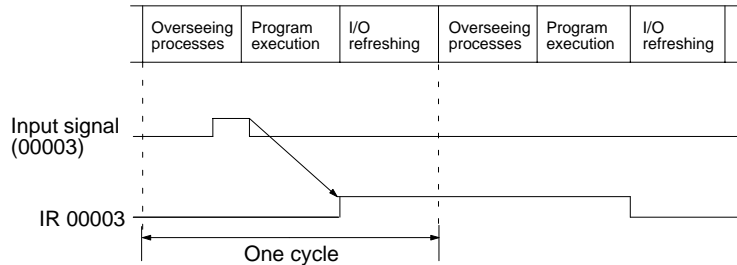

PC model	Input bits	Min. input pulse width
CPM1-10CDR-□	IR 00003 to IR 00004	0.2 ms
CPM1-20CDR-□	IR 00003 to IR 00006	
CPM1-30CDR-□		
CPM1-30CDR-□-V1 (Available soon)		

**Interval Timer Function (Scheduled Interrupts)**

CPM1 PCs are equipped with an interval timer which can be set from 0.5 ms to 319,968 ms in units of 0.1 ms. The timer can be set to trigger a single interrupt (one-shot mode) or repeat scheduled interrupts (scheduled interrupt mode).

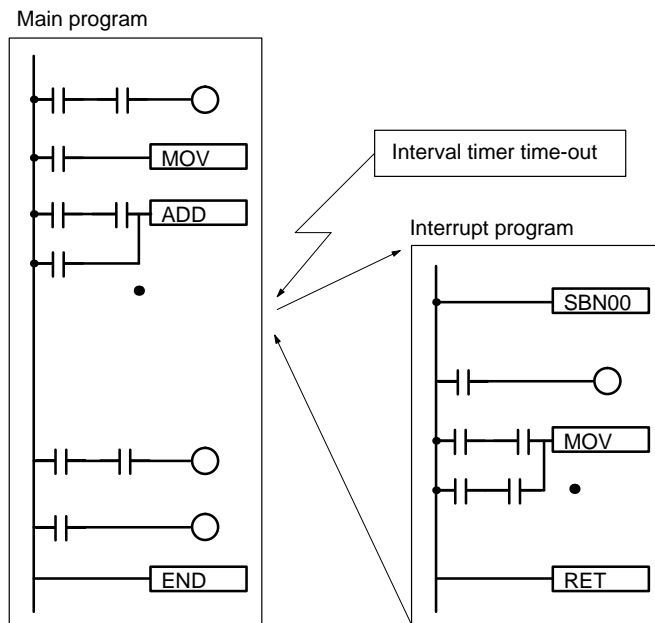

Mode	Function
One-shot	Generates a single interrupt the first time that the timer times out.
Scheduled interrupt	Generates an interrupt each time that the timer times out.

Refer to the CQM1/CPM1/CPM1A/SRM1 Programming Manual (W228) for setting and using the interval timer function.

**High-speed Counter**

CPM1 PCs have a high-speed counter that can be used in incremental mode or up/down mode. The high-speed counter can be combined with input interrupts to perform target value control or zone comparison control that isn't affected by the PC's cycle time.

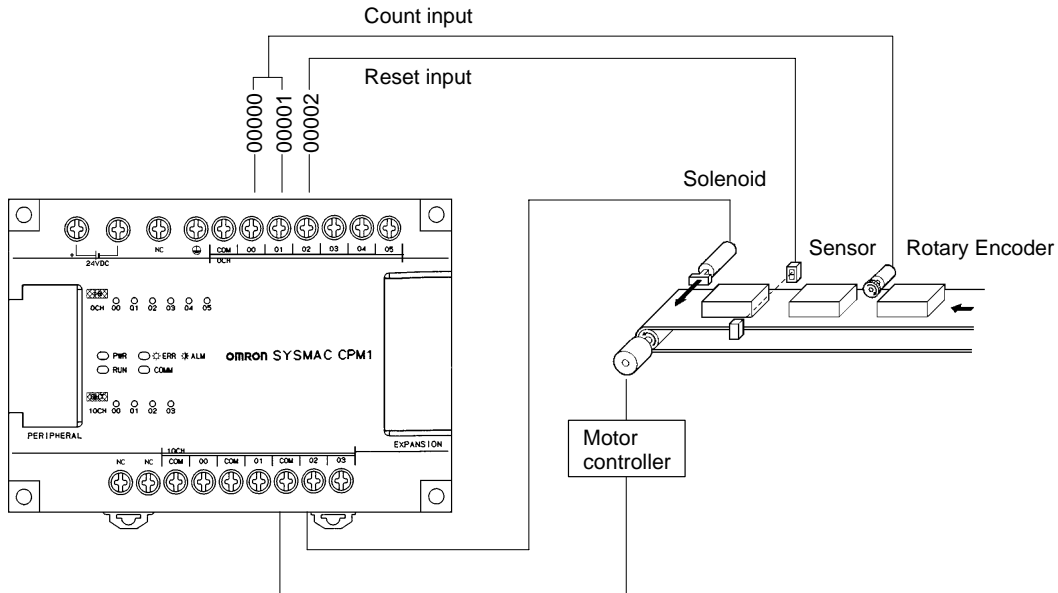

Mode	Input functions	Input method	Count frequency	Count range	Control methods
Up/Down	00000: A-phase input 00001: B-phase input 00002: Z-phase input	Phase-difference, 4× inputs	2.5 kHz	-32767 to 32767	Target value control: Up to 16 target values and interrupt subroutine numbers can be registered.
Incremental	00000: Count input 00001: See note. 00002: Reset input	Individual inputs	5.0 kHz	0 to 65535	Zone comparison control: Up to 8 sets of upper limit values, lower limit values, and interrupt subroutine numbers can be registered.

**Note** In incremental mode, this input (00001) can be used as a regular input.

Refer to the *CQM1/CPM1/CPM1A/SRM1 Programming Manual (W228)* for setting and using the high-speed counter.

# 1-2 System Configuration

## 1-2-1 CPU Unit and Expansion I/O Unit Configuration

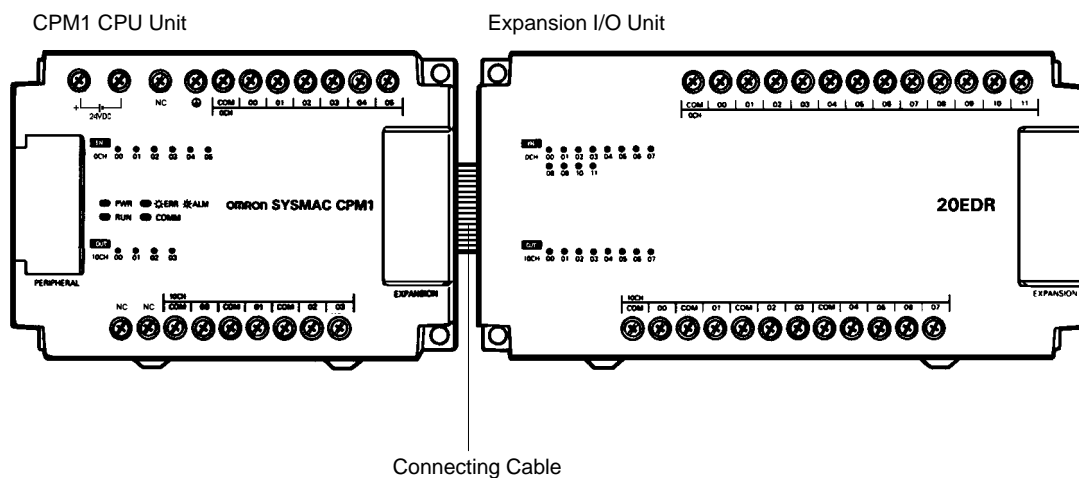

### CPM1 CPU Units

The following table describes the six CPM1 CPU Units. All outputs are relay outputs.

Number of I/O terminals	Inputs	Outputs	Power supply	Model number
10	6 points	4 points	AC	CPM1-10CDR-A
			DC	CPM1-10CDR-D
20	12 points	8 points	AC	CPM1-20CDR-A
			DC	CPM1-20CDR-D
30	18 points	12 points	AC	CPM1-30CDR-A
			DC	CPM1-30CDR-D
			AC	CPM1-30CDR-A-V1 (Available soon)
			DC	CPM1-30CDR-D-V1 (Available soon)

### CPM1 Expansion I/O Unit

The following table describes the CPM1 Expansion I/O Unit. All outputs are relay outputs.

Number of I/O terminals	Inputs	Outputs	Model number
20	12 points	8 points	CPM1-20EDR

- CPM1A Expansion I/O Units with transistor output can also be connected to a CPM1 CPU Unit.
- For the CPM1-30CDR-□-V1 (Available soon), a maximum of three Expansion I/O Units can be connected. For other CPU Units, only one Expansion I/O Unit can be connected.

**Note** Do not touch the Expansion I/O Unit Connecting Cable while the power is being supplied in order to prevent any malfunction due to static electricity.

### 1-2-2 Host Link Communications

Host Link communications which allows up to 32 OMRON PCs to be controlled from a host computer. The computer-PC connections can be made connectors such as RS-232C and RS-422 Adapters.

#### 1-to-1 Communications

The following diagram shows the possible methods for a 1-to-1 connection between a CPM1 and an IBM PC/AT or compatible computer.

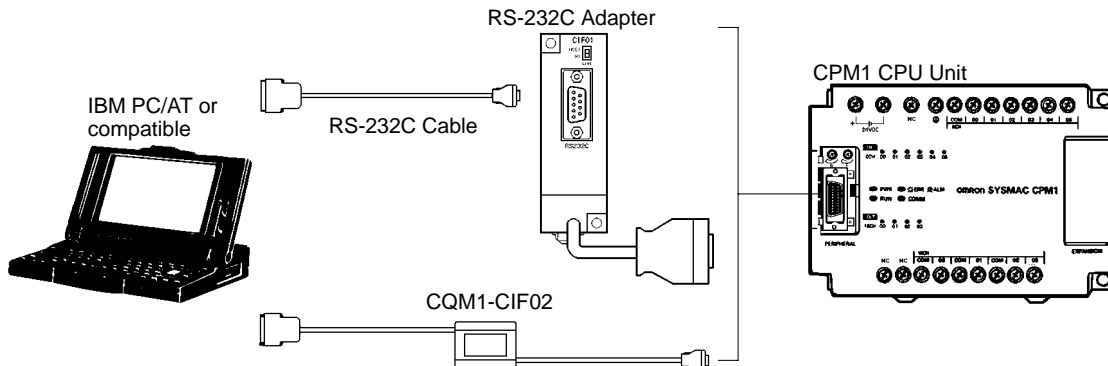

#### Connecting to a Programmable Terminal

The following diagram shows the possible methods for a connection between a CPM1 PC and an OMRON Programmable Terminal (a display device).

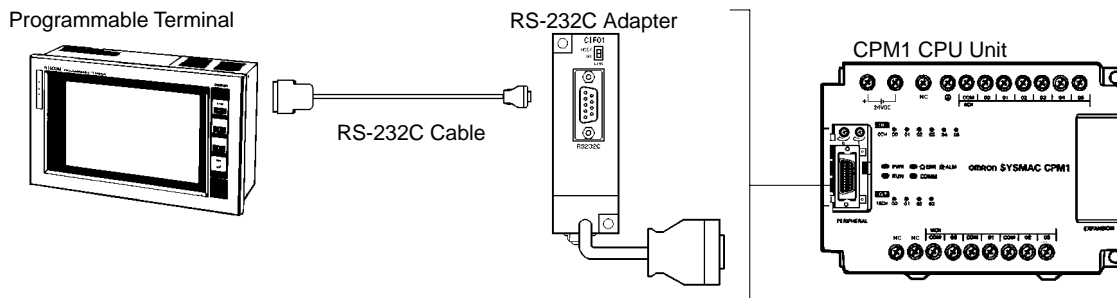

1-to-n Communications

The following diagram shows how to connect up to 32 CPM1 PCs to an IBM PC/AT or compatible computer.

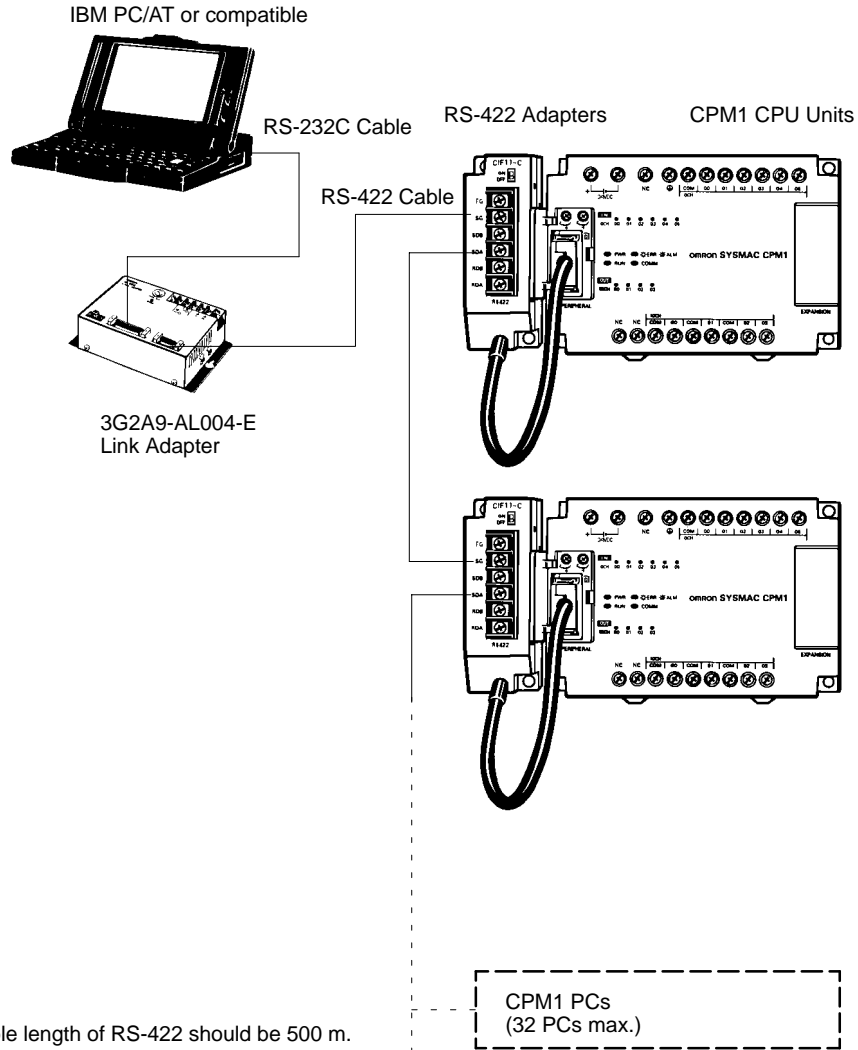

The maximum cable length of RS-422 should be 500 m.

Adapters and Cables

The following table lists some of the Adapters and Cables used in Host Link communications.

Name	Usage	Model Number
RS-232C Adapter	Converts to peripheral port-level communications.	CPM1-CIF01
RS-422 Adapter		CPM1-CIF11
Connecting Cables	Used to connect IBM PC/AT or compatible computers. (Cable length: 3.3 m)	CQM1-CIF02
Link Adapter	Converts between the RS-232C and RS-422 formats.	3G2A9-AL004-E

### 1-2-3 1-to-1 Communications Links

A data link can be created with a data area in another CPM1, CQM1, or C200HS PC. An RS-232C Adapter must be used to make the 1-to-1 connection.

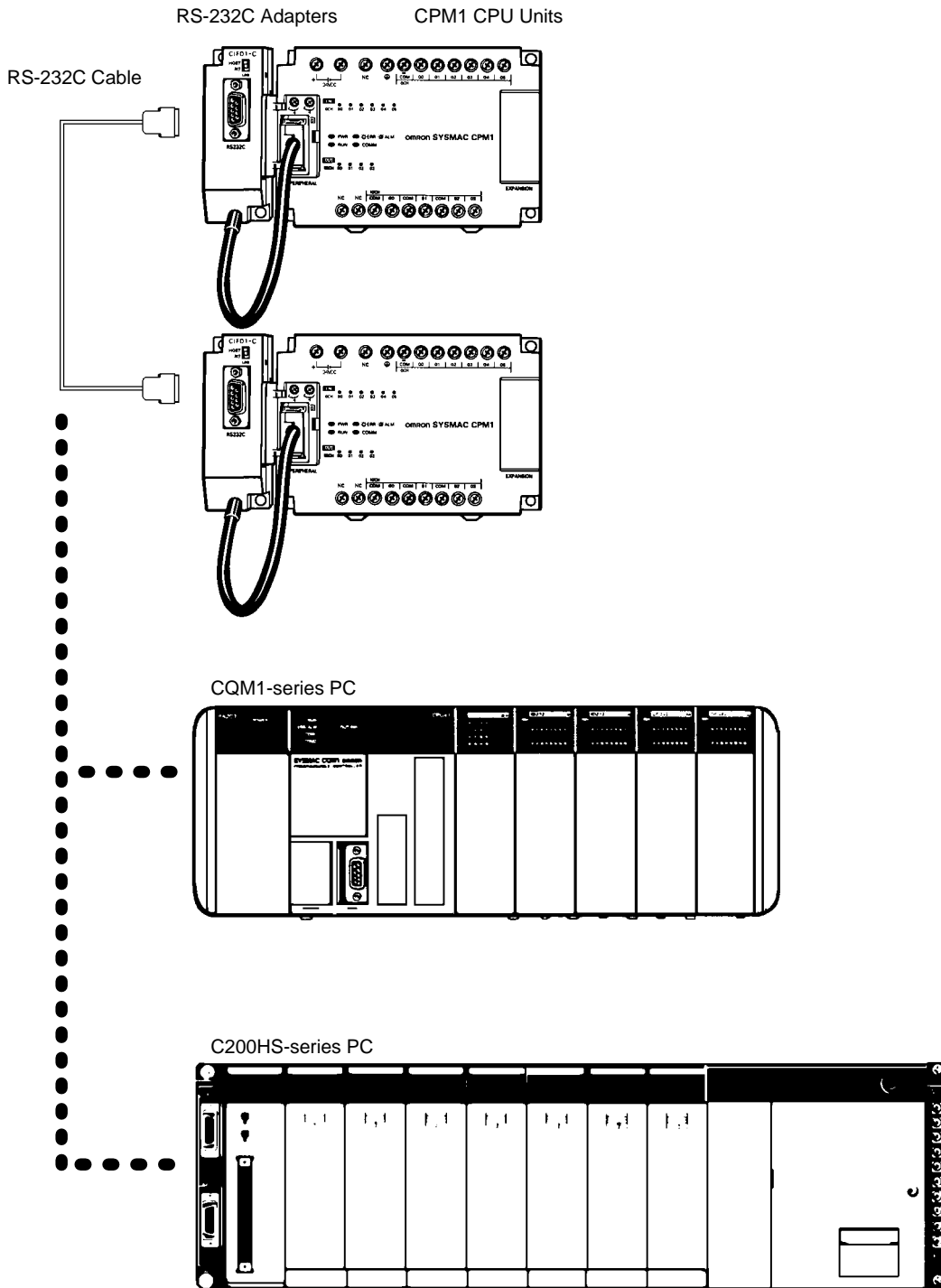

Name	Usage	Model Number
RS-232C Adapter	Converts to the Peripheral Port format.	CPM1-CIF01

### 1-2-4 NT Link Communications

Using the NT Link, the CPM1 PC can be connected to the Programmable Terminal (NT Link Interface) through an RS-232C Adapter.

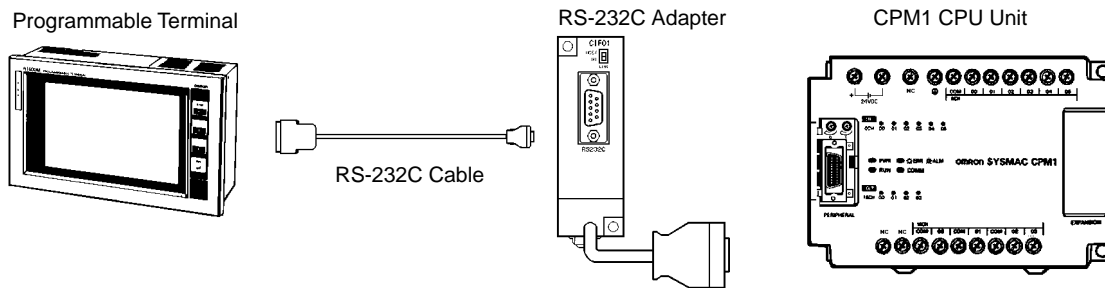

Name	Usage	Model Number
RS-232C Adapter	Converts to the Peripheral Port format.	CPM1-CIF01

### 1-2-5 Peripheral Device Connections

CPM1 programming can be created or edited with a Programming Console or a personal computer running the SYSMAC Support Software (SSS).

#### Programming Console

A CQM1-PRO01-E or C200H-PRO27-E Programming Console can be connected to the CPM1 as shown in the following diagram.

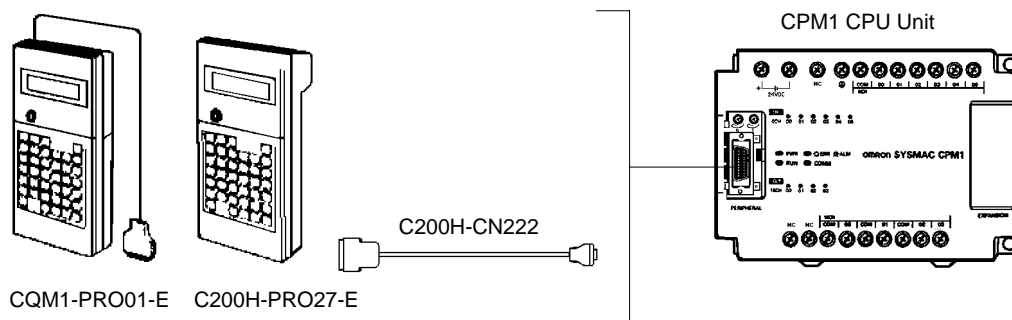

Name		Model Number
CQM1-series Programming Console (The Connecting Cable is attached.)		CQM1-PRO01-E
C200H-series Programming Console		C200H-PRO27-E
C200H-series Connecting Cables	Cable length: 2 m	C200H-CN222
	Cable length: 4 m	C200H-CN422

**SYSMAC Support Software and SYSMAC-CPT Support Software**

An IBM PC/AT or compatible personal computer running SSS or the SYSMAC-CPT Support Software can be connected to the CPM1A as shown in the following diagram. Refer to 3-4-7 *Host Link Connections* for a diagram showing the standard wiring for the RS-232C cable.

Any version of the Support Software may be used. Refer to 4-1 *Support Software Capabilities* for further details on installing and using Support Software.

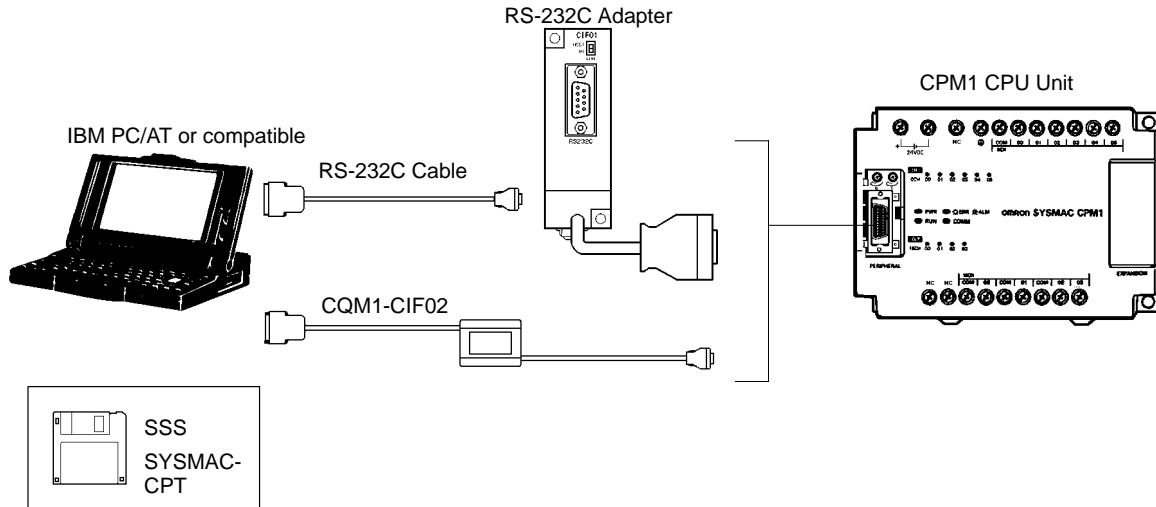

Name	Usage	Model Number
RS-232C Adapter	Converts to Peripheral Port format level communications.	CPM1-CIF01
Connecting Cable	Used to connect IBM PC/AT or compatible computers. (Length: 3.3 m)	CQM1-CIF02 (see note)
SYSMAC Support Software	For IBM PC/AT or compatible computers (3.5" disks, 2HD)	C500-ZL3AT1-E
SYSMAC-CPT Support Software	For IBM PC/AT or compatible computers (3.5" disks (2HD) and CDROM)	WS01-CPTB1-E

**Note** Specify the model number when making a new purchase of a product.



## 1-3 Revised Specifications

The following table shows the changes that have been made in product specifications beginning with lots produced in January 1998 (December 1997 for some models).

Item	Previous specifications	New specifications	Relevant pages
Input indicator operation when an error occurs	The input indicators will maintain the current status and will not change with the status of the input signal when a memory error, no END instruction error, or system error occurs.	The input indicators will change with the status of the input signal when a memory error, no END instruction error, or system error occurs.	Item 8., <i>Input Indicators</i> , on page 24.
Memory holding operation of built-in capacitor	If the power remains OFF for a period exceeding the data backup period, the capacitor will not be able to back up data and the status of the data backed up by the capacitor (Read/write DM area, Error log area, HR area, and Counter area) will become unstable.	If the power remains OFF for a period exceeding the data backup period, AR 1314 will turn ON to indicate that the capacitor can no longer back up data and the data backed up by the capacitor (Read/write DM area, Error log area, HR area, and Counter area) will be cleared. The PC Setup setting in DM 6604 can be set to create a fatal error and thus stop the system when AR 1314 goes ON.	Page xiii and xv under 5 <i>Application Precautions</i> . Page 18 under 2-1-2 <i>Characteristics</i> . See also information on the PC Setup in the <i>CQM1/CPM1/CPM1A/SRM1 Programmable Controllers Programming Manual (W228)</i> .
Online editing and changing set values from the SSS	If unsupported addresses are set in the program for operands or for set values for timers or counters from the SSS during online editing, the values will be accepted, but a memory error will occur in MONITOR or RUN mode.	If unsupported addresses are set in the program for operands or for set values for timers or counters from the SSS during online editing, error messages will be displayed and the values will not be accepted.	4-1-2 <i>CPM1 Restrictions and Precautions</i>
Communications parameters for the peripheral port	Communications are not possible if unsupported settings are made for the peripheral port's communications parameters.	Communications are possible using the following parameters if unsupported settings are made for the peripheral port's communications parameters.  Mode: Host Link Standard format 1 start bit 7-bit data Even parity 2 stop bits 9,600 bps baud Transmission delay: None Unit number: 0	See information on the PC Setup in the <i>CQM1/CPM1/CPM1A/SRM1 Programmable Controllers Programming Manual</i> .

## SECTION 2

# Unit Specifications and Components

This section provides the technical specifications of the Units that go together to create a CPM1 PC and describes the main components of the Units.

2-1	Specifications .....	16
2-1-1	General Specifications .....	16
2-1-2	Characteristics .....	17
2-1-3	I/O Specifications .....	19
2-1-4	Communications Adapter Specifications .....	21
2-2	Unit Components .....	22
2-2-1	CPU Unit Components .....	22
2-2-2	Expansion I/O Unit Components .....	25
2-2-3	Communications Adapter Components .....	26

## 2-1 Specifications

### 2-1-1 General Specifications

Item		CPM1-10CDR-□	CPM1-20CDR-□	CPM1-30CDR-□ CPM1-30CDR-□-V1 (see note 2)
Supply voltage	AC type	100 to 240 VAC, 50/60 Hz		
	DC type	24 VDC		
Operating voltage range	AC type	85 to 264 VAC		
	DC type	20.4 to 26.4 VDC		
Power consumption	AC type	60 VA max.		
	DC type	20 W max.		
Inrush current		60 A max.		
External power supply (AC type only)	Supply voltage	24 VDC		
	Output capacity	300 mA (see note)		
Insulation resistance		20 MΩ min. (at 500 VDC) between the external AC terminals and protective earth terminals		
Dielectric strength		2,300 VAC 50/60 Hz for 1 min between the external AC and protective earth terminals, leakage current: 10 mA max.		
Noise immunity		1,500 Vp-p, pulse width: 0.1 to 1 μs, rise time: 1 ns (via noise simulation)		
Vibration resistance		10 to 57 Hz, 0.075-mm amplitude, 57 to 150 Hz, acceleration: 9.8 m/s <sup>2</sup> (1G) in X, Y, and Z directions for 80 minutes each (Time coefficient; 8 minutes × coefficient factor 10 = total time 80 minutes)		
Shock resistance		147 m/s <sup>2</sup> (15G) three times each in X, Y, and Z directions		
Ambient temperature		Operating: 0° to 55°C Storage: -20° to 75°C		
Humidity		10% to 90% (with no condensation)		
Atmosphere		Must be free from corrosive gas		
Terminal screw size		M3		
Grounding		Less than 100 □		
Power interrupt time		AC type: 10 ms min. DC type: 2 ms min.  (A power interruption occurs if power falls below 85% of the rated voltage for longer than the power interrupt time.)		
CPU Unit weight	AC type	600 g max.	800 g max.	900 g max.
	DC type	500 g max.	700 g max.	800 g max.
Expansion I/O Unit weight		600 g max.		

- Note**
1. When the external power supply provides an excessive current or is short circuited, the external power supply voltage drops. The PC will, however, continue to operate.
  2. CPM1-30CDR-□-V1 will be available soon.

## 2-1-2 Characteristics

Item	CPM1-10CDR-□	CPM1-20CDR-□	CPM1-30CDR-□ CPM1-30CDR-□-V1 (see note 2)
Control method	Stored program method		
I/O control method	Cyclic scan with direct output; immediate refresh processing		
Programming language	Ladder diagram		
Instruction length	1 step per instruction, 1 to 5 words per instruction		
Types of instructions	Basic instructions: 14 Special instructions: 77 types, 134 instructions		
Execution time	Basic instructions: 0.72 to 16.2 μs Special instructions: 16.3 μs (MOV instruction)		
Program capacity	2,048 words		
Input bits	00000 to 00915 (Words not used for input bits can be used for work bits.)		
Output bits	01000 to 01915 (Words not used for output bits can be used for work bits.)		
Work bits	512 bits: 20000 to 23115 (Words IR 200 to IR 231)		
Special bits (SR area)	384 bits: 23200 to 25515 (Words IR 232 to IR 255)		
Temporary bits (TR area)	8 bits (TR0 to TR7)		
Holding bits (HR area)	320 bits: HR 0000 to HR 1915 (Words HR 00 to HR 19)		
Auxiliary bits (AR area)	256 bits: AR 0000 to AR 1515 (Words AR 00 to AR 15)		
Link bits (LR area)	256 bits: LR 0000 to LR 1515 (Words LR 00 to LR 15)		
Timers/Counters	128 timers/counters (TIM/CNT 000 to TIM/CNT 127)  100-ms timers: TIM 000 to TIM 127 10-ms timers (high-speed counter): TIM 000 to TIM 127 (see note 1) (the timer numbers used are the same as for the 100-ms timers) Decrementing counters and reversible counters		
Data memory	Read/Write: 1,024 words (DM 0000 to DM 1023) Read-only: 512 words (DM 6144 to DM 6655)		
Interrupt processing	External interrupts: 2 (Response time: 0.3 ms max.)	External interrupts: 4 (Response time: 0.3 ms max.)	
Input interrupts	2	4	
Interval timer interrupts	1 (0.5 to 319,968 ms in Scheduled Interrupt Mode or Single Interrupt Mode)		
Memory protection	HR and read/write DM area contents; and counter values maintained during power interruptions.		
Memory backup	Flash memory: The program, read-only DM area, and PC Setup area are backed up without a battery.  Capacitor backup: The read/write DM area, error log area, HR area, and counter values are backed up by a capacitor for 20 days at 25°C. The capacitor backup time depends on the ambient temperature. See the graph on the following page for details.		
Self-diagnostic functions	CPU Unit failure (watchdog timer), I/O bus error, and memory failure		
Program checks	No END instruction, programming errors (continuously checked during operation)		
High-speed counter	One high-speed counter: 5 kHz single-phase or 2.5 kHz two-phase (linear count method) Increment mode: 0 to 65,535 (16 bits) Up/Down mode: -32,767 to 32,767 (16 bits)		
Quick-response inputs	The same inputs are used for quick-response inputs and external interrupt inputs. (Min. input puls width: 0.2 ms)		
Input time constant	Can be set to 1 ms, 2 ms, 4 ms, 8 ms, 16 ms, 32 ms, 64 ms, or 128 ms.		
Analog volume settings	2 controls (0 to 200 BCD)		

- Note**
1. Use TIM 000 to TIM 003 when creating a timer using the high-speed timer instruction to perform interrupt processing.
  2. CPM1-30CDR-□-V1 will be available soon.

**Memory Backup**

The user program and memory area data in the CPM1 are backed up either by an internal capacitor or in flash memory as shown in the following table.

Backup method	Data
Internal capacitor	Read/write DM area (DM 0000 to DM 0999, DM 1022, and DM 1023) Error log area (DM 1000 to DM 1021) HR area (HR 00 to HR 19) Counter area (CNT 000 to CNT 127)
Flash memory	User program Read-only DM area (DM 6144 to DM 6599) PC Setup (DM 6600 to DM 6655)

- Note**
1. The IR, TR, LR, and timer areas are not normally backed up when power is turned off and all contents will be cleared the next time power is turned on. (The PC Setup setting in DM 6601 can be used to back up this data. Refer to details on the PC Setup later in this manual for details.)
  2. The bits in the AR and SR areas have special functions and are set according to these functions when power is turned on.

The capacitor backup time depends on the ambient temperature, as shown in the following graph. The backup time, however, assumes that the capacitor is fully charged, which requires that power be supplied to the CPU Unit continuously for at least 15 minutes.

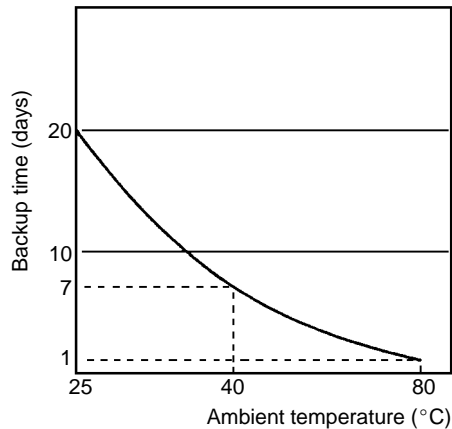

If the power remains off for a period exceeding the data backup period, AR 1314 will turn ON to indicate that the capacitor can no longer back up data and the data backed up by the capacitor will be cleared. AR 1314 will remain ON unless it is turned OFF using I/O monitor operations, using memory clear operations, or from the user program.

If desired, the PC Setup setting in DM 6604 can be set to create a fatal error and thus stop the system when AR 1314 goes ON.

The data stored in flash memory will not be lost even if power remains off for a period exceeding the data backup period, because the data stored in flash memory will be read to the CPU Unit when the CPM1 is turned on.

If the power is turned off without changing the mode from PROGRAM mode to RUN or MONITOR mode after having made changes in the data that is backed up in flash memory, the changes will not be written to flash memory. If the power is then left off for more than 20 days (at 25°C), the changes (i.e., the contents of the RAM) will be erased and the data values will become undefined.

Either switch the CPM1 to RUN or MONITOR mode, or turn off and on power to the CPM1 after changing from a Programming Device any data that is backed up in flash memory. This data includes the user program, read-only DM area (DM 6144 to DM 6599), and the PC Setup (DM 6600 to DM 6655).

### 2-1-3 I/O Specifications

#### CPU Unit Input Specifications

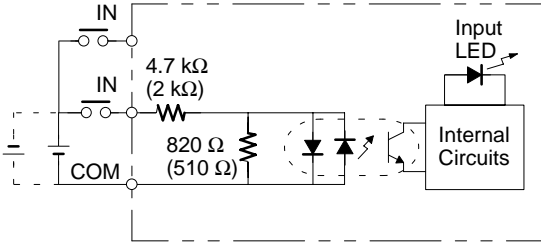
Item	Specification
Input voltage	24 VDC $+10\%/_{-15\%}$
Input impedance	IN00000 to IN00002: 2 k $\Omega$ ; other inputs: 4.7 k $\Omega$
Input current	IN00000 to IN00002: 12 mA typical; other inputs: 5 mA typical
ON voltage	14.4 VDC min.
OFF voltage	5.0 VDC max.
ON delay	1 to 128 ms max. (default: 8 ms) (see note.)
OFF delay	1 to 128 ms max. (default: 8 ms) (see note.)
Circuit configuration	 <p><b>Note</b> Figures in parentheses are for IN00000 to IN00002.</p>

**Note** Using the PC Setup, 1, 2, 4, 8, 16, 32, 64, or 128 ms can be selected. When IN00000 through IN00002 are used as high-speed counter inputs, the delays are as shown in the following table.

Input	Increment mode	Differential phase mode
IN00000 (A-phase)	5 KHz	2.5 KHz
IN00001 (B-phase)	Normal input	
IN00002 (Z-phase)	ON: 100 $\mu$ s min.; OFF delay: 500 $\mu$ s min.	

The minimum delay is as follows.

#### Increment Mode (5 KHz Max.)

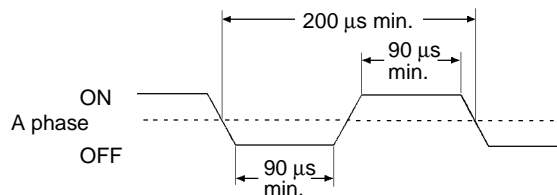

**Differential Phase Mode (2.5 KHz Max.)**

IN00000 (A phase), IN00001 (B phase)

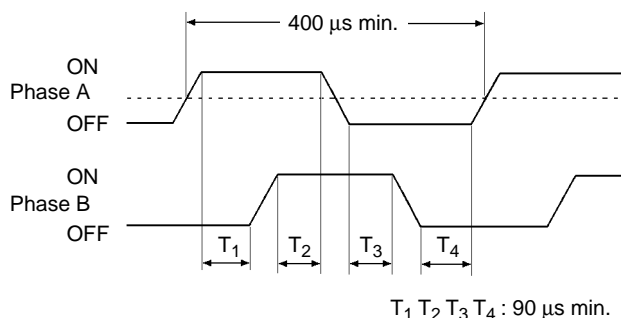

IN00002 (Z phase)

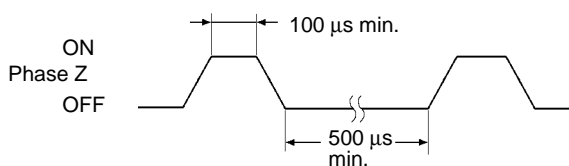

When IN00003 through IN00006 are used as interrupt inputs, the delay is 0.3 ms max. The delay is measured from the time that the input goes ON until the interrupt subroutine is executed.

**Expansion I/O Unit Input Specifications**

Item	Specification
Input voltage	24 VDC +10%/-15%
Input impedance	4.7 kΩ
Input current	5 mA typical
ON voltage	14.4 VDC min.
OFF voltage	5.0 VDC max.
ON delay	1 to 128 ms max. (default: 8 ms) (see note.)
OFF delay	1 to 128 ms max. (default: 8 ms) (see note.)
Circuit configuration	

**Note** Using the PC Setup, 1, 2, 4, 8, 16, 32, 64, or 128 ms can be selected.

**Caution** Do not apply voltage in excess of the rated voltage to the input terminal. It may result in damage to the product or fire.

### CPU Unit and Expansion I/O Unit Output Specifications

Item	Specification
Output type	All outputs are relay outputs.
Max. switching capacity	2 A, 250 VAC ( $\cos\phi = 1$ ) 2 A, 24 VDC (4 A/common)
Min. switching capacity	10 mA, 5 VDC
Service life of relay	Electrical: 300,000 operations (resistive load) 100,000 operations (inductive load) Mechanical: 10,000,000 operations
ON delay	15 ms max.
OFF delay	15 ms max.
Circuit configuration	<p>Maximum 250 VAC: 2 A 24 VDC: 2 A</p>

**Caution** Do not connect loads or apply voltage in excess of the maximum switching capacity to an output terminal. It may result in damage to the product or fire.

## 2-1-4 Communications Adapter Specifications

### RS-232C Adapter Specifications

Item	Specification
Function	Converts between the CMOS format (PC CPU Unit side) and the RS-232C format (peripheral device side).
Insulation	The RS-232C (peripheral device side) is isolated by a DC/DC convertor and photocoupler.
Power supply	Power is supplied from the PC CPU Unit.
Power consumption	0.3 A max.
Baud rate	38,400 bps max.
Transmission distance	Total length: 15 m max.
Vibration resistance	10 to 57 Hz: 0.075-mm amplitude 57 to 150 Hz: 9.8 m/s <sup>2</sup> (1G) acceleration in X, Y, and Z directions for 80 minutes each (Time coefficient; 8 minutes × coefficient factor 10 = total time 80 minutes)
Shock resistance	147 m/s <sup>2</sup> (15 G) three times each in X, Y, and Z directions
Ambient temperature	Operating: 0° to 55°C Storage: -20° to 75°C
Humidity	10% to 90% (with no condensation)
Atmosphere	Must be free from corrosive gas
Weight	200 g max.



### RS-422 Adapter Specifications

Item	Specification
Function	Converts between the CMOS format (PC CPU Unit side) and the RS-422 format (peripheral device side).
Insulation	The RS-422 (peripheral device side) is isolated by a DC/DC convertor and photocoupler.
Power supply	Power is supplied from the PC CPU Unit.
Power consumption	0.3 A max.
Baud rate	38,400 bps max.
Transmission distance	Total length: 500 m max.
Vibration resistance	10 to 57 Hz: 0.075-mm amplitude 57 to 150 Hz: 9.8 m/s <sup>2</sup> (1G) acceleration in X, Y, and Z directions for 80 minutes each (Time coefficient; 8 minutes × coefficient factor 10 = total time 80 minutes)
Shock resistance	147 m/s <sup>2</sup> (15G) three times each in X, Y, and Z directions
Ambient temperature	Operating: 0° to 55°C Storage: -20° to 75°C
Humidity	10% to 90% (with no condensation)
Atmosphere	Must be free from corrosive gas
Weight	200 g max.

## 2-2 Unit Components

### 2-2-1 CPU Unit Components

#### CPM1-10CDR-□

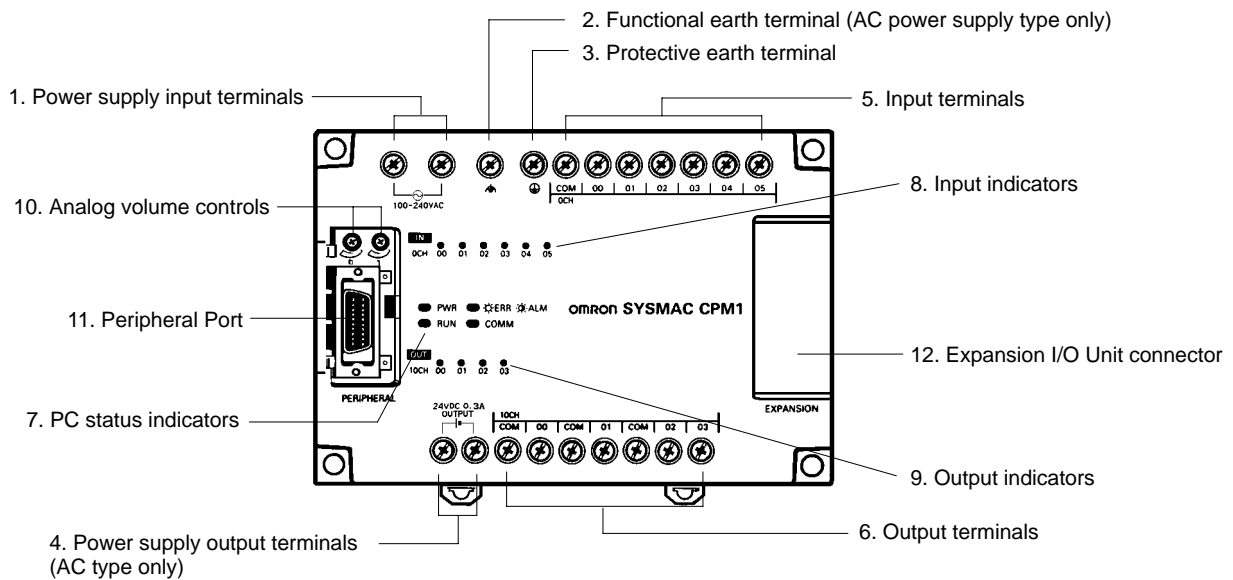

**CPM1-20CDR-□**

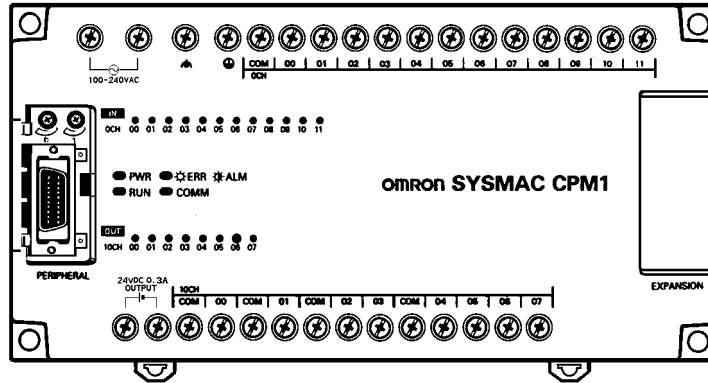

**CPM1-30CDR-□**  
**CPM1-30CDR-□-V1 (see note)**

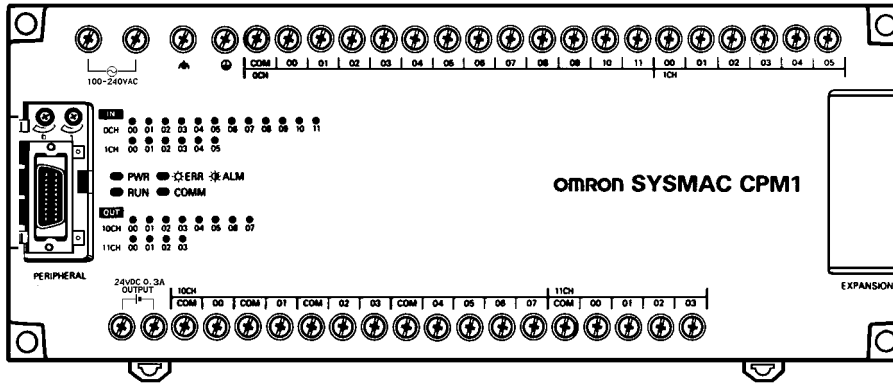

**Note** CPM1-30CDR-□-V1 will be available soon

**CPU Unit Component Descriptions**

- 1, 2, 3...**
1. Power Supply Input Terminals  
 Connect the power supply (100 to 240 VAC or 24 VDC) to these terminals.
  2. Functional Earth Terminal (⏏)  
 Be sure to ground this terminal (AC-type PCs only) to enhance immunity to noise and reduce the risk of electric shock.
  3. Protective Earth Terminal (⏏)  
 Be sure to ground this terminal to reduce the risk of electric shock.
  4. Power Supply Output Terminals  
 CPM1 PCs are equipped with these 24-VDC power output terminals to supply power to input devices (AC-type PCs only).
  5. Input Terminals  
 Connect to the input circuits.
  6. Output Terminals  
 Connect to the output circuits.

## 7. PC Status Indicators

These indicators show the operating status of the PC, as shown in the following table.

Indicator	Status	Meaning
POWER (green)	ON	Power is being supplied to the PC.
	OFF	Power isn't being supplied to the PC.
RUN (green)	ON	The PC is operating in RUN or MONITOR mode.
	OFF	The PC is in PROGRAM mode or a fatal error has occurred.
ERROR/ALARM (red)	ON	A fatal error has occurred. (PC operation stops.)
	Flashing	A non-fatal error has occurred. (PC operation continues.)
	OFF	Indicates normal operation.
COMM (orange)	ON	Data is being transferred via the Peripheral Port.
	OFF	Data isn't being transferred via the Peripheral Port.

## 8. Input Indicators

These indicators are lit when the corresponding input terminal is ON.

When a fatal error occurs, the input indicators change as follows:

Fatal error	Input indicators
CPU Unit error or I/O bus error	Turn OFF.
Memory error, no END instruction error, or system error	The indicators will change with the status of the input signal, but input status will not be updated in memory.

## 9. Output Indicators

These indicators are lit when the corresponding output terminal is ON.

## 10. Analog Volume Controls

Setting these controls sets the contents of IR 250 and IR 251 from 0 to 200.

## 11. Peripheral Port

Connects the PC to a Peripheral Device, RS-232C Adapter, or RS-422 Adapter.

## 12. Expansion I/O Unit Connector

Connects the PC's CPU Unit to an Expansion I/O Unit to add another 12 input points and 8 output points.

### 2-2-2 Expansion I/O Unit Components

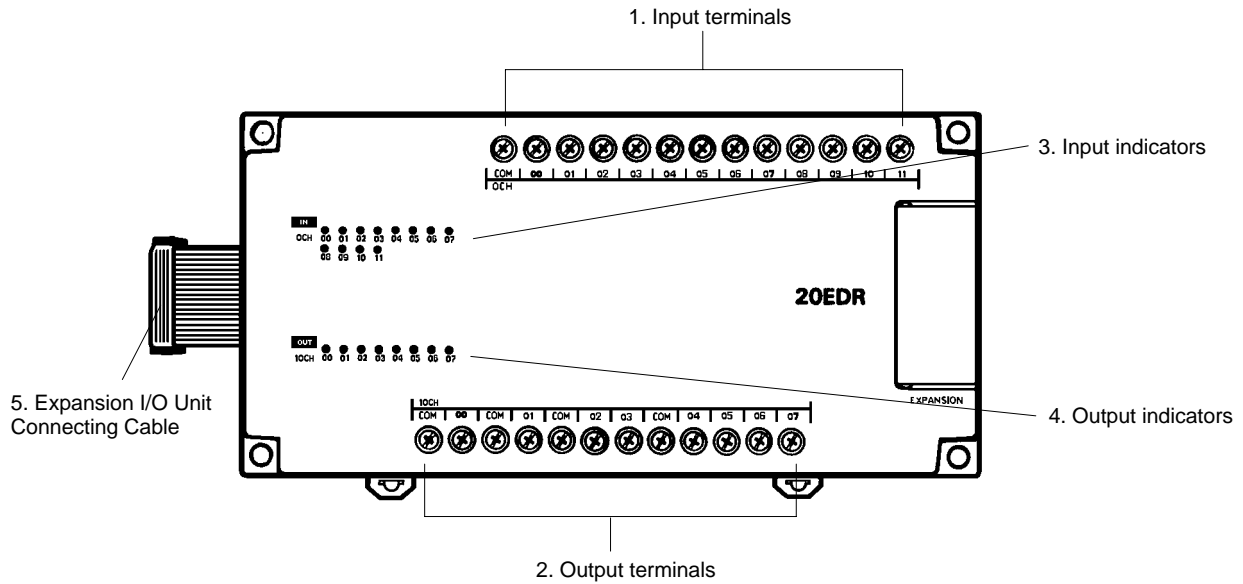

- 1, 2, 3...**
1. Input Terminals  
Connect to the input circuits.
  2. Output Terminals  
Connect to the output circuits.
  3. Input Indicators  
These indicators are lit when the corresponding input terminal is ON.
  4. Output Indicators  
These indicators are lit when the corresponding output terminal is ON.
  5. Expansion I/O Unit Connecting Cable  
Connects the Expansion I/O Unit to the PC's CPU Unit.

**! Caution** Do not touch the Expansion I/O Unit Connecting Cable while the power is being supplied in order to prevent any malfunction due to static electricity.

## 2-2-3 Communications Adapter Components

### RS-232C Adapter

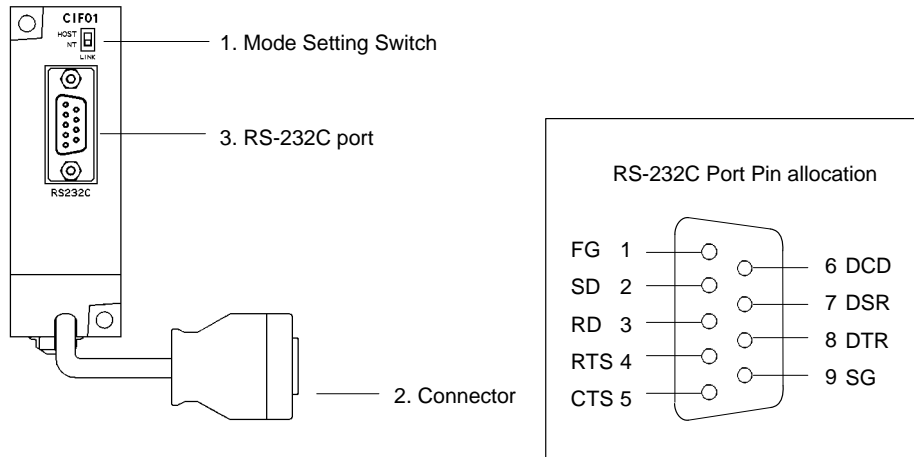

- 1, 2, 3...**
1. Mode Setting Switch  
Set this switch to “HOST” when using a Host Link system to connect to a personal computer. Set this switch to “NT” when connecting to a Programmable Terminal or PC for 1:1 link.
  2. Connector  
Connects to the CPU Unit’s Peripheral Port.
  3. RS-232C Port  
Connects to the RS-232C cable from the other device such as a personal computer, Peripheral Device, or Programmable Terminal.

### RS-422 Adapter

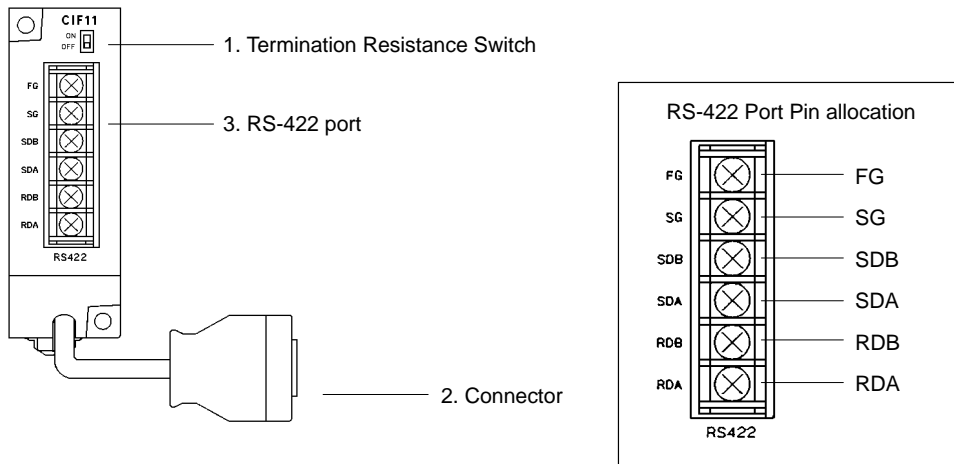

- 1, 2, 3...**
1. Termination Resistance Switch  
Set the termination resistance switch to “ON” (upper side) for the Link Adapters on both ends of the Host Link system and for the RS-422 Adapter.
  2. Connector  
Connects to the CPU Unit’s Peripheral Port.
  3. RS-422 Port  
Connects to the Host Link network.

**Note** The CPM1-CIF01/CIF11 are used with the CPM1A, CPM1, and SRM1 only. Do not use them with a C200HS PC or other PC.

# SECTION 3

## Installation and Wiring

This section provides information on installing and wiring a CPM1 PC. Be sure to follow the directions and precautions in this section when installing the CPM1 in a panel or cabinet, wiring the power supply, or wiring I/O.

3-1	Design Precautions . . . . .	28
3-1-1	Power Supply Wiring . . . . .	28
3-1-2	Interlock and Limit Circuits . . . . .	28
3-1-3	Power Supply Voltage . . . . .	28
3-1-4	CPM1 Power Interruptions . . . . .	28
3-2	Selecting an Installation Site . . . . .	29
3-2-1	Installation Site Conditions . . . . .	29
3-2-2	Panel/Cabinet Installation . . . . .	30
3-3	Installing the CPM1 . . . . .	30
3-3-1	CPM1 Orientation . . . . .	30
3-3-2	CPM1 Installation . . . . .	31
3-3-3	Connecting an Expansion I/O Unit . . . . .	33
3-4	Wiring and Connections . . . . .	34
3-4-1	General Precautions for Wiring . . . . .	34
3-4-2	Power Supply Wiring . . . . .	35
3-4-3	Input Wiring . . . . .	36
3-4-4	Output Wiring . . . . .	38
3-4-5	Conformance to EMC Directives . . . . .	40
3-4-6	Peripheral Device Connection . . . . .	42
3-4-7	Host Link Connections . . . . .	42
3-4-8	One-to-one PC Connections . . . . .	45
3-4-9	NT Link Connections . . . . .	46

## 3-1 Design Precautions

Observe the following precautions when designing a system incorporating a CPM1 PC.

### 3-1-1 Power Supply Wiring

Separate the power supply wiring from the control system, CPM1 system, and DC I/O system wiring.

### 3-1-2 Interlock and Limit Circuits

Construct an external interlock circuit if CPM1 outputs are used to perform reciprocal operations such as controlling the forward and reverse operation of a motor or if incorrect PC operation could cause accidents or mechanical damage. Also, construct an external limit circuit to prevent run-away movement in systems such as position control.

The following diagram shows an example of an interlock circuit.

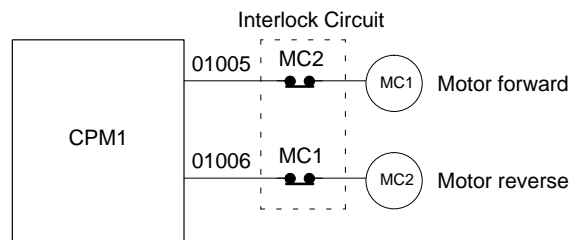

In the interlock circuit above, MC1 and MC2 can't be ON at the same time even if CPM1 outputs 01005 and 01006 are both ON (an incorrect PC operation).

### 3-1-3 Power Supply Voltage



#### Caution

Use the power supply voltages indicated in *Section 2 Unit Specifications and Components*. Failure to adhere to the specifications may result in fire. In places where power supply conditions are poor, take steps to ensure that power is supplied at the rated voltage. Be sure to adhere to safety precautions, such as providing breakers to prevent short circuits in external wiring. When conducting any of the following operations, turn OFF the power to the PC. Electrocution, product damage and malfunction may result.

- Connecting or disconnecting Expansion I/O Units and CPU Units.
- Assembling Units
- Connecting cables and wiring.

### 3-1-4 CPM1 Power Interruptions

#### Supply Voltage Drop

When the supply voltage falls below 85% of the rated value, the PC stops and the output goes OFF.

#### Momentary Power Failure Detection

A momentary power failure lasting less than 10 ms with an AC power supply and 2 ms with a DC power supply is not detected and the CPU Unit continues to operate.

A momentary power failure lasting longer than 10 ms with an AC power supply and 2 ms with a DC power supply may or may not be detected in an uncertain area.

When a momentary power failure is detected, the CPU Unit stops operating and the output goes OFF.

**Automatic Restart**

When the supply voltage recovers to a value higher than 85% of the rated value, operations resumes automatically.

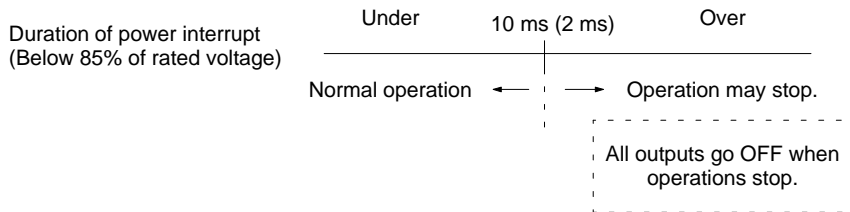

**Note** The CPM1 may repeat stop/start operations if the supply voltage of less than 85% of the rated value gradually goes up or down. If this affects the equipment, etc., provide a protection circuit which shuts off the output if the supply voltage is not above the rated value.

**Time Up to the Start of Operation**

The time from when the power supply is turned on to when the operation starts varies depending on the operation conditions such as power supply voltage, configuration, ambient temperature, etc. The minimum time is approximately 300 ms.

## 3-2 Selecting an Installation Site

The CPM1 is resistant to harsh conditions and highly reliable, but installing the PC in a favorable site will maximize its reliability and operating lifetime.

 **Caution** Be sure to install the CPM1 correctly, as outlined in this manual. Failure to do so may result in Unit malfunction.

### 3-2-1 Installation Site Conditions

**Note** Do not install the CPM1 under any of the following conditions.

- Locations subject to direct sunlight.
- Locations subject to a temperature below 0°C or over 55°C.
- Locations subject to a humidity below 10% or over 90%.
- Locations subject to condensation as the result of severe changes in temperature.
- Locations subject to corrosive or flammable gases.
- Locations subject to dust (especially iron dust) or salts.
- Locations subject to shock or vibration.
- Locations subject to exposure to water, oil, or chemicals.

Be sure that the conditions at the installation site conform to the CPM1's general specifications. Refer to 2-1-1 *General Specifications* for details.

**Note** Provide proper shielding when installing in the following locations:

- Locations subject to static electricity or other sources of noise.
- Locations subject to strong electromagnetic fields.
- Locations subject to possible exposure to radiation.
- Locations near to power supply lines.



### 3-2-2 Panel/Cabinet Installation

Consider PC operation, maintenance, and surrounding conditions when installing the CPM1 in a panel or cabinet.

#### Overheating

The operating temperature range for the CPM1 is 0°C to 55°C. Be sure that there is adequate ventilation for cooling.

- Allow enough space for air circulation.
- Do not install the CPM1 above equipment that generates a large amount of heat, such as heaters, transformers, or large resistors.
- Install a cooling fan or system when the ambient temperature exceeds 55°C.

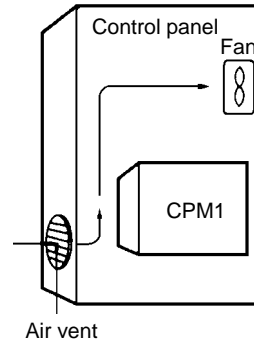

#### Electrical Noise

Power lines and high-voltage equipment can cause electrical noise in the PC.

- Do not install the CPM1 in a panel or cabinet with high-voltage equipment.
- Allow at least 200 mm between the CPM1 and nearby power lines.

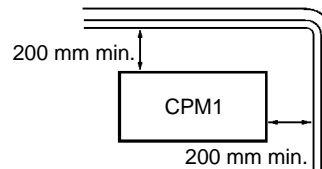

#### Accessibility

Ensure that the CPM1 can be accessed for normal operation and maintenance.

- Provide a clear path to the CPM1 for operation and maintenance. High-voltage equipment or power lines could be dangerous if they are in the way during routine operations.
- The PC will be easiest to access if the panel or cabinet is installed about 3 to 5 feet off of the floor.

## 3-3 Installing the CPM1

### 3-3-1 CPM1 Orientation

The CPM1 must be installed in the position shown below to ensure adequate cooling.

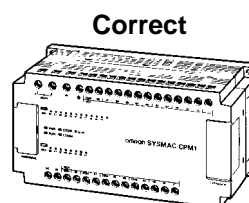

Do not install the CPM1 in either of the following positions.

Incorrect

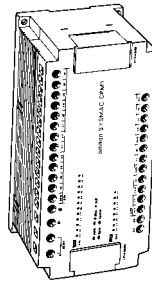

Incorrect

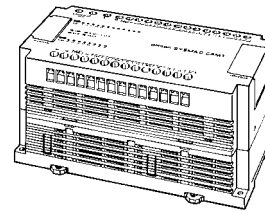

### 3-3-2 CPM1 Installation

The CPM1 can be installed on a horizontal surface or on a DIN track.

#### Surface Installation

Use the following pattern when installing a CPM1 on a horizontal surface.

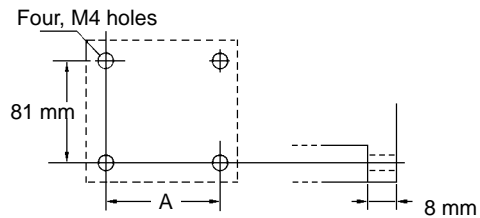

Use M4 dia. x 15 screws.

The width (A) between the mounting holes depends on the CPM1 model.

Model number	Width (A)
CPM1-10CDR-□ CPU Unit	121 mm
CPM1-20CDR-□ CPU Unit	171 mm
CPM1-30CDR-□ CPU Unit CPM1-30CDR-□-V1 CPU Unit (see note)	221 mm
CPM1-20EDR Expansion I/O Unit	171 mm
RS-232C Adapter	21 mm
RS-422 Adapter	21 mm

Use the following pattern when installing a CPM1 PC and Communications Adapter on a horizontal surface.

**Note** CPM1-30CDR-□-V1 will be available soon

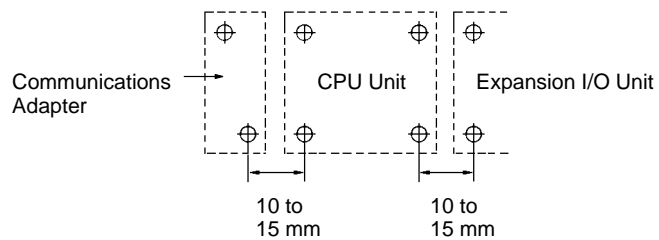

DIN Track Installation

The CPM1 can be installed on a 35-mm DIN Track.

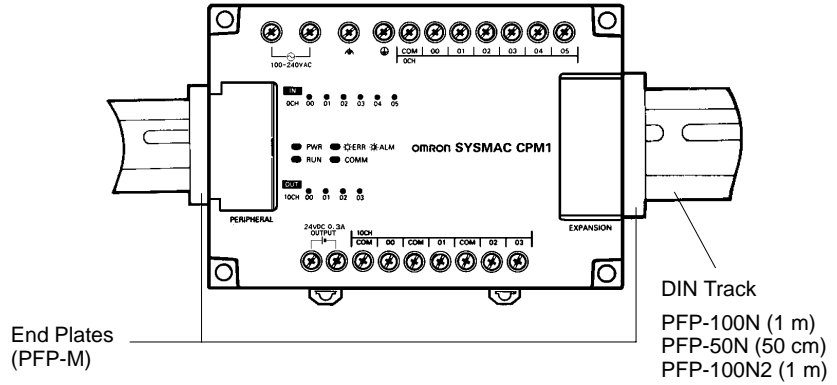

Installation

Lower the CPM1 so that the notch on the back of the PC catches the top of the DIN Track. Push the PC forward until the lock snaps into place.

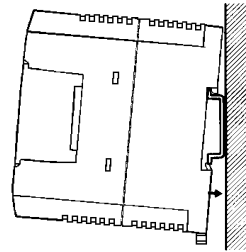

Removal

Pry the lock down with a standard screwdriver and pivot the PC upward to remove it.

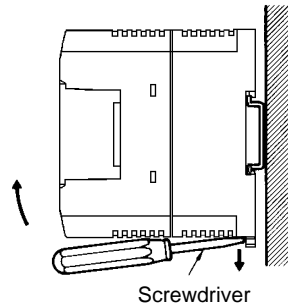

### 3-3-3 Connecting an Expansion I/O Unit

A single Expansion I/O Unit can be connected to the CPM1's CPU Unit. Use the following procedure when connecting an Expansion I/O Unit.

- 1, 2, 3... 1. Remove the cover from the CPU Unit's Expansion I/O Unit Connector.

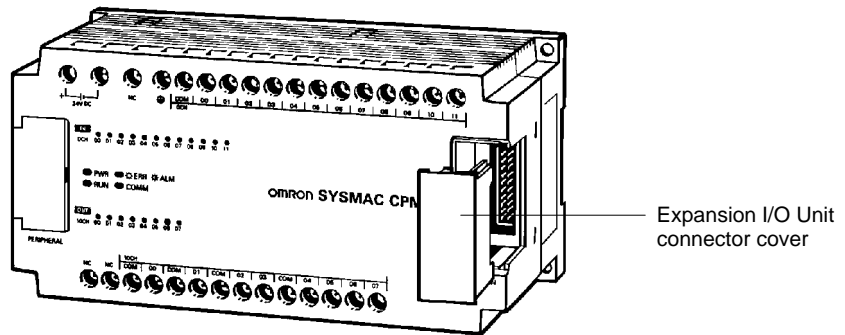

2. Insert the Expansion I/O Unit's Connecting Cable into the CPU Unit's Expansion I/O Unit Connector.

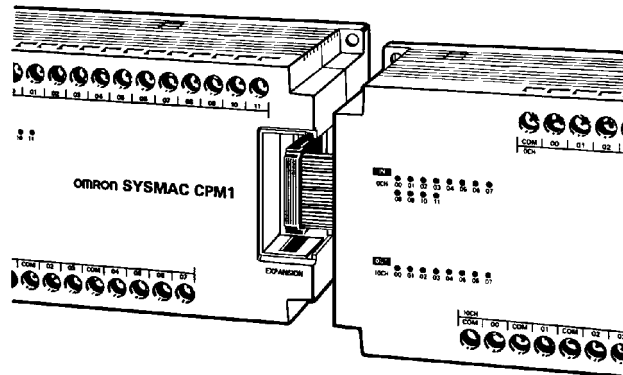

3. Replace the cover on the CPU Unit's Expansion I/O Unit Connector.

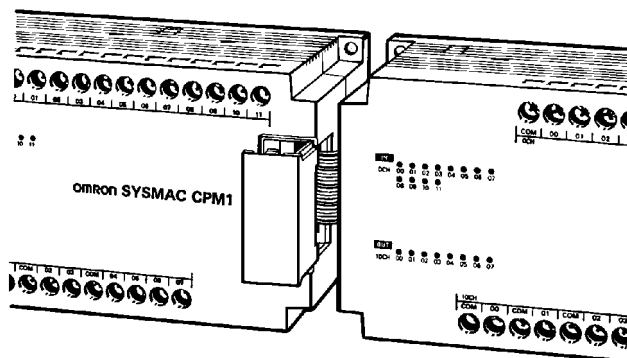

### 3-4 Wiring and Connections

This section provides basic information on wiring the Power Supply Unit and Expansion I/O Units, and on connecting Peripheral Devices.

#### 3-4-1 General Precautions for Wiring

**I/O Line Noise**

Do not run CPM1 I/O lines in the same duct or conduit as power lines.

**Caution** Attach the dustproof label provided before wiring. If scraps of wire get inside the Unit, malfunction will result. After completing wiring be sure to remove the label to avoid overheating.

**Hanging Ducts**

Leave at least 300 mm between the power cables and the I/O or control wiring, as shown in the following diagram.

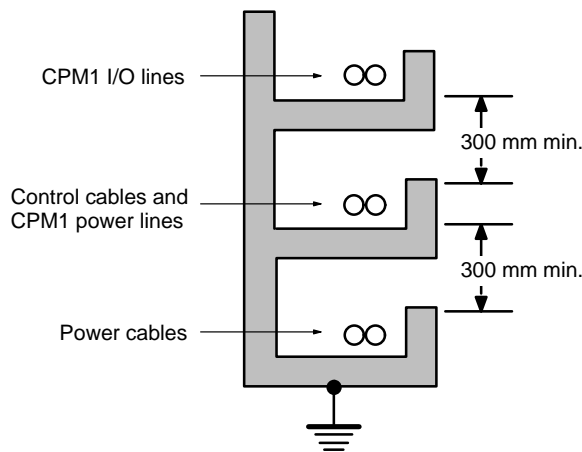

**Floor Ducts**

Leave at least 200 mm between the wiring and the top of the duct, as shown in the following diagram.

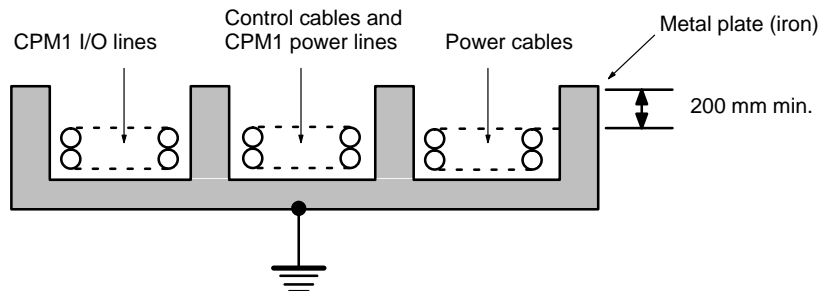

**Conduit**

Separate the CPM1 I/O lines, power and control lines, and power cables, as shown in the following diagram.

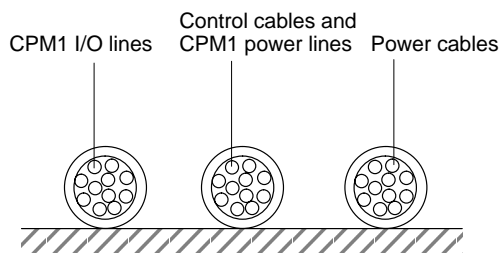

**Grounding**

Be sure to ground the functional earth and protective earth terminals together to less than 100 Ω in order to protect against electric shock and incorrect operation from electrical noise. Be sure to use a wire of at least 1.25 mm<sup>2</sup> for grounding.

**Caution** When installing the Units, always connect to a class-3 (to 100 Ω or less) ground. Otherwise, an electric shock may occur.

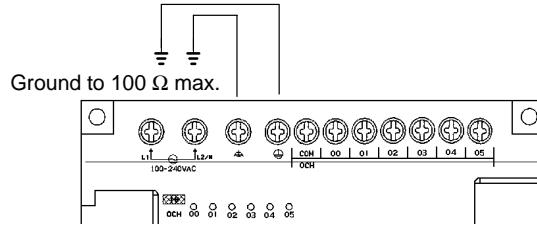

**Note** Disconnect the functional earth terminal when performing withstand voltage tests.

**Crimp Connectors**

Always use crimp connectors for the CPM1's power lines and I/O lines or else use a single-wire line (instead of a stranded wire). Stray wire strands could accidentally short out.

Use M3 terminal screws and tighten the screws securely (0.5 N • m).

Recommended Terminal: Use the terminal shown below. Round terminals cannot be used.

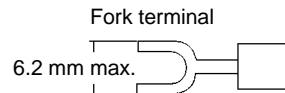

**3-4-2 Power Supply Wiring**

**100- to 240-VAC Power Supply**

Wire a separate circuit for the CPM1's power supply circuit so that there isn't a voltage drop from the inrush current that flows when other equipment is turned on.

When several CPM1 PCs are being used, it is recommended to wire the PCs on separate circuits to prevent a voltage drop from the inrush current or incorrect operation of the circuit breaker.

Use twisted power supply wires to prevent noise from the power supply lines. Adding a 1:1 isolating transformer reduces electrical noise even further.

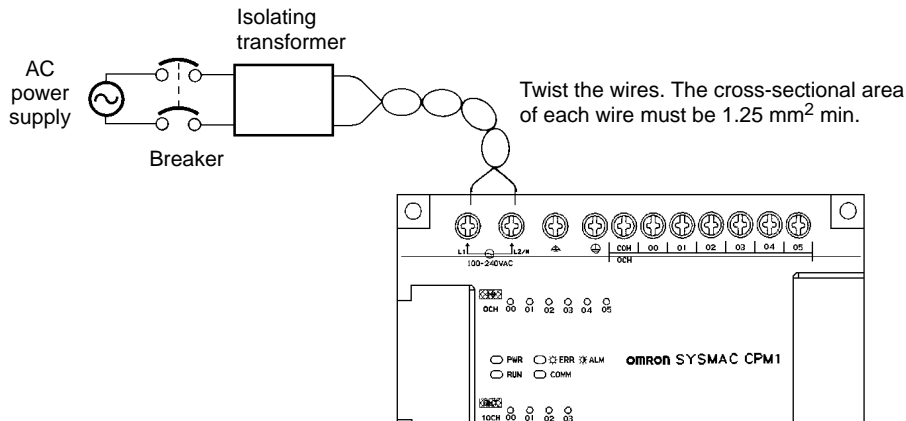

**Caution** Tighten the terminal block screws of the AC Power Supply to the torque of 0.5 N • m. Loose screws may result in burning or malfunction.

24-VDC Power Supply

Use a DC power supply with sufficient capacity and low ripple.

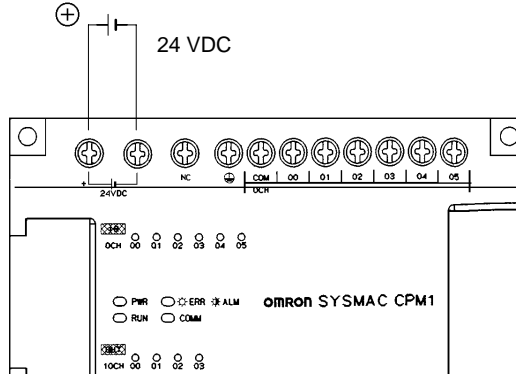

**Caution**

Do not perform a dielectric test on a DC-type CPU Unit. Use the Power Supply provided with double insulation or reinforced insulation for conforming to the EC Directives (Low-voltage Directives).

3-4-3 Input Wiring

Wire the inputs to the CPM1's CPU Unit and Expansion I/O Unit as shown in the following diagrams. Use crimp connectors or single-wire lines (not stranded wire) to connect to the PC. The power supply output terminals can be used with AC-type CPU Units.

CPM1-10CDR-□ CPU Units

An AC-type CPU Unit is shown. DC-type CPU Units don't have power supply outputs.

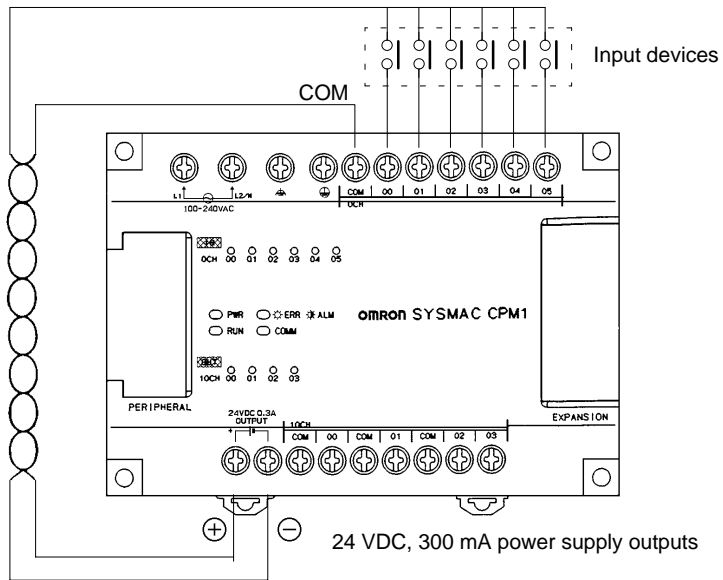

CPM1-20CDR-□ CPU Units and CPM1-20EDR Expansion I/O Unit

This diagram shows the input configuration for CPM1-20CDR-□ CPU Units and CPM1-20EDR Expansion I/O Unit.

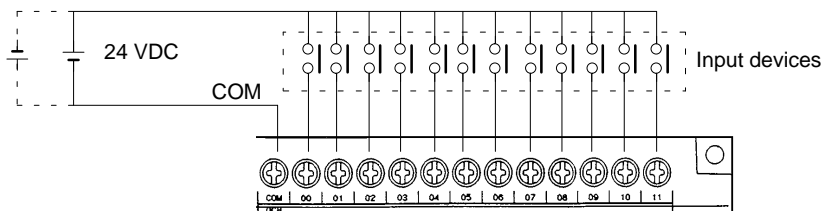

**CPM1-30CDR-□ CPU Units** This diagram shows the input configuration for CPM1-30CDR-□ CPU Units.

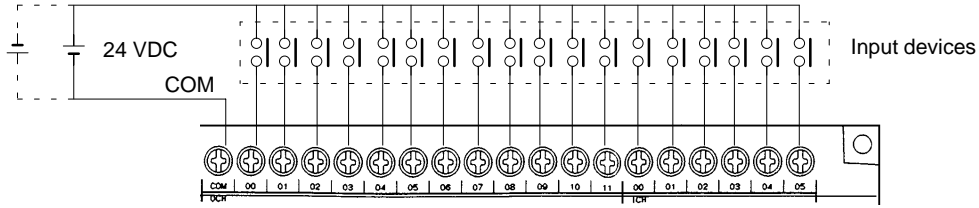

**Input Devices** The following table shows how to connect various input devices.

Device	Circuit Diagram
Relay output	
NPN open collector	
NPN current output	<p>Use the same power supply for the input and sensor.</p>
PNP current output	
Voltage output	



**Leakage Current (24 VDC)**

A leakage current can cause false inputs when using 2-wire sensors (proximity switches or photoelectric switches) or limit switches with LEDs.

False inputs won't occur if the leakage current is less than 1.0 mA (2.5 mA for IN00000 to IN00002), but if the leakage current exceeds these values, insert a bleeder resistor in the circuit to reduce the input impedance, as shown in the following diagram.

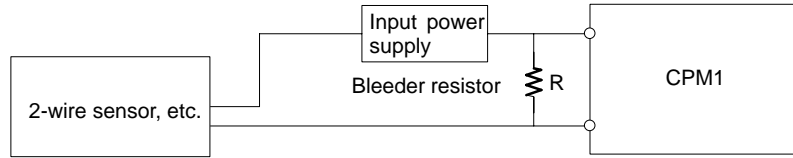

I: Device's leakage current (mA)                      L<sub>C</sub>: CPM1's input impedance (kΩ)  
 R: Bleeder resistance (kΩ)                              I<sub>C</sub>: CPM1's input current (mA)  
 W: Bleeder resistor's power rating (W)              E<sub>C</sub>: CPM1's OFF voltage (V) = 5.0 V

$$R = \frac{L_C \times 5.0}{I \times L_C - 5.0} \text{ k}\Omega \text{ max.} \quad W = \frac{2.3}{R} \text{ W min.}$$

The equations above were derived from the following equations:

$$I \times \frac{R \times \frac{\text{Input voltage (24)}}{\text{Input Current (I}_C)}}{R + \frac{\text{Input voltage (24)}}{\text{Input Current (I}_C)}} \leq \text{OFF voltage (E}_C : 5.0)$$

$$W \leq \frac{\text{Input voltage (24)}}{R} \times \text{Input voltage (24)} \times \text{tolerance (4)}$$

Refer to 2-1-3 I/O Specifications for details on the values L<sub>C</sub>, I<sub>C</sub>, and E<sub>C</sub>. The input impedance, input current, and OFF voltage may vary depending on the input being used. (IN00000 through IN00002 have different values.)

**Inductive Loads**

When connecting an inductive load to an input, connect a diode in parallel with the load. The diode should satisfy the following requirements:

- 1, 2, 3...
1. Peak reverse-breakdown voltage must be at least 3 times the load voltage.
  2. Average rectified current must be 1 A.

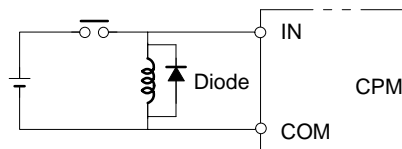

**3-4-4 Output Wiring**

Wire the outputs to the CPM1's CPU Unit and Expansion I/O Unit as shown in the following diagrams. Use crimp connectors or single-wire lines (not stranded wire) to connect to the PC. The power supply output terminals can be used with AC-type CPU Units.

- Always use single wire or attach crimp connectors if a stranded wire is used.
- Don't exceed the output capacity or the maximum common current. Refer to 2-1-3 I/O Specifications for details.

Item	Specification
Output capacity	2 A (250 VAC or 24 VDC)
Max. common capacity	4 A/common

**CPM1-10CDR-□ CPU Units**

An AC-type CPU Unit is shown. DC-type CPU Units don't have power supply outputs.

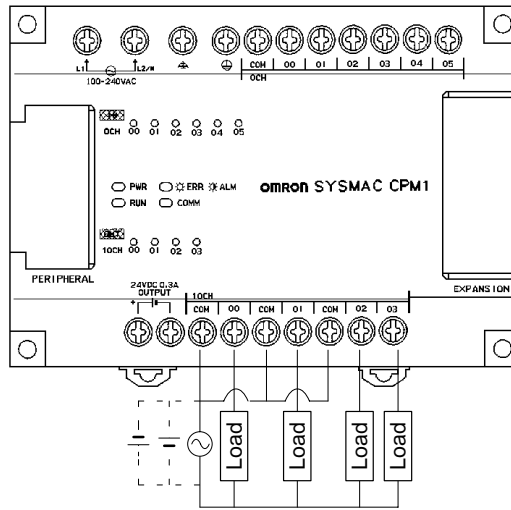

**CPM1-20CDR-□ CPU Units and CPM1-20EDR Expansion I/O Unit**

This diagram shows the output configuration for CPM1-20CDR-□ CPU Units and CPM1-20EDR Expansion I/O Unit.

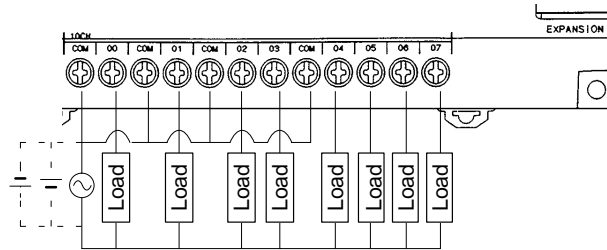

**CPM1-30CDR-□ CPM1-30CDR-□-V1 CPU Units**

This diagram shows the output configuration for CPM1-30CDR-□ or CPM1-30CDR-□-V1 (Available soon) CPU Units.

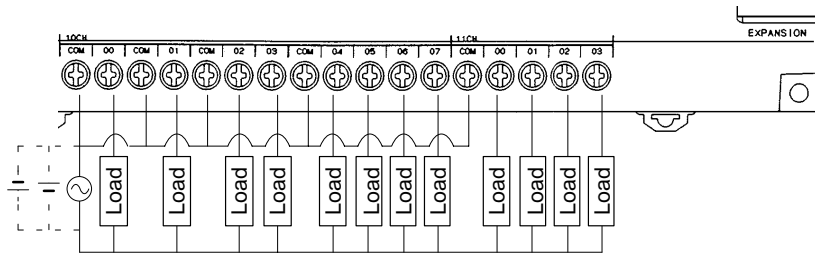

**Output Wiring Precautions**

Observe the following precautions to protect the PC's internal components.

**Output Short Protection**

The output or internal circuitry might be damaged when the load connected to an output is short-circuited, so it is recommended to install protective fuses in the output circuits.

**Inductive Loads**

When connecting an inductive load to an input, connect a surge protector or diode in parallel with the load.

The surge protector's components should have the following ratings:

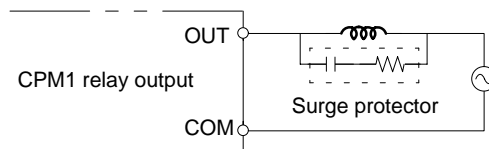

The diode should satisfy the following requirements:

- Peak reverse-breakdown voltage must be at least 3 times the load voltage.
- Average rectified current must be 1 A.

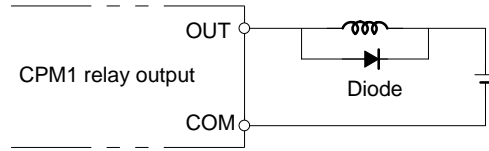

### 3-4-5 Conformance to EMC Directives

Each CPM1 PC conforms to the Common Emission Standards (EN50081-2, established in June 1993) of the EMC Directives. However, the noise generated when the PC is switched ON or OFF using the relay output may not satisfy these standards. In such a case, a noise filter must be connected to the load side or other appropriate countermeasures must be provided external to the PC.

Countermeasures taken to satisfy the standards vary depending on the devices on the load side, wiring, configuration of machines, etc. Following is an example of a countermeasure for reducing the generated noise.

#### Countermeasures

(Refer to EN50081-2 for more details.)

Countermeasures are not required if the frequency of load switching for the whole system with the PC included is less than 5 times per minute.

Countermeasures are required if the frequency of load switching for the whole system with the PC included is more than 5 times per minute.

**Countermeasure Examples**

When switching an inductive load, connect an surge protector, diodes, etc., in parallel with the load or contact as shown below.

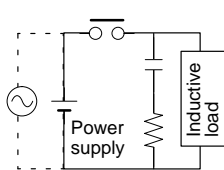
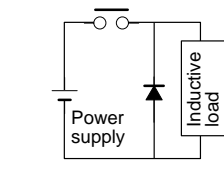
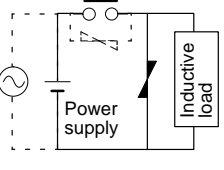
Circuit	Current		Characteristic	Required element
	AC	DC		
<p>CR method</p> 	Yes	Yes	<p>If the load is a relay or solenoid, there is a time lag between the moment the circuit is opened and the moment the load is reset.</p> <p>If the supply voltage is 24 or 48 V, insert the surge protector in parallel with the load. If the supply voltage is 100 to 200 V, insert the surge protector between the contacts.</p>	<p>The capacitance of the capacitor must be 1 to 0.5 <math>\mu\text{F}</math> per contact current of 1 A and resistance of the resistor must be 0.5 to 1 <math>\Omega</math> per contact voltage of 1 V. These values, however, vary with the load and the characteristics of the relay. Decide these values from experiments, and take into consideration that the capacitance suppresses spark discharge when the contacts are separated and the resistance limits the current that flows into the load when the circuit is closed again.</p> <p>The dielectric strength of the capacitor must be 200 to 300 V. If the circuit is an AC circuit, use a capacitor with no polarity.</p>
<p>Diode method</p> 	No	Yes	<p>The diode connected in parallel with the load changes energy accumulated by the coil into a current, which then flows into the coil so that the current will be converted into Joule heat by the resistance of the inductive load.</p> <p>This time lag, between the moment the circuit is opened and the moment the load is reset, caused by this method is longer than that caused by the CR method.</p>	<p>The reversed dielectric strength value of the diode must be at least 10 times as large as the circuit voltage value.</p> <p>The forward current of the diode must be the same as or larger than the load current.</p> <p>The reversed dielectric strength value of the diode may be two to three times larger than the supply voltage if the surge protector is applied to electronic circuits with low circuit voltages.</p>
<p>Varistor method</p> 	Yes	Yes	<p>The varistor method prevents the imposition of high voltage between the contacts by using the constant voltage characteristic of the varistor. There is time lag between the moment the circuit is opened and the moment the load is reset.</p> <p>If the supply voltage is 24 or 48 V, insert the varistor in parallel with the load. If the supply voltage is 100 to 200 V, insert the varistor between the contacts.</p>	---

When switching a load with a high inrush current such as an incandescent lamp, suppress the inrush current as shown below.

**Countermeasure 1**

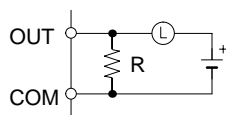

Providing a dark current of approx. one-third of the rated value through an incandescent lamp

**Countermeasure 2**

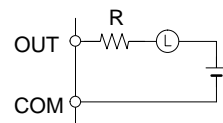

Providing a limiting resistor

### 3-4-6 Peripheral Device Connection

The CPM1 CPU Unit can be connected to a C200H-PRO27-E Programming Console with a standard C200H-CN222 (2 m) or C200H-CN422 (4 m) Connecting Cable. The CPM1 CPU Unit can be also connected to a CQM1-PRO01-E. The CQM1-PRO01-E is provided with a 2-m Connecting Cable.

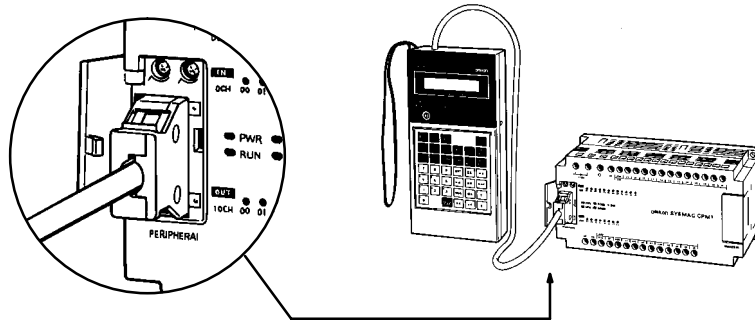

### 3-4-7 Host Link Connections

Host Link is a command/response communications system in which commands are transmitted from the host computer and corresponding responses are returned from the destination PCs. Host Link commands can be used to read/write data in PC data areas and read/write PC settings.

#### 1:1 Host Link Connection

The CPM1 CPU Unit can be connected to an IBM PC/AT compatible computer or a Programmable Terminal with an RS-232C Adapter, as shown in the following diagram.

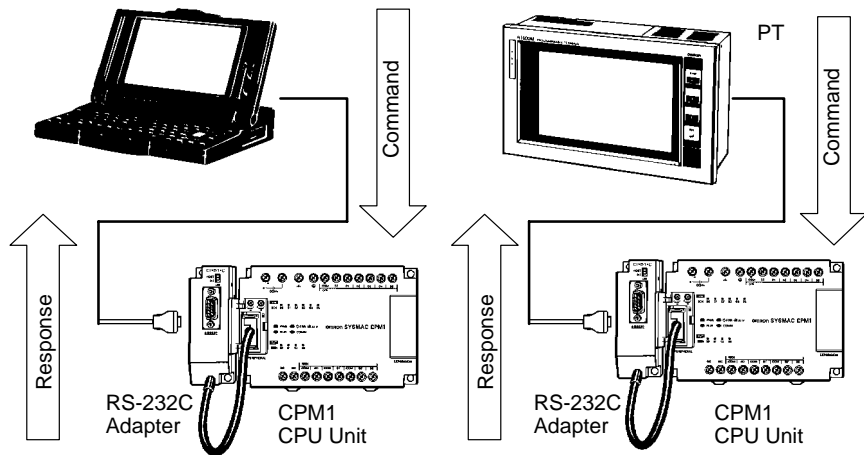

The following diagram shows the wiring in the RS-232C cable used to connect a CPM1 to a host computer or Programmable Terminal.

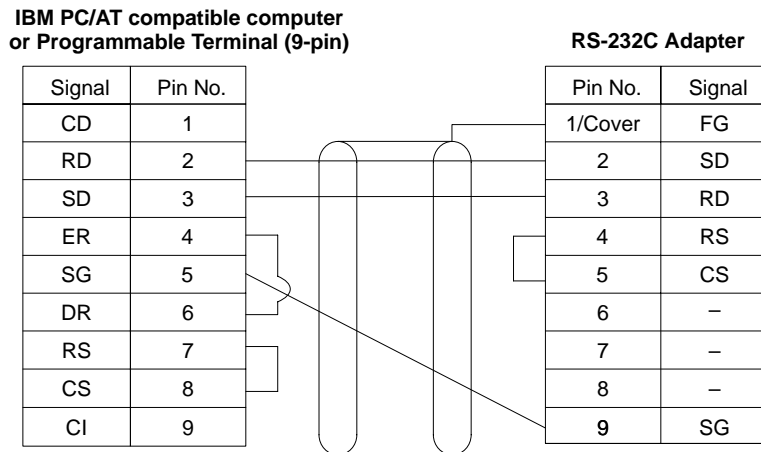

**Note** When the CPM1 is connected to a host computer, set the RS-232C Adapter's mode setting switch to "HOST."

**1:n Host Link Connection** Up to 32 CPU Units (CPM1 only) can be connected to an IBM PC/AT compatible computer or a Programmable Terminal with a B500-AL004 Link Adapter and RS-422 Adapters, as shown in the following diagram.

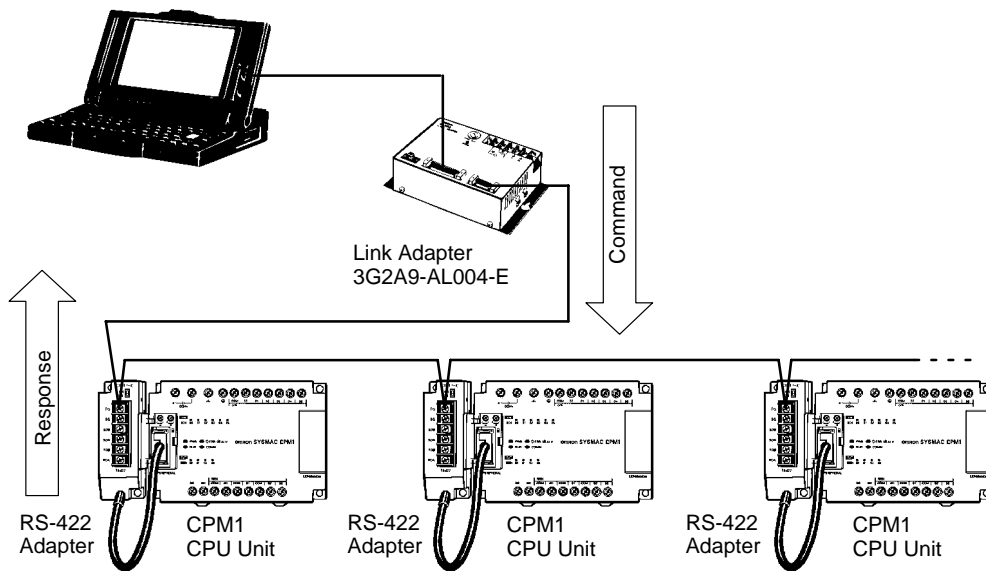

The following diagram shows the wiring in the RS-422 cables used to connect CPM1 PCs to a B500-AL004 Link Adapter. In both the Link Adapter/RS-422 Adapter connections and the RS-422 Adapter/RS-422 Adapter connections, connect the SG, RDA, RDB, SDA, and SDB terminals to the same terminals in the other Adapter.

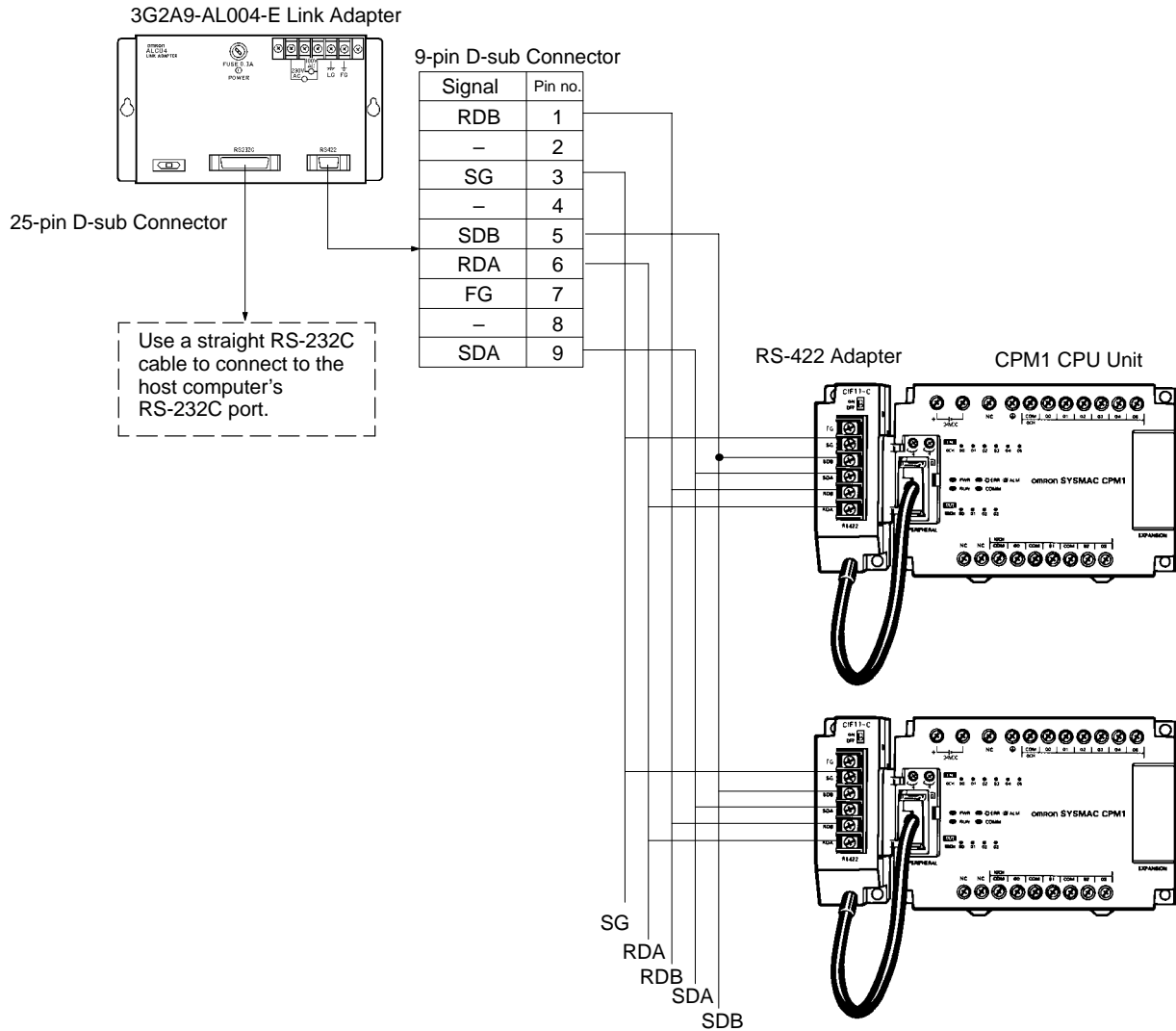

- Note**
1. The maximum length of the RS-422 cable should be 500 m.
  2. Set the termination resistance switch to “ON” (upper side) for the Link Adapters on both ends of the Host Link system and for the RS-422 Adapter.

Always use crimp connectors when wiring the RS-422 Adapters. Use M3 terminal screws and tighten the screws securely (0.5 N • m).

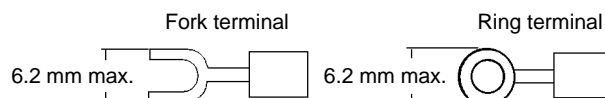

### 3-4-8 One-to-one PC Connections

A CPM1 can be linked to a CPM1, CQM1, or C200HS PC through an RS-232C Adapter. One PC acts as the Master and the other as the Slave to link up to 256 bits in the LR area (LR 0000 to LR 1515).

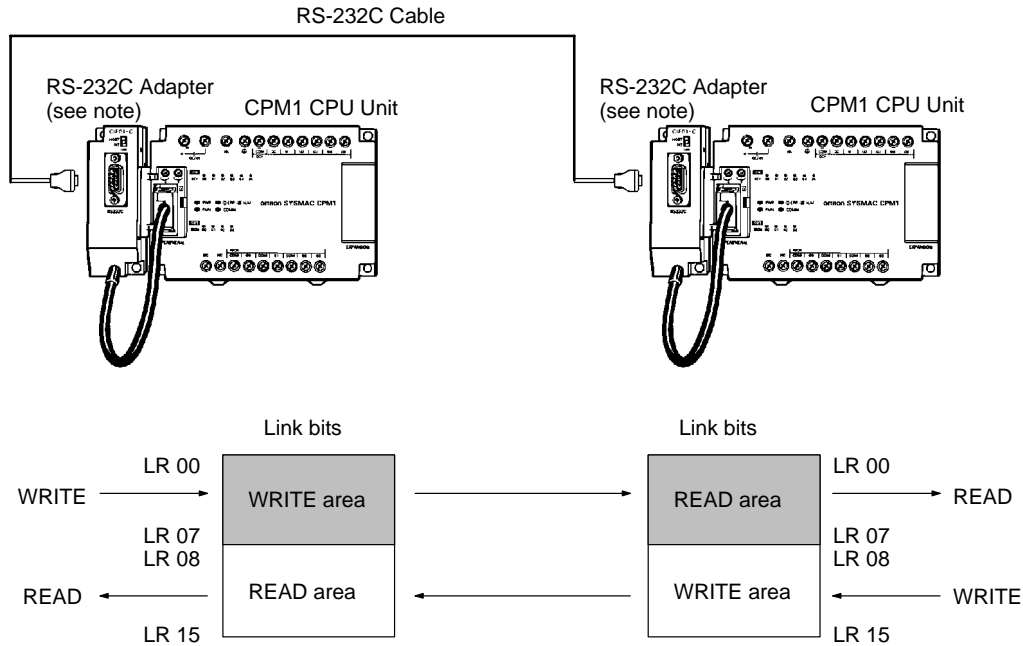

**Note** One-to-one PC connections can only be used when the RS-232C Adapter (CPM1-CIF01) is connected.

Set the DIP switch of the RS-232C Adapter (CPM1-CIF01) to the NT (bottom) side.

The following diagram shows the wiring in the RS-232C cable used to connect a CPM1 to another PC.

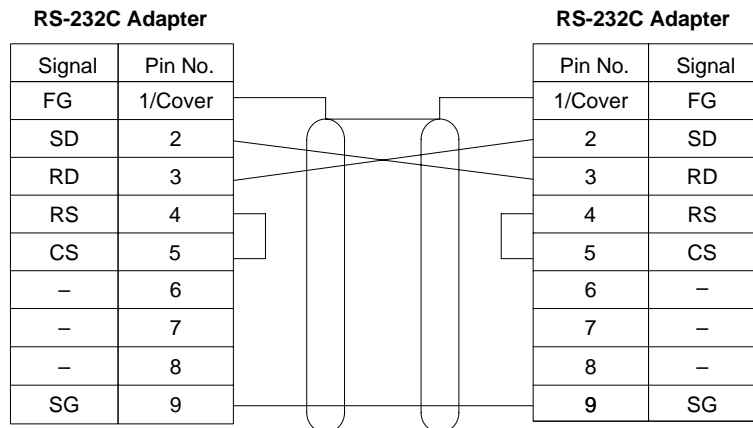



### 3-4-9 NT Link Connections

High-speed communications can be achieved by providing a direct access through the use of the NT Link between the CPM1 and Programmable Terminal.

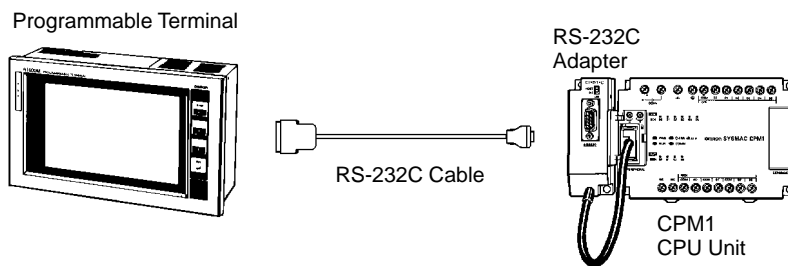

**Note** The NT Link can only be used when the RS-232C Adapter (CPM1-CIF01) is connected.

Set the DIP switch of the RS-232C Adapter (CPM1-CIF01) to the NT (bottom) side.

The following diagram shows the wiring in the RS-232C cable used to connect a CPM1 to a Programmable Terminal.

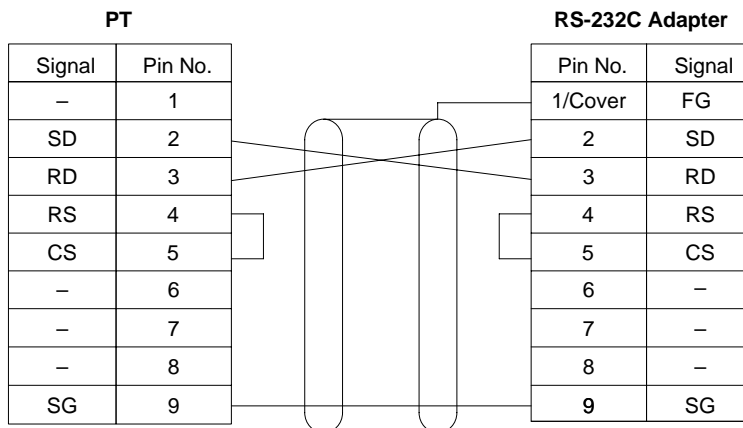

# SECTION 4

## Using Peripheral Devices

This section outlines the operations possible with the SYSMAC Support Software (SSS) and the Programming Consoles. Actual SSS operating procedures are provided in the *SSS Operation Manual: C-series PCs*. Programming Console connection and operating procedures are provided in this section.

4-1	Support Software Capabilities .....	48
4-1-1	SSS System Setup .....	48
4-1-2	CPM1 Restrictions and Precautions .....	48
4-1-3	Offline Operations .....	49
4-1-4	Online Operations .....	52
4-1-5	Offline and Online Operations .....	54
4-2	Using a Programming Console .....	55
4-2-1	Compatible Programming Consoles .....	55
4-2-2	Connecting the Programming Console .....	56
4-2-3	Preparation for Operation .....	57
4-2-4	Entering the Password .....	57
4-2-5	Changing the CPM1's Mode .....	58
4-3	Programming Console Operations .....	59
4-3-1	Overview .....	59
4-3-2	Clearing Memory .....	60
4-3-3	Reading/Clearing Error Messages .....	61
4-3-4	Buzzer Operation .....	61
4-3-5	Setting and Reading a Program Memory Address .....	62
4-3-6	Instruction Search .....	62
4-3-7	Bit Operand Search .....	63
4-3-8	Inserting and Deleting Instructions .....	63
4-3-9	Entering or Editing Programs .....	65
4-3-10	Checking the Program .....	68
4-3-11	Bit, Digit, Word Monitor .....	68
4-3-12	Differentiation Monitor .....	70
4-3-13	Binary Monitor .....	70
4-3-14	3-Word Monitor .....	71
4-3-15	Signed Decimal Monitor .....	72
4-3-16	Unsigned Decimal Monitor .....	72
4-3-17	3-Word Data Modification .....	72
4-3-18	Changing Timer, Counter SV .....	73
4-3-19	Hexadecimal, BCD Data Modification .....	74
4-3-20	Binary Data Modification .....	75
4-3-21	Signed Decimal Data Modification .....	75
4-3-22	Unsigned Decimal Data Modification .....	76
4-3-23	Force Set, Reset .....	77
4-3-24	Clear Force Set/Reset .....	77
4-3-25	Hex-ASCII Display Change .....	78
4-3-26	Displaying the Cycle Time .....	78
4-4	Programming Example .....	78
4-4-1	Preparatory Operations .....	78
4-4-2	Example Program .....	80
4-4-3	Programming Procedures .....	81
4-4-4	Checking the Program .....	83
4-4-5	Test Run in MONITOR Mode .....	84

## 4-1 Support Software Capabilities

The SSS is a complete programming and control package designed for C-series and CVM1 PCs. It provides not only programming capabilities, but also advanced debugging, monitoring, and program/data management. The following tables provide only a brief introduction to the capabilities of the SSS. For further information and actual operating procedures, please refer to the *SYSMAC Support Software Operation Manual: C-series*.

CPM1 programming can be performed with all versions of SSS. (Ladder Support Software (LSS) version 5.0 or higher can also be used.)

In addition, the SYSMAC-CPT can be used for programming the CPM1. Refer to the *SYSMAC-CPT Support Software Quick Start Guide (W332)* and *User Manual (W333)* for operation procedures. When programming the CPM1 using the SYSMAC-CPT, be sure to set the "PC model" on the Support Software to "CPM1 (CPM1A)."

### 4-1-1 SSS System Setup

Set the PC Model to "CQM1" and the PC Interface to "PERIPHERAL." Follow the directions in the SSS Operating Manual for other System Setup settings.

#### PC Model

If the CPM1 PC doesn't appear as an option in the SSS's System Setup, set the PC Model to "CQM1." The CPM1 is compatible with the CQM1.

#### PC Interface

Set the PC Interface to the Peripheral Device Port by selecting "PERIPHERAL" from the submenu. After selecting the Peripheral Device Port, set the communications baud rate to 9,600 baud.

### 4-1-2 CPM1 Restrictions and Precautions

When programming the CPM1, set the PC Model on the SSS to "CQM1." Heed the following restrictions when programming the CPM1.

#### Programming Check

Since the data area of the CQM1 is larger than that of the CPM1, some parts of the area cannot be checked as the CPM1 PC. Pay careful attention to the usable data area when programming.

**Note** If a program that contains addresses not supported by the CPM1 are transferred to the CPM1, a memory error will occur when operation is begun and AR 1308 will turn ON. Refer to the *Programming Manual (W228)* for differences in memory areas.

#### Memory Usage

Since the memory of the the CQM1 is larger than that of the CPM1, the displayed available memory capacity is larger than the actual available memory capacity. Pay careful attention to the actual available memory capacity when programming.

#### Expansion Instructions

When a program is transferred after changing the assignment of function codes for the 18 expansion instructions, a message to "Turn on the DIP switch of the PC and execute again" is displayed. Change the assignment of the function codes for the expansion instructions to the default settings before programming.

The default settings for the CQM1 are as shown in the following table.

Function code	Mnemonic	Function code	Mnemonic
17	ASFT	64	SPED
18	TKY	65	PULS
19	MCMP	66	SCL
47	RXD	67	BCNT
48	TXD	68	BCMP
60	CMPL	69	STIM
61	INI	87	DSW
62	PRV	88	7SEG
63	CTBL	89	INT

### Online Editing

If unsupported addresses are set in the program for operands or set values, error messages will be displayed and the values will not be accepted.

## 4-1-3 Offline Operations

A ★ symbol indicates the operation can be performed with CVM1 PCs only

Group	Name	Description
Programming	Connect line	Draws a line between two ladder diagram objects.
	Save program	Writes all or part of the user program developed in the system work area to the data disk.
	Retrieve program	Retrieves all or part of the user program stored on a data disk to the system work area.
	Change display	Specifies the display modes for the user program.
	Search	Searches for instructions including specified operands. An address from which the search is to be started can be specified
	I/O comment	Creates I/O comments corresponding to bit addresses in the Ladder With Comments mode. In addition, reads (searches) and edits the program for comments.
	Instr comment	Creates and edits instruction comments for output instructions in the Ladder With Comments mode. (C-series PCs only)
	Block comment	Creates, reads (searches), and edits block comment in the Ladder With Comments mode.
	Edit ladder	Edits ladder diagrams using the following: <ul style="list-style-type: none"> <li>• Moving specified instruction blocks</li> <li>• Copying specified instruction blocks</li> <li>• Deleting specified instruction blocks</li> </ul>
	Edit comments	Displays I/O comments simultaneously to write, edit, and search for specified comments.
	Retrieve comments	Retrieves comments from the program stored on a data disk. The I/O comments are read to the system work area. Instruction comments (C-series PCs only) and block comments are copied to the currently displayed program.
	Memory usage	Displays the used capacity of the user program memory, the number of comments used, and the available capacity of the internal memory.
	Clear memory	Clears the user program memory. The starting address for clearing can be specified. The comment memory can also be cleared.
	Check program	Checks whether the user program contains syntax errors. The check can be performed in three levels.
★ Edit interrupt program	Used to create I/O interrupt, scheduled interrupt, power off interrupt, and power on interrupt programs. (CVM1 PCs only)	
★ Program input mode	Used to change the ladder diagram input mode between symbols and text strings. (CVM1 PCs only)	

Group	Name	Description
DM (data memory)	<b>Go To Page</b>	Displays the contents of the data memory in the system work area in pages (units of 160 words). The data can be altered with this function. (C-series PCs only)
	<b>Copy</b>	Copies the contents of the DM area of the system work area (data memory information).
	<b>Fill</b>	Writes the same data to more than one data word in the system work area data memory area.
	<b>Print</b>	Prints a specified range of DM words.
	<b>Hex <math>\longleftrightarrow</math> ASCII</b>	Specifies the display mode for the data memory contents when the work disk data memory contents are to be altered. The display mode can be hexadecimal or ASCII.
	<b>Save DM Data</b>	Writes the contents of a specified range of system work area data memory to the data disk.
	<b>Retrieve DM Data</b>	Retrieves the saved data disk data memory to the system work area DM area.
	<b>★ Read DM Address</b>	Used to display DM data from the work disk up to 160 words at a time. Displayed data can be modified. (CVM1 PCs only)
	<b>★ Switch Bank Number</b>	Used to specify the Expansion DM bank on the work disk. (CVM1 PCs only)
	<b>★ Save file</b>	Used to save file data (with an .IOM) extension from the work disk to a data disk. (CVM1 PCs only)
	<b>★ Retrieve file</b>	Use to retrieve file data (with an .IOM extension) from a data disk to the work disk. (CVM1 PCs only)
I/O Table	<b>Write I/O Table</b>	Edits the I/O table in the system work area.
	<b>Check I/O Table</b>	Checks the contents of the I/O table in the system work area.
	<b>Save I/O Table</b>	Writes the I/O table in the system work area to a data disk.
	<b>Retrieve I/O Table</b>	Retrieves the I/O table data stored on a data disk to the system work area.
	<b>★ Clear I/O Table</b>	Used to delete the I/O table from the work disk. (CVM1 PCs only)
	<b>★ Custom I/O Table SIOU</b>	Used to specify CPU Bus Unit classifications. (CVM1 PCs only)
	<b>Print I/O Table</b>	Prints an I/O table list. (C-series PCs only)

Group	Name	Description
Utility	<b>Data Area Lists</b>	Displays lists (such as used areas and cross-references) in accordance with the contents of the user program in the system work area.
	<b>Change Addresses</b>	Globally changes bit and word addresses in the user program in the system work area.
	<b>Print Lists</b>	Prints lists, ladder diagrams, and mnemonics in accordance with the contents of the user program in the system work area.
	<b>EPROM/Memory Card</b>	Writes, reads, and compares the user program between the PROM Writer/Memory Card and system work area.
	<b>Program Conversion</b>	C500 → C2000H: Converts C500-family programs to C2000H programs.  C2000H → CVM1: Converts C2000H-family programs to CVM1 programs
	<b>Create Library File</b>	Creates a library on a floppy disk or hard disk for use as an LSS data disk.
	<b>Time Chart Monitor</b>	Accesses the time chart monitor data produced online. (C-series PCs only)
	<b>Instruction Trace</b>	Accesses the instruction trace data produced online. (C-series PCs only)
	<b>Data trace</b>	Accesses the data trace data produced online.
	<b>Set Instructions</b>	Used to assign instructions to function codes in the instructions table and to save and retrieve instructions tables to and from data disk files. (C-series PCs only)
	<b>Retrieve/Save Instr</b>	Used to save and retrieve expansion instruction sets to and from data disk files. (C-series PCs only)
	<b>PC Setup</b>	Used to set the PC operating parameters in the PC Setup and to save and retrieve PC Setups to and from data disk files.
	<b>Allocate UM</b>	Used to allocate parts of the user memory area for used as a Fixed DM Area and/or I/O Comment Area. (C-series PCs only)
	<b>★ Edit PC ID</b>	Used to create, edit, search for, or print PC IDs (names). (CVM1 PCs only)
	<b>★ Compare Programs</b>	Used to compare a program in a data disk with the program in the work file in the computer. (CVM1 PCs only)
	<b>★ Customization</b>	Used to change bit/word names, to define custom data areas, or to register HIS instructions. (CVM1 PCs only)
<b>Network Support Table</b>	Used to edit data link tables and routing tables for the SYSMAC NET and SYSMAC LINK Systems.	
File Management	<b>Directory</b>	Displays a file list. Wildcard names can be used to display only desired files.
	<b>Copy File</b>	Copies files on the same floppy disk or between different disks.
	<b>Change File Name</b>	Changes the name of a specified file.
	<b>Delete File</b>	Deletes a specified file.
	<b>LSS File Management</b>	Used to change between LSS-style data files and DOS-style data files.

## 4-1-4 Online Operations

Refer to *1-2-5 Peripheral Device Connections* for details on connecting a personal computer to the CPM1.

Group	Name	Description
Monitoring	Monitor Data	Uses the lower one third of the screen as a monitor area where bits, words, DM contents, and TIM/CNT SV/PV are monitored, forced-set/reset, and changed.
	Transfer Program	Transfers and compares the user program between the computer and PC.
	Change Display	C-series PCs Ladder W/Comments Ladder  CVM1 PCs Ladder Ladder (2 rows of comments) Ladder (4 rows of comments)
	Online Edit	Simultaneously edits the PC program and the program in the system work area.
	Read Cycle Time	Reads and displays the scan time of the PC.
	Clear Area	Clears the PC data areas such as HR, CNT, AR, and DM (to zero).
	Search	Searches for instructions (including specified operands).
	I/O Comments	Searches for I/O comments.
	Block Comments	Searches for block comments.
	Memory Usage	Displays used program memory area, the number of comments used, and the available capacity of the internal memory.
	★ Monitor Interrupt Program	Used to monitor I/O interrupt, scheduled interrupt, power off interrupt, and power on interrupt programs. (CVM1 PCs only)
	★ Program Input Mode	Used to change the ladder diagram input mode between symbols and text strings. (CVM1 PCs only)
	★ Monitor Other Node	Used to allow basic monitoring operations (I/O monitor, set/reset, PV changes, etc.) for other PCs connected to the the same network. (CVM1 PCs only)
DM	Transfer PC → Computer	Retrieves PC DM data to the system work area. (C-series PCs only)
	Transfer Computer → PC	Writes system work area DM data to the PC. (C-series PCs only)
	Transfer Verify	Compares DM data between the system work area and PC. (C-series PCs only)
	Monitor	Used to monitor DM area contents in the PC. (C-series PCs only)
	Go To Page	Reads a specified page from the DM list of the DM area in the system work area or PC. (C-series PCs only)
	★ Read DM Addr	Reads the contents of the DM area, including the specified DM address, from the work disk and displays it in the DM table. (CVM1 PCs only)
	★ Copy	Copies multiple, consecutive words of DM data to a specified destination DM address. (CVM1 PCs only)
	★ Fill	Places a specified value into multiple, consecutive words of the DM area. Filling with 0000 clears the DM words. (CVM1 PCs only)
	★ Print	Prints multiple, consecutive words of DM data. (CVM1 PCs only)
	★ HEX <-> ASCII	Specified inputs using hexadecimal or ASCII. The mode set will be displayed in the top-right of the screen. (CVM1 PCs only)
	★ Switch Bank Number	Switches editing between the standard DM and EM banks. (CVM1 PCs only)
	★ Save DM data	Saves the DM data from the work disk to the data disk or hard disk. (CVM1 PCs only)
	★ Retrieve DM data	Retrieves the DM data on the data disk or hard disk to the work disk. (CVM1 PCs only)
	★ Transfer DM	Transfers and compares DM data between the SSS and the PC. (CVM1 PCs only)

Group	Name	Description
<b>I/O Table</b>	<b>Transfer I/O Table</b>	Transfers and compares the I/O table data between the computer and PC.
	<b>Create I/O Table</b>	Registers into the PC the I/O Units mounted on the PC and then assigns the words to the Units.
	<b>Verify I/O Table</b>	Compares the I/O table registered in the PC against the I/O Units actually mounted on the PC.
	<b>★ Clear I/O Table</b>	Deletes the I/O tables (C200H and C200HS PCs only)
<b>Utility</b>	<b>File Memory/ Memory Card</b>	Displays a file memory list; transfers the file memory contents between the PC and computer or the PC and File Memory Unit; clears the file memory; saves or retrieves the file memory contents to or from a floppy disk; and edits file memory contents
	<b>Time Chart Monitor</b>	Used to execute time chart monitoring and to display, save, or retrieve results. (C-series PCs only)
	<b>Instruction Trace</b>	Used to execute instruction traces and used to display, save, or retrieve results. (C-series PCs only)
	<b>Data Trace</b>	Used to execute data traces and used to display, save, or retrieve results.
	<b>Debug</b>	Used to display the execution status of the specified program section. (C-series PCs only)
	<b>Display/Set Clock</b>	Used to read and set the internal clock in the PC. (CQM1, C200HS, or CVM1 only)
	<b>Transfer Instr</b>	Used to transfer expansion instruction set from the PC to the SSS. (C-series PCs only)
	<b>★ Custom data</b>	Used to transfer customized settings from the SSS to the PC. (CVM1 PCs only)
	<b>★ CPU Bus Unit Setup</b>	Used to set parameters for SYSMAC NET, SYSMAC LINK, and SYSMAC BUS/2 communications. (CVM1 PCs only)
	<b>PC Setup</b>	Changes the PC Setup in the PC and in the system work area and used to transfer the PC Setup between the PC the disk (save/retrieve).
	<b>★ SYSMAC BUS/2</b>	Used to manipulate SYSMAC BUS/2 Remote I/O Master Units. (CVM1 PCs only)
	<b>★ Read Error Log</b>	Used to read the current error and error logs. Also used to force-release the access right to a PC. (CVM1 PCs only)
	<b>★ Protect UM</b>	Used to protect all or part of the user program by creating passwords. Program access will not be possible to protected sections without the proper password. (CVM1 PCs only)
	<b>Network Support Tables</b>	C-series PCs: Used to input data link tables for SYSMAC NET. CVM1 PCs: Used to transfer data link tables and routing tables between Link Units, the PC, and the SSS and to compare these tables. Also used to start and start data links.
	<b>★ Network Diagnosis</b>	Used to run tests between nodes, to read node status, and to read error logs from Units for the SYSMAC NET and SYSMAC LINK Systems. Also used for SYSMAC LINK Systems to run broadcast tests and set network parameters. (CVM1 PCs only)



## 4-1-5 Offline and Online Operations

Group	Name	Description
System Setup (see note)	PC model	Specifies the model of PC that is being programmed or that is connected to the computer.
	PC Interface	C-series PCs: Specifies whether communications with the PC are performed through a SYSMAC NET Link Unit, peripheral interface, or a Host Link (RS-232C) interface and the computer port (COM1 or COM2) to use. When a Host Link Unit is used, it also specifies the port number and baud rate.  CVM1 PCs: Used to specify the communications protocol for communications with the PC, i.e., peripheral or Host Link (RS-232C) interface. The baud rate, PC unit number, parity, data length, and number of stop bits are designated.
	Network address	Specifies the network address, node number, and data code type of the SYSMAC NET Link Unit communicating with the SSS on the SYSMAC NET System. The address determines the PC to be connected to for online operations.  With CVM1 PCs this setting is also used to specify the PC being communicated with through networks when connected via a peripheral or Host Link interface.
	★ Message No.	Specifies which messages are to be displayed on the SSS from messages programmed in the PC with the MESSAGE instruction. (CVM1 PCs only)
	I/O table – UM transfer	Specifies whether the I/O table and data link tables are transferred to the user program area when the user program is transferred between the computer and PC or PROM Writer. (C-series PCs only)
	EPROM interface	Specifies the baud rate and port number of the PROM Writer connected to the computer. (C-series PCs only)
	Printer model	Specifies the printer model.
	Data disk drive	Specifies the data disk drive.
	OutBit Comment Type	Specifies whether I/O comments or instruction comments are displayed at the TIM/CNT, DIFU/DIFD, KEEP, and STEP/SNXT comment display positions. (C-series PCs only)
	Exit to DOS	Terminates SSS operation and returns to DOS.

**Note** When the SSS is operating in online mode, the only functions available on the System Setup Menu are “I/O table – UM transfer,” “Data disk drive,” and “Exit to DOS.”

## 4-2 Using a Programming Console

This section provides information on connecting and using a Programming Console. Refer to 5-4 *Programming Console Operation Errors* for details on errors that might occur during Programming Console operations.

### 4-2-1 Compatible Programming Consoles

There are two Programming Consoles that can be used with the CPM1: the CQM1-PRO01-E and the C200H-PRO27-E. The key functions for these Programming Consoles are identical.

Press and hold the Shift Key to input a letter shown in the upper-left corner of the key or the upper function of a key that has two functions. For example, the CQM1-PRO01-E's AR/HR key can specify either the AR or HR Area; press and release the Shift Key and then press the AR/HR Key to specify the AR Area.

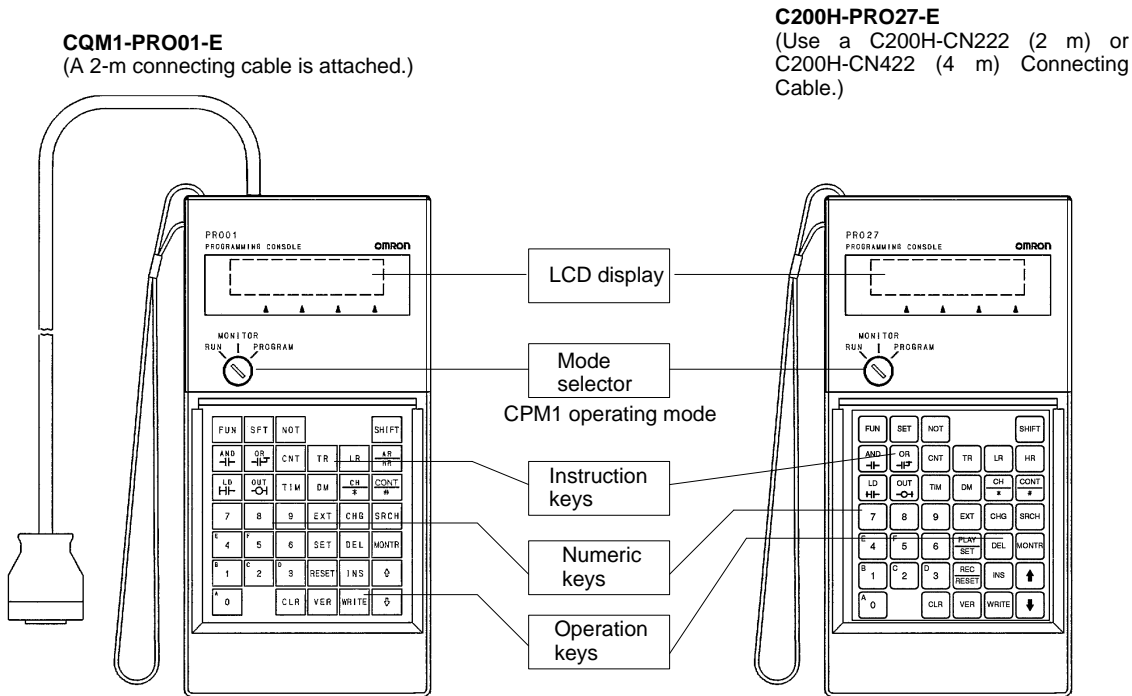

The following keys are labeled differently on the CQM1-PRO01-E and the C200H-PRO27-E, but the operation of the keys in each pair is identical.

CQM1-PRO01-E Keys	C200H-PRO27-E Keys

**Note** To specify the AR area, use SHIFT + HR Keys for the C200H-PRO27-E and use SHIFT + AR/HR Keys for the CQM1-PRO01-E.

### 4-2-2 Connecting the Programming Console

Connect the Programming Console's connecting cable to the CPM1's peripheral port, as shown below.

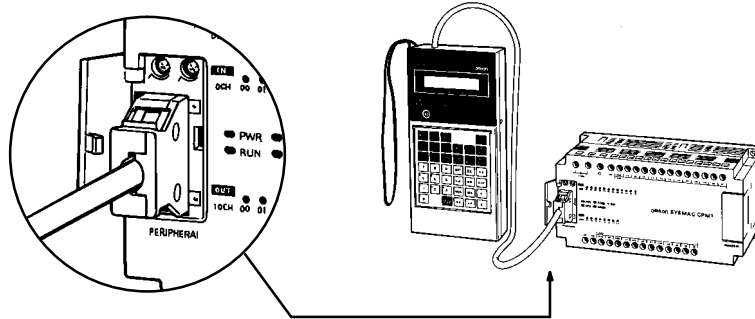

### Panel Installation

The C200H-PRO27-E Programming Console can be installed in a control panel as shown in the following diagram. (The C200H-ATT01 Mounting Bracket is sold separately.)

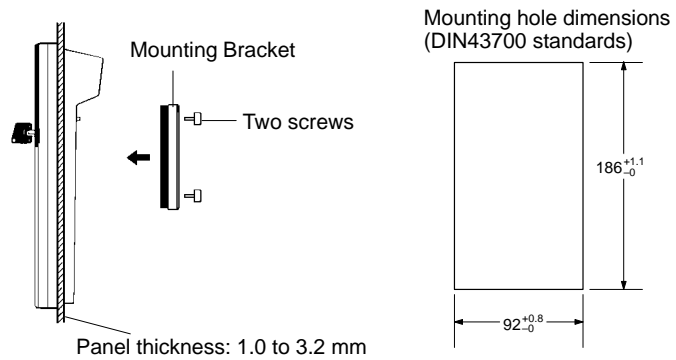

Allow at least 80 mm for the cable connector above the Programming Console.

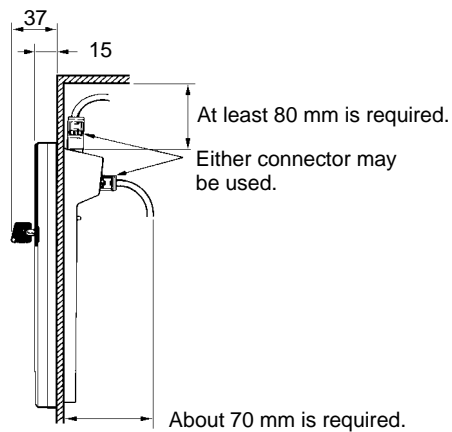

### 4-2-3 Preparation for Operation

This section describes the procedures required to begin Programming Console operation.

 **Caution** Always confirm that the Programming Console is in PROGRAM mode when turning on the PC with a Programming Console connected unless another mode is desired for a specific purpose. If the Programming Console is in RUN mode when PC power is turned on, any program in Program Memory will be executed, possibly causing a PC-controlled system to begin operation.

The following sequence of operations must be performed before beginning initial program input.

- 1, 2, 3...**
1. Insert the mode key into the Programming Console.
  2. Set the mode switch to PROGRAM mode. (The mode key cannot be removed while set to PROGRAM mode.)
  3. Turn on PC power.
  4. Confirm that the CPU Unit's POWER LED is lit and the following display appears on the Programming Console screen. (If the PC mode is not displayed, turn off and restart the power supply. If the ALM/ERR LED is lit or flashing or an error message is displayed, clear the error that has occurred.)

```
<PROGRAM>
PASSWORD!
```

5. Enter the password. See 4-2-4 *Entering the Password* for details.
6. Clear memory. Skip this step if the program does not need to be cleared. See 4-3-2 *Clearing Memory* for details.

### 4-2-4 Entering the Password

To gain access to the PC's programming functions, you must first enter the password. The password prevents unauthorized access to the program.

The PC prompts you for a password when PC power is turned on or, if PC power is already on, after the Programming Console has been connected to the PC. To gain access to the system when the "Password!" message appears, press CLR and then MONTR. Then press CLR to clear the display.

If the Programming Console is connected to the PC when PC power is already on, the first display below will indicate the mode the PC was in before the Programming Console was connected. **Ensure that the PC is in PROGRAM mode before you enter the password.** When the password is entered, the PC will shift to the mode set on the mode switch, causing PC operation to begin if the mode is set to RUN or MONITOR. The mode can be changed to RUN or MONITOR with the mode switch after entering the password.

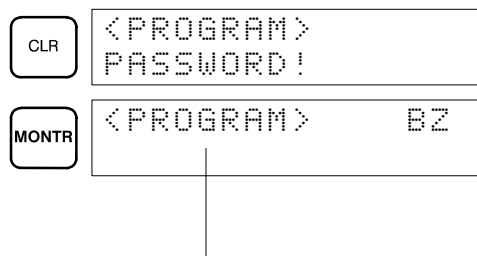

Indicates the mode set by the mode selector switch.

## 4-2-5 Changing the CPM1's Mode

Once the Programming Console has been connected, its mode switch can be used to change the CPM1's PC mode. The mode display (<PROGRAM>, <MONITOR>, or <RUN>) will appear on the Programming Console screen.

- No key operations can be performed while the mode display is displayed on the Programming Console screen. Press CLR to clear the display so that key operations can be performed.
- If the SHIFT Key is pressed while the mode switch is turned, the original display will remain on the Programming Console's screen and the mode display won't appear.
- The CPM1 will enter RUN mode automatically if a Peripheral Device such as a Programming Console isn't connected when the CPM1 is turned on.

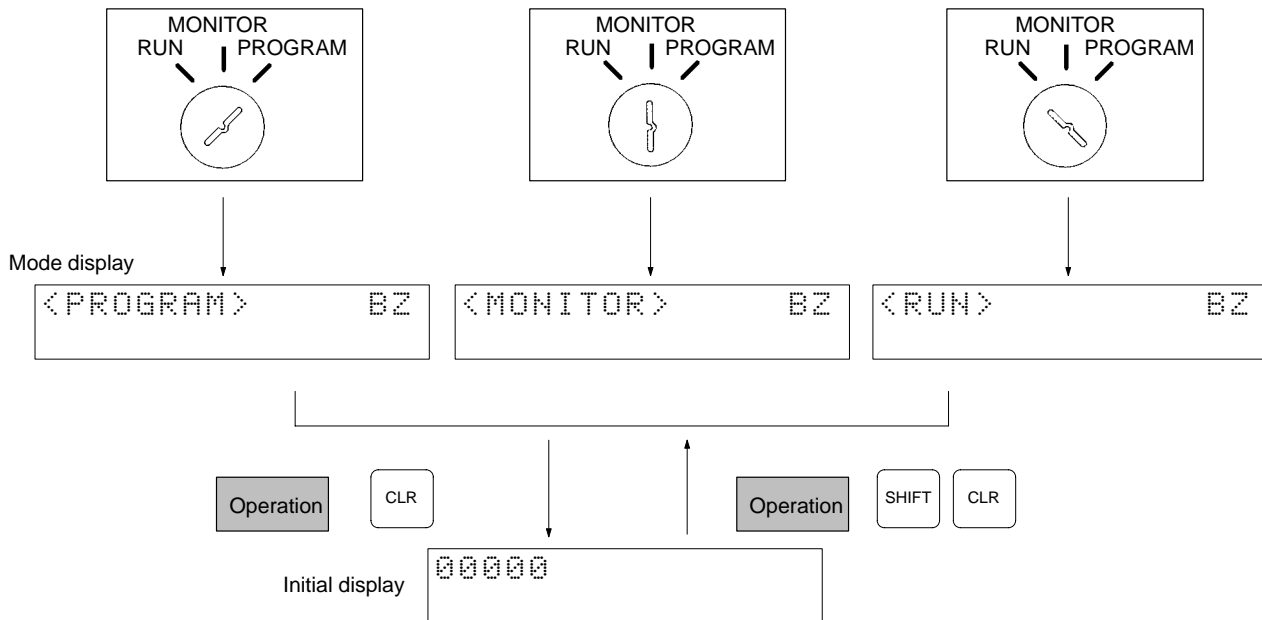

### PROGRAM Mode

The CPM1 program isn't executed in PROGRAM mode. Use PROGRAM mode to create and edit the program, clear memory, or check the program for errors.

### MONITOR Mode

The CPM1 program is executed in MONITOR mode and I/O is processed just as it is in RUN mode. Use MONITOR mode when testing the system by monitoring the CPM1's operating status, force-setting and resetting I/O bits, changing the SV/PV of timers and counters, etc.

### RUN Mode

This is the CPM1's normal operating mode. The CPM1's operating status can be monitored from a Peripheral Device, but bits can't be force-set/force-reset and the SV/PV of timers and counters can't be changed.



### Caution

Be sure to confirm that no adverse effect will occur with the equipment before changing the operating mode of the PC.

## 4-3 Programming Console Operations

### 4-3-1 Overview

The following table lists the programming and monitoring operations that can be performed from a Programming Console. Refer to the rest of this section for details on operational procedures.

Name	Function
<b>Clearing memory</b>	Clears all or part of the Program Memory and any data areas that are not read-only, as well as the contents of the Programming Console's memory.
<b>Reading/clearing error messages</b>	Displays and clears error messages and displays MESSAGE instruction messages.
<b>Buzzer operation</b>	Turns on and off the buzzer that sounds when Programming Console keys are pressed.
<b>Setting a program memory address</b>	Sets the specified program memory address when reading, writing, inserting and deleting programs.
<b>Reading a program memory address</b>	Reads the contents of the Program Memory. Displays the status of the currently displayed bit in PROGRAM and MONITOR modes.
<b>Instruction search</b>	Finds occurrences of the specified instruction in the program.
<b>Bit operand search</b>	Finds occurrences of the specified operand bit in the program.
<b>Inserting and deleting instructions</b>	Inserts or deletes instructions from the program.
<b>Entering or editing programs</b>	Overwrites the contents of the current Program Memory to either input a program for the first time or to change a program that already exists.
<b>Checking the program</b>	Checks for programming errors and displays the program address and error when errors are found.
<b>Bit, digit, word monitor</b>	Monitors the status of up to 16 bits and words, although only 3 can be shown on the display at one time.
<b>Multiple address monitor</b>	Monitors the status of up to 6 bits and words simultaneously.
<b>Differentiation monitor</b>	Monitors the up or down differentiation status of a particular bit.
<b>Binary monitor</b>	Monitors the ON/OFF status of any word's 16 bits.
<b>3-word monitor</b>	Monitors the status of three consecutive words.
<b>Signed decimal monitor</b>	Converts the contents of the specified word from signed hexadecimal (two's complement format) to signed decimal for display.
<b>Unsigned decimal monitor</b>	Converts hexadecimal data in a word to unsigned decimal for display.
<b>3-word data modification</b>	Changes the contents of one or more of the 3 consecutive words displayed in the 3-Word Monitor operation.
<b>Changing timer, counter SV 1</b>	Changes the SV of a timer or counter.
<b>Changing timer, counter SV 2</b>	Makes fine adjustment changes to the SV of the timer or counter.
<b>Hexadecimal, BCD data modification</b>	Changes the BCD or hexadecimal value of a word being monitored.
<b>Binary data modification</b>	Changes the status of a word's bits when the word is being monitored.
<b>Signed decimal data modification</b>	Changes the decimal value of a word being monitored as signed decimal data, within a range of -32,768 to 32,767. The contents of the specified word are converted automatically to signed hexadecimal (two's complement format.)
<b>Unsigned decimal data modification</b>	Changes the decimal value of a word being monitored as unsigned decimal data, within a range of 0 to 65,535. A change into hexadecimal data is made automatically.
<b>Force set/reset</b>	Forces bits ON (force set) or OFF (force reset.)
<b>Clear force set/reset</b>	Restores the status of all bits which have been force set or reset.
<b>Hex-ASCII display change</b>	Converts word data displays back and forth between 4-digit hexadecimal data and ASCII.
<b>Displaying the cycle time</b>	Displays the current average cycle time (scan time.)

### 4-3-2 Clearing Memory

This operation is used to clear all or part of the Program Memory and any data areas that are not read-only, as well as the contents of the Programming Console's memory. This operation is possible in PROGRAM mode only.

RUN	MONITOR	PROGRAM
No	No	OK

Before beginning to program for the first time or when installing a new program, clear all areas.

#### All Clear

The following procedure is used to clear memory completely.

- 1, 2, 3... 1. Bring up the initial display by pressing the CLR key repeatedly.
2. Press the SET, NOT, and then the RESET Key to begin the operation.

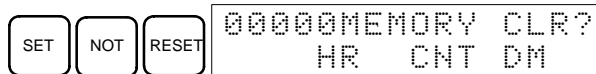

3. Press the MONTR Key to clear memory completely.

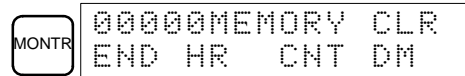

**Caution** The PC Setup (DM 6600 through DM 6655) will be cleared when this operation is performed.

#### Partial Clear

It is possible to retain the data in specified areas or part of the Program Memory. To retain the data in the HR, TC, or DM Areas, press the appropriate key after pressing SET, NOT, and RESET. Any data area that still appears on the display will be cleared when the MONTR Key is pressed.

The HR Key is used to specify both the AR and HR Areas, the CNT Key is used to specify the entire timer/counter area, and the DM Key is used to specify the DM Area.

It is also possible to retain a portion of the Program Memory from the first memory address to a specified address. After designating the data areas to be retained, specify the first Program Memory address to be cleared. For example, input 030 to leave addresses 000 to 029 untouched, but to clear addresses from 030 to the end of Program Memory.

As an example, follow the procedure below to retain the timer/counter area and Program Memory addresses 000 through 122:

- 1, 2, 3... 1. Press the CLR Key to bring up the initial display.
2. Press the SET, NOT, and then the RESET Key to begin the operation.
3. Press the CNT Key to remove the timer/counter area from the data areas shown on the display.

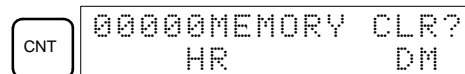

4. Press 123 to specify 123 as the starting program address.

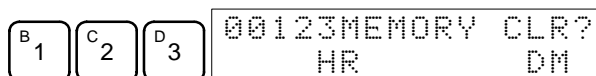

5. Press the MONTR Key to clear the specified regions of memory.

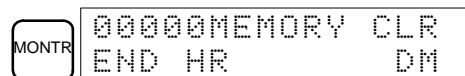

### 4-3-3 Reading/Clearing Error Messages

This operation is used to display and clear error messages. It is possible to display and clear non-fatal errors and MESSAGE instruction messages in any mode, but fatal errors can be cleared in PROGRAM mode only.

RUN	MONITOR	PROGRAM
OK	OK	OK

Before inputting a new program, any error messages recorded in memory should be cleared. It is assumed here that the causes of any of the errors for which error messages appear have already been taken care of. If the buzzer sounds when an attempt is made to clear an error message, eliminate the cause of the error, and then clear the error message. (Refer to *Section 5 Test Runs and Error Processing* for troubleshooting information.)

#### Key Sequence

Follow the procedure below to display and clear messages.

- 1, 2, 3... 1. Press the CLR Key to bring up the initial display.
2. Press the FUN and then the MONTR Key to begin the operation. If there are no messages, the following display will appear:

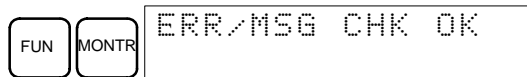

If there are messages, the most serious message will be displayed when the MONTR Key is pressed. Pressing MONTR again will clear the present message and display the next most serious error message. Continue pressing MONTR until all messages have been cleared. These are some examples of error messages:

A memory error:

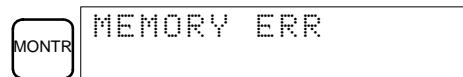

A system error:

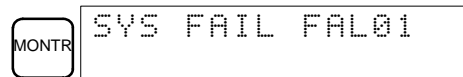

A message:

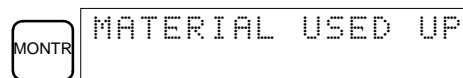

All messages cleared:

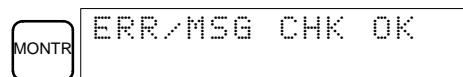

### 4-3-4 Buzzer Operation

This operation is used to turn on and off the buzzer that sounds when Programming Console keys are pressed. This buzzer will also sound whenever an error occurs during PC operation. Buzzer operation for errors is not affected by this setting.

This operation is possible in any mode.

RUN	MONITOR	PROGRAM
OK	OK	OK



**Key Sequence**

Follow the procedure below to turn the key-input buzzer on and off.

- 1, 2, 3... 1. Press the CLR, SHIFT, and then the CLR Key to bring up the mode display. In this case the PC is in PROGRAM mode and the buzzer is on.

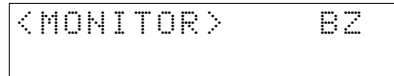

2. Press the SHIFT and then the 1 Key to turn off the buzzer.



3. Press the SHIFT and then the 1 Key again to turn the buzzer back on.

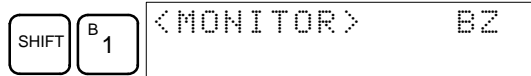

### 4-3-5 Setting and Reading a Program Memory Address

This operation is used to display the specified program memory address and is possible in any mode.

RUN	MONITOR	PROGRAM
OK	OK	OK

When inputting a program for the first time, it is generally written to Program Memory starting from address 000. Because this address appears when the display is cleared, it is not necessary to specify it.

When inputting a program starting from other than 000 or to read or modify a program that already exists in memory, the desired address must be designated.

- 1, 2, 3... 1. Press the CLR Key to bring up the initial display.
2. Input the desired address. It is not necessary to input leading zeroes.

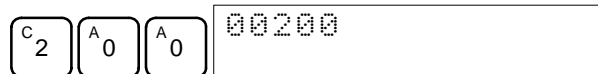

3. Press the Down Arrow Key.

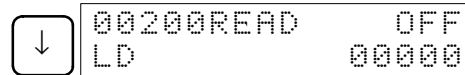

**Note** The ON/OFF status of any displayed bit will be shown if the PC is in RUN or MONITOR mode.

4. Press the Up and Down Arrow Keys to scroll through the program.

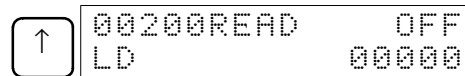
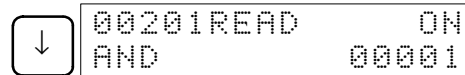

### 4-3-6 Instruction Search

This operation is used to find occurrences of the specified instruction in the program and is possible in any mode.

RUN	MONITOR	PROGRAM
OK	OK	OK

The ON/OFF status of any displayed bit will be shown if the PC is in RUN or MONITOR mode.

- 1, 2, 3... 1. Press the CLR Key to bring up the initial display.

- Input the address from which the search will begin and press the Down Arrow Key. It is not necessary to input leading zeroes.

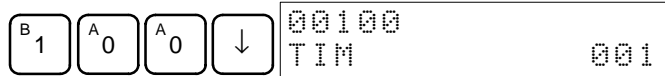

- Input the instruction to be found and press the SRCH Key. In this case, the search is for LD instructions.

In this case, the next LD instruction is at address 200, as shown below.

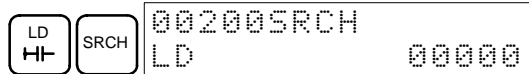

- Press the Down Arrow Key to display the instruction's operands or press the SRCH Key to search for the next occurrence of the instruction.
- The search will continue until an END instruction or the end of Program Memory is reached. In this case, an END instruction was reached at address 397.

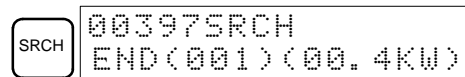

### 4-3-7 Bit Operand Search

This operation is used to find occurrences of the specified operand bit in the program and is possible in any mode.

RUN	MONITOR	PROGRAM
OK	OK	OK

The ON/OFF status of any displayed bit will be shown if the PC is in RUN or MONITOR mode.

- 1, 2, 3... 1. Press the CLR Key to bring up the initial display.
2. Input the operand address. It is not necessary to input leading zeroes.



3. Press the SRCH Key to begin the search.

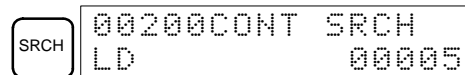

4. Press the SRCH Key to search for the next occurrence of the operand bit.
5. The search will continue until an END instruction or the end of Program Memory is reached. In this case, an END instruction was reached.

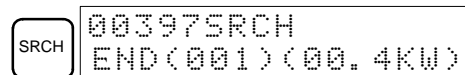

### 4-3-8 Inserting and Deleting Instructions

This operation is used to insert or delete instructions from the program. It is possible in PROGRAM mode only.

RUN	MONITOR	PROGRAM
No	No	OK

To demonstrate this operation, an IR 00105 NO condition will be inserted at program address 00206 and an IR 00103 NO condition deleted from address 00205, as shown in the following diagram.

Original Program

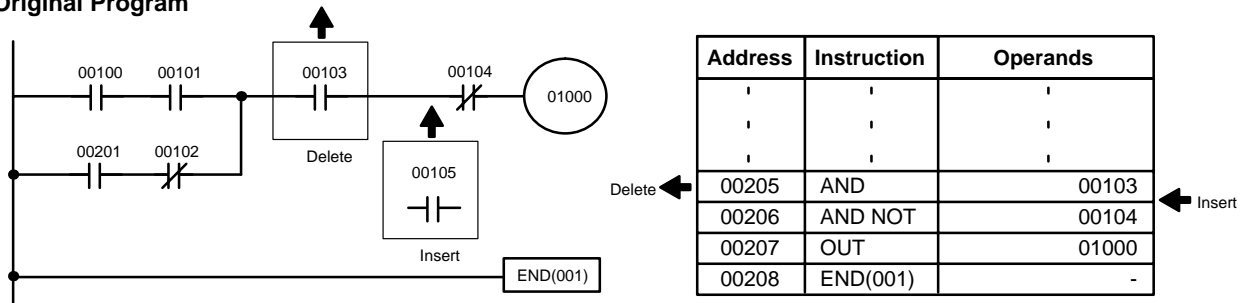

**Insertion**

Follow the procedure below to insert the IR 00105 NO condition at address 00206.

- 1, 2, 3...**
1. Press the CLR Key to bring up the initial display.
  2. Input the address where the NO condition will be inserted and press the Down Arrow Key. It is not necessary to input leading zeroes.

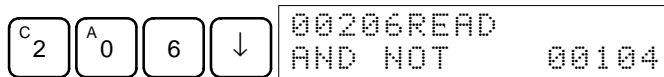

3. Input the new instruction and press the INS Key.



4. Press the Down Arrow Key to insert the new instruction.

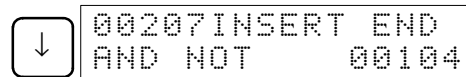

**Note** For instructions that require more operands (such as set values), input the operands and then press the WRITE Key.

**Deletion**

Follow the procedure below to delete the IR 00103 NO condition at address 00205.

- 1, 2, 3...**
1. Press the CLR Key to bring up the initial display.
  2. Input the address where the NO condition will be deleted and press the Down Arrow Key. It is not necessary to input leading zeroes.

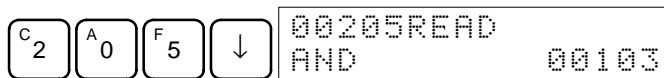

3. Press the DEL Key.

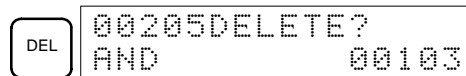

4. Press the Up Arrow Key to delete the specified instruction.

If the instruction has more operands, the operands will be deleted automatically with the instruction.

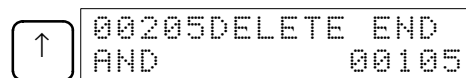

After completing the insertion and deletion procedures, use the Up and Down Arrow Keys to scroll through the program and verify that it has been changed correctly, as shown in the following diagram.

Corrected Program

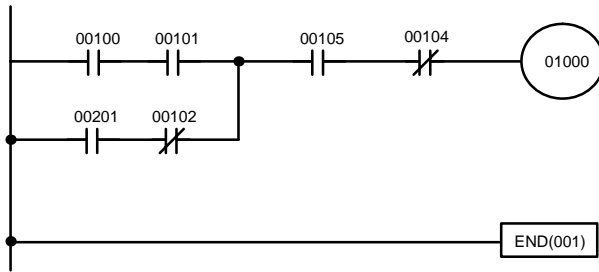

Address	Instruction	Operands
00205	AND	00105
00206	AND NOT	00104
00207	OUT	01000
00208	END(001)	-

### 4-3-9 Entering or Editing Programs

This operation is used enter or edit programs. It is possible in PROGRAM mode only.

RUN	MONITOR	PROGRAM
No	No	OK

The same procedure is used to either input a program for the first time or to change a program that already exists. In either case, the current contents of Program Memory is overwritten.

The program shown in the following diagram will be entered to demonstrate this operation.

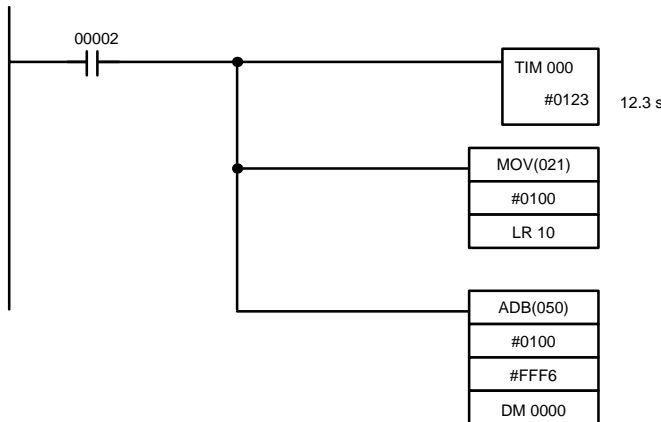

Address	Instruction	Operands
00200	LD	IR 00002
00201	TIM	000
		#0123
00202	MOV(021)	#0100
		LR 10
00203	ADB(050)	#0100
		#FFF6
		DM 0000

- 1, 2, 3... 1. Press the CLR Key to bring up the initial display.
2. Specify the address where the program will begin.
3. Input the address where the program will begin and press the Down Arrow Key. It is not necessary to input leading zeroes.

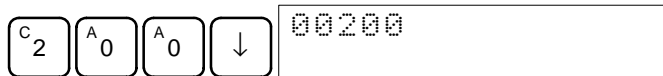

4. Input the first instruction and operand.

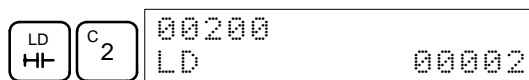

5. Press the WRITE Key to write the instruction to Program Memory. The next program address will be displayed.

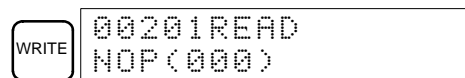

If a mistake was made inputting the instruction, press the Up Arrow Key to return to the previous program address and input the instruction again. The mistaken instruction will be overwritten

- Input the second instruction and operand. (In this case it isn't necessary to enter the timer number, because it's 000.) Press the WRITE Key to write the instruction to Program Memory.



- Input the second operand (123 to specify 12.3 seconds) and press the WRITE Key. The next program address will be displayed.

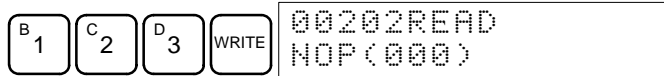

If a mistake was made inputting the operand, press the Up Arrow Key to return to display the mistaken operand, press the CONT/# Key and 123 again. The mistaken operand will be overwritten.

**Note** Counters are input in the same basic way as timers except the CNT Key is pressed instead of the TIM Key.

- Input the third instruction and its operands. First input the instruction by pressing the FUN Key and then the function code (21 in this case).

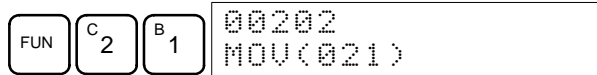

**Note** To input a differentiated instruction, press the NOT Key after entering the function code. The "@" symbol will be displayed next to differentiated instructions. Press the NOT Key again to change back the instruction back to a non-differentiated instruction. The "@" symbol will disappear. To change an instruction after it has been entered, simply scroll through the program until the desired instruction is displayed and press the NOT Key. The "@" symbol should be displayed next to the instruction.

- Press the WRITE Key to write the instruction to Program Memory. The input display for the first operand will be displayed.

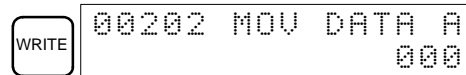

**• Writing Hexadecimal, BCD Constant**

- Input the first operand.

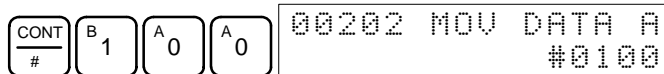

Press the WRITE Key to write the instruction to Program Memory. The input display for the second operand will appear.

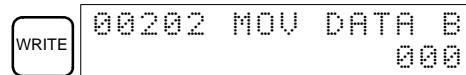

**• Writing a Word Address**

- Input the second operand.

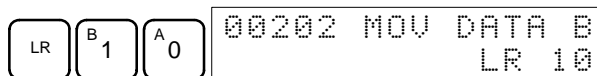

Press the WRITE Key to write the instruction to Program Memory. The next program address will be displayed.

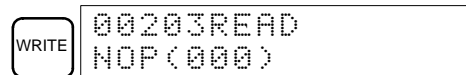

**Note** When an instruction operand is input, the bit or word designation can be omitted.

12. Input the next instruction.



Press the WRITE Key to write the instruction to Program Memory.

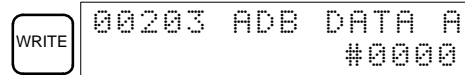

**• Writing an Unsigned Decimal Number**

13. The first operand is input as an unsigned integer.

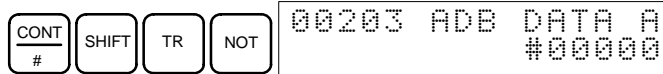

Input the value of the operand from 0 to 65535.

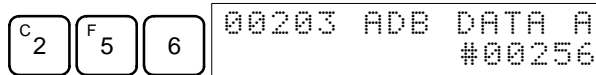

**Note** If an erroneous input is made, press the CLR Key to restore the status prior to the input. Then enter the correct input.

14. Restore the hexadecimal display.

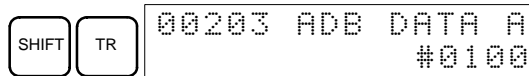

**Note** If an input is made outside of the permissible range, a buzzer will sound and the hexadecimal display will not be displayed.

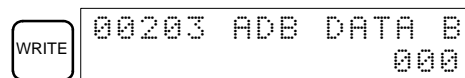

15. The second operand is input as a signed integer.

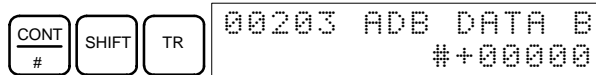

Input the value of the operand from -32,768 to 32,767. Use the SET Key to input a positive number, and use the RESET Key to input a negative number.

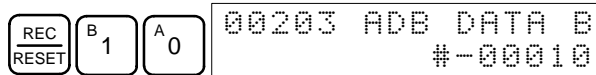

**Note** If an erroneous input is made, press the CLR Key to restore the status prior to the input. Then enter the correct input.

16. Restore the hexadecimal display.

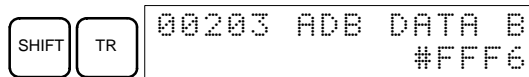

**Note** If an input is made outside of the permissible range, a buzzer will sound and the hexadecimal display will not be displayed.

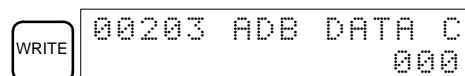

17. Input the final operand and then press the WRITE Key.

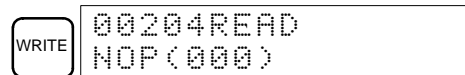
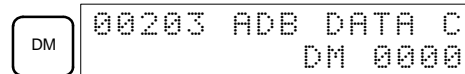

### 4-3-10 Checking the Program

This operation checks for programming errors and displays the program address and error when errors are found. It is possible in PROGRAM mode only.

RUN	MONITOR	PROGRAM
No	No	OK

- 1, 2, 3...
1. Press the CLR Key to bring up the initial display.
  2. Press the SRCH Key. An input prompt will appear requesting the desired check level.

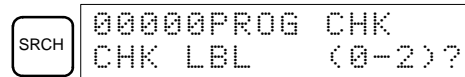

3. Input the desired check level (0, 1, or 2). The program check will begin when the check level is input, and the first error found will be displayed.

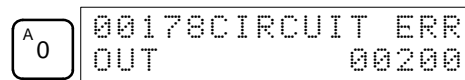

**Note** Refer to 5-5 Programming Errors for details on check levels.

4. Press the SRCH Key to continue the search. The next error will be displayed. Continue pressing the SRCH Key to continue the search. The search will continue until an END instruction or the end of Program Memory is reached. A display like this will appear if the end of Program Memory is reached:

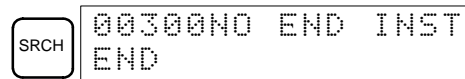

A display like this will appear if an END instruction is reached:

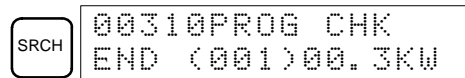

If errors are displayed, edit the program to correct the errors and check the program again. Continue checking the program until all errors have been corrected.

### 4-3-11 Bit, Digit, Word Monitor

This operation is used to monitor the status of up to 16 bits and words, although only 3 can be shown on the display at any one time. Operation is possible in any mode.

RUN	MONITOR	PROGRAM
OK	OK	OK

**Program Read then Monitor** When a program address is being displayed, the status of the bit or word in that address can be monitored by pressing the MONTR Key.

- 1, 2, 3...
1. Press the CLR Key to bring up the initial display.
  2. Input the desired program address and press the Down Arrow Key.

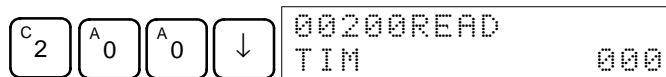

3. Press the MONTR Key to begin monitoring.



If the status of a bit is being monitored, that bit's status can be changed using the Force Set/Reset operation. Refer to page 77 for details.

If the status of a word is being monitored, that word's value can be changed using the Hexadecimal/BCD Data Modification operation. Refer to page 74 for details.

4. Press the CLR Key to end monitoring.

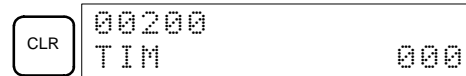

**Bit Monitor**

Follow the procedure below to monitor the status of a particular bit.

- 1, 2, 3... 1. Press the CLR Key to bring up the initial display.
2. Input the bit address of the desired bit and press the MONTR Key.

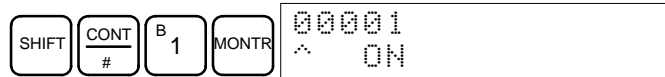

The Up or Down Arrow Key can be pressed to display the status of the previous or next bit.

The displayed bit's status can be changed using the Force Set/Reset operation. Refer to page 77 for details.

3. Press the CLR Key to end monitoring.

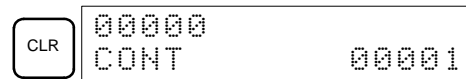

**Word Monitor**

Follow the procedure below to monitor the status of a particular word.

- 1, 2, 3... 1. Press the CLR Key to bring up the initial display.
2. Input the word address of the desired word.

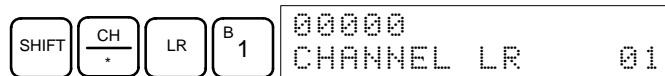

3. Press the MONTR Key to begin monitoring.



The Up or Down Arrow Key can be pressed to display the status of the previous or next word.

The displayed word's status can be changed using the Hexadecimal/BCD Data Modification operation. Refer to page 74 for details.

4. Press the CLR Key to end monitoring.

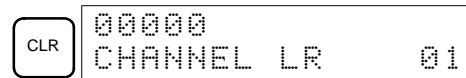

**Multiple Address Monitoring**

The status of up to six bits and words can be monitored simultaneously, although only three can be shown on the display at any one time.

- 1, 2, 3... 1. Press the CLR Key to bring up the initial display.
2. Input the address of the first bit or word and press the MONTR Key.

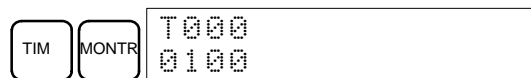

3. Repeat step 2 up to 6 times to display the next addresses to be monitored.

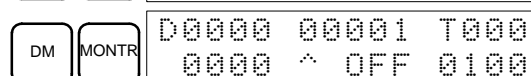
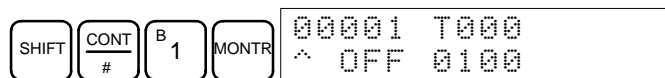

If 4 or more bits and words are being monitored, the bits and words that do not appear on the display can be displayed by pressing the MONTR Key. If the MONTR Key is pressed alone, the display will shift to the right.



If more than six bits and words are input, monitoring of the bit or word input first will be canceled.

4. Press the CLR Key to stop monitoring the leftmost bit or word and clear it from the display.

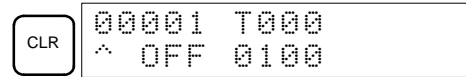

5. Press the SHIFT+CLR Keys to end monitoring altogether.



**Note** Press the SHIFT + CLR Keys to return to the display with the multiple address monitoring state unchanged. Press the SHIFT + MONTR Keys to display the retained multiple address monitoring state. The monitoring states can be retained for 6 bits and words.

### 4-3-12 Differentiation Monitor

This operation is used to monitor the up or down differentiation status of a particular bit. When detected, the up or down differentiation will be displayed and the buzzer will sound. It is possible in any mode.

RUN	MONITOR	PROGRAM
OK	OK	OK

- 1, 2, 3... 1. Monitor the status of the desired bit according to the procedure described in 4-3-11 Bit, Digit, Word Monitor. If 2 or more bits are being monitored, the desired bit should be leftmost on the display.

In this case the differentiation status of LR 00 will be monitored.

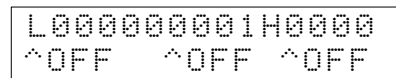

2. To specify up-differentiation monitoring, press the SHIFT and then the Up Arrow Key. The symbols "U@" will appear.

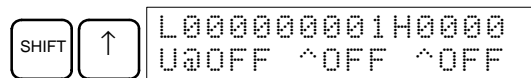

To specify down-differentiation monitoring, press the SHIFT and then the Down Arrow Key. The symbols "D@" will appear.

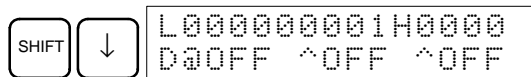

3. The buzzer will sound when the specified bit goes from off to on (for up-differentiation) or from on to off (for down-differentiation).

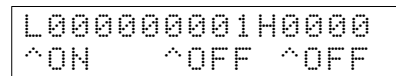

4. Press the CLR Key to end differentiation monitoring and return to the normal monitoring display.

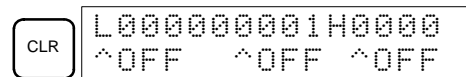

### 4-3-13 Binary Monitor

This operation is used to monitor the ON/OFF status of any word's 16 bits. It is possible in any mode.

RUN	MONITOR	PROGRAM
OK	OK	OK

- 1, 2, 3... 1. Monitor the status of the desired word according to the procedure described in 4-3-11 *Bit, Digit, Word Monitor*. The desired word should be leftmost on the display if 2 or more words are being monitored.



(Word monitor)

2. Press the SHIFT and then the MONTR Key to begin binary monitoring. The ON/OFF status of the selected word's 16 bits will be shown along the bottom of the display. A 1 indicates a bit is on, and a 0 indicates it is off.

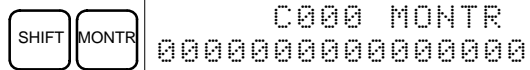

The status of force-set bits is indicated by "S," and the status of a force-reset bits is indicated by "R," as shown below.

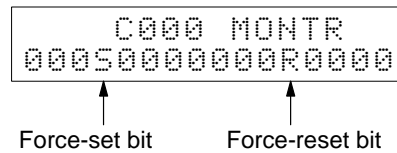

- Note** a) The status of displayed bits can be changed at this point. Refer to 4-3-20 *Binary Data Modification* for details.  
 b) The Up or Down Arrow Key can be pressed to display the status of the previous or next word's bits.

3. Press the CLR Key to end binary monitoring and return to the normal monitoring display.



### 4-3-14 3-Word Monitor

This operation is used to monitor the status of three consecutive words. It is possible in any mode.

RUN	MONITOR	PROGRAM
OK	OK	OK

- 1, 2, 3... 1. Monitor the status of the first of the three words according to the procedure described in 4-3-11 *Bit, Digit, Word Monitor*. If 2 or more words are being monitored, the desired first word should be leftmost on the display.



(Word monitor)

2. Press the EXT Key to begin 3-word monitoring. The status of the selected word and the next two words will be displayed, as shown below. In this case, DM 0000 was selected.

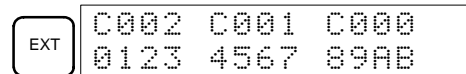

The Up and Down Arrow Keys can be used to shift one address up or down. The status of the displayed words can be changed at this point. Refer to 4-3-17 *3-word Data Modification*.

3. Press the CLR Key to end 3-word monitoring and return to the normal monitoring display. The rightmost word on the 3-word monitor display will be monitored.



### 4-3-15 Signed Decimal Monitor

This operation converts the contents of the specified word from signed hexadecimal (two's complement format) to signed decimal for display. The operation can be executed while using I/O monitoring, multiple address monitoring or 3-word monitoring.

RUN	MONITOR	PROGRAM
OK	OK	OK

- 1, 2, 3... 1. Monitor the word that is to be used for decimal monitor with sign. During multiple address monitoring, the leftmost word will be converted.

(Multiple address monitor) 

c000	cL00	20000
FFF0	0000	^OFF

2. Press the SHIFT+TR Keys to display the leftmost word as signed decimal.

SHIFT	TR
-------	----

c000
-00016

At this point, the contents of the displayed word can be changed with a signed-decimal input. Refer to 4-3-21 Signed Decimal Data Modification.

3. Press the CLR Key or the SHIFT+TR Keys to end the unsigned decimal display and return to normal monitoring.

CLR
-----

c000	cL00	20000
FFF0	0000	^OFF

### 4-3-16 Unsigned Decimal Monitor

This operation is used to convert hexadecimal data in a word to unsigned decimal for display. The operation can be executed while using I/O monitoring, multiple address monitoring or 3-word monitoring.

RUN	MONITOR	PROGRAM
OK	OK	OK

- 1, 2, 3... 1. Monitor the word that is to be used for decimal monitor without sign. During multiple address monitoring, the leftmost word will be converted.

Multiple address monitoring 

c000	cL00	20000
FFF0	0000	^OFF

2. Press the SHIFT+TR+NOT Keys to display the leftmost word as unsigned decimal.

SHIFT	TR	NOT
-------	----	-----

c000
65520

At this point, the contents of the displayed word can be changed with an unsigned-decimal input. Refer to 4-3-22 Unsigned Decimal Data Modification.

3. Press the CLR Key or the SHIFT+TR Keys to end the unsigned decimal display and return to normal monitoring.

CLR
-----

c000	cL00	20000
FFF0	0000	^OFF

### 4-3-17 3-Word Data Modification

This operation is used to change the contents of one or more of the 3 consecutive words displayed in the 3-Word Monitor operation. It is possible in MONITOR or PROGRAM mode only.

RUN	MONITOR	PROGRAM
No	OK	OK

- 1, 2, 3... 1. Monitor the status of the desired words according to the procedure described 4-3-14 3-Word Monitor.

```
D00002D00001D00000
0123 4567 89AB
```

(3-word monitor)

2. Press the CHG Key to begin 3-word data modification. The cursor will appear next to the contents of the leftmost word.

```
CHG D00002 3CH CHG?
#0123 4567 89AB
```

3. Input the new value for the leftmost word on the display and press the CHG Key if more changes will be made.  
(Input the new value and press the WRITE Key to write the changes in memory if no more changes will be made.)

```
B 1 CHG D00002 3CH CHG?
0001 #4567 89AB
```

4. Input the new value for the middle word on the display and press the CHG Key if the rightmost word will be changed. Input the new value and press the WRITE Key to write the changes in memory if the rightmost word will not be changed. (In this case, it will not.)

```
C 2 D 3 E 4 WRITE D00002D00001D00000
0001 0234 89AB
```

**Note** If the CLR Key is pressed before the WRITE Key, the operation will be cancelled and the 3-word monitor display will return without any changes in data memory.

### 4-3-18 Changing Timer, Counter SV

There are two operations that can be used to change the SV of a timer or counter. They are possible in MONITOR or PROGRAM mode only. In MONITOR mode, the SV can be changed while the program is being executed.

RUN	MONITOR	PROGRAM
No	OK	OK

The timer or counter SV can be changed either by inputting a new value or by incrementing or decrementing the current SV.

**Caution** Check that there is no effect on equipment before changing the set values.

#### Inputting a New SV Constant

This operation can be used to input a new SV constant, as well as to change an SV from a constant to a word address designation and vice versa. The following examples show how to input a new SV constant and how to change the SV from a constant to an address.

- 1, 2, 3... 1. Press the CLR Key to bring up the initial display.  
2. Display the desired timer or counter.

```
TIM B 1 SRCH 00201SRCH
TIM 001
```

3. Press the Down Arrow Key and then the CHG Key.

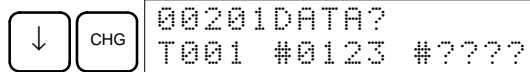

4. At this point a new SV constant can be input or the SV constant can be changed to a word address designation

a) To input a new SV constant, input the constant and press the WRITE Key.

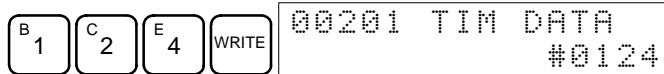

b) To change to a word address designation, input the word address and press the WRITE Key.

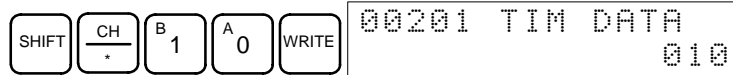

**Incrementing and Decrementing a Constant**

This operation can be used to increment and decrement an SV constant. It is possible only when the SV has been entered as a constant.

1, 2, 3...

1. Press the CLR Key to bring up the initial display.
2. Display the desired timer or counter.

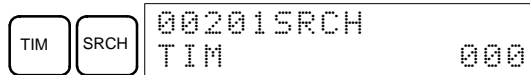

3. Press the Down Arrow, CHG, and then the EXT Key.

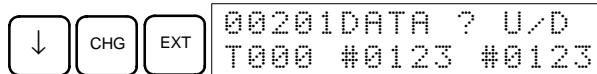

The constant on the left is the old SV and the constant on the right will become the new SV constant in step 5.

4. Press the Up and Down Arrow Keys to increment and decrement the constant on the right. (In this case the SV is incremented once.)

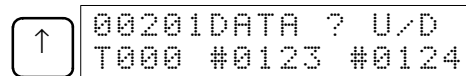

5. Press the CLR Key twice to change the timer's SV to the new value.

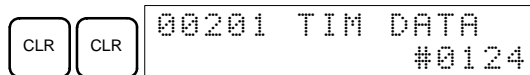

**4-3-19 Hexadecimal, BCD Data Modification**

This operation is used to change the BCD or hexadecimal value of a word being monitored using the procedure described in 4-3-11 *Bit, Digit, Word Monitor*. It is possible in MONITOR or PROGRAM mode only.

RUN	MONITOR	PROGRAM
No	OK	OK

Words SR 253 to SR 255 cannot be changed.

**Caution** Check that there is no effect on equipment before changing the present values.

1, 2, 3...

1. Monitor the status of the desired word according to the procedure described in 4-3-11 *Bit, Digit, Word Monitor*. If two or more words are being monitored, the desired word should be leftmost on the display.

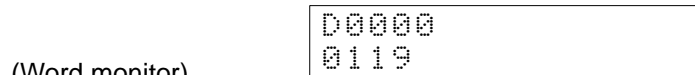

(Word monitor)

2. Press the CHG Key to begin hexadecimal, BCD data modification.

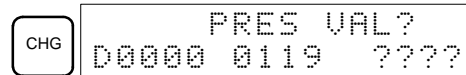

3. Input the new PV and press the WRITE Key to change the PV.  
The operation will end and the normal monitoring display will return when the WRITE Key is pressed.

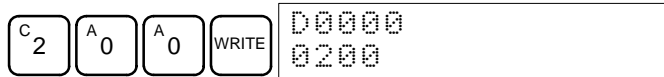

### 4-3-20 Binary Data Modification

This operation is used to change the status of a word's bits when the word is monitored using the procedure described in 4-3-13 *Binary Monitor*. It is possible in MONITOR or PROGRAM mode only.

RUN	MONITOR	PROGRAM
No	OK	OK

Bits SR 25300 to SR 25507 and timer/counter flags cannot be changed.

**Caution** Check that there is no effect on equipment before changing the present values.

- 1, 2, 3... 1. Monitor the status of the desired word according to the procedure described 4-3-13 *Binary Monitor*.

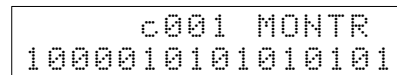

(Binary monitor)

2. Press the CHG Key to begin binary data modification.

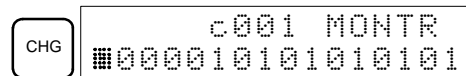

A flashing cursor will appear over bit 15. The cursor indicates which bit can be changed.

3. Three sets of keys are used to move the cursor and change bit status:
  - a) Use the Up and Down Arrow Keys to move the cursor to the left and right.

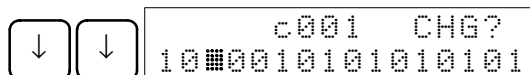

- b) Use the 1 and 0 keys to change a bit's status to on or off. The cursor will move one bit to the right after one of these keys is pressed.

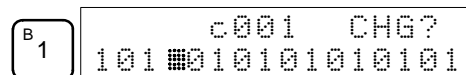

- c) Use the SHIFT+SET and SHIFT+RESET Keys to force-set or force-reset a bit's status. The cursor will move one bit to the right after one of these keys is pressed. The NOT Key will clear force-set or force-reset status.

**Note** Bits in the DM Area cannot be force-set or force-reset.

4. Press the WRITE Key to write the changes in memory and return to the binary monitor.

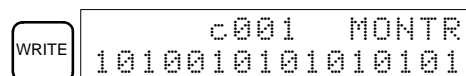

### 4-3-21 Signed Decimal Data Modification

This operation is used to change the decimal value of a word being monitored as signed decimal data, within a range of -32,768 to 32,767. The con-

tents of the specified word are converted automatically to signed hexadecimal (two's complement format).

Words SR 253 to SR 255 cannot be changed.

RUN	MONITOR	PROGRAM
No	OK	OK

**Caution** Check that there is no effect on equipment before changing the current values.

- 1, 2, 3... 1. Monitor (signed decimal) the status of the word for which the present value is to be changed.

```
c000
-00016
```

(Signed decimal monitor)

2. Press the CHG Key to begin decimal data modification.

```
CHG      PRES VAL?
c000 -00016
```

3. Input the new PV and press the WRITE Key to change the PV. The operation will end and the signed-decimal monitoring display will return when the WRITE Key is pressed.

The PV can be set within a range of -32,768 and 32,767. Use the SET Key to input a positive number, and use the RESET Key to input a negative number.

```
REC  D  C  7  6  8  WRITE
RESET 3 2          c000
                    -32768
```

Press the CLR Key or the SHIFT and TR Keys to return to the normal monitoring display.

If an erroneous input has been made, press the CLR Key to restore the status prior to the input. Then enter the correct input.

### 4-3-22 Unsigned Decimal Data Modification

This operation is used to change the decimal value of a word being monitored as unsigned decimal data, within a range of 0 to 65,535. A change into hexadecimal data is made automatically.

Words SR 253 to SR 255 cannot be changed.

RUN	MONITOR	PROGRAM
No	OK	OK

**Caution** Check that there is no effect on equipment before changing the current values.

- 1, 2, 3... 1. Monitor (unsigned decimal) the status of the word for which the present value is to be changed.

```
c000
65520
```

(Unsigned decimal monitor)

2. Press the CHG Key to begin decimal data modification.

```
CHG      PRES VAL?
c000 65520
```

3. Input the new PV and press the WRITE Key to change the PV. The operation will end and the decimal-without-sign monitoring display will return when the WRITE Key is pressed.

The PV can be set within a range of 0 to 65,535.

```
D  C  7  6  8  WRITE
3  2          c000
                    32768
```

Press the CLR Key or the SHIFT and TR Keys to return to the normal monitoring display.

If an erroneous input has been made, press the CLR Key to restore the status prior to the input. Then enter the correct input.

### 4-3-23 Force Set, Reset

This operation is used to force bits ON (force set) or OFF (force reset) and is useful when debugging the program or checking output wiring. It is possible in MONITOR or PROGRAM mode only.

RUN	MONITOR	PROGRAM
No	OK	OK

**Caution** Check that there is no effect on equipment before using force set/reset.

- 1, 2, 3... 1. Monitor the status of the desired bit according to the procedure described in 4-3-11 *Bit, Digit, Word Monitor*. If two or more words are being monitored, the desired bit should be leftmost on the display.

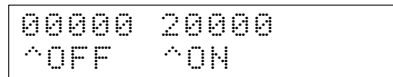

(Multiple address monitor)

2. Press the SET Key to force the bit ON or press the RESET Key to force the bit OFF.

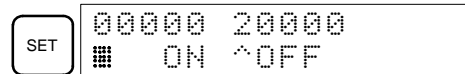

The cursor in the lower left corner of the display indicates that the force set/reset is in progress. Bit status will remain ON or OFF only as long as the key is held down; the original status will return one cycle after the key is released.

3. Press the SHIFT+SET or SHIFT+RESET Keys to maintain the status of the bit after the key is released. In this case, the force-set status is indicated by an "S" and the force-reset status is indicated by an "R."

To return the bit to its original status, press the NOT Key or perform the Clear Force Set/Reset operation. Refer to 4-3-24 *Clear Force Set/Reset* for details.

Forced status will also be cleared when the PC's operating mode is changed (unless SR 25211 is ON, in which case forced status will not be cleared when changing from PROGRAM to MONITOR mode) or when operation stops as the result of a fatal error or power interruption.

### 4-3-24 Clear Force Set/Reset

This operation is used to restore the status of all bits which have been force set or reset. It is possible in MONITOR or PROGRAM mode only.

RUN	MONITOR	PROGRAM
No	OK	OK

**Caution** Check that there is no effect on equipment before using clear force set/reset.

- 1, 2, 3... 1. Press the CLR Key to bring up the initial display.  
2. Press the SET and then the RESET Key. A confirmation message will appear.

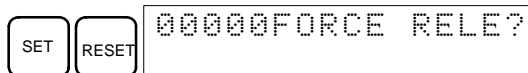



**Note** If you mistakenly press the wrong key, press CLR and start again from the beginning.

3. Press the NOT Key to clear the force-set/reset status of bits in all data areas.



### 4-3-25 Hex-ASCII Display Change

This operation is used to convert word data displays back and forth between 4-digit hexadecimal data and ASCII. It is possible in any mode.

RUN	MONITOR	PROGRAM
OK	OK	OK

- 1, 2, 3... 1. Monitor the status of the desired word(s) according to the procedure described in 4-3-11 *Bit, Digit, Word Monitor*.

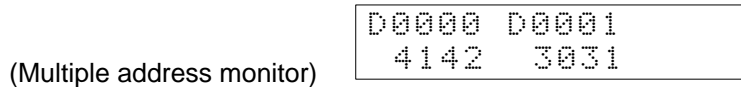

(Multiple address monitor)

2. Press the TR Key to switch to ASCII display. The display will toggle between hexadecimal and ASCII displays each time the TR Key is pressed.

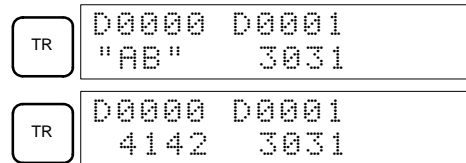

### 4-3-26 Displaying the Cycle Time

This operation is used to display the current average cycle time (scan time). It is possible only in RUN or MONITOR mode while the program is being executed.

RUN	MONITOR	PROGRAM
OK	OK	No

- 1, 2, 3... 1. Press the CLR Key to bring up the initial display.
2. Press the MONTR Key to display the cycle time.

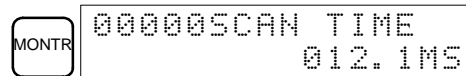

There might be differences in displayed values when the MONTR Key is pressed repeatedly. These differences are caused by changing execution conditions.

## 4-4 Programming Example

This section demonstrates all of the steps needed to write a program with the Programming Console.

### 4-4-1 Preparatory Operations

When writing a program to the CPM1 for the first time, use the following procedure up to step 3 (clearing memory).

- 1, 2, 3... 1. Set the Programming Console's mode switch to PROGRAM mode and turn on the CPM1's power supply. The password input display will appear on the Programming Console.



```
<PROGRAM>
PASSWORD!
```

2. Enter the password by pressing the CLR and then the MONTR Key.

CLR MONTR <PROGRAM>

At this point, the SHIFT and then the 1 key can be pressed to turn on and off the Programming Console's buzzer. Refer to page 61.

3. Clear the CPM1's memory by pressing the CLR, SET, NOT, RESET, and then the MONTR Key. Press the CLR Key several times if memory errors are displayed.

CLR 00000

SET NOT RESET 00000MEMORY CLR?  
HR CNT DM

MONTR 00000MEMORY CLR  
END HR CNT DM

4. Display and clear error messages by pressing the CLR, FUN, and then the MONTR Key. Continue pressing the MONTR Key until all error messages have been cleared.

CLR 00000

FUN 00000  
FUN(0???)

MONTR ERR/MSG CHK OK

5. Press the CLR Key to bring up the initial programming display (program address 00000). The new program can be written at this point.

CLR 00000

**Caution** Be sure that the mode selector is set to PROGRAM before entering the password. Check the system thoroughly before executing the CPM1 program to prevent any accidents that might occur when the program is first started.

### 4-4-2 Example Program

The following ladder program will be used to demonstrate how to write a program with the Programming Console. This program makes output IR 01000 flicker ON/OFF (one second ON, one second OFF) ten times after input IR 00000 is turned ON.

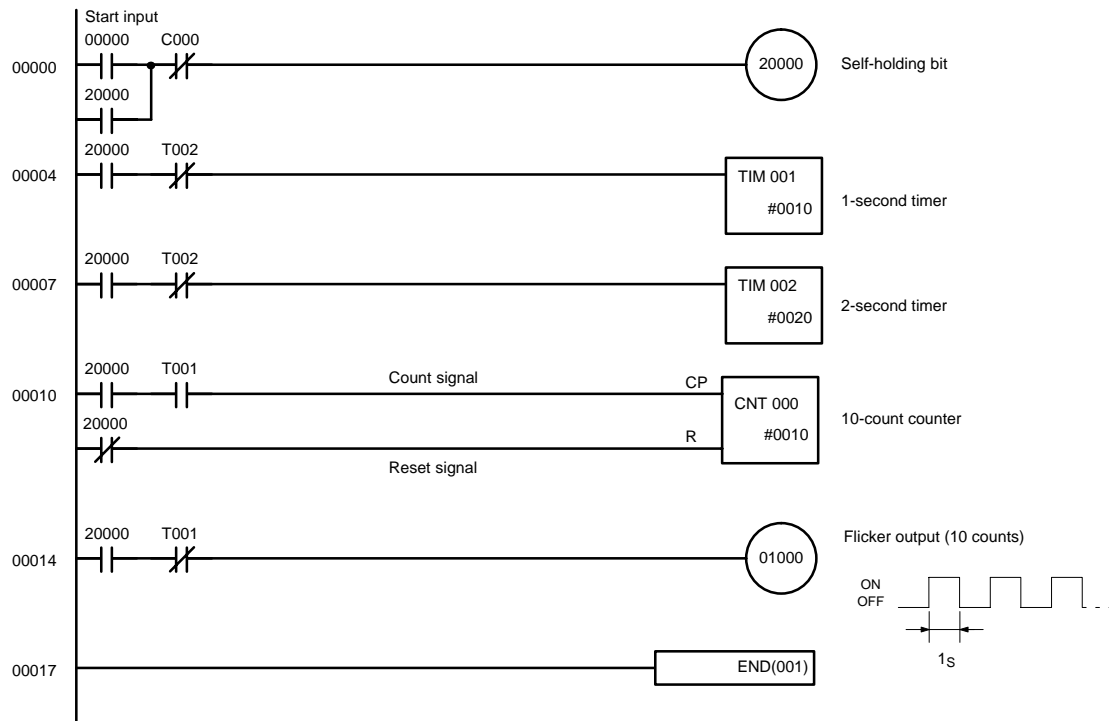

The mnemonic list for the example program is shown in the following table. The steps required to enter this program from a Programming Console are described in 4-4-3 Programming Procedure.

Address	Instruction	Data	Programming example procedures in 4-4-3 Programming Procedures
00000	LR	00000	(1) Self-holding bit
00001	OR	20000	
00002	AND NOT	C 000	
00003	OUT	20000	
00004	LD	20000	(2) 1-second timer
00005	AND NOT	T 002	
00006	TIM	001	
		# 0010	
00007	LD	20000	(3) 2-second timer
00008	AND NOT	T 002	
00009	TIM	002	
		# 0020	
00010	LD	20000	(4) 10-count counter
00011	AND	T 001	
00012	LD NOT	20000	
00013	CNT	000	
		# 0010	
00014	LD	20000	(5) Flicker output (10 counts)
00015	AND NOT	T 001	
00016	OUT	01000	
00017	END (001)	---	(6) END(001) instruction

### 4-4-3 Programming Procedures

The example program will be written to the CPM1 according to the mnemonic list in 4-4-2 Example Program. The procedure is performed beginning with the initial display. (Clear the memory before entering a new program.)

#### (1) Inputting the Self-holding Bit

- 1, 2, 3... 1. Input the normally open condition IR 00000.  
(It isn't necessary to input leading zeroes.)

LD	LD	00000
WRITE	00001	READ
		NOP(000)

2. Input the OR condition IR 20000.

OR	C 2	A 0	A 0	A 0	A 0	00001	OR	20000
WRITE	00002	READ						
		NOP(000)						

3. Input the normally closed AND condition C000.  
(It isn't necessary to input leading zeroes.)

AND	NOT	CNT	00002	AND NOT CNT	000
WRITE	00003	READ			
		NOP(000)			

4. Input the OUT instruction IR 20000.

OUT	C 2	A 0	A 0	A 0	A 0	00003	OUT	20000
WRITE	00004	READ						
		NOP(000)						

#### (2) Inputting the One-second Timer

- 1, 2, 3... 1. Input the normally open condition IR 20000.

LD	C 2	A 0	A 0	A 0	A 0	00004	LD	20000
WRITE	00005	READ						
		NOP(000)						

2. Input the normally closed AND condition T002.  
(It isn't necessary to input leading zeroes.)

AND	NOT	TIM	C 2	00005	AND NOT TIM	002
WRITE	00006	READ				
		NOP(000)				

3. Input the 1-second timer T001.

TIM	B 1	00006	TIM	001
WRITE	00006	TIM DATA		
		#0000		

4. Input the SV for T001 (#0010 = 1.0 s).

B 1	A 0	00006 TIM DATA #0010
WRITE	00007READ NOP(000)	

**(3) Inputting the Two-second Timer**

The following key operations are used to input the 2-second timer.

1, 2, 3...

1. Input the normally open condition IR 20000.

LD	C 2	A 0	A 0	A 0	A 0	00007 LD 20000
WRITE	00008READ NOP(000)					

2. Input the normally closed AND condition T002.  
(It isn't necessary to input leading zeroes.)

AND	NOT	TIM	C 2	00008 AND NOT TIM 002
WRITE	00009READ NOP(000)			

3. Input the 2-second timer T002.

TIM	C 2	00009 TIM 002
WRITE	00009 TIM DATA #0000	

4. Input the SV for T002 (#0020 = 1.0 s).

C 2	A 0	00009 TIM DATA #0020
WRITE	00010READ NOP(000)	

**(4) Inputting the 10-count Counter**

The following key operations are used to input the 10-count counter.

1, 2, 3...

1. Input the normally open condition IR 20000.

LD	C 2	A 0	A 0	A 0	A 0	00010 LD 20000
WRITE	00011READ NOP(000)					

2. Input the normally open AND condition T001.  
(It isn't necessary to input leading zeroes.)

AND	TIM	B 1	00011 AND TIM 001
WRITE	00012READ NOP(000)		

3. Input the normally closed condition IR 20000.

LD	NOT	C 2	A 0	A 0	A 0	A 0	00012 LD NOT 20000
WRITE	00013READ NOP(000)						

4. Input the counter 000.

CNT	A 0	00013 CNT                   000
WRITE		00013 CNT DATA #0000

5. Input the SV for 000 (#0010 = 10 counts).

B 1	A 0	00013 CNT DATA #0010
WRITE		00014READ NOP(000)

**(5) Inputting the Flicker Output**

1, 2, 3... 1. Input the normally open condition IR 20000.

LD	C 2	A 0	A 0	A 0	A 0	00014 LD                   20000
WRITE						00015READ NOP(000)

2. Input the normally closed AND condition T001.  
(It isn't necessary to input leading zeroes.)

AND	NOT	TIM	B 1	00015 AND NOT TIM 001
WRITE				00016READ NOP(000)

3. Input the OUT instruction IR 01000.  
(It isn't necessary to input leading zeroes.)

OUT	B 1	A 0	A 0	A 0	00016 OUT                   01000
WRITE					00017READ NOP(000)

**(6) Inputting the END(001) Instruction**

Input END (001)

FUN	00017 FUN(0??)	
A 0	B 1	00017 FUN(001)
WRITE		00018READ NOP(000)

**4-4-4 Checking the Program**

Check the program syntax in PROGRAM mode to make sure that the program has been input correctly.

1, 2, 3... 1. Press the CLR Key to bring up the initial display.

000000
--------

2. Press the SRCH Key. An input prompt will appear requesting the desired check level.

SRCH	00000PROG CHK CHK LBL (0-2)?
------	---------------------------------

- Input the desired check level (0, 1, or 2). The program check will begin when the check level is input, and the first error found will be displayed.



**Note** Refer to 5-5 Programming Errors for details on check levels.

- Press the SRCH Key to continue the search. The next error will be displayed. Continue pressing the SRCH Key to continue the search. The search will continue until an END instruction or the end of Program Memory is reached.

If errors are displayed, edit the program to correct the errors and check the program again. Continue checking the program until all errors have been corrected.

### 4-4-5 Test Run in MONITOR Mode

Switch the CPM1 in MONITOR mode and check the operation of the program.

- 1, 2, 3... 1. Set the Programming Console's mode switch to MONITOR mode.

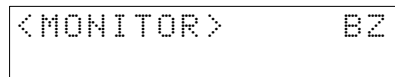
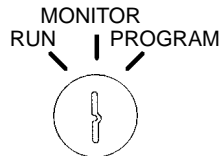

2. Press the CLR Key to bring up the initial display.

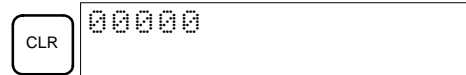

3. Force-set the start input bit (IR 00000) from the Programming Console to start the program.

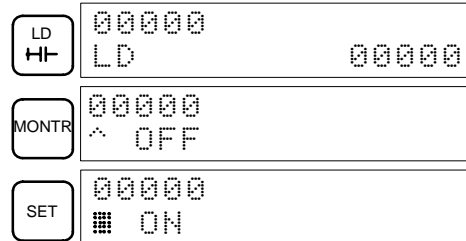

The cursor in the lower left corner of the display indicates that the force set is in progress. The bit will remain ON as long as the Set Key is held down.

4. The output indicator for output 01000 will flash ten times if the program is operating correctly. The indicator should go OFF after ten one-second flashes.

There is a mistake in the program if the output indicator doesn't flash. In this case, check the program and force set/reset bits to check operation.

# SECTION 5

## Test Runs and Error Processing

This section describes procedures for test runs of CPM1 operation, self-diagnosis functions, and error processing to identify and correct the hardware and software errors that can occur during PC operation.

5-1	Initial System Checks and Test Run Procedure .....	86
5-1-1	Initial System Checks .....	86
5-1-2	CPM1 Test Run Procedure .....	86
5-1-3	Flash Memory Precautions .....	87
5-2	The CPM1 Cycle .....	88
5-3	Self-diagnosis Functions .....	89
5-3-1	Non-fatal Errors .....	89
5-3-2	Fatal Errors .....	89
5-3-3	Identifying Errors .....	90
5-3-4	User-defined Errors .....	90
5-4	Programming Console Operation Errors .....	91
5-5	Programming Errors .....	91
5-6	Troubleshooting Flowcharts .....	93
5-7	Maintenance Inspections .....	101
5-8	Handling Precautions .....	102



## 5-1 Initial System Checks and Test Run Procedure

### 5-1-1 Initial System Checks

**Note** Check the following items after setting up and wiring the CPM1. Be sure to check the wiring and connections before performing a test run.

Item	Points to check
Power supply and I/O connections	Is the wiring correct? Are the terminals securely tightened? Are there any shorts between crimp connectors or wires? Refer to 3-4 <i>Wiring and Connections</i> for details.
Connecting cables	Are the cables all connected correctly and locked? Refer to 3-4 <i>Wiring and Connections</i> for details.
Dustproof label	Has the dustproof label been removed? Refer to 3-4 <i>Wiring and Connections</i> for details.

- Note**
1. Always clear memory before beginning to program the CPM1. Although memory is cleared before the CPU Unit is shipped (except for bits with specific functions), AR 1314, which turns ON when the internal capacitor cannot back up memory, may have turned ON during shipment.
  2. If the CPM1 will be turned off for periods exceeding the data backup period of the internal capacitor, design the system so that it will not be influenced if data in the DM, HR, and CNT areas is cleared when power is turned off.
  3. Either switch the CPM1 to RUN or MONITOR mode, or turn off and on power to the CPM1 after changing from a Programming Device any data that is backed up in flash memory. This data includes the user program, read-only DM area (DM 6144 to DM 6599), and the PC Setup (DM 6600 to DM 6655).

### 5-1-2 CPM1 Test Run Procedure

- 1, 2, 3...
1. Power Supply Application
    - a) Check the CPM1's power supply voltage and terminal connections.
    - b) Check the I/O devices' power supply voltage and terminal connections.
    - c) Turn on the power supply and check that the "POWER" indicator lights.
    - d) Use a Peripheral Device to set the CPM1 to PROGRAM mode.
  2. I/O Wiring Checks
    - a) With the CPM1 in PROGRAM mode, check the output wiring by turning on the output bits with the force set and force reset operations.  
Refer to 4-3-23 *Force Set, Reset* for details.
    - b) Check the input wiring with the CPM1's input indicators or a Peripheral Device's monitor operations.
  3. Test Run
    - a) Use a Peripheral Device to set the CPM1 to RUN or MONITOR mode and check that the "RUN" indicator lights.
    - b) Check the sequence of operation with the force set/reset operations, etc.
  4. Debugging  
Correct any programming errors that are detected.
  5. Saving the Program
    - a) Use a Peripheral Device to write the program to a backup floppy disk.
    - b) Print out a hard copy of the program with a printer.

**Note** Refer to *Section 4 Using Peripheral Devices* for details on SYSMAC Support Software or Programming Console operations.

### 5-1-3 Flash Memory Precautions

Observe the following precautions to protect the flash memory and ensure proper operation.

- 1, 2, 3...**
1. If the power is turned off without changing the mode after having made changes in the read-only DM area (DM 6144 through DM 6599), or PC Setup (DM 6600 through DM 6655), the contents of changes will not be written to flash memory. Therefore, if the power is turned off for more than 20 days (at 25°C), contents of changes (contents of the RAM) will disappear and the data values will become undefined values. For details, refer to *2-1-2 Characteristics*.  
The changes can be saved by switching the CPM1 to RUN or MONITOR mode or turning on the CPM1 soon after the changes are made.
  2. When the CPM1 is operated for the first time after changing the program, the read-only DM area (DM 6144 through DM 6599) or PC Setup (DM 6600 through DM 6655) will take about 600 ms longer than usual. Be sure to take this one-time startup delay into account.
  3. If one of the following three operations is performed in MONITOR or RUN mode, the CPM1 will extend the cycle time for up to 600 ms and interrupts will be disabled while the program or PC Setup is being overwritten.
    - Program changes with the online edit operation
    - Changes to the read-only DM area (DM 6144 through DM 6599)
    - Changes to the PC Setup (DM 6600 through DM 6655)A "SCAN TIME OVER" error won't occur during these operations. The CPM1's I/O response times may be affected when the online edit operation is being performed.

## 5-2 The CPM1 Cycle

The overall flow of CPM1 operation is as shown in the following flowchart. The CPM1 is initialized internally when the power is turned on. If no errors are detected, the overseeing processes, program execution, I/O refreshing, and Peripheral Device servicing are executed consecutively (cyclically). The average cycle time can be monitor from a Peripheral Device.

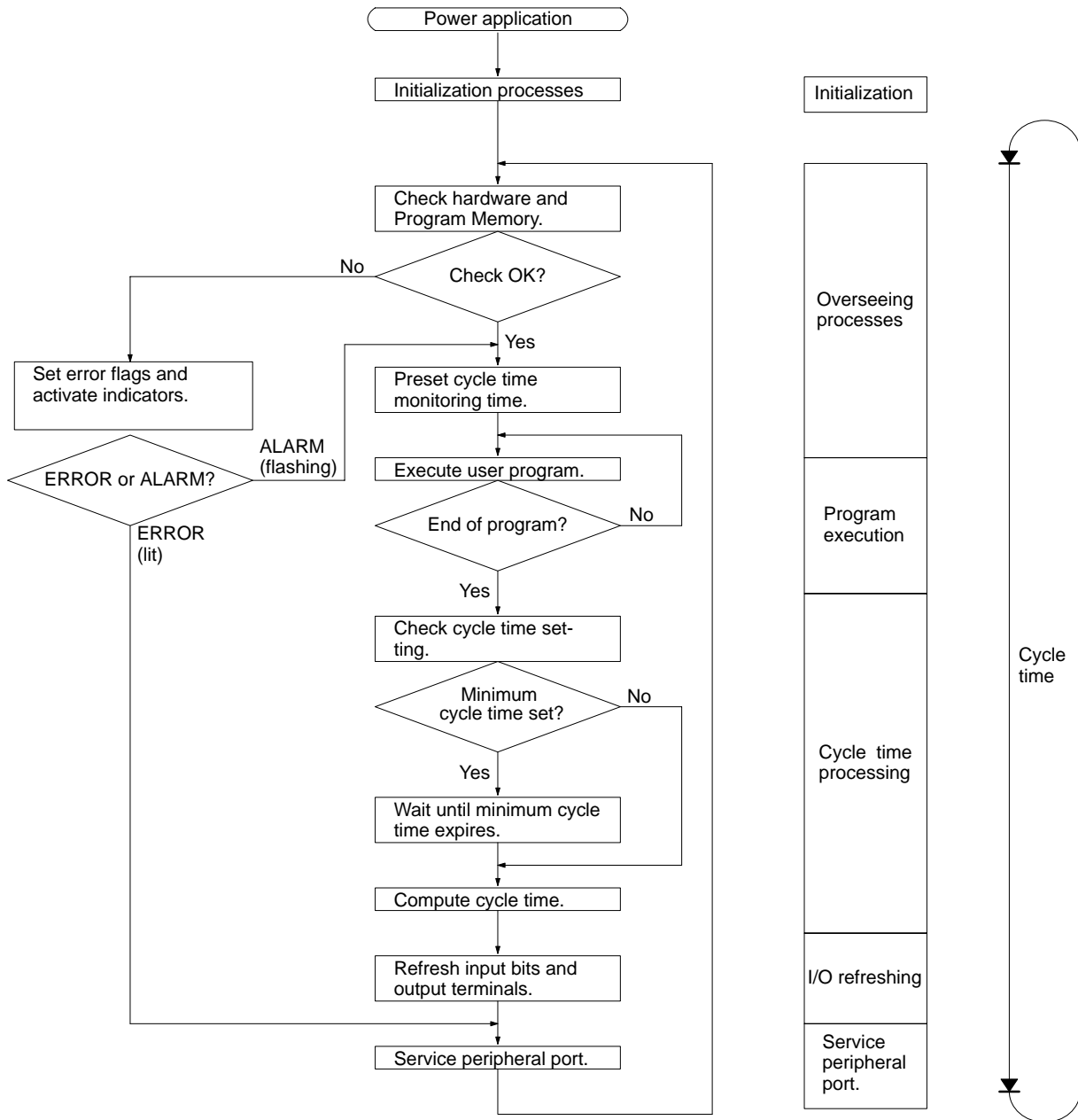

**Note** Initialization processes include clearing the IR, SR, and AR areas, presetting system timers, and checking I/O Units.

## 5-3 Self-diagnosis Functions

The CPM1 is equipped with a variety of self-diagnosis functions to help identify and correct errors that might occur and reduce down time.

PC errors are divided into 2 categories based on the severity of the errors. Fatal errors are more serious errors which stop CPM1 operation. Non-fatal errors are less serious and don't stop CPM1 operation.

### 5-3-1 Non-fatal Errors

PC operation and program execution will continue after one or more of these errors have occurred. Although PC operation will continue, the cause of the error should be corrected and the error cleared as soon as possible.

When one of these errors occurs, the POWER and RUN indicators will remain lit and the ERR/ALM indicator will flash.

Message	FAL No.	Meaning and appropriate response
SYS FAIL FAL** (** is 01 to 99 or 9B.)	01 to 99	An FAL(06) instruction has been executed in the program. Check the FAL number to determine conditions that would cause execution, correct the cause, and clear the error.
	9B	An error has been detected in the PC Setup. Check flags AR 1300 to AR 1302, and correct as directed.  AR 1300 ON: An incorrect setting was detected in the PC Setup (DM 6600 to DM 6614) when power was turned on. Correct the settings in PROGRAM Mode and turn on the power again.  AR 1301 ON: An incorrect setting was detected in the PC Setup (DM 6615 to DM 6644) when switching to RUN Mode. Correct the settings in PROGRAM Mode and switch to RUN Mode again.  AR 1302 ON: An incorrect setting was detected in the PC Setup (DM 6645 to DM 6655) during operation. Correct the settings and clear the error.
SCAN TIME OVER	F8	Watchdog timer has exceeded 100 ms. (SR 25309 will be ON.)  This indicates that the program cycle time is longer than recommended. Reduce cycle time if possible. (The CPM1 can be set so that this error won't be detected.)
Communication Errors (no message)	None	If an error occurs in communications through the peripheral port, the COMM indicator will be off. Check the connecting cables and restart. Check the error flags in AR 0812 ON.

### 5-3-2 Fatal Errors

PC operation and program execution will stop and all outputs from the PC will be turned OFF when any of these errors have occurred. CPM1 operation can't be restarted until the PC is turned off and then on again or a Peripheral Device is used to switch the PC to PROGRAM mode and clear the fatal error.

All CPU Unit indicators will be OFF for the power interruption error. For all other fatal operating errors, the POWER and ERR/ALM indicators will be lit. The RUN indicator will be OFF.

Message	FALS No.	Meaning and appropriate response
Power interruption (no message)	None	Power has been interrupted for at least 10 ms for the AC-type CPU Unit and at least 2 ms for the DC-type CPU Unit. Check power supply voltage and power lines. Try to power-up again.
MEMORY ERR	F1	AR 1308 ON: An unspecified bit area exists in the user program. Check the program and correct errors.
		AR 1309 ON: An error has occurred in reading or writing flash memory. Replace the CPU Unit.
		AR 1310 ON: A checksum error has occurred in read-only DM (DM 6144 to DM 6599). Check and correct the settings in the read-only DM area.
		AR 1311 ON: A checksum error has occurred in the PC Setup. Initialize all of the PC Setup and reinput.
		AR 1312 ON: A checksum error has occurred in the program. Check the program and correct any errors detected.
		AR 1314 ON: The internal capacitor can no longer back up data. Clear the error and check/correct the contents of the data areas backed up by the capacitor.
NO END INST	F0	END(01) is not written in the program. Write END(01) at the end of the program.
I/O BUS ERR	C0	An error has occurred during data transfer between the CPU Unit and Expansion I/O Unit. Check the Expansion I/O Unit's connecting cable.
I/O UNIT OVER	E1	Too many I/O Units have been connected. Check the I/O Unit configuration.
SYS FAIL FALS** (** is 01 to 99 or 9F.)	01 to 99	A FALS(07) instruction has been executed in the program. Check the FALS number to determine the conditions that caused execution, correct the cause, and clear the error.
	9F	The cycle time has exceeded the FALS 9F Cycle Time Monitoring Time (DM 6618). Check the cycle time and adjust the Cycle Time Monitoring Time if necessary.

### 5-3-3 Identifying Errors

PC errors can be identified from error messages displayed on the Programming Console, error flags in the SR or AR areas, and the error code in SR 25300 to SR 25307.

#### Error Messages

Error messages generated by the self-diagnosis function can be read from a Programming Console or host computer running SYSMAC Support Software.

#### Error Flags

When the self-diagnosis function detects a hardware error, it will turn on the corresponding error flags in the SR and AR areas.

#### Error Code

When an error is detected by the self-diagnosis function, the corresponding error code is written to SR 25300 to SR 25307. (The error code is a 2-digit hexadecimal code.)

### 5-3-4 User-defined Errors

There are three instructions that the user can use to define his own errors or messages. FAL(06) causes a non-fatal error, FAL(07) causes a fatal error, and MSG(46) sends a message to the Programming Console or host computer connected to the PC.

#### FAILURE ALARM – FAL(06)

FAL(06) is an instruction that causes a non-fatal error. The following will occur when an FAL(06) instruction is executed:

- 1, 2, 3... 1. The ERR/ALM indicator on the CPU Unit will flash. PC operation will continue.
2. The instruction's 2-digit BCD FAL number (01 to 99) will be written to SR 25300 to SR 25307.

The FAL numbers can be set arbitrarily to indicate particular conditions. The same number cannot be used as both an FAL number and a FALS number.

To clear an FAL error, correct the cause of the error and then execute FAL 00 or clear the error using the Programming Console.

**SEVERE FAILURE ALARM – FALS(07)** FALS(07) is an instruction that causes a fatal error. The following will occur when an FALS(07) instruction is executed:

- 1, 2, 3...**
1. Program execution will be stopped and outputs will be turned OFF.
  2. The ERR/ALM indicator on the CPU Unit will be lit.
  3. The instruction's 2-digit BCD FALS number (01 to 99) will be written to SR 25300 to SR 25307.
  4. The FALS number and time of occurrence will be recorded in the PC's error log area if a Memory Cassette with a clock (RTC) is used.

The FALS numbers can be set arbitrarily to indicate particular conditions. The same number cannot be used as both an FAL number and an FALS number.

To clear an FALS error, switch the PC to PROGRAM Mode, correct the cause of the error, and then clear the error using the Programming Console.

**MESSAGE – MSG(46)**

MSG(46) is used to display a message on the Programming Console. The message, which can be up to 16 characters long, is displayed when the instruction's execution condition is ON.

## 5-4 Programming Console Operation Errors

The following error messages may appear when performing operations on the Programming Console. Correct the error as indicated and continue with the operation. Refer to the *Ladder Support Software Operation Manual*, *SYSMAC Support Software Operation Manual: C-series PCs*, and *Data Access Console Operation Manual* for errors that may appear when operating the SSS or a Data Access Console.

Message	Meaning and appropriate response
REPL ROM	An attempt was made to write to write-protected memory. Set bits 00 to 03 of DM 6602 to "0."
PROG OVER	The instruction at the last address in memory is not NOP(00). Erase all unnecessary instructions at the end of the program.
ADDR OVER	An address was set that is larger than the highest memory address in Program Memory. Input a smaller address.
SETDATA ERR	FALS 00 has been input, and "00" cannot be input. Reinput the data.
I/O NO. ERR	A data area address has been designated that exceeds the limit of the data area, e.g., an address is too large. Confirm the requirements for the instruction and re-enter the address.

## 5-5 Programming Errors

These errors in program syntax will be detected when the program is checked using the Program Check operation.

Three levels of program checking are available. The desired level must be designated to indicate the type of errors that are to be detected. The following table provides the error types, displays, and explanations of all syntax errors. Check

level 0 checks for type A, B, and C errors; check level 1, for type A and B errors; and check level 2, for type A errors only.

Type	Message	Meaning and appropriate response
A	?????	The program has been damaged, creating a non-existent function code. Re-enter the program.
	CIRCUIT ERR	The number of logic blocks and logic block instructions does not agree, i.e., either LD or LD NOT has been used to start a logic block whose execution condition has not been used by another instruction, or a logic block instruction has been used that does not have the required number of logic blocks. Check your program.
	OPERAND ERR	A constant entered for the instruction is not within defined values. Change the constant so that it lies within the proper range.
	NO END INSTR	There is no END(001) in the program. Write END(001) at the final address in the program.
	LOCN ERR	An instruction is in the wrong place in the program. Check instruction requirements and correct the program.
	JME UNDEFD	A JME(004) instruction is missing for a JMP(005) instruction. Correct the jump number or insert the proper JME(004) instruction.
	DUPL	The same jump number or subroutine number has been used twice. Correct the program so that the same number is only used once for each.
	SBN UNDEFD	The SBS(091) instruction has been programmed for a subroutine number that does not exist. Correct the subroutine number or program the required subroutine.
	STEP ERR	STEP(008) with a section number and STEP(008) without a section number have been used incorrectly. Check STEP(008) programming requirements and correct the program.
B	IL-ILC ERR	IL(002) and ILC(003) are not used in pairs. Correct the program so that each IL(002) has a unique ILC(003). Although this error message will appear if more than one IL(002) is used with the same ILC(003), the program will executed as written. Make sure your program is written as desired before proceeding.
	JMP-JME ERR	JMP(004) and JME(005) are not used in pairs. Make sure your program is written as desired before proceeding.
	SBN-RET ERR	If the displayed address is that of SBN(092), two different subroutines have been defined with the same subroutine number. Change one of the subroutine numbers or delete one of the subroutines. If the displayed address is that of RET(093), RET(093) has not been used properly. Check requirements for RET(093) and correct the program.
C	COIL DUPL	The same bit is being controlled (i.e., turned ON and/or OFF) by more than one instruction (e.g., OUT, OUT NOT, DIFU(13), DIFD(14), KEEP(11), SFT(10)). Although this is allowed for certain instructions, check instruction requirements to confirm that the program is correct or rewrite the program so that each bit is controlled by only one instruction.
	JMP UNDEFD	JME(005) has been used with no JMP(004) with the same jump number. Add a JMP(004) with the same number or delete the JME(005) that is not being used.
	SBS UNDEFD	A subroutine exists that is not called by SBS(091). Program a subroutine call in the proper place, or delete the subroutine if it is not required.

# 5-6 Troubleshooting Flowcharts

Use the following flowcharts to troubleshoot errors that occur during operation.

## Main Check

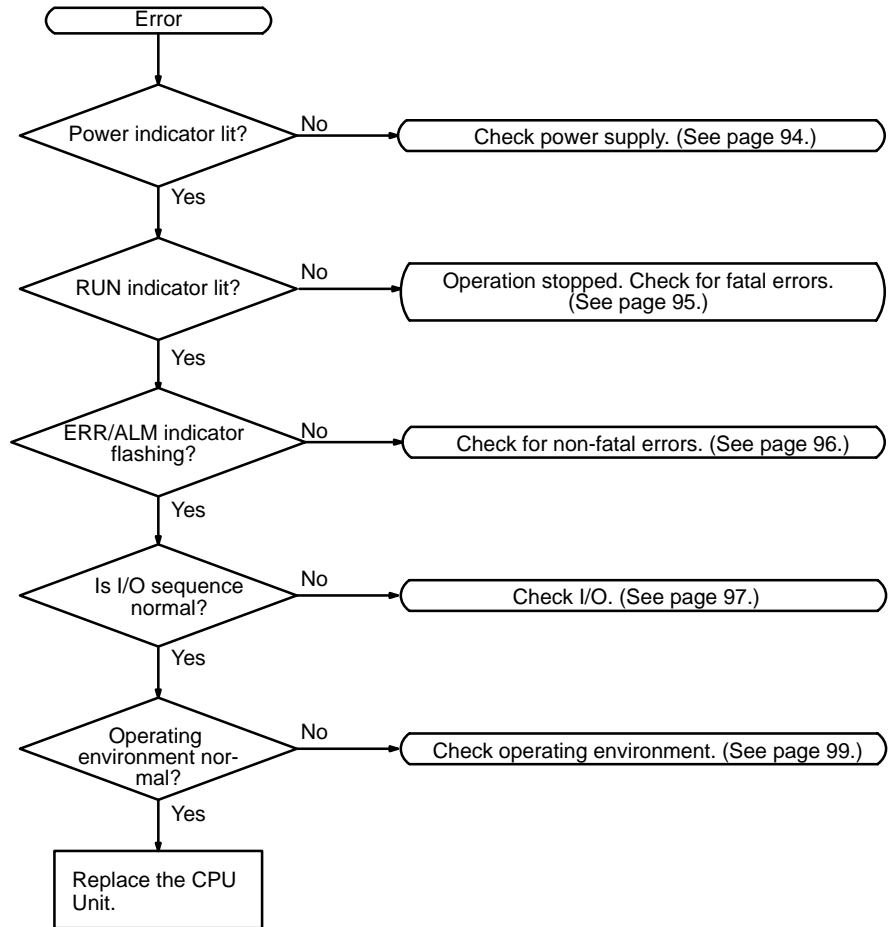



Power Supply Check

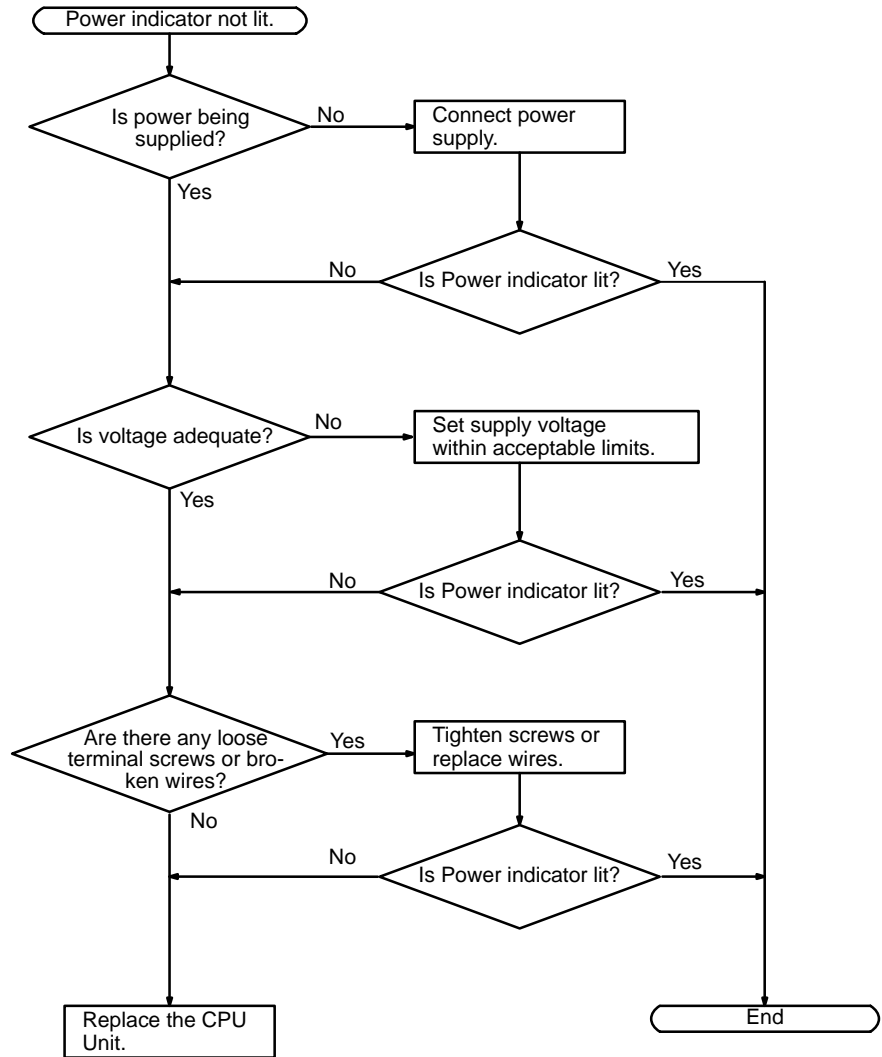

Fatal Error Check

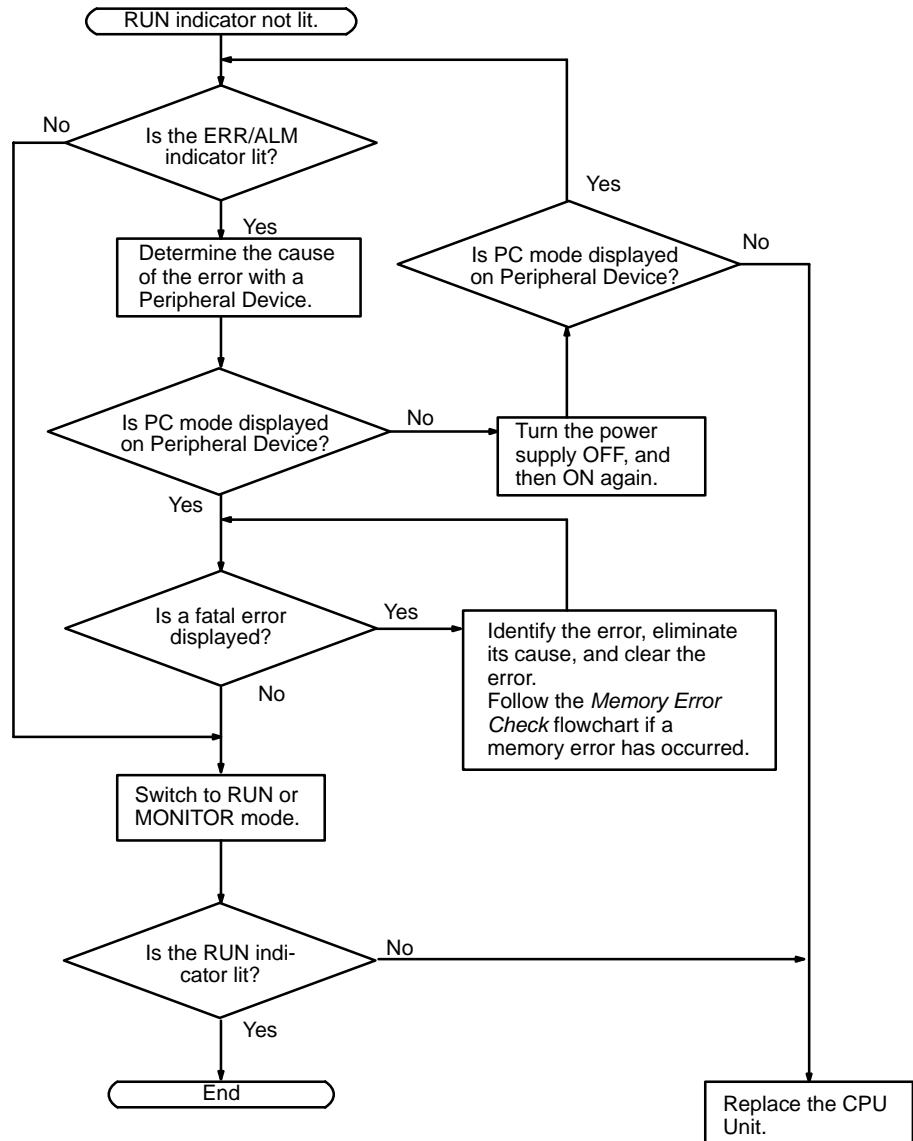

Non-fatal Error Check

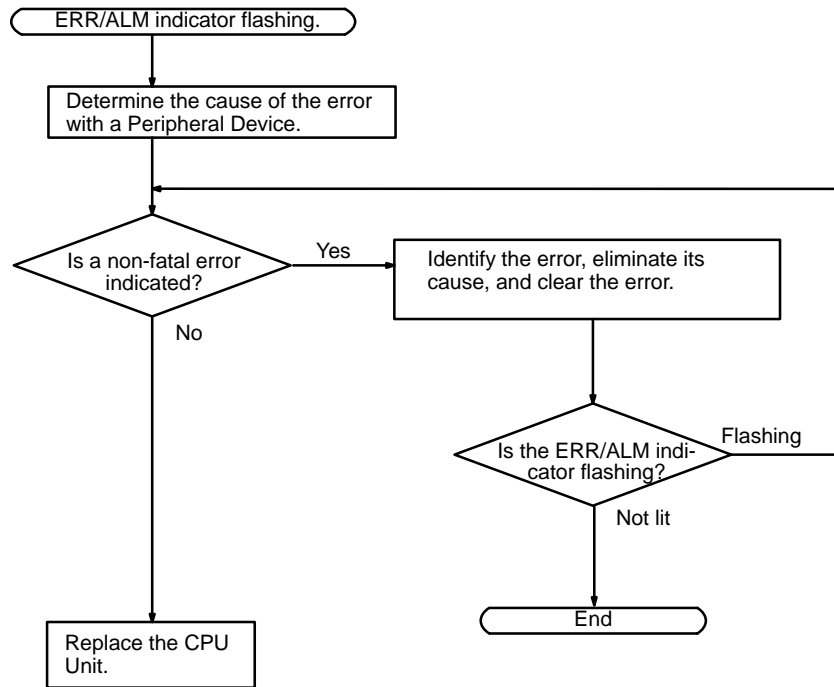

I/O Check

The I/O check flowchart is based on the following ladder diagram section.

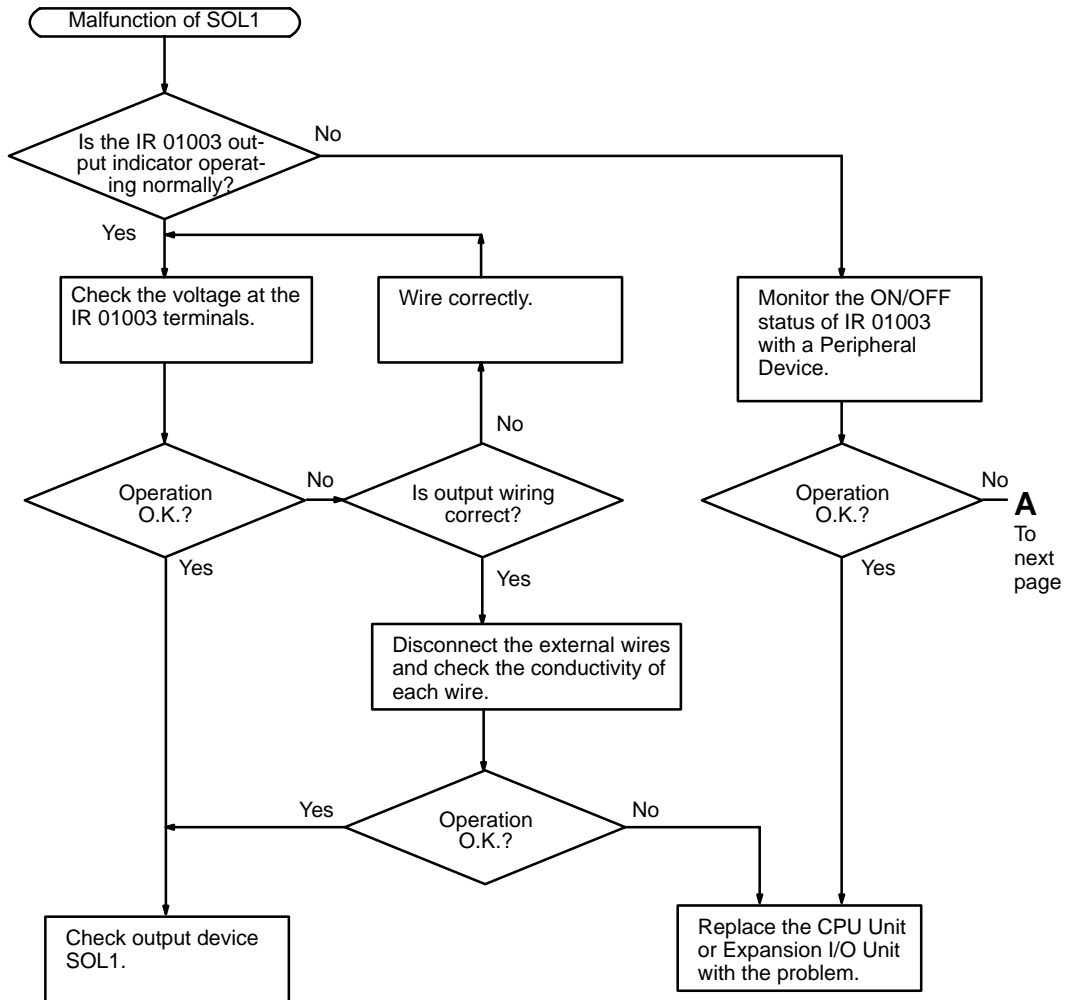
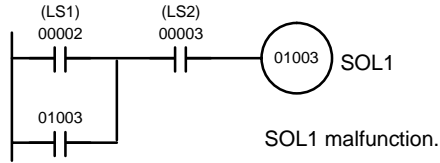

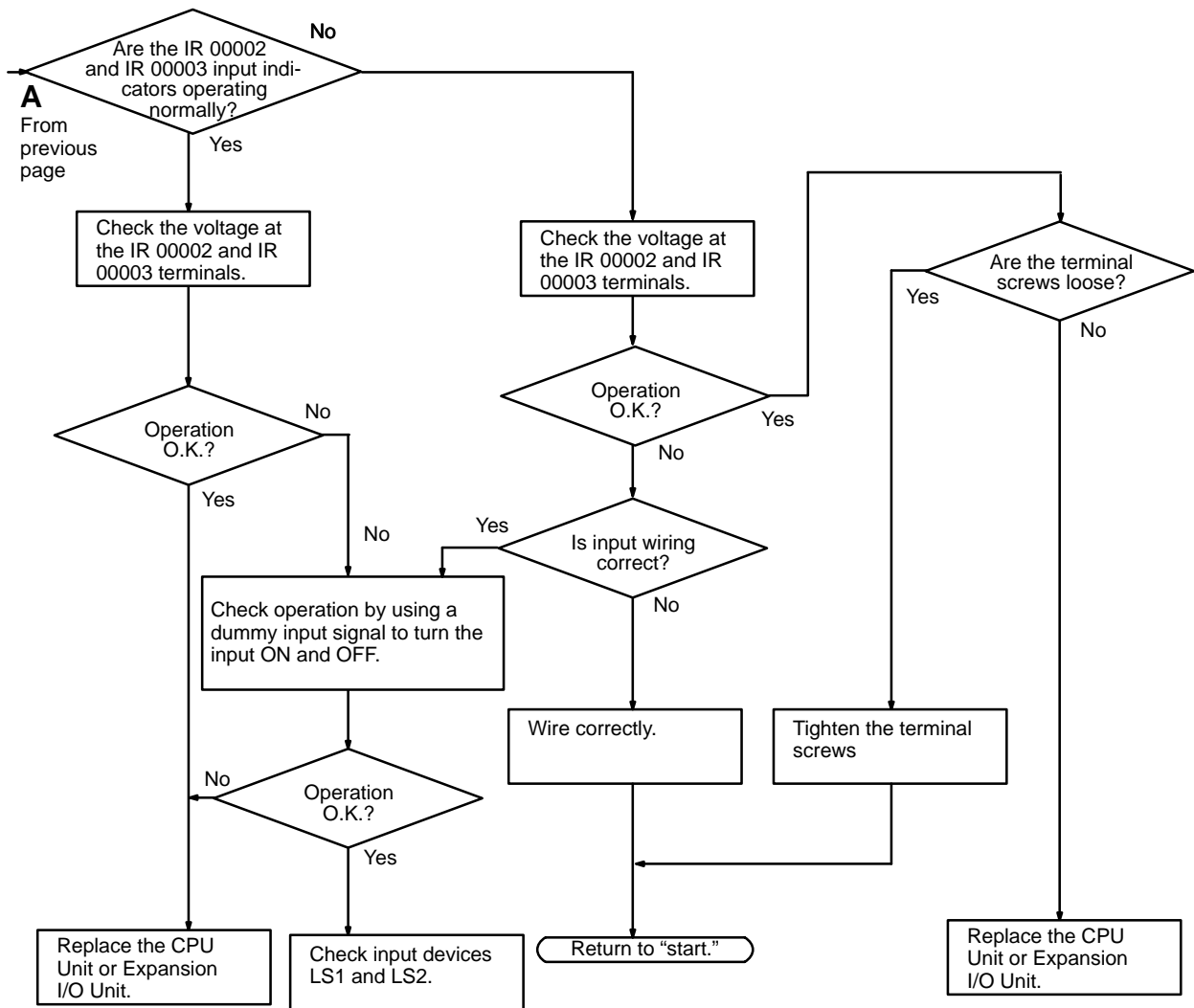

Environmental Conditions Check

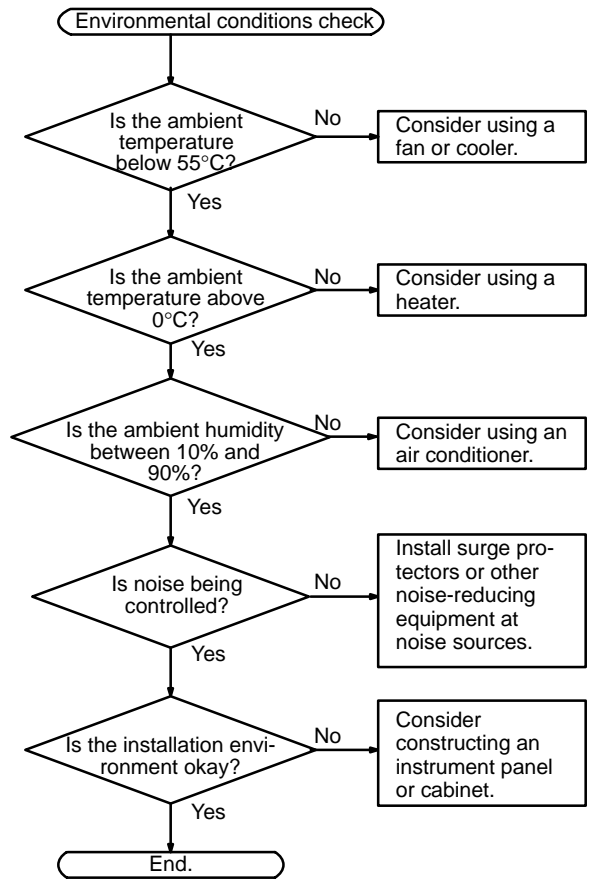

Memory Error Check

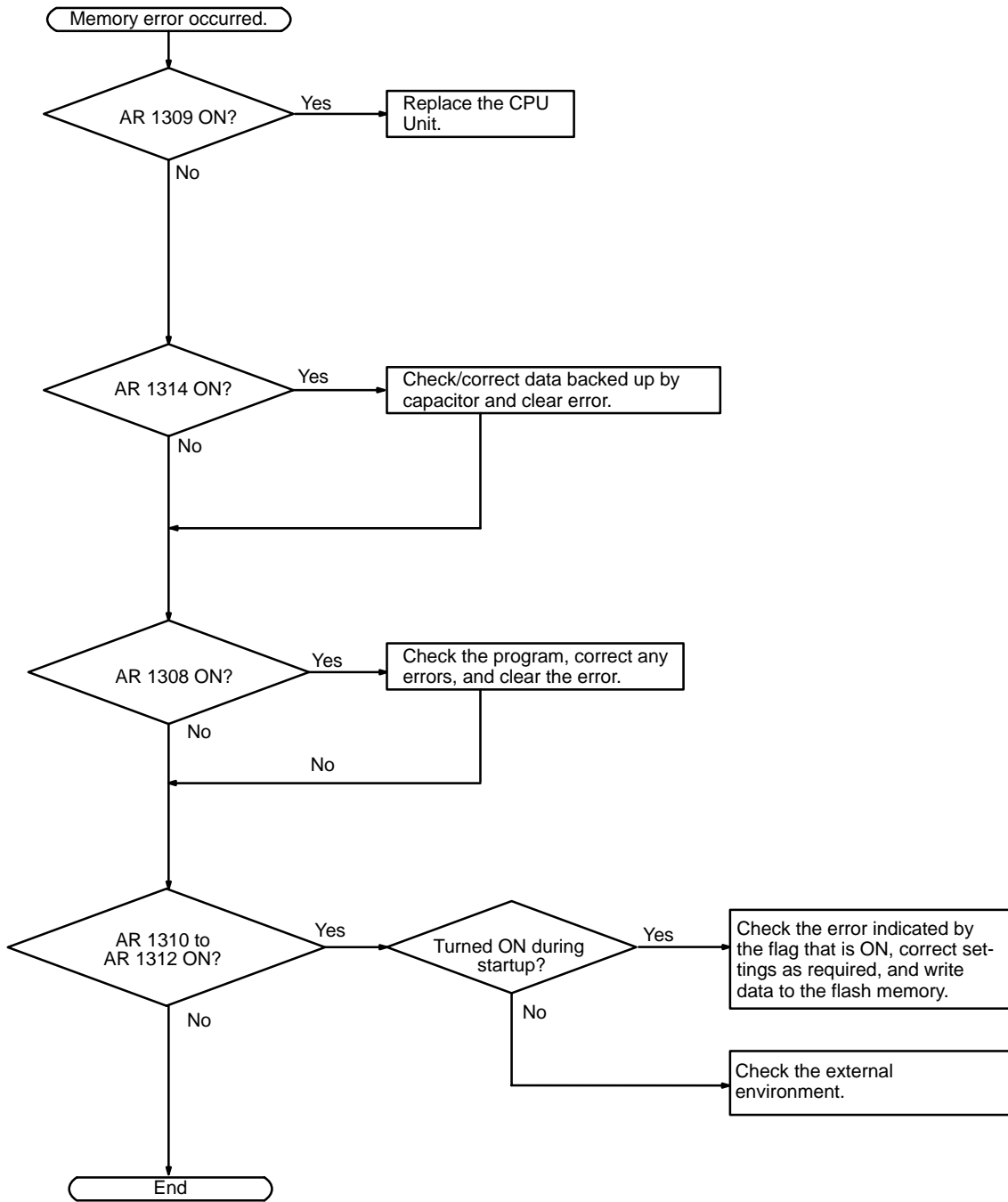

## 5-7 Maintenance Inspections

In order that your SYSMAC system operates in optimum condition, be sure to carry out daily or periodical inspections.

### Inspection Items

The main system components of a SYSMAC system are semiconductors, and it contains few components with limited lifetimes. Environmental conditions, however, can lead to electrical element deterioration, making regular maintenance necessary.

The standard period for maintenance checks is 6 months to 1 year, but depending on the environment checks may need to be more regular.

If the criteria are not met, adjust to within the specified ranges.

Inspection items	Details	Criteria	Remarks
Power supply	Determine whether the voltage fluctuation is within the standard at the power supply terminal.	Within the voltage variation range (see note)	Tester
Environmental conditions	Is the ambient temperature inside the panel appropriate?	0 to 55°C	Thermometer
	Is the ambient humidity inside the panel appropriate?	10% to 90% RH with no condensation	Hydroscope
	Has dirt or dust collected?	None	Visual inspection
I/O power supply	Is the voltage fluctuation measured at the I/O terminal within the standard range?	Each I/O must conform to the specifications	Tester
Installation status	Are all units securely installed?	Nothing is loose	Positive screwdriver
	Are all connection cables and connectors inserted completely and locked?	Nothing is loose	Visual inspection
	Are any of the external wiring screws loose?	Nothing is loose	Positive screwdriver
	Are any of the external wiring cables frayed?	No external abnormalities	Visual inspection
Product service life	Contact output relay	Electrical: Resistance load: 300,000 operations Inductive load: 100,000 operations  Mechanical: 10,000,000 operations	

**Note** Power supply voltage variation range.

Power supply	Allowable voltage fluctuation range
100 to 120 VAC	85 to 132 VAC
200 to 240 VAC	170 to 264 VAC
24 VDC	20.4 to 26.4 VDC



## 5-8 Handling Precautions

- Turn the power OFF before replacing the Unit.

**Note** Before restarting operation, transfer the contents of the DM and HR areas to the CPU Unit that was changed and then start operation.

- If a Unit is found to be faulty and is replaced, check the Unit again to ensure there is no error.
- When returning a faulty Unit for repair, make a detailed note of the Unit's malfunction and take it together with the Unit to your nearest OMRON office or sales representative.
- If a contact is not good, put some industrial alcohol on a clean cotton cloth and wipe the surface. After doing this, install the Unit.

### **Necessary Tools for Inspection**

#### **Standard Tools**

- Screwdrivers (Philips and flat-blade)
- Voltage tester or digital voltage meter
- Industrial alcohol and a cotton cloth



#### **Measurement Devices**

- Synchroscope
- Cathode-ray oscilloscope
- Thermometer, hydroscope

**Note** Do not take apart, repair or remodel the PC in any way.

# Appendix A Standard Models

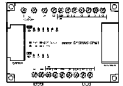
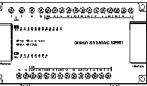
## CPU Units

Description	Input points	Output points	Power Supply	Model Number
CPU Units with 10 I/O points 	6 points	4 points	100 to 240 VAC, 50/60 Hz	CPM1-10CDR-A
			24 VDC	CPM1-10CDR-D
CPU Units with 20 I/O points 	12 points	8 points	100 to 240 VAC, 50/60 Hz	CPM1-20CDR-A
			24 VDC	CPM1-20CDR-D
CPU Units with 30 I/O points 	18 points	12 points	100 to 240 VAC, 50/60 Hz	CPM1-30CDR-A
			24 VDC	CPM1-30CDR-D
			100 to 240 VAC, 50/60 Hz	CPM1-30CDR-A-V1 (Available soon)
			24 VDC	CPM1-30CDR-D-V1 (Available soon)

## Expansion I/O Units

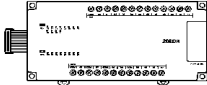
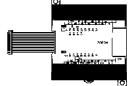
Description	Input points	Output points	Specifications	Model Number
 	12 points	8 points	Expansion I/O Unit with 20 I/O points	CPM1-20EDR
			Expansion I/O Unit with 20 I/O points Transistor output (sink type)	CPM1A-20EDT
			Expansion I/O Unit with 20 I/O points Transistor output (source type)	CPM1A-20EDT1

## Communications Adapters

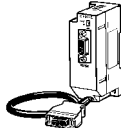
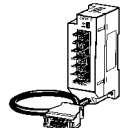
Description	Output points	Model Number
RS-232C Adapter 	Converts data communications between the peripheral port and RS-232C devices.	CPM1-CIF01
RS-422 Adapter 	Converts data communications between the peripheral port and RS-422 devices.	CPM1-CIF11

The CPM1-CIF01/CIF11 are used with the CPM1A, CPM1, and SRM1 only. Do not use them with a C200HS PC or other PC.

## Peripheral Devices

Name	Model Number	Specifications
Programming Console	CQM1-PRO01-E	2-m Connecting Cable attached
	C200H-PRO27-E	Hand-held, w/backlight; requires the C200H-CN222 or C200H-CN422 Connecting Cable, see below
SYSMAC Support Software	C500-ZL3AT1-E	3.5", 2HD for IBM PC/AT compatible
SYSMAC-CPT	WS01-CPTB1-E	For IBM PC/AT or compatible computers (3.5" disks (2HD) and CDROM)
Connecting Cable	CQM1-CIF02	Connects IBM PC/AT or compatible computers to Peripheral Port
	C200H-CN222	Connects C200H Programming Console to Peripheral Port (2 m)
	C200H-CN422	Connects C200H Programming Console to Peripheral Port (4 m)

# Appendix B Dimensions

All dimensions are in millimeters.

## CPM1-10CDR-□

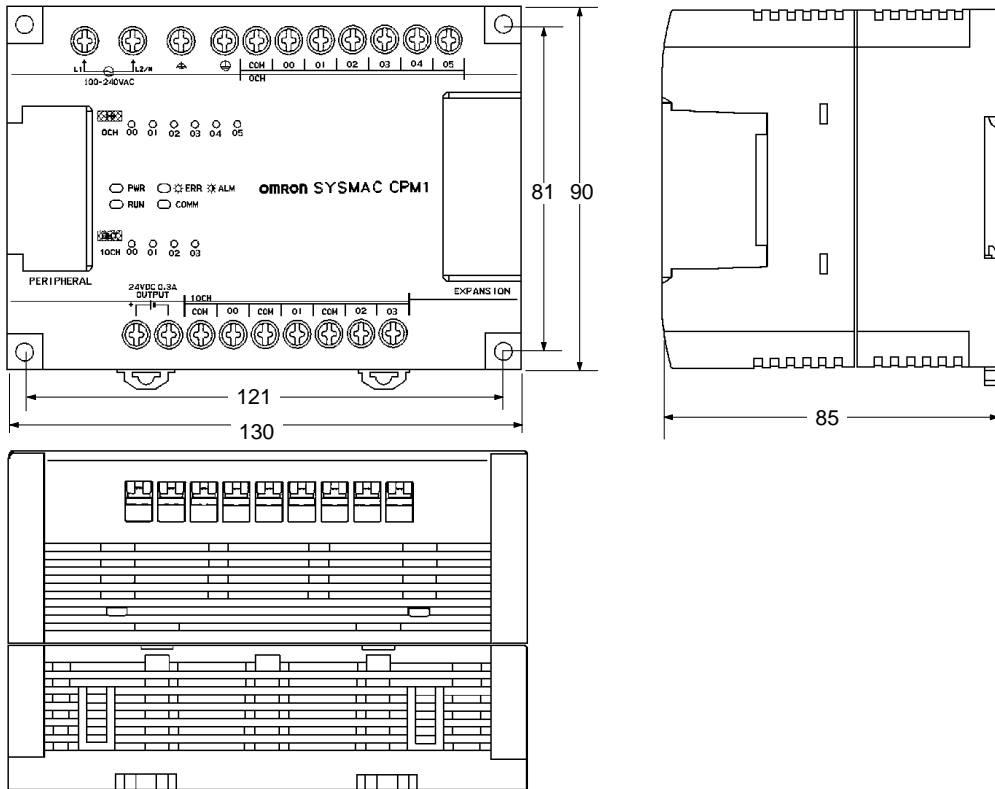

**CPM1-20CDR-□**

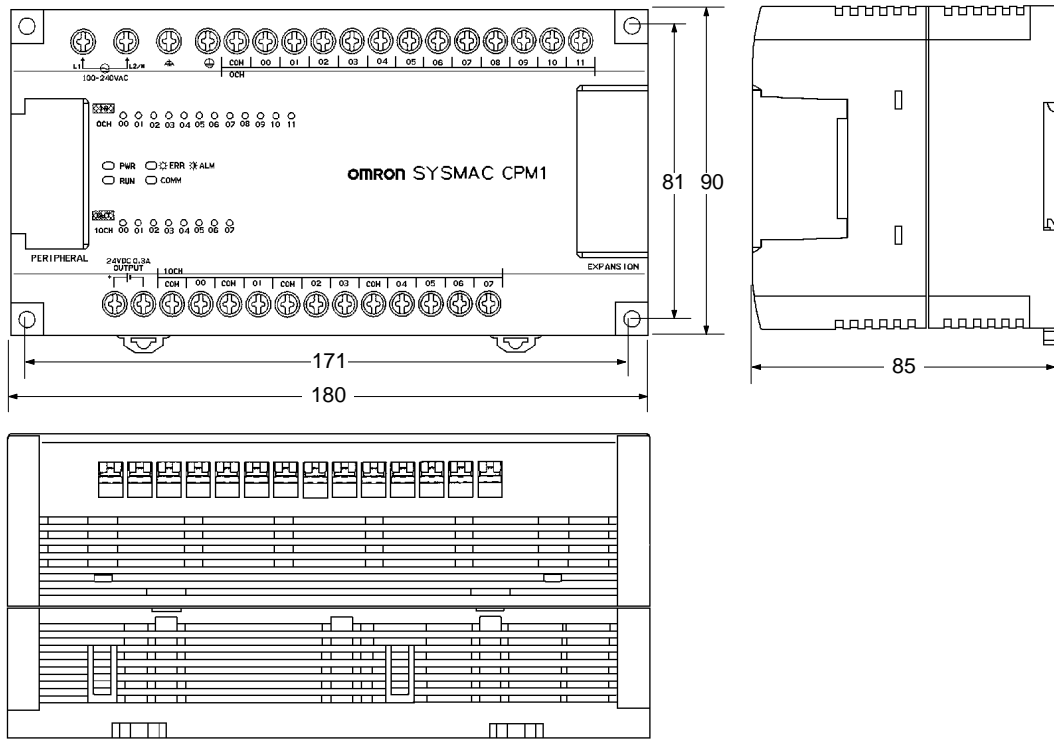

**CPM1-30CDR-□**  
**CPM1-30CDR-□-V1 (Available soon)**

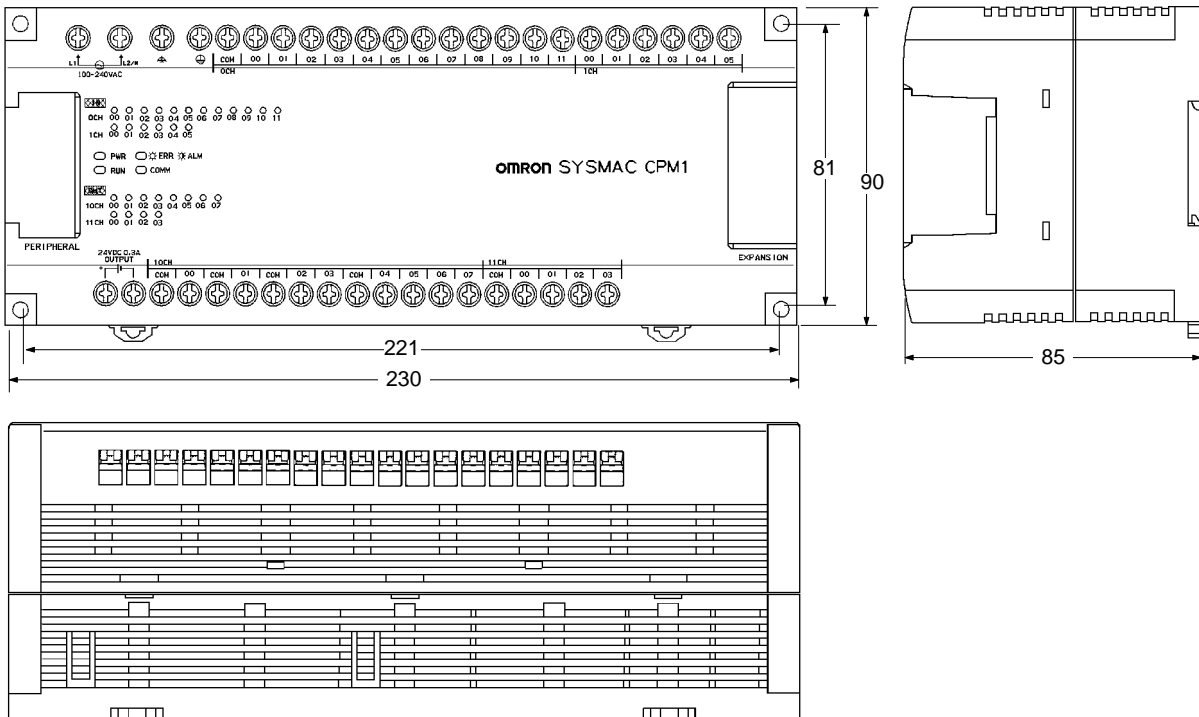

# CPM1-20EDR

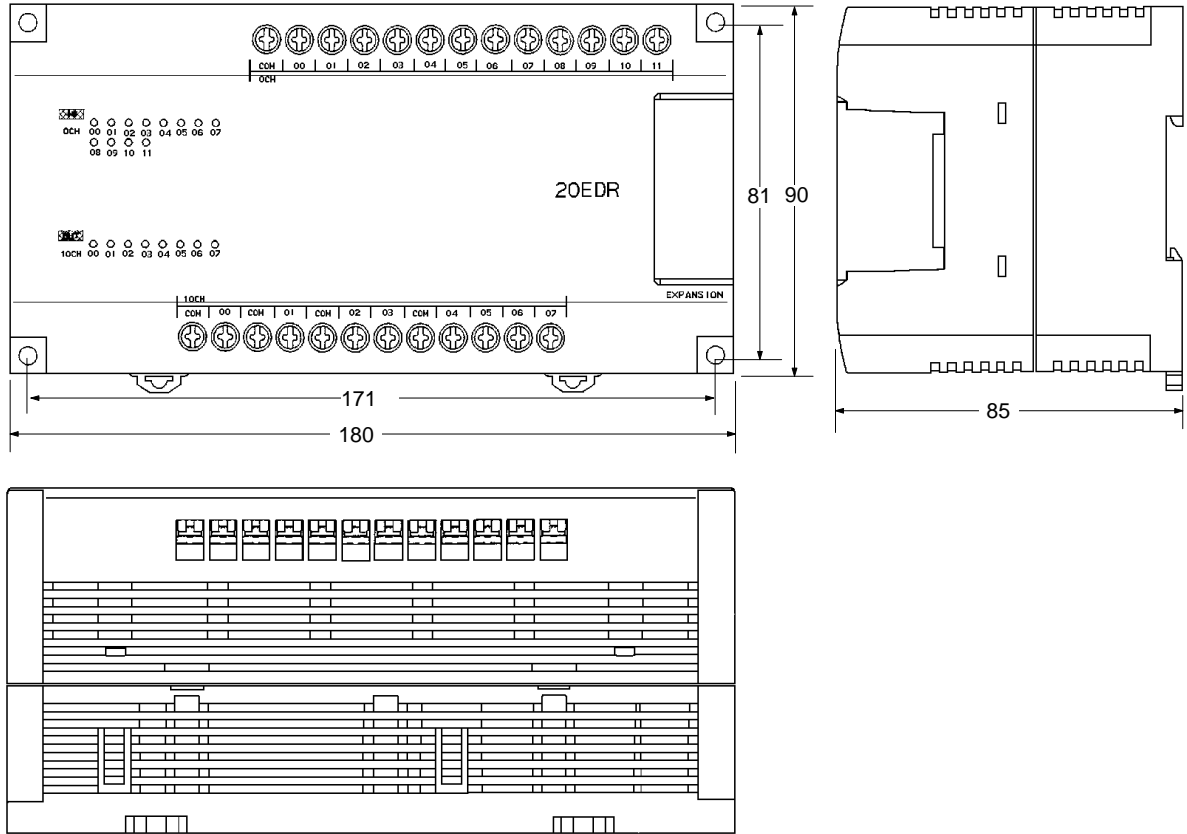

### CPM1-CIF01

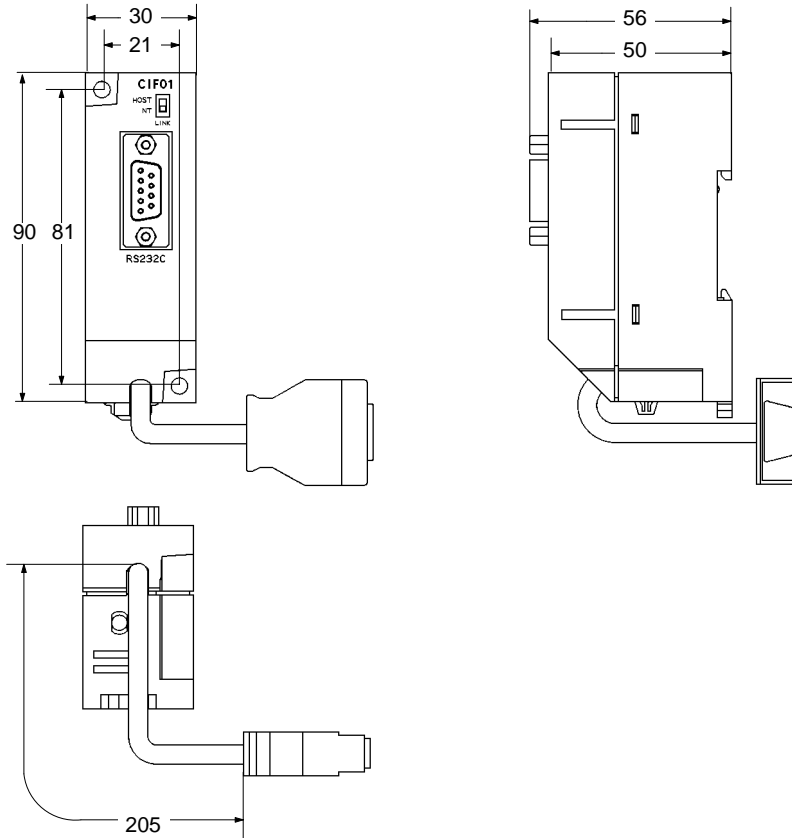

### CPM1-CIF11

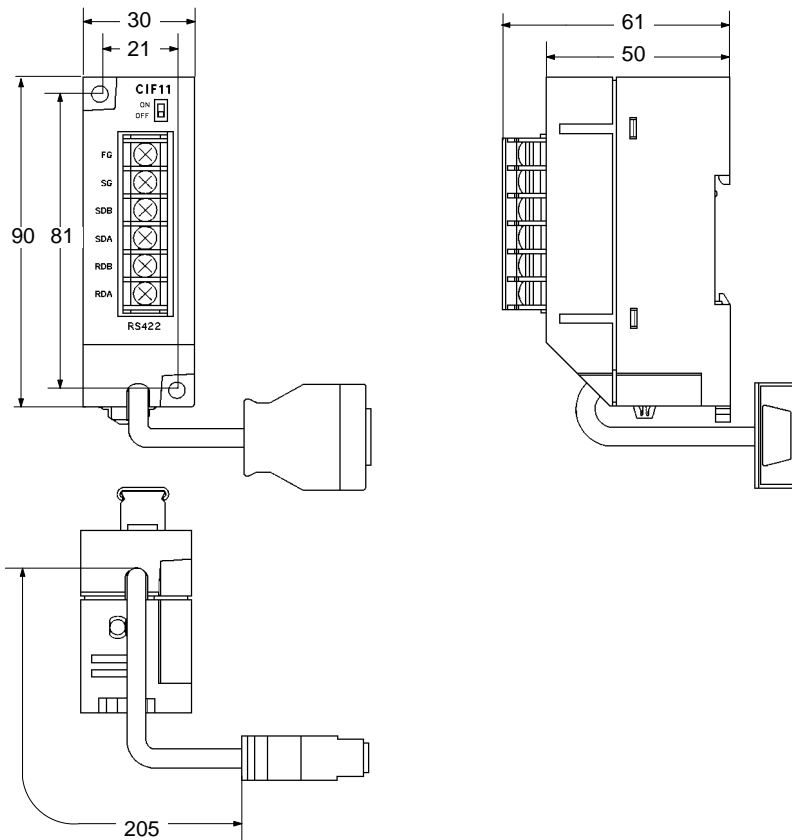

### Dimensions with Peripheral Devices Attached

#### CPM1-□□CDR-□

When the Communications Adapter or Programming Console is attached.

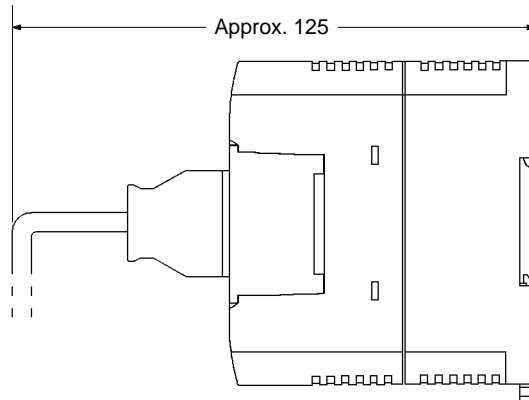

#### CPM1-CIF01

When the RS-232C connector is attached.

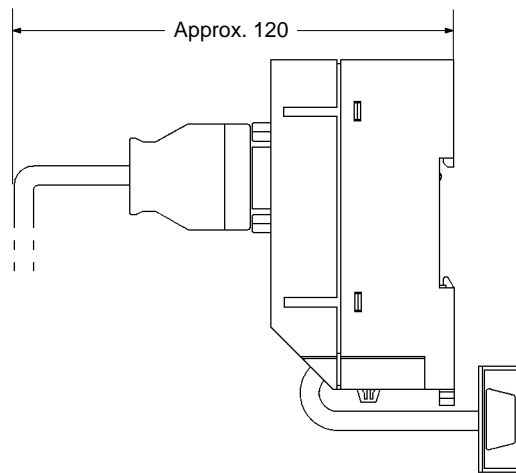



# Glossary

<b>*DM</b>	Indirectly addressed DM area. See <i>indirect address</i> and <i>DM area</i> .
<b>1:1 link</b>	A link created between two PCs to create <i>common data</i> in their LR areas.
<b>ACP</b>	See <i>add count input</i> .
<b>add count input</b>	An input signal used to increment a counter when the signal changes from OFF to ON.
<b>address</b>	A number used to identify the location of data or programming instructions in memory.
<b>AND</b>	A logic operation whereby the result is true if and only if both premises are true. In ladder-diagram programming the premises are usually ON/OFF states of bits or the logical combination of such states called execution conditions.
<b>area</b>	See <i>data area</i> and <i>memory area</i> .
<b>area prefix</b>	A one or two letter prefix used to identify a memory area in the PC. All memory areas except the IR and SR areas require prefixes to identify addresses in them.
<b>arithmetic shift</b>	A shift operation wherein the carry flag is included in the shift.
<b>ASCII</b>	Short for American Standard Code for Information Interchange. ASCII is used to code characters for output to printers and other external devices.
<b>AR Area</b>	A PC data area allocated to flags and control bits.
<b>AUTOEXEC.BAT</b>	An MS DOS file containing commands automatically executed at startup.
<b>back-up</b>	A copy made of existing data to ensure that the data will not be lost even if the original data is corrupted or erased.
<b>basic instruction</b>	A fundamental instruction used in a ladder diagram. See <i>advanced instruction</i> .
<b>baud rate</b>	The data transmission speed between two devices in a system measured in bits per second.
<b>BCD</b>	See <i>binary-coded decimal</i> .
<b>BCD calculation</b>	An arithmetic calculation that uses numbers expressed in binary-coded decimal.
<b>binary</b>	A number system where all numbers are expressed in base 2, i.e., numbers are written using only 0's and 1's. Each group of four binary bits is equivalent to one hexadecimal digit. Binary data in memory is thus often expressed in hexadecimal for convenience.
<b>binary calculation</b>	An arithmetic calculation that uses numbers expressed in binary.
<b>binary-coded decimal</b>	A system used to represent numbers so that every four binary bits is numerically equivalent to one decimal digit.
<b>bit</b>	The smallest piece of information that can be represented on a computer. A bit has the value of either zero or one, corresponding to the electrical signals ON and OFF. A bit represents one binary digit. Some bits at particular addresses are allocated to special purposes, such as holding the status of input from external devices, while other bits are available for general use in programming.
<b>bit address</b>	The location in memory where a bit of data is stored. A bit address specifies the data area and word that is being addressed as well as the number of the bit within the word.

<b>bit designator</b>	An operand that is used to designate the bit or bits of a word to be used by an instruction.
<b>bit number</b>	A number that indicates the location of a bit within a word. Bit 00 is the rightmost (least-significant) bit; bit 15 is the leftmost (most-significant) bit.
<b>bit-control instruction</b>	An instruction that is used to control the status of an individual bit as opposed to the status of an entire word.
<b>block</b>	See <i>logic block</i> and <i>instruction block</i> .
<b>building-block PC</b>	A PC that is constructed from individual components, or “building blocks.” With building-block PCs, there is no one Unit that is independently identifiable as a PC. The PC is rather a functional assembly of Units.
<b>bus</b>	A communications path used to pass data between any of the Units connected to it.
<b>bus bar</b>	The line leading down the left and sometimes right side of a ladder diagram. Instruction execution proceeds down the bus bar, which is the starting point for all instruction lines.
<b>byte</b>	A unit of data equivalent to 8 bits, i.e., half a word.
<b>call</b>	A process by which instruction execution shifts from the main program to a subroutine. The subroutine may be called by an instruction or by an interrupt.
<b>Carry Flag</b>	A flag that is used with arithmetic operations to hold a carry from an addition or multiplication operation, or to indicate that the result is negative in a subtraction operation. The carry flag is also used with certain types of shift operations.
<b>central processing unit</b>	A device that is capable of storing programs and data, and executing the instructions contained in the programs. In a PC System, the central processing unit executes the program, processes I/O signals, communicates with external devices, etc.
<b>CH</b>	See <i>word</i> .
<b>channel</b>	See <i>word</i> .
<b>character code</b>	A numeric (usually binary) code used to represent an alphanumeric character.
<b>checksum</b>	A sum transmitted with a data pack in communications. The checksum can be recalculated from the received data to confirm that the data in the transmission has not been corrupted.
<b>clock pulse</b>	A pulse available at specific bits in memory for use in timing operations. Various clock pulses are available with different pulse widths, and therefore different frequencies.
<b>clock pulse bit</b>	A bit in memory that supplies a pulse that can be used to time operations. Various clock pulse bits are available with different pulse widths, and therefore different frequencies.
<b>common data</b>	Data that is stored in a memory of a PC and which is shared by other PCs in the same the same system. Each PC has a specified section(s) of the area allocated to it. Each PC writes to the section(s) allocated to it and reads the sections allocated to the other PCs with which it shares the common data.
<b>communications cable</b>	Cable used to transfer data between components of a control system and conforming to the RS-232C or RS-422 standards.
<b>comparison instruction</b>	An instruction used to compare data at different locations in memory to determine the relationship between the data.

<b>Completion Flag</b>	A flag used with a timer or counter that turns ON when the timer has timed out or the counter has reached its set value.
<b>condition</b>	A symbol placed on an instruction line to indicate an instruction that controls the execution condition for the terminal instruction. Each condition is assigned a bit in memory that determines its status. The status of the bit assigned to each condition determines the next execution condition. Conditions correspond to LOAD, LOAD NOT, AND, AND NOT, OR, or OR NOT instructions.
<b>CONFIG.SYS</b>	An MS DOS file containing environment settings for a personal computer.
<b>constant</b>	An input for an operand in which the actual numeric value is specified. Constants can be input for certain operands in place of memory area addresses. Some operands must be input as constants.
<b>control bit</b>	A bit in a memory area that is set either through the program or via a Programming Device to achieve a specific purpose, e.g., a Restart Bit is turned ON and OFF to restart a Unit.
<b>control data</b>	An operand that specifies how an instruction is to be executed. The control data may specify the part of a word is to be used as the operand, it may specify the destination for a data transfer instructions, it may specify the size of a data table used in an instruction, etc.
<b>control signal</b>	A signal sent from the PC to effect the operation of the controlled system.
<b>Control System</b>	All of the hardware and software components used to control other devices. A Control System includes the PC System, the PC programs, and all I/O devices that are used to control or obtain feedback from the controlled system.
<b>controlled system</b>	The devices that are being controlled by a PC System.
<b>count pulse</b>	The signal counted by a counter.
<b>counter</b>	A dedicated group of digits or words in memory used to count the number of times a specific process has occurred, or a location in memory accessed through a TIM/CNT bit and used to count the number of times the status of a bit or an execution condition has changed from OFF to ON.
<b>CPU Unit</b>	See <i>central processing unit</i> .
<b>CTS</b>	An acronym for clear-to-send, a signal used in communications between electronic devices to indicate that the receiver is ready to accept incoming data.
<b>CY</b>	See <i>Carry Flag</i> .
<b>cycle</b>	One unit of processing performed by the CPU Unit, including ladder program execution, peripheral servicing, I/O refreshing, etc.
<b>cycle time</b>	The time required to complete one cycle of CPU Unit processing.
<b>cyclic interrupt</b>	See <i>scheduled interrupt</i> .
<b>data area</b>	An area in the PC's memory that is designed to hold a specific type of data.
<b>data area boundary</b>	The highest address available within a data area. When designating an operand that requires multiple words, it is necessary to ensure that the highest address in the data area is not exceeded.
<b>data disk</b>	A floppy disk used to same user programs, DM area contents, comments, and other user data.
<b>data length</b>	In communications, the number of bits that is to be treated as one unit in data transmissions.

<b>data link</b>	An automatic data transmission operation that allows PCs or Units within PC to pass data back and forth via common data areas.
<b>data link area</b>	A common data area established through a data link.
<b>data movement instruction</b>	An instruction used to move data from one location in memory to another. The data in the original memory location is left unchanged.
<b>data sharing</b>	The process in which common data areas or common data words are created between two or more PCs.
<b>data trace</b>	A process in which changes in the contents of specific memory locations are recorded during program execution.
<b>data transfer</b>	Moving data from one memory location to another, either within the same device or between different devices connected via a communications line or network.
<b>debug</b>	A process by which a draft program is corrected until it operates as intended. Debugging includes both the removal of syntax errors, as well as the fine-tuning of timing and coordination of control operations.
<b>decimal</b>	A number system where numbers are expressed to the base 10. In a PC all data is ultimately stored in binary form, four binary bits are often used to represent one decimal digit, via a system called binary-coded decimal.
<b>decrement</b>	Decreasing a numeric value, usually by 1.
<b>default</b>	A value automatically set by the PC when the user does not specifically set another value. Many devices will assume such default conditions upon the application of power.
<b>definer</b>	A number used as an operand for an instruction but that serves to define the instruction itself, rather than the data on which the instruction is to operate. Definers include jump numbers, subroutine numbers, etc.
<b>destination</b>	The location where an instruction places the data on which it is operating, as opposed to the location from which data is taken for use in the instruction. The location from which data is taken is called the source.
<b>differentiated instruction</b>	An instruction that is executed only once each time its execution condition goes from OFF to ON. Non-differentiated instructions are executed for each scan as long as the execution condition stays ON.
<b>differentiation instruction</b>	An instruction used to ensure that the operand bit is never turned ON for more than one scan after the execution condition goes either from OFF to ON for a Differentiate Up instruction or from ON to OFF for a Differentiate Down instruction.
<b>digit</b>	A unit of storage in memory that consists of four bits.
<b>digit designator</b>	An operand that is used to designate the digit or digits of a word to be used by an instruction.
<b>DIN track</b>	A rail designed to fit into grooves on various devices to allow the devices to be quickly and easily mounted to it.
<b>DIP switch</b>	Dual in-line package switch, an array of pins in a signal package that is mounted to a circuit board and is used to set operating parameters.
<b>direct output</b>	A method in which program execution results are output immediately to eliminate the affects of the cycle time.
<b>distributed control</b>	A automation concept in which control of each portion of an automated system is located near the devices actually being controlled, i.e., control is decentralized

	and 'distributed' over the system. Distributed control is a concept basic to PC Systems.
<b>DM area</b>	A data area used to hold only word data. Words in the DM area cannot be accessed bit by bit.
<b>DM word</b>	A word in the DM area.
<b>downloading</b>	The process of transferring a program or data from a higher-level or host computer to a lower-level or slave computer. If a Programming Device is involved, the Programming Device is considered the host computer.
<b>EEPROM</b>	Electrically erasable programmable read-only memory; a type of ROM in which stored data can be erased and reprogrammed. This is accomplished using a special control lead connected to the EEPROM chip and can be done without having to remove the EEPROM chip from the device in which it is mounted.
<b>electrical noise</b>	Random variations of one or more electrical characteristics such as voltage, current, and data, which might interfere with the normal operation of a device.
<b>EPROM</b>	Erasable programmable read-only memory; a type of ROM in which stored data can be erased, by ultraviolet light or other means, and reprogrammed.
<b>error code</b>	A numeric code generated to indicate that an error exists, and something about the nature of the error. Some error codes are generated by the system; others are defined in the program by the operator.
<b>Error Log Area</b>	An area used to store records indicating the time and nature of errors that have occurred in the system.
<b>even parity</b>	A communication setting that adjusts the number of ON bits so that it is always even. See <i>parity</i> .
<b>event processing</b>	Processing that is performed in response to an event, e.g., an interrupt signal.
<b>exclusive NOR</b>	A logic operation whereby the result is true if both of the premises are true or both of the premises are false. In ladder-diagram programming, the premises are usually the ON/OFF states of bits, or the logical combination of such states, called execution conditions.
<b>exclusive OR</b>	A logic operation whereby the result is true if one, and only one, of the premises is true. In ladder-diagram programming the premises are usually the ON/OFF states of bits, or the logical combination of such states, called execution conditions.
<b>execution condition</b>	The ON or OFF status under which an instruction is executed. The execution condition is determined by the logical combination of conditions on the same instruction line and up to the instruction currently being executed.
<b>execution cycle</b>	The cycle used to execute all processes required by the CPU Unit, including program execution, I/O refreshing, peripheral servicing, etc.
<b>execution time</b>	The time required for the CPU Unit to execute either an individual instruction or an entire program.
<b>extended counter</b>	A counter created in a program by using two or more count instructions in succession. Such a counter is capable of counting higher than any of the standard counters provided by the individual instructions.
<b>extended timer</b>	A timer created in a program by using two or more timers in succession. Such a timer is capable of timing longer than any of the standard timers provided by the individual instructions.

<b>FA</b>	Factory automation.
<b>factory computer</b>	A general-purpose computer, usually quite similar to a business computer, that is used in automated factory control.
<b>FAL error</b>	An error generated from the user program by execution of an FAL(06) instruction.
<b>FALS error</b>	An error generated from the user program by execution of an FALS(07) instruction or an error generated by the system.
<b>fatal error</b>	An error that stops PC operation and requires correction before operation can continue.
<b>FCS</b>	See <i>frame checksum</i> .
<b>flag</b>	A dedicated bit in memory that is set by the system to indicate some type of operating status. Some flags, such as the carry flag, can also be set by the operator or via the program.
<b>flicker bit</b>	A bit that is programmed to turn ON and OFF at a specific frequency.
<b>floating-point decimal</b>	A decimal number expressed as a number (the mantissa) multiplied by a power of 10, e.g., $0.538 \times 10^{-5}$ .
<b>force reset</b>	The process of forcibly turning OFF a bit via a programming device. Bits are usually turned OFF as a result of program execution.
<b>force set</b>	The process of forcibly turning ON a bit via a programming device. Bits are usually turned ON as a result of program execution.
<b>forced status</b>	The status of bits that have been force reset or force set.
<b>frame checksum</b>	The results of exclusive ORing all data within a specified calculation range. The frame checksum can be calculated on both the sending and receiving end of a data transfer to confirm that data was transmitted correctly.
<b>function code</b>	A two-digit number used to input an instruction into the PC.
<b>hardware error</b>	An error originating in the hardware structure (electronic components) of the PC, as opposed to a software error, which originates in software (i.e., programs).
<b>header code</b>	A code in an instruction that specifies what the instruction is to do.
<b>hexadecimal</b>	A number system where all numbers are expressed to the base 16. In a PC all data is ultimately stored in binary form, however, displays and inputs on Programming Devices are often expressed in hexadecimal to simplify operation. Each group of four binary bits is numerically equivalent to one hexadecimal digit.
<b>host computer</b>	A computer that is used to transfer data to or receive data from a PC in a Host Link system. The host computer is used for data management and overall system control. Host computers are generally small personal or business computers.
<b>host interface</b>	An interface that allows communications with a host computer.
<b>host link</b>	An interface connecting a PC to a host computer to enable monitoring or program control from the host computer.
<b>HR area</b>	A memory area that preserves bit status during power interrupts and used as work bits in programming.
<b>I/O bit</b>	A bit in memory used to hold I/O status. Input bits reflect the status of input terminals; output bits hold the status for output terminals.

<b>I/O capacity</b>	The number of inputs and outputs that a PC is able to handle. This number ranges from around one hundred for smaller PCs to two thousand for the largest ones.
<b>I/O delay</b>	The delay in time from when a signal is sent to an output to when the status of the output is actually in effect or the delay in time from when the status of an input changes until the signal indicating the change in the status is received.
<b>I/O device</b>	A device connected to the I/O terminals on I/O Units. I/O devices may be either part of the Control System, if they function to help control other devices, or they may be part of the controlled system.
<b>I/O interrupt</b>	An interrupt generated by a signal from I/O.
<b>I/O point</b>	The place at which an input signal enters the PC System, or at which an output signal leaves the PC System. In physical terms, I/O points correspond to terminals or connector pins on a Unit; in terms of programming, an I/O points correspond to I/O bits in the IR area.
<b>I/O refreshing</b>	The process of updating output status sent to external devices so that it agrees with the status of output bits held in memory and of updating input bits in memory so that they agree with the status of inputs from external devices.
<b>I/O response time</b>	The time required for an output signal to be sent from the PC in response to an input signal received from an external device.
<b>I/O Unit</b>	The Units in a PC that are physically connected to I/O devices to input and output signals. I/O Units include Input Units and Output Units, each of which is available in a range of specifications.
<b>I/O word</b>	A word in the IR area that is allocated to a Unit in the PC System and is used to hold I/O status for that Unit.
<b>IBM PC/AT or compatible</b>	A computer that has similar architecture to, that is logically compatible with, and that can run software designed for an IBM PC/AT computer.
<b>increment</b>	Increasing a numeric value, usually by 1.
<b>indirect address</b>	An address whose contents indicates another address. The contents of the second address will be used as the actual operand.
<b>initialization error</b>	An error that occurs either in hardware or software during the PC System startup, i.e., during initialization.
<b>initialize</b>	Part of the startup process whereby some memory areas are cleared, system setup is checked, and default values are set.
<b>input</b>	The signal coming from an external device into the PC. The term input is often used abstractly or collectively to refer to incoming signals.
<b>input bit</b>	A bit in the IR area that is allocated to hold the status of an input.
<b>input device</b>	An external device that sends signals into the PC System.
<b>input point</b>	The point at which an input enters the PC System. Input points correspond physically to terminals or connector pins.
<b>input signal</b>	A change in the status of a connection entering the PC. Generally an input signal is said to exist when, for example, a connection point goes from low to high voltage or from a nonconductive to a conductive state.
<b>install</b>	The preparation necessary to use a program or software package, such as the LSS or SSS, on a computer.

<b>instruction</b>	A direction given in the program that tells the PC of the action to be carried out, and the data to be used in carrying out the action. Instructions can be used to simply turn a bit ON or OFF, or they can perform much more complex actions, such as converting and/or transferring large blocks of data.
<b>instruction block</b>	A group of instructions that is logically related in a ladder-diagram program. A logic block includes all of the instruction lines that interconnect with each other from one or more line connecting to the left bus bar to one or more right-hand instructions connecting to the right bus bar.
<b>instruction execution time</b>	The time required to execute an instruction. The execution time for any one instruction can vary with the execution conditions for the instruction and the operands used in it.
<b>instruction line</b>	A group of conditions that lie together on the same horizontal line of a ladder diagram. Instruction lines can branch apart or join together to form instruction blocks. Also called a rung.
<b>interface</b>	An interface is the conceptual boundary between systems or devices and usually involves changes in the way the communicated data is represented. Interface devices perform operations like changing the coding, format, or speed of the data.
<b>interlock</b>	A programming method used to treat a number of instructions as a group so that the entire group can be reset together when individual execution is not required. An interlocked program section is executed normally for an ON execution condition and partially reset for an OFF execution condition.
<b>interrupt (signal)</b>	A signal that stops normal program execution and causes a subroutine to be run or other processing to take place.
<b>interrupt program</b>	A program that is executed in response to an interrupt.
<b>inverse condition</b>	See <i>normally closed condition</i> .
<b>JIS</b>	An acronym for Japanese Industrial Standards.
<b>jump</b>	A type of programming where execution moves directly from one point in a program to another, without sequentially executing any instructions in between.
<b>jump number</b>	A definer used with a jump that defines the points from and to which a jump is to be made.
<b>ladder diagram (program)</b>	A form of program arising out of relay-based control systems that uses circuit-type diagrams to represent the logic flow of programming instructions. The appearance of the program is similar to a ladder, and thus the name.
<b>ladder diagram symbol</b>	A symbol used in drawing a ladder-diagram program.
<b>ladder instruction</b>	An instruction that represents the conditions on a ladder-diagram program. The other instructions in a ladder diagram fall along the right side of the diagram and are called terminal instructions.
<b>Ladder Support Software</b>	A software package installed on a IBM PC/AT or compatible computer to function as a Programming Device.
<b>least-significant (bit/word)</b>	See <i>rightmost (bit/word)</i> .
<b>LED</b>	Acronym for light-emitting diode; a device used as for indicators or displays.
<b>leftmost (bit/word)</b>	The highest numbered bits of a group of bits, generally of an entire word, or the highest numbered words of a group of words. These bits/words are often called most-significant bits/words.



<b>link</b>	A hardware or software connection formed between two Units. "Link" can refer either to a part of the physical connection between two Units or a software connection created to data existing at another location (i.e., data links).
<b>load</b>	The processes of copying data either from an external device or from a storage area to an active portion of the system such as a display buffer. Also, an output device connected to the PC is called a load.
<b>logic block</b>	A group of instructions that is logically related in a ladder-diagram program and that requires logic block instructions to relate it to other instructions or logic blocks.
<b>logic block instruction</b>	An instruction used to locally combine the execution condition resulting from a logic block with a current execution condition. The current execution condition could be the result of a single condition, or of another logic block. AND Load and OR Load are the two logic block instructions.
<b>logic instruction</b>	Instructions used to logically combine the content of two words and output the logical results to a specified result word. The logic instructions combine all the same-numbered bits in the two words and output the result to the bit of the same number in the specified result word.
<b>LR area</b>	A data area that is used in data links.
<b>LSS</b>	See <i>Ladder Support Software</i> .
<b>main program</b>	All of a program except for subroutine and interrupt programs.
<b>mark trace</b>	A process in which changes in the contents of specific memory locations are recorded during program execution.
<b>masked bit</b>	A bit whose status has been temporarily made ineffective.
<b>masking</b>	'Covering' an interrupt signal so that the interrupt is not effective until the mask is removed.
<b>megabyte</b>	A unit of storage equal to one million bytes.
<b>memory area</b>	Any of the areas in the PC used to hold data or programs.
<b>message number</b>	A number assigned to a message generated with the MESSAGE instruction.
<b>mnemonic code</b>	A form of a ladder-diagram program that consists of a sequential list of the instructions without using a ladder diagram.
<b>MONITOR mode</b>	A mode of PC operation in which normal program execution is possible, and which allows modification of data held in memory. Used for monitoring or debugging the PC.
<b>most-significant (bit/word)</b>	See <i>leftmost (bit/word)</i> .
<b>NC input</b>	An input that is normally closed, i.e., the input signal is considered to be present when the circuit connected to the input opens.
<b>negative delay</b>	A delay set for a data trace in which recording data begins before the trace signal by a specified amount.
<b>nesting</b>	Programming one loop within another loop, programming a call to a subroutine within another subroutine, or programming one jump within another.
<b>NO input</b>	An input that is normally open, i.e., the input signal is considered to be present when the circuit connected to the input closes.
<b>noise interference</b>	Disturbances in signals caused by electrical noise.

<b>non-fatal error</b>	A hardware or software error that produces a warning but does not stop the PC from operating.
<b>normal condition</b>	See <i>normally open condition</i> .
<b>normally closed condition</b>	A condition that produces an ON execution condition when the bit assigned to it is OFF, and an OFF execution condition when the bit assigned to it is ON.
<b>normally open condition</b>	A condition that produces an ON execution condition when the bit assigned to it is ON, and an OFF execution condition when the bit assigned to it is OFF.
<b>NOT</b>	A logic operation which inverts the status of the operand. For example, AND NOT indicates an AND operation with the opposite of the actual status of the operand bit.
<b>OFF</b>	The status of an input or output when a signal is said not to be present. The OFF state is generally represented by a low voltage or by non-conductivity, but can be defined as the opposite of either.
<b>OFF delay</b>	The delay between the time when a signal is switched OFF (e.g., by an input device or PC) and the time when the signal reaches a state readable as an OFF signal (i.e., as no signal) by a receiving party (e.g., output device or PC).
<b>offset</b>	A positive or negative value added to a base value such as an address to specify a desired value.
<b>ON</b>	The status of an input or output when a signal is said to be present. The ON state is generally represented by a high voltage or by conductivity, but can be defined as the opposite of either.
<b>ON delay</b>	The delay between the time when an ON signal is initiated (e.g., by an input device or PC) and the time when the signal reaches a state readable as an ON signal by a receiving party (e.g., output device or PC).
<b>one-shot bit</b>	A bit that is turned ON or OFF for a specified interval of time which is longer than one scan.
<b>one-to-one link</b>	See <i>1:1 link</i> .
<b>online edit</b>	The process of changed the program directly in the PC from a Programming Device. Online editing is possible in PROGRAM or MONITOR mode. In MONITOR mode, the program can actually be changed while it is being
<b>operand</b>	The values designated as the data to be used for an instruction. An operand can be input as a constant expressing the actual numeric value to be used or as an address to express the location in memory of the data to be used.
<b>operand bit</b>	A bit designated as an operand for an instruction.
<b>operand word</b>	A word designated as an operand for an instruction.
<b>operating modes</b>	One of three PC modes: <i>PROGRAM mode</i> , <i>MONITOR mode</i> , and <i>RUN mode</i> .
<b>operating error</b>	An error that occurs during actual PC operation as opposed to an initialization error, which occurs before actual operations can begin.
<b>OR</b>	A logic operation whereby the result is true if either of two premises is true, or if both are true. In ladder-diagram programming the premises are usually ON/OFF states of bits or the logical combination of such states called execution conditions.
<b>output</b>	The signal sent from the PC to an external device. The term output is often used abstractly or collectively to refer to outgoing signals.

<b>output bit</b>	A bit in the IR area that is allocated to hold the status to be sent to an output device.
<b>output device</b>	An external device that receives signals from the PC System.
<b>output point</b>	The point at which an output leaves the PC System. Output points correspond physically to terminals or connector pins.
<b>output signal</b>	A signal being sent to an external device. Generally an output signal is said to exist when, for example, a connection point goes from low to high voltage or from a nonconductive to a conductive state.
<b>overflow</b>	The state where the capacity of a data storage location has been exceeded.
<b>overseeing</b>	Part of the processing performed by the CPU Unit that includes general tasks required to operate the PC.
<b>overwrite</b>	Changing the content of a memory location so that the previous content is lost.
<b>parity</b>	Adjustment of the number of ON bits in a word or other unit of data so that the total is always an even number or always an odd number. Parity is generally used to check the accuracy of data after being transmitted by confirming that the number of ON bits is still even or still odd.
<b>parity check</b>	Checking parity to ensure that transmitted data has not been corrupted.
<b>PC</b>	See <i>Programmable Controller</i> .
<b>PC configuration</b>	The arrangement and interconnections of the Units that are put together to form a functional PC.
<b>PC System</b>	With building-block PCs, all of the Units connected up to, but not including, the I/O devices. The boundaries of a PC System are the PC and the program in its CPU Unit at the upper end; and the I/O Units at the lower end.
<b>PCB</b>	See <i>printed circuit board</i> .
<b>PC Setup</b>	A group of operating parameters set in the PC from a Programming Device to control PC operation.
<b>Peripheral Device</b>	Devices connected to a PC System to aid in system operation. Peripheral devices include printers, programming devices, external storage media, etc.
<b>peripheral servicing</b>	Processing signals to and from peripheral devices, including refreshing, communications processing, interrupts, etc.
<b>port</b>	A connector on a PC or computer that serves as a connection to an external device.
<b>positive delay</b>	A delay set for a data trace in which recording data begins after the trace signal by a specified amount.
<b>Power Supply Unit</b>	A Unit that connected to a PC that provides power at the voltage required by the other Units.
<b>present value</b>	The current value registered in a device at any instant during its operation. Present value is abbreviated as PV. The use of this term is generally restricted to timers and counters.
<b>printed circuit board</b>	A board onto which electrical circuits are printed for mounting into a computer or electrical device.
<b>PROGRAM mode</b>	A mode of operation that allows inputting and debugging of programs to be carried out, but that does not permit normal execution of the program.

<b>Programmable Controller</b>	A computerized device that can accept inputs from external devices and generate outputs to external devices according to a program held in memory. Programmable Controllers are used to automate control of external devices. Although single-unit Programmable Controllers are available, building-block Programmable Controllers are constructed from separate components. Such Programmable Controllers are formed only when enough of these separate components are assembled to form a functional assembly.
<b>programmed alarm</b>	An alarm given as a result of execution of an instruction designed to generate the alarm in the program, as opposed to one generated by the system.
<b>programmed error</b>	An error arising as a result of the execution of an instruction designed to generate the error in the program, as opposed to one generated by the system.
<b>programmed message</b>	A message generated as a result of execution of an instruction designed to generate the message in the program, as opposed to one generated by the system.
<b>Programming Console</b>	The portable form of Programming Device for a PC.
<b>Programming Device</b>	A Peripheral Device used to input a program into a PC or to alter or monitor a program already held in the PC. There are dedicated programming devices, such as Programming Consoles, and there are non-dedicated devices, such as a host computer.
<b>PROM</b>	Programmable read-only memory; a type of ROM into which the program or data may be written after manufacture, by a customer, but which is fixed from that time on.
<b>prompt</b>	A message or symbol that appears on a display to request input from the operator.
<b>protocol</b>	The parameters and procedures that are standardized to enable two devices to communicate or to enable a programmer or operator to communicate with a device.
<b>PV</b>	See <i>present value</i> .
<b>RAM</b>	Random access memory; a data storage media. RAM will not retain data when power is disconnected.
<b>RAS</b>	An acronym for reliability, assurance, safety.
<b>read-only area</b>	A memory area from which the user can read status but to which data cannot be written.
<b>refresh</b>	The process of updating output status sent to external devices so that it agrees with the status of output bits held in memory and of updating input bits in memory so that they agree with the status of inputs from external devices.
<b>relay-based control</b>	The forerunner of PCs. In relay-based control, groups of relays are interconnected to form control circuits. In a PC, these are replaced by programmable circuits.
<b>reserved bit</b>	A bit that is not available for user application.
<b>reserved word</b>	A word in memory that is reserved for a special purpose and cannot be accessed by the user.
<b>reset</b>	The process of turning a bit or signal OFF or of changing the present value of a timer or counter to its set value or to zero.
<b>response code</b>	A code sent with the response to a data transmission that specifies how the transmitted data was processed.

<b>response format</b>	A format specifying the data required in a response to a data transmission.
<b>response monitoring time</b>	The time a device will wait for a response to a data transmission before assuming that an error has occurred.
<b>Restart Bit</b>	A bit used to restart part of a PC.
<b>result word</b>	A word used to hold the results from the execution of an instruction.
<b>retrieve</b>	The processes of copying data either from an external device or from a storage area to an active portion of the system such as a display buffer. Also, an output device connected to the PC is called a load.
<b>retry</b>	The process whereby a device will re-transmit data which has resulted in an error message from the receiving device.
<b>return</b>	The process by which instruction execution shifts from a subroutine back to the main program (usually the point from which the subroutine was called).
<b>reversible counter</b>	A counter that can be both incremented and decremented depending on the specified conditions.
<b>reversible shift register</b>	A shift register that can shift data in either direction depending on the specified conditions.
<b>right-hand instruction</b>	See <i>terminal instruction</i> .
<b>rightmost (bit/word)</b>	The lowest numbered bits of a group of bits, generally of an entire word, or the lowest numbered words of a group of words. These bits/words are often called least-significant bits/words.
<b>rising edge</b>	The point where a signal actually changes from an OFF to an ON status.
<b>ROM</b>	Read only memory; a type of digital storage that cannot be written to. A ROM chip is manufactured with its program or data already stored in it and can never be changed. However, the program or data can be read as many times as desired.
<b>rotate register</b>	A shift register in which the data moved out from one end is placed back into the shift register at the other end.
<b>RS-232C interface</b>	An industry standard for serial communications.
<b>RUN mode</b>	The operating mode used by the PC for normal control operations.
<b>rung</b>	See <i>instruction line</i> .
<b>scan</b>	The process used to execute a ladder-diagram program. The program is examined sequentially from start to finish and each instruction is executed in turn based on execution conditions.
<b>scan time</b>	See <i>cycle time</i> .
<b>scheduled interrupt</b>	An interrupt that is automatically generated by the system at a specific time or program location specified by the operator. Scheduled interrupts result in the execution of specific subroutines that can be used for instructions that must be executed repeatedly at a specified interval of time.
<b>SCP</b>	See <i>subtract count input</i> .
<b>seal</b>	See <i>self-maintaining bit</i> .
<b>self diagnosis</b>	A process whereby the system checks its own operation and generates a warning or error if an abnormality is discovered.

<b>self-maintaining bit</b>	A bit that is programmed to maintain either an OFF or ON status until set or reset by specified conditions.
<b>series</b>	A wiring method in which Units are wired consecutively in a string.
<b>servicing</b>	The process whereby the PC checks a connector or Unit to see if special processing is required.
<b>set</b>	The process of turning a bit or signal ON.
<b>set value</b>	The value from which a decrementing counter starts counting down or to which an incrementing counter counts up (i.e., the maximum count), or the time from which or for which a timer starts timing. Set value is abbreviated SV.
<b>shift input signal</b>	An input signal whose OFF to ON transition causes data to be shifted one bit.
<b>shift register</b>	One or more words in which data is shifted a specified number of units to the right or left in bit, digit, or word units. In a rotate register, data shifted out one end is shifted back into the other end. In other shift registers, new data (either specified data, zero(s) or one(s)) is shifted into one end and the data shifted out at the other end is lost.
<b>signed binary</b>	A binary value that is stored in memory along with a bit that indicates whether the value is positive or negative.
<b>signed decimal</b>	One-word signed hexadecimal values stored in the two's complement format can be displayed at the Programming Console as decimal values from -32,768 to 32,767.
<b>software error</b>	An error that originates in a software program.
<b>software protect</b>	A means of protecting data from being changed that uses software as opposed to a physical switch or other hardware setting.
<b>source (word)</b>	The location from which data is taken for use in an instruction, as opposed to the location to which the result of an instruction is to be written. The latter is called the destination.
<b>special instruction</b>	An instruction input with a function code that handles data processing operations within ladder diagrams, as opposed to a basic instruction, which makes up the fundamental portion of a ladder diagram.
<b>SR area</b>	A memory area containing flags and other bits/words with specific functions.
<b>SSS</b>	See <i>SYSMAC Support Software</i> .
<b>store</b>	The process of recording a program written into a display buffer permanently in memory.
<b>subroutine</b>	A group of instructions placed separate from the main program and executed only when called from the main program or activated by an interrupt.
<b>subroutine number</b>	A definer used to identify the subroutine that a subroutine call or interrupt activates.
<b>subtract count input</b>	An input signal used to decrement a counter when the signal changes from OFF to ON.
<b>SV</b>	See <i>set value</i> .
<b>switching capacity</b>	The maximum voltage/current that a relay can safely switch on and off.
<b>synchronous execution</b>	Execution of programs and servicing operations in which program execution and servicing are synchronized so that all servicing operations are executed each time the programs are executed.

<b>syntax</b>	The form of a program statement (as opposed to its meaning).
<b>syntax error</b>	An error in the way in which a program is written. Syntax errors can include 'spelling' mistakes (i.e., a function code that does not exist), mistakes in specifying operands within acceptable parameters (e.g., specifying read-only bits as a destination), and mistakes in actual application of instructions (e.g., a call to a subroutine that does not exist).
<b>SYSMAC Support Software</b>	A software package installed on a IBM PC/AT or compatible computer to function as a Programming Device.
<b>system configuration</b>	The arrangement in which Units in a System are connected. This term refers to the conceptual arrangement and wiring together of all the devices needed to comprise the System.
<b>system error</b>	An error generated by the system, as opposed to one resulting from execution of an instruction designed to generate an error.
<b>system error message</b>	An error message generated by the system, as opposed to one resulting from execution of an instruction designed to generate a message.
<b>system setup</b>	Operating environment settings for a Programming Device, e.g., the LSS or SSS.
<b>terminal instruction</b>	An instruction placed on the right side of a ladder diagram that uses the final execution conditions of an instruction line.
<b>timer</b>	A location in memory accessed through a TIM/CNT bit and used to time down from the timer's set value. Timers are turned ON and reset according to their execution conditions.
<b>TR area</b>	A data area used to store execution conditions so that they can be reloaded later for use with other instructions.
<b>TR bit</b>	A bit in the TR area.
<b>trace</b>	An operation whereby the program is executed and the resulting data is stored to enable step-by-step analysis and debugging.
<b>trace memory</b>	A memory area used to store the results of trace operations.
<b>transfer</b>	The process of moving data from one location to another within the PC, or between the PC and external devices. When data is transferred, generally a copy of the data is sent to the destination, i.e., the content of the source of the transfer is not changed.
<b>transmission distance</b>	The distance that a signal can be transmitted.
<b>trigger</b>	A signal used to activate some process, e.g., the execution of a trace operation.
<b>trigger address</b>	An address in the program that defines the beginning point for tracing. The actual beginning point can be altered from the trigger by defining either a positive or negative delay.
<b>UM area</b>	The memory area used to hold the active program, i.e., the program that is being currently executed.
<b>Unit</b>	In OMRON PC terminology, the word Unit is capitalized to indicate any product sold for a PC System. Most of the names of these products end with the word Unit.
<b>unit number</b>	A number assigned to some Units to facilitate identification when assigning words or other operating parameters.

<b>unmasked bit</b>	A bit whose status is effective. See <i>masked bit</i> .
<b>unsigned binary</b>	A binary value that is stored in memory without any indication of whether it is positive or negative.
<b>unsigned decimal</b>	One-word hexadecimal values can be displayed at the Programming Console as decimal values from 0 to 65,535.
<b>uploading</b>	The process of transferring a program or data from a lower-level or slave computer to a higher-level or host computer. If a Programming Device is involved, the Programming Device is considered the host computer.
<b>watchdog timer</b>	A timer within the system that ensures that the scan time stays within specified limits. When limits are reached, either warnings are given or PC operation is stopped depending on the particular limit that is reached.
<b>WDT</b>	See <i>watchdog timer</i> .
<b>word</b>	A unit of data storage in memory that consists of 16 bits. All data areas consists of words. Some data areas can be accessed only by words; others, by either words or bits.
<b>word address</b>	The location in memory where a word of data is stored. A word address must specify (sometimes by default) the data area and the number of the word that is being addressed.
<b>work area</b>	A part of memory containing work words/bits.
<b>work bit</b>	A bit in a work word.
<b>work word</b>	A word that can be used for data calculation or other manipulation in programming, i.e., a 'work space' in memory. A large portion of the IR area is always reserved for work words. Parts of other areas not required for special purposes may also be used as work words.
<b>write protect switch</b>	A switch used to write-protect the contents of a storage device, e.g., a floppy disk. If the hole on the upper left of a floppy disk is open, the information on this floppy disk cannot be altered.
<b>write-protect</b>	A state in which the contents of a storage device can be read but cannot be altered.



# Index

## Numbers

- 1-to-1 communications, 9, 42
- 1-to-n communications, 10, 43

## A

- Adapters, list of communications adapters, 10
- analog setting function, 3, 4
- analog volume controls, 4
  - location, 24
- arc killer, examples, 41
- ASCII, converting displays, Programming Console, 78

## B

- binary data, modifying, Programming Console, 75
- bit status, force-set/reset, Programming Console, 77
- bits, searching, Programming Console, 63
- buzzer operation, Programming Console, 61

## C

- cabinet
  - installation, precautions, 30
  - Programming Console installation, 56
- characteristics, 17
- check levels, program checks, 91
- checking, program syntax, Programming Console, 68
- circuit configuration
  - inputs, 19
  - outputs, 21
- clearing, memory areas, Programming Console, 60
- communication errors, 89
- communications, adapters, list, 10
- communications adapters, standard models, 103
- communications baud rate, for SSS, 48
- components
  - Communication Adapters, 26
  - CPU Unit, 22
  - Expansion I/O Unit, 25
- computer
  - 1-to-1 communications, 9
  - 1-to-n communications, 10
  - connecting, 42
- conduit installation, 34

- configuration, 8
- Counter Mode, 5
- countermeasures, EMC Directives, 40
- counters
  - changing SV, Programming Console, 73
  - example of inputting, 82
- CPM1 installation, 31
- CPU Units, standard models, 103
- cycle, CPM1 operating cycle, 88
- cycle time
  - displaying, Programming Console, 78
  - processing, 88

## D

- data, modifying, Programming Console, 72–73, 74, 75, 76
- data link, 11, 45
- decimal data with sign. *See* signed decimal data
- decimal data without sign. *See* unsigned decimal data
- differentiated instructions, entering, 66
- dimensions, 105
- DIN Track installation, 32
- displays
  - converting between hex and ASCII, Programming Console, 78
  - cycle time, Programming Console, 78
- duct installation, 34

## E

- electrical noise, preventing, 30, 34
- EMC Directives, countermeasures, 40
- ERR/ALM indicator
  - flashing, 89
  - lit, 89
- errors
  - communications, 89
  - error processing, 85
  - fatal, 89
  - identifying, 90
  - non-fatal, 89
  - programming, 91
  - Programming Console operations, 91
  - reading/clearing messages, Programming Console, 61
  - user-defined errors, 90
- Expansion I/O Units
  - connection, 33
  - standard models, 103

## F

- FAL numbers, 89

FAL(06), 90  
FALS numbers, 89  
FALS(07), 91  
false inputs, 38  
fatal errors, troubleshooting, 95  
features, CPM1 features, 2  
filter function, 2  
flash memory, precautions, 87  
flicker output, example, 83  
force-set/reset  
  clearing, Programming Console, 77  
  Programming Console, 77  
functions, CPM1 functions, 4

## G–H

grounding, 16, 23  
hexadecimal data, converting displays, Programming Console, 78  
high-speed counter, 3, 7  
Host Link  
  communications, 9  
  connections, 42

## I

I/O errors, troubleshooting, 97  
I/O line noise, preventing, 34  
I/O terminals, IR bit allocation, 3  
incremental mode, 7  
indicators  
  flashing ERR/ALM indicator, 89  
  lit ERR/ALM indicator, 89  
  PC status indicators, 24  
inductive loads, 38, 39  
initialization processes, 88  
input devices, connecting, 37  
input filter function, 4  
input interrupts, 2, 5  
input specifications, 19  
input time constant, 4  
inputs, wiring, 36  
inspections, 101  
installation  
  CPM1 installation, 31  
  site, selecting, 29

instructions  
  inserting and deleting, Programming Console, 63  
  searching, Programming Console, 62  
interlock circuit, example, 28  
interrupt inputs, 2, 5  
Interrupt Mode, 5  
interval timer, 2, 6  
IR bit allocation, 3

## L

leakage current, 38  
limit circuit, 28  
limit switches, preventing false inputs, 38

## M

maintenance, 101  
memory  
  backup, 2, 17  
  protection, 17  
memory areas  
  clearing, Programming Console, 60  
  partial clear, 60  
messages, reading/clearing, 61  
mode, changing the PC mode, 58  
Mode Setting Switch, RS-232C Adapter, 26  
modifying  
  binary data, Programming Console, 75  
  data, Programming Console, 72  
  hexadecimal/BCD data, Programming Console, 74  
  signed decimal data, Programming Console, 75  
  SV, Programming Console, 73  
  unsigned decimal data, Programming Console, 76  
MONITOR mode  
  description, 58  
  example test run, 84  
monitoring  
  3-word monitor, Programming Console, 71  
  binary monitor, Programming Console, 70–71  
  differentiation monitor, Programming Console, 70  
  signed decimal monitor, Programming Console, 72  
  status, Programming Console, 68  
  unsigned decimal monitor, Programming Console, 72  
MSG(46), 91

## N

noise, preventing electrical noise, 30, 34  
non-fatal errors, troubleshooting, 96  
NPN current output, connecting, 37  
NPN open collector, connecting, 37

## NT Link

- communications, 12
- connections, 46

**O**

- one-shot mode, 6
- operating conditions, troubleshooting, 99
- operation, preparations, 57
- operations, internal processing, flowchart, 88
- output short protection, 39
- output specifications, 21
- output wiring, 38
- overseeing processes, 88

**P**

- panel, Programming Console installation, 56
- panel installation, precautions, 30
- password, entering on Programming Console, 57
- PC mode, changing, 58
- PC Status, indicators, 24
- Peripheral Devices, 104
  - connecting, 12, 42
  - using, 47
- photoelectric switches, preventing false inputs, 38
- PNP current output, connecting, 37
- power, consumption, 16
- power cables, 34
- power interruptions, CPM1, 28
- power supply
  - capacity, 16
  - troubleshooting, 94, 100
  - wiring, 35
- precautions
  - design precautions, 28
  - general, xi
  - handling, 102
  - SSS, 48
- program, programming example, 78
- program capacity, 17
- program memory, setting address and reading content, Programming Console, 62
- PROGRAM mode, description, 58
- Programmable Terminal
  - 1-to-1 communications, 9
  - connecting, 43

- programming
  - checking the program, 83–84
  - checks for syntax, Programming Console, 68
  - errors, 91
  - inserting and deleting instructions, Programming Console, 63–65
  - preparation for, 78
  - searching, Programming Console, 62–63
  - setting and reading a memory address, Programming Console, 62
- Programming Console
  - connecting, 12, 42, 56
  - keys, 55
  - models, 55
  - operations, 59
- programming example, 78
- programs
  - checking, check levels, 91
  - entering and editing, Programming Console, 65
- proximity switches, preventing false inputs, 38

**Q–R**

- quick-response inputs, 2, 6
- relay outputs, connecting, 37
- response time, for interrupt inputs, 5
- restrictions, SSS, 48
- RS-232C Adapter
  - components, 26
  - specifications, 21
- RS-422 Adapter
  - components, 26
  - specifications, 22
- RUN mode, description, 58

**S**

- scheduled interrupt mode, 6
- scheduled interrupts, 2, 6
- search
  - instruction, Programming Console, 62–63
  - operands, Programming Console, 63
- self-diagnosis functions, 17, 89
- self-holding bit, example, 81
- signed decimal data
  - modifying, Programming Console, 75
  - monitoring, 72
- specifications
  - changes, 14
  - characteristics, 17
  - Communications Adapters, 21
  - general specifications, 16
  - input specifications, 19
  - output specifications, 21

SSS, 48  
  offline and online operations, 54  
  offline operations, 49  
  online operations, 52  
  precautions, 48  
  restrictions, 48  
  System Setup, 48

status, monitoring, Programming Console, 68

SV, modifying, Programming Console, 73

syntax, checking the program, Programming Console, 68

SYSMAC Support Software, 13  
  *See also* SSS  
  connecting, 12

SYSMAC-CPT, 13

SYSMAC-CPT, 48

system  
  checks, 86  
  configuration, 8

System Setup, 48

## T

temperature  
  effect on capacitor backup, 18  
  operating, storage, 16

Termination Resistance Switch, RS-422 Adapter, 26

test run  
  example, 84  
  procedure, 86

timers  
  changing SV, Programming Console, 73  
  example of inputting, 82

troubleshooting, 93  
  fatal errors, 95  
  I/O errors, 97  
  non-fatal errors, 96  
  operating conditions, 99  
  power supply, 94, 100

## U–V

unsigned decimal data  
  modifying, Programming Console, 76  
  monitoring, 72

up/down mode, 7

voltage, supply voltage, 16

voltage output, connecting, 37

## W

weight  
  CPU Unit, 16  
  Expansion I/O Unit, 16

wiring, 34  
  power supply, 35

# Revision History

A manual revision code appears as a suffix to the catalog number on the front cover of the manual.

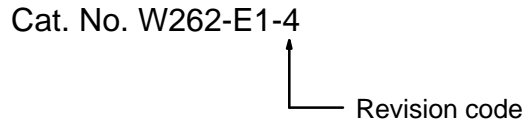

The following table outlines the changes made to the manual during each revision. Page numbers refer to the previous version.

Revision code	Date	Revised content
1	December 1995	Original production
2	March 1997	<p><i>Precautions</i> added in front of <i>Section 1</i>.</p> <p><b>Page ix:</b> <i>CPM1 Programming Manual</i> corrected to <i>CQM1/CPM1/CPM1A/SRM1 Programming Manual</i>. Reference to the <i>CPM1-series Dedicated I/O Units Operation Manual</i> was removed as this manual does not exist.</p> <p><b>Pages ix, 10, 87, 97:</b> References to the Ladder Support Software (LSS) removed.</p> <p><b>Page 3:</b> PT programming feature added.</p> <p><b>Page 4:</b> Top sentence corrected.</p> <p><b>Pages 4 to 6:</b> References to the Programming Manual added.</p> <p><b>Page 8:</b> Link Adapter model number corrected. "OMRON PCs" in <i>1-to-n Communications</i> corrected to "CPM1 PCs."</p> <p><b>Page 11:</b> Ladder Support Software information removed. Remaining information in table updated.</p> <p><b>Pages 11, 46:</b> SSS version information corrected to include all SSS versions.</p> <p><b>Page 14:</b> Shock resistance corrected.</p> <p><b>Page 15:</b> Input bits, output bits, work bits, and special bits corrected. Input interrupt and interval timer interrupt information added. Note added.</p> <p><b>Page 16:</b> <i>Backup Time vs. Temperature</i> rewritten.</p> <p><b>Pages 16, 17:</b> ON delay and OFF delay information corrected.</p> <p><b>Page 17:</b> Caution added to the table.</p> <p><b>Page 18:</b> Relay information removed. Caution added to the table.</p> <p><b>Page 20:</b> Power Supply output terminal description corrected.</p> <p><b>Page 22:</b> Expansion connector information removed.</p> <p><b>Page 23:</b> Notes added.</p> <p><b>Page 26:</b> <i>3-1-3 Power Supply Voltage</i> added.</p> <p><b>Page 27:</b> <i>3-2-1 Installation Site Conditions</i> added.</p> <p><b>Page 29:</b> Expansion I/O Unit removed from the top sentence.</p> <p><b>Page 31:</b> Caution added.</p> <p><b>Page 32:</b> Wire diameter in <i>Grounding</i> and <i>100 to 240 VAC Power Supply</i> and tightening torque in <i>Crimp Connectors</i> corrected. Cautions and note added.</p> <p><b>Pages 33, 34:</b> Input wiring diagrams corrected.</p> <p><b>Page 34:</b> "COM(+)" corrected to "COM(-)" for the PNP current output.</p> <p><b>Page 40:</b> Connection diagram corrected. "Other OMRON PCs" removed, only CPM1 PCs can be connected.</p> <p><b>Page 41:</b> Tightening torque corrected.</p> <p><b>Pages 42, 43:</b> Connection diagram corrected.</p> <p><b>Page 55:</b> Caution at the end of <i>4-2-3 Changing the CPM1's Mode</i> rewritten. <i>4-3-1 Overview</i> added.</p> <p><b>Page 56:</b> Caution added to the end of <i>4-3-2 Clearing Memory</i>. Fatal error information in the first paragraph of <i>4-3-3 Reading/Clearing Error Messages</i> corrected.</p> <p><b>Pages 69 to 73:</b> Cautions added.</p> <p><b>Page 74:</b> Minor correction to the PASSWORD display.</p> <p><b>Page 82:</b> Information and notes added to <i>5-1-1 Initial System Checks</i>.</p> <p><b>Pages 82, 83:</b> Information in <i>5-1-3 Flash Memory Precautions</i> replaced.</p> <p><b>Page 85:</b> Information for "Power interruption" corrected.</p> <p><b>Page 89:</b> Minor addition to the flowchart.</p> <p><b>Page 90:</b> "Replace the Power Supply Unit" corrected to "Replace the CPU Unit."</p> <p><b>Page 92:</b> Flowchart corrected.</p> <p><b>Page 95:</b> <i>5-7 Maintenance Inspections</i> and <i>5-8 Handling Precautions</i> added.</p> <p><b>Page 97:</b> Information added after the Communications Adapters table.</p>
3	July 1997	<p><b>Page 3:</b> Note on Expansion I/O Units added.</p> <p><b>Page 7:</b> Description added after the table for the CPM1 Expansion I/O Unit.</p> <p><b>Pages 12, 46, 101:</b> SYSMAC-CPT information added.</p> <p><b>Page 34:</b> Information and caution for <i>24-VDC Power Supply</i> rewritten.</p> <p><b>Page 101:</b> Expansion I/O Unit models added.</p>

## *Revision History*

Revision code	Date	Revised content
4	February 1998	<p><b>Pages xiii to xvi:</b> Cautions rewritten and corrected.</p> <p><b>Page 2:</b> I/O capacity information added to <i>Extra I/O Capacity</i>.</p> <p><b>Page 3:</b> New CPU Unit information added to the table.</p> <p><b>Page 4:</b> Information added to <i>Input Filter Function</i>.</p> <p><b>Pages 5, 14, 15, 21, 29, 37, 104:</b> “(-V1)” added to “CPM1-30CDR-□.”</p> <p><b>Pages 7, 101:</b> New CPU Unit information added to the CPU Units table.</p> <p><b>Page 7:</b> Expansion I/O Unit information added.</p> <p><b>Page 10:</b> RS-232C Adapter description at the top of the page changed.</p> <p><b>Page 12:</b> SYSMAC-CPT added in text.</p> <p><b>Page 13:</b> <i>1-3 Revised Specifications</i> added.</p> <p><b>Page 15:</b> Memory protection and memory backup specs changed.</p> <p><b>Page 16:</b> Entire page redone.</p> <p><b>Page 19:</b> Mechanical life of relay corrected in the top table.</p> <p><b>Page 22:</b> Input indicator description corrected.</p> <p><b>Page 23:</b> Caution added to 2-2-2 Expansion I/O Unit Components.</p> <p><b>Page 46:</b> Note and section on online editing added.</p> <p><b>Page 53:</b> Note on the Programming Consoles added.</p> <p><b>Page 55:</b> <i>4-2-3 Preparation for Operation</i> and <i>4-2-4 Entering the Password</i> sections added.</p> <p><b>Pages 57, 58, 65, 70, 76, 80:</b> Screen messages corrected.</p> <p><b>Page 77:</b> T001 in the ladder program corrected.</p> <p><b>Page 84:</b> Notes changed below table.</p> <p><b>Page 87:</b> AR 1309 corrected and AR 1314 added.</p> <p><b>Page 93:</b> Reference to Memory Error Check flowchart added.</p> <p><b>Page 97:</b> Memory Error Check flowchart added.</p> <p><b>Page 98:</b> Changed humidity</p>