

Preface

Thank you for purchasing Digital's Pro-face GP-470/570 Series of Graphic Control Panels (hereafter referred to as the *GP unit*).

These GP units, with its expanded user functionality and improved overall performance, are an upgrade of Digital's GP-*50 series panels.

Please read this manual carefully as it explains, step by step, how to use the GP correctly.

Also, in this manual's examples, the Mitsubishi MELSEC-AnA Series of PLC's is used whenever possible, connected in a one-to-one relationship with a GP.

GP-470 and GP-570 Series refers to the following GP model numbers:

GP-470 Series	GP470-EG11 (Standard unit)
	GP470-EG21-** (CE marked unit)
	GP470-EG31-** (cUL marked unit)
GP-570 Series	GP570-TC11, GP570-SC11 (Standard unit)
	GP570-TC21-**, GP570-SC21-** (CE marked unit)
	GP570-TC31-**, GP570-SC31-** (cUL marked unit)
	GP571-TC11 (64 color display unit)

<Note>

- 1) It is forbidden to copy the contents of this manual, in whole or in part, except for the user's personal use, without the express permission of the Digital Electronics Corporation of Japan
- 2) The information provided in this manual is subject to change without notice.
- 3) This manual has been written with care and attention to detail; however, should you find any errors or omissions, please contact Digital Electronics and inform them of your findings.
- 4) Please be aware that we are not responsible for any damages resulting from the use of our products, regardless of article 3 above.

The GP470-EG21-**, GP570-TC21-**, and GP570-SC21-** models are products jointly developed with Pro-face HMI B.V. in Europe. The front sheet designs for these models differ from the standard or cUL recognized models.

All Company/Manufacturer names used in this manual are the registered trademarks of those companies.

© Copyright July 1998, Digital Electronics Corporation

Table of Contents

Preface	i
Table of Contents	ii - iv
Cautions	v - vi
UL Application Notes	vii
Package Contents	viii
Symbol Information	ix

Chapter 1 - Introduction

1.1 Operating the GP	1-1
1.2 System Design	1-2
1.3 Optional Equipment.....	1-5

Chapter 2 - Specifications

2.1 General Specifications	2-1
1. Electrical Specifications	2-1
2. Environmental Specifications	2-2
3. Structural Specifications	2-2
2.2 Features and Performance	2-3
1. Display Features	2-3
2. Screen Memory	2-4
3. Touch Panel / Clock Accuracy	2-4
4. External Interfaces	2-5
2.3 Interface Specifications	2-6
1. Printer Interface	2-6
2. AUX I/F (Input/ Output)	2-7
3. Serial Interface	2-9
2.4 Names and Functions of GP Parts.....	2-10
2.5 Graphic Panel Dimensions	2-11
1. GP-470 Series External Dimensions	2-11
2. GP-570 Series External Dimensions	2-12
3. Installation Fasteners	2-13
4. GP Installation Mounting Hole Dimensions	2-14

Chapter 3 - Installation and Wiring

3.1 Installation	3-1
1. Creating an Installation Opening	3-1
2. Installation Direction	3-3
3. Securing the Installation Fasteners	3-3
4. Inserting and Tightening the Fasteners	3-4
3.2 Wiring Cautions	3-5
1. Connecting the GP's Power Cable	3-5
2. Connecting the GP Power Supply Terminals	3-6
3. Connecting the GP's Power Supply	3-7
4. Grounding the GP	3-8
5. Placement of I/O Signal Lines	3-9
3.3 Connecting the Printer Cable	3-9
3.4 GP Tool Connector	3-10

Chapter 4 - OFFLINE Mode

4.1 Entering OFFLINE Mode	4-1
1. When Turning the GP's Power ON	4-1
2. From Forced Reset	4-2
4.2 OFFLINE Mode's Main Menu	4-3
4.3 INITIALIZE - Standard Operation	4-4
4.4 SELF-DIAGNOSIS - Standard Operation	4-6
4.5 Transferring Screen Data	4-8

Chapter 5 - Initializing the GP

5.1 Initialization Screen	5-1
5.2 Initialization Items	5-2
5.3 SYSTEM ENVIRONMENT SETUP	5-3
1. SYSTEM SETUP	5-3
2. SYSTEM AREA SETUP	5-4
3. GLOBAL WINDOW SETUP	5-5
4. CHARACTER STRING DATA SETUP	5-6
5.4 SET UP I/O	5-9
1. SET UP SIO	5-9
2. SET UP PRINTER	5-10
3. SET UP TOUCH PANEL	5-11
4. COMMUNICATION SETUP	5-13
5.5 PLC SETUP	5-14
1. SET UP OPERATION SURROUNDINGS (1:1)	5-14
2. SET UP OPERATION SURROUNDINGS (n:1)	5-15
3. STATION SETUP (n:1)	5-16
4. CUSTOMIZE SETUP	5-18

5.6 INITIALIZE INTERNAL MEMORY	5-20
5.7 SET UP TIME	5-20
5.8 SET UP SCREEN	5-21

Chapter 6 - GP RUN and Errors

6.1 RUN MODE	6-1
1. After Powering Up The GP	6-1
2. Via OFFLINE Mode	6-1
6.2 Troubleshooting	6-2
1. Possible Types of Trouble	6-2
2. No Display	6-4
3. No GP/Host Communication	6-7
4. The Touch Panel Does Not Respond	6-9
6.3 GP SELF-DIAGNOSIS	6-10
1. SELF-DIAGNOSIS Menu	6-10
2. SELF-DIAGNOSIS - Details	6-11
6.4 Error Messages	6-14
1. Error Message List	6-14
2. Error Messages - Details	6-15

Chapter 7 - Maintenance

7.1 Regular Cleaning	7-1
1. Cleaning the Display	7-1
2. Installation Gasket Check/Replacement	7-1
7.2 Periodic Check-Up	7-3
7.3 Changing the Backlight	7-4

Index	i - ii
--------------------	---------------

Cautions

For safe and correct use of this unit, follow these guidelines.

- Because of the ever present danger of electric shocks, make sure the Power Cable is not plugged in when connecting it up to the GP.
- Whenever changing the Backlight, to prevent electric shocks or burns, be sure to turn off the GP power and use protective gloves.
- Because the GP is loaded with high voltage parts, electric shocks can occur when disassembling the unit. *Do not disassemble the GP.*
- Do not use power beyond the specified voltage range. If you do, it may cause a fire or an electric shock.
- Do not reconstruct the GP unit. It may cause a fire or an electric shock.
- Do not use the GP in an environment with flammable gas in the surrounding atmosphere. It may cause explosion.
- GP uses a lithium battery for backing up its internal clock data. If the battery is incorrectly replaced, the battery may explode. To avoid the danger, please do not replace the battery yourself. When the battery needs a replacement, please consult with your local GP distributor.
- Do not use touch panel *keys* in any life-related or important disaster prevention situations. Use separate hardware switches for such keys.
- Please design your system so that the machine will not malfunction by a communication fault between the GP and its host controller. If not, there could be a danger of injuring a person or damaging materials.

To Prevent GP Damage:

- Never strike the touch panel with a hard or heavy object, or push on the touch panel with too much force, since it may damage the unit.
- If the GP is used in an environment that has temperatures in excess of the allowed range, the GP may malfunction.
- Do not allow water, liquids, or metal particles to enter inside the GP's chassis, since they can cause either a GP malfunction or an electrical shocks.
- Avoid restricting the GP's naturally occurring ventilation, or storing or using the GP in an environment that is too hot.
- Avoid using or storing the GP in direct sunlight, or in excessively dusty or dirty

- Avoid using or storing the GP in direct sunlight, or in excessively dusty or dirty environments.
- Because the GP is a precision instrument, do not store or use the GP where powerful shocks or excessive vibration will occur.
- Do not store or use the GP where chemicals and acids evaporate, or where chemicals and acids are dispersed into the air.
- Do not use paint thinner or organic solvents to clean the GP.
- Be sure to back up all screen data regularly.
- After turning this unit OFF, be sure to wait a few seconds before turning it ON again. If the unit is started too soon, it may not start up correctly.

About the GP's Display Panel

- The Display Panel contents and the Contrast Adjustment affect the intensity of *Contouring*. (i.e, when some parts of the screen are brighter than others, creating a wavelike pattern)
- There are minute grid-points (dark/light) on the Display Panel's surface. This is part of the GP's design and not a defect.
- Shadows may appear at the top of the LCD. This is normal for an LCD display.
- Sometimes the display area may look as if the display colors have changed. This is a common attribute of LCD's and is not a defect.
- Displaying a single image for long periods can cause an afterimage to remain when the display is changed to another screen.

To prevent this effect:

- Set the unit to "Stand-by Mode", which turns the screen OFF automatically when there is no input (a single screen display with no operations) for a specified period of time.
- Do not display any single screen for a long period of time. Try to always change the screen display periodically.

UL/cUL Application Notes

The GP470-EG31-**, GP570-TC31-**, and the GP570-SC31-** are all UL1950 approved products. (UL file no. E171486) Please feel free to build them into your product. When applying for UL approval for a machine which includes one of these GP units, please be sure to pay special attention to the following instruction. Machinery with built-in GP units require UL inspection of the combination of the GP and the machinery.

- GP components conform to the following standards:

1950 (plus D3) Second Edition, dated February 26, 1993 (Standard for Safety of Information Technology Equipment, including Electrical Business Equipment)

CAN/CSA-C22.2 No. 950-M89 (plus D3) (Standard for Safety of Information Technology Equipment, including Electrical Business Equipment)

The D3 deviation items are: SC1.3.4, SC1.3.8, SC2.1, SC2.9, and SC5.3.

These deviations will lose their effect as of March 15, 2000.

GP470-EG31-** (UL Registration Model: 0680029-02) Class 1 Equipment

GP570-TC31-** (UL Registration Model: 0680035-03)

GP570-SC31-** (UL Registration Model: 0680035-04)

- Machinery which includes the GP device will also be treated as having the D3 deviations.
- The GP470-EG31-** power input terminal block's earth lead \oplus is a protective earth lead. This lead should be earthed in accordance with UL standards.
- The electric power must be supplied by an ELV circuit which complies with Subclause 1.3.8 in the UL 1950 standard, or by a limited power source which fulfills conditions of clause.
- If the GP is mounted so as to cool itself naturally, please mount it on a vertical panel. Also, insure that the GP is mounted at least 100mm away from any other adjacent structures or machine parts. If these conditions are not met, the heat generated by the GP's internal components may cause it to fail to meet UL standards.

CE Marking

The GP470-EG21-** and GP570-SC21-** models are CE marked products that conform to EMC Directive, EN55022 Class A and EN50082-2.

Package Contents

The GP's packing box contains the items listed below. Please check to confirm that all items shown below have been included.

- **GP Unit**

(Standard models)

GP470-EG11, GP570-TC11, GP570-SC11, GP571-TC11

(CE marked models)

GP470-EG21-**, GP570-TC21-**, GP570-SC21-**

(cUL marked models)

GP470-EG31-**, GP570-TC31-**, GP570-SC31-**

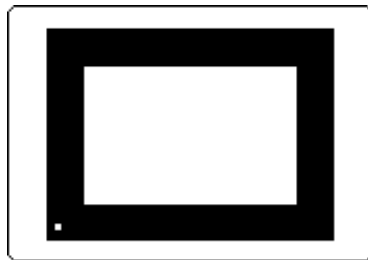

- **Operation Instructions (1)*1**

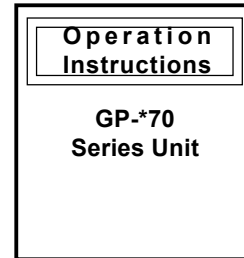

- **Installation fasteners (4/set)**



Note: If the GP is turned OFF while any Q tag generated alarm messages are still being displayed, only GP units equipped with backup SRAM will automatically backup the data. Whether a unit is equipped with this SRAM or not can be known by looking at the metallic seal on the rear face of the GP. If the seal is copper colored, the unit is equipped with SRAM; if it is silver colored, it is not.

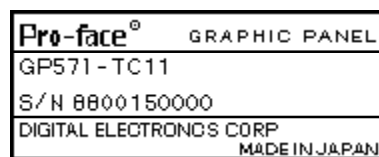





This unit has been carefully packed, with special attention to quality. However, should you find anything damaged or missing, please contact your local GP distributor immediately for prompt service.

*1 This manual (GP-470/570 Series User's Manual) is sold separately.

Symbol Information

The list below describes the symbols used in this manual.

Symbol	Meaning
 Warning	Indicates situations where severe bodily injury, death or major machine damage can occur.
 Caution	Indicates situations where slight bodily injury or machine damage can occur.
 Important	Indicates important information or procedures that <u>must</u> be followed for correct and risk-free software/device operation.
*1	Indicates useful or important supplemental information.
1) , 2)	Indicates steps in a procedure. Be sure to perform these steps in the order given.
Reference	Refers to useful or important supplemental information.
 Note:	Provides useful or important supplemental information.
GP Screen Editor	Indicates the GP-PRO/PBIII or GP-PRO/PBIII for Windows 95 screen editor software.
PLC	Abbreviation for Programmable Logic Controller.
n:1	Indicates a multi-link type of connection is used.

MEMO

Chapter 1

Introduction

1. Operating the GP
2. System Design
3. Optional Equipment

1.1 Operating the GP

Be sure to follow these steps when operating the GP unit.

- 1 Preparation**

Before using the GP, check that all required hardware is present and read all specification, wiring, and installation information.
Reference *Chapter 2, "Specifications", and Chapter 3, "Installation and Wiring"*
- 2 Screen Design**

Create a sample screen and design a Tag layout, with the Screen layout sheets and Tag lists provided in the Editor software.
Reference *GP-PRO/PBIII Operation Manual*
- 3 Select GP and PLC types**

Using the input areas provided, select the GP and the PLC types to be used.
Reference *GP-PRO/PBIII Operation Manual*
- 4 Create Screen/ Run Screen Setup**

Setup the screen and tags in your screen editing software according to your Screen Design.
Reference *GP-PRO/PBIII Operation Manual and Tag Reference Manual*
- 5 Transfer Screen Data**

Transfer the data from the Screen design software on your PC to the GP unit using the Downloading Cable.
Reference *GP-PRO/PBIII Operation Manual*
- 6 GP/Host Connection**

Set up the GP so that it can receive data from the Host (PLC).
Reference *Chapter 4, "Initialize", and PLC Connection Manual*
- 7 Operate the GP**



Link the GP with the host (PLC) using the Connection Cable (different cables may be necessary for different hosts), and then run the unit.
Reference *PLC Connection Manual*

1.2 System Design

The diagram on the following pages illustrates the peripheral equipment available for the GP unit.

Legend

GP Interfaces	PLC Interfaces	PC Interface
① Tool Connector	⑤ RS-232C Port	⑧ Printer Interface
② Serial Interface	⑥ RS-422 Port	
③ AUX Interface	⑦ Programming Port	
④ Printer Interface		

	Screen Editing Environment
	GP Operating Environment

Optional Parts



Cover (Protection) Sheet
 GP470-COVER-*0P (for GP-470 Series)
 GP570-COVER-*0P (for GP-570 Series)
 GP470-DF10-O (Hard type - for GP-470)
 GP570-DF10-O (Hard type - for GP-570)

Maintenance Parts



GP-570 Series Backlight Bulbs
 GP570-BL00-MS (for GP570-TC**, GP570-SC**, and GP571-TC**)
 GP577RT-BL00-MS (for GP570-TC21 - Rev. E *¹)



GP-70 Series Installation Fasteners
 GP070-AT00-MS



Moisture Resistant Gasket
 GP470-WP10-MS (for GP-470 Series)
 GP570-WP10-MS (for GP-570 Series)

1 The Rev. (revision) seal can be found on the back of the unit (see below). The “” mark indicates the unit’s revision code.

Rev. ABCD*FGHIJ KLMNOPQRST UVWXYZ 123

Chapter 1 - Introduction

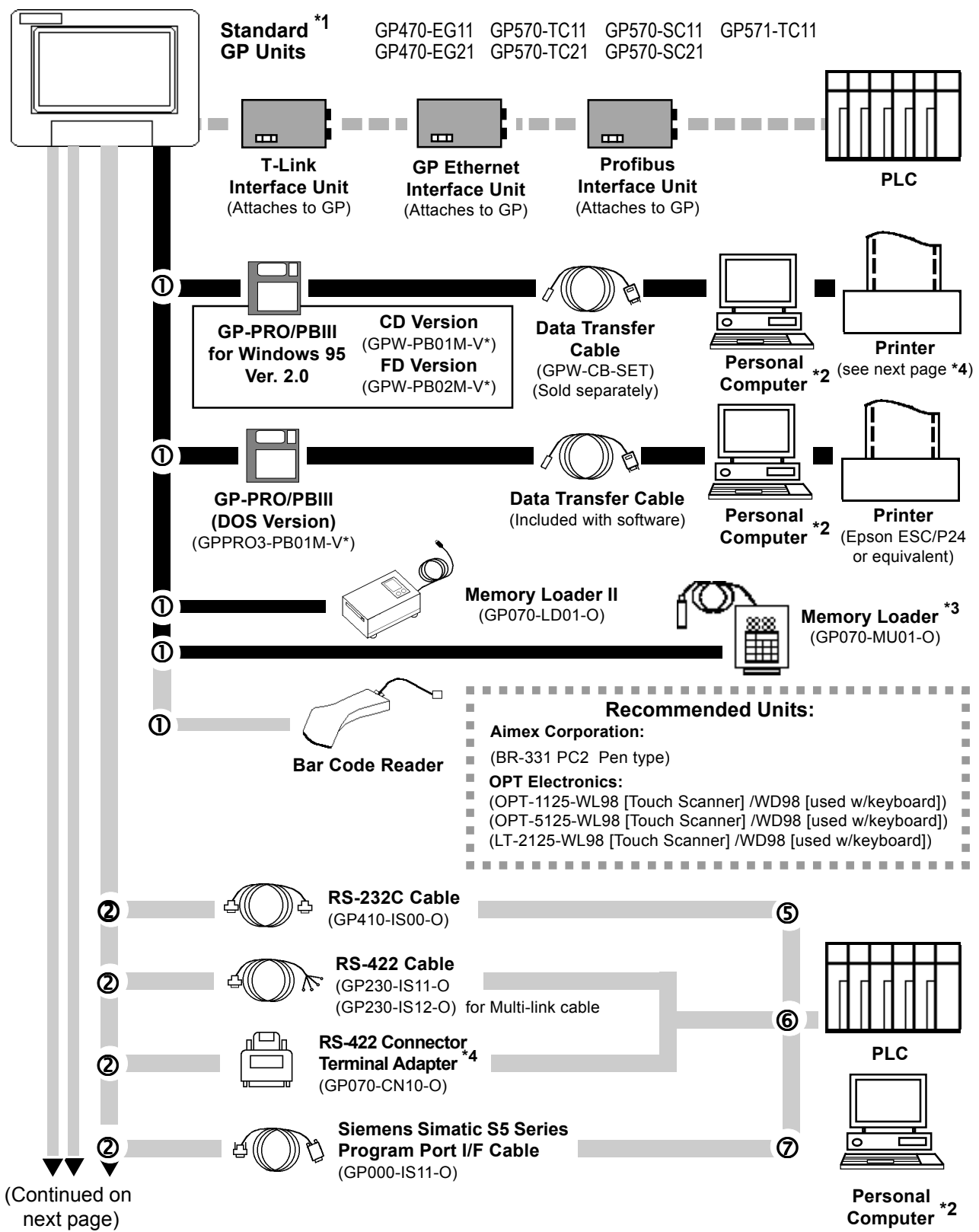

(Continued on next page)

^{*1} If the GP's rear ID sticker is copper colored, the unit is equipped with backup SRAM.
Reference Package Contents
^{*2} IBM PC or compatible. (Certain non-standard PCs cannot be used) **Reference Operation Manual**
^{*3} Cannot be used with system versions 1.20 or higher.
^{*4} Certain types and models of PLCs can not be connected. **Reference PLC Connection Manual**

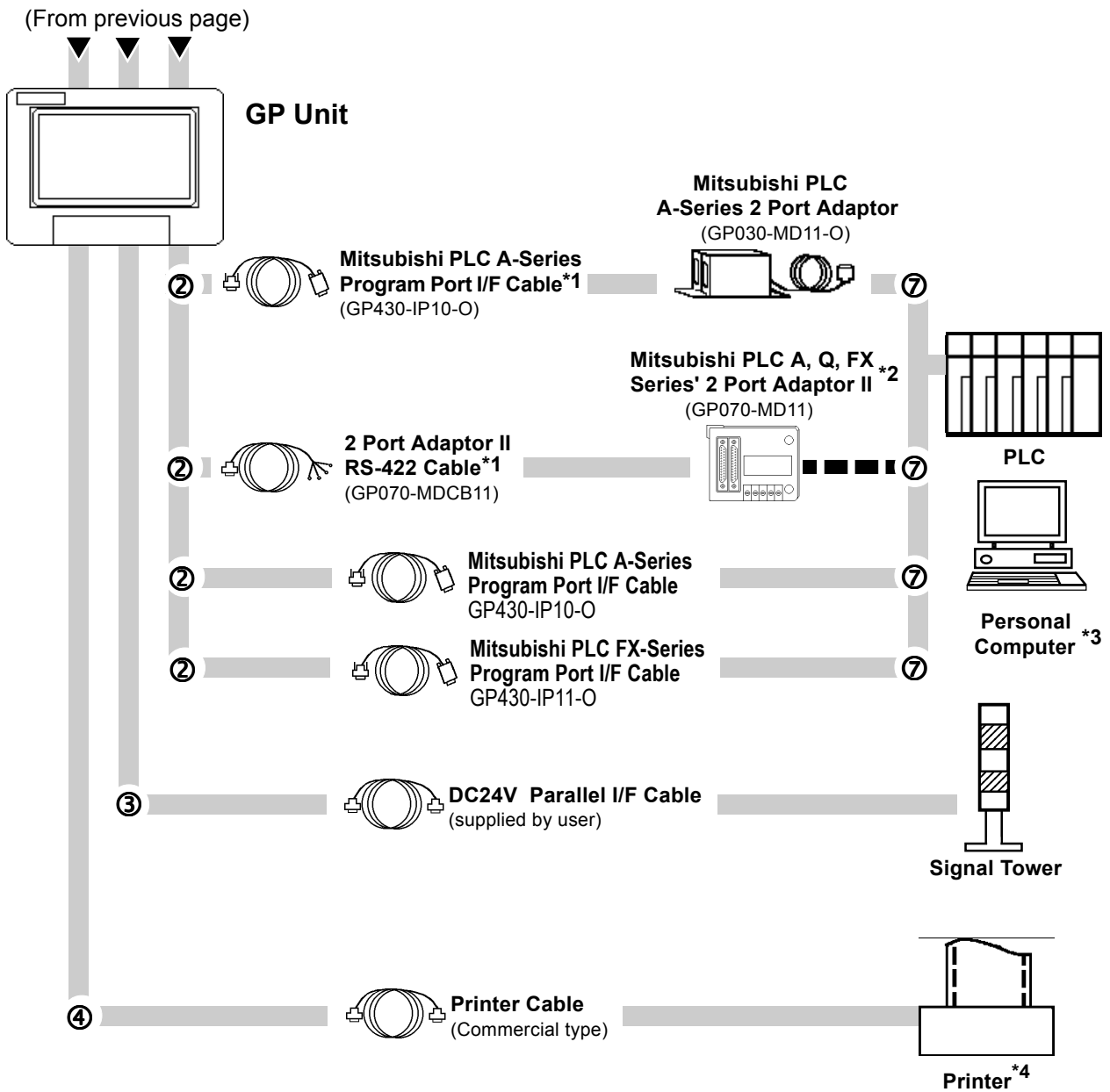

*1 The User can prepare and use their own cable as well.

*2 When using the 2-Port adaptor II with a Mitsubishi FX series unit, a special Mitsubishi cable is required.

*3 IBM PC or compatible. (Certain non-standard PCs cannot be used) **Reference** **Operation Manual**

*4 Dedicated Windows (95,98) printers cannot be used. Be sure, when selecting a printer, to confirm that the unit supports HP LaserJet PCL, NEC PR Series, or EPSON ESC/P24-84 or equivalent. Certain printers with both Windows and DOS drivers may be used.

Chapter 1 - Introduction

1.3 Optional Equipment

All optional equipment listed below is produced by the Digital Electronics Co.

	ITEM	DESCRIPTION
Screen Creation/Editing Software	GP-PRO/PB III for Windows95 (GPW-PB01M-V*<CD-ROM>) (GPW-PB02M-V*<Floppy disk>)	GP-PRO/PB III PC based screen design software for use with GP-70 series display screens.
	Data Transfer Cable Set (GPW-CB-SET)	Data Transfer Cable Connects your PC to the GP, allowing screen data to be transferred between the two.
Serial Interface Cables/Units	RS-232C Cable (GP410-IS00-O)*1	I/F cable to connect GP to the Host (PLC).
	RS-422 Cable (GP230-IS11-O) *1	
	Multi-link Cable (GP230-IS12-O) *1	Allows multi-link (n:1) SIO between the Host (PLC) and the GP. Standard RS-422 interface cable.
	RS-422 Terminal Adapter (GP070-CN10-O)	Adapter for converting output from a serial interface to RS-422 I/F.
	Siemens Simatic Series Programming Port I/F Connection Cable (GP000-IS11-O)	TTY converter cable for Siemens Simatic S5 Series PLCs. Simultaneous use of program console is not possible.
	Mitsubishi A Series Programming Port I/F cable (GP430-IP10-O)	Connects directly to Mitsubishi's FX Series I/F Programming Console. Conversion link unit not necessary. Simultaneous use of program console, however, is not possible.
	Mitsubishi PLC FX Series Programming Port I/F Cable (GP430-IP11-O)	
Mitsubishi PLC A Series 2 Port Adapter (GP070-MD11)	Interface unit that allows use of both GP and Mitsubishi A series equipment in the same location.	
Option Items	<u>Cover Sheets</u> GP-470 Series (GP470-COVER-*0P) or (GP470-DF10-O) [hard type] GP-570 Series (GP570-COVER-*0P) or (GP570-DF10-O) [hard type]	Disposable sheets provide protection from a variety of elements. The GP's touch panel can be used with this cover sheet attached. (20 sheets/set)

*1 Certain types of PLC's cannot be connected. **Reference** *PLC Connection Manual*.

Maintenance Parts	<u>GP-570 Backlight Bulbs</u> GP-570 Series (GP570-BL00-MS) (GP577RT-BL00-MS) *1	Replacement backlight bulbs for GP-570 series units.
	<u>Installation Fasteners</u> (GP070-AT00-MS)	Installation fasteners for GP-70 series units.
	<u>Moisture Resistant Gasket</u> GP-470 Series (GP470-WP10-MS) GP-570 Series (GP570-WP10-MS)	Used when installing the GP to provide a moisture resistant seal. Same as the seal included in the GP's original equipment package.
Data Copy Units	Memory Loader*2 (GP070-MU01-O)	Copies data at high speed from one GP to another. (Both system program and screen data)
	Memory Loader II*3 (GP070-LD01-O)	Copies data at high speed from one GP to another. (Both system program and screen data)

*1 With GP570-TC21 units that are Rev. E, when changing the backlight, be sure to use backlight model GP577RT-BL00-MS.

*2 Cannot be used with system versions 1.20 or higher.

*3 Certain functionality present in the Japanese unit is not available in the English unit.



The Rev. (revision) seal can be found on the back of the unit (see below). The "*" mark indicates the unit's revision code.

Rev. ABCD*FGHIJ
 KLMNOPQRST
 UVWXYZ 123

Chapter 2

Specifications

1. General Specifications
2. Features and Performance
3. Interface Specifications
4. Names and Functions of GP Parts
5. Graphic Panel Dimensions

2.1 General Specifications

1. Electrical Specifications

For GP470-EG11, GP570-TC11, GP570-SC11, GP571-TC11 models.

	GP470-EG11	GP570-TC11 GP571-TC11	GP570-SC11
Input Voltage	AC 85V to 132V 50/60 Hz		
Power Consumption	Under 50 VA		
Allowable Power Failure	Less than 20mS		
Voltage Endurance	AC1500V--20mA 1minute (between the live wire and grounding terminals)		
Isolation Resistance	DC500V--above 10MOhm (between the live wire and grounding terminals)		

For GP470-EG21-24VP, GP570-TC21-24VP, GP570-SC21-24VP, GP470-EG31-24V, GP570-TC31-24V, GP570-SC31-24V models.

	GP470-EG21-24VP GP470-EG31-24V	GP570-TC21-24VP GP570-TC31-24V	GP570-SC21-24VP GP570-SC31-24V
Input Voltage	DC 24V±20%		
Power Consumption	Under 50 W (TYP 20W)		
Voltage Endurance	AC1000V (10mA for 1 minute) between the live wire and grounding terminals		
Isolation Resistance	DC500V (above 10MOhm) between the live wire and grounding terminals		

2. Environmental Specifications

	GP470-EG**	GP570-TC** GP571-TC**	GP570-SC**
Operating Temperature	0 to 50 degrees Celsius	0 to 40 degrees Celsius	
Storage Temperature	-10 to 60 degrees Celsius		
Ambient Humidity	20 to 85%RH (non-condensing)	30 to 85%RH (non-condensing)	
Vibration Endurance	10 to 25 Hz (X,Y,Z directions 30 minute each 2G)		
Noise Endurance	Noise voltage: 1200 Vp-p However, for GP*70-**21 and GP*70-**31 models, the level is 1000 Vp-p		
	Pulse length: 1 microsecond		
	Arise time (rise/fall): 1 nanosecond		
Atmosphere	Not immune to corrosive gas		
Ground Connection	Less than 100 Ω/ Use 2mm ² or larger wire. *2		
Protective Structure *1	Equivalent to IP65f (JEM1030) and NEMA #250 TYPE4X/12		

*1 The front face of the GP unit, installed in a solid panel, has been tested using conditions equivalent to the standards shown in the specification. Even though the GP unit's level of resistance is equivalent to these standards, oils that should have no effect on the GP can possibly harm the unit. This can occur in areas where either vaporized oils are present, or where low viscosity cutting oils are allowed to adhere to the unit for long periods of time. If the GP's front face protection sheet becomes peeled off, these conditions can lead to the ingress of oil into the GP and separate protection measures are suggested. Also, if non-approved oils are present, it may cause deformation or corrosion of the front panel's plastic cover. Therefore, prior to installing the GP be sure to confirm the type of conditions that will be present in the GP's operating environment. If the installation gasket is used for a long period of time, or if the unit and its gasket are removed from the panel, the original level of the protection cannot be guaranteed. To maintain the original protection level, you need to replace the installation gasket regularly.

*2 Use your country's applicable grounding.

3. Structural Specifications

	GP470-EG**	GP570-TC** GP571-TC**	GP570-SC**
External Dimensions (mm)	274W x 216H x 56.5D mm (GP unit only)	317W x 243H x 85D mm (GP unit only)	
Weight	Under 2.5 kg (GP unit only)	Under 3.5 kg (GP unit only)	
Cooling System	Natural air circulation		

Chapter 2 - Specifications

2.2 Features and Performance

1. Display Features

	GP470-EG	GP570-TC** GP571-TC**	GP570-SC**
Display Medium	High Intensity EL Display	TFT type color LCD	STN type color LCD
Display Color	Amber (monochrome)	8 colors (white, red blue, green, yellow, purple, light blue, black) Tiling patterns make blends of colors possible. Only the GP571-TC** can display 64 colors on its Image (I) screens.	
Backlight	---	CFL (under normal temperatures and humidity, lifespan = 20,000 hours *1)	
Resolution	640 x 400 pixels	640 x 480 pixels	
Display Area	192W x 120H	211W x 158H	
Attributes	Blink/ Reverse video		
Brightness	Touch Panel has two levels of Brightness adjustments.	-----	
Contrast	-----		8 levels available
Characters	Korean: (KSC5601-1992 codes) Hangeul fonts (including Kanji)		
	Chinese: (GB2321-80 codes) simplified Chinese fonts		
	Taiwanese: (Big 5 codes) traditional Chinese fonts		
	ASCII :(Code Page850) Alphanumeric (including European fonts)		
	Japan: ANK 158 type, Kanji:6349 (Standard JIS Type 1 and Type 2)		
No. of Char. Disp	8x8 dot font	80 Char./row,50rows	80 Char. per row, 60 rows
	8x16 dot font	80 Char./row, 25rows	80 Char. per row, 30 rows
	16x16 dot font	40 Char./row,25rows	40 Char. per row, 30 rows
Character Size	Both height and width can be expanded 1, 2, 4, or 8 times. Chinese characters larger than 2 times size (32 x 32) can be displayed in a high quality font.		



Note: Since it uses more colors, the display and printing speeds of the GP571-TC** are slower than the GP570-TC**.

*1 With GP570-TC21 units that are Rev. E, the estimated lifetime of the backlight is 40,000 hours (assuming 24 hour operation).



• **The Rev. (revision) seal can be found on the back of the unit (see below). The “*” mark indicates the unit’s revision code.**



2. Screen Memory

	GP470-EG**	GP570-TC** GP571-TC**	GP570-SC**
Internal Memory	FLASH EPROM 1M byte (approx. 320 screens, 3.2K bytes/screen) However, GP571-TC** has 3M bytes (approx, 960screens, 3.2k bytes/screen).		
Backup *1 Memory	SRAM 32K bytes (768 messages) The Backup Memory uses Lithiumbatteries. *2		

*1 Only available on units with backup SRAM built in.

*2 The battery life of the GP-470/570's lithium battery, when the battery is 40°C or less, is over 10 years. At 50°C or less it is over 4.1 years, and at 60°C or less it is more than 1.5 years.

Chapter 2 - Specifications

3. Touch Panel / Clock Accuracy

	GP470-EG**	GP570-TC** GP571-TC**	GP570-SC**
Touch Panel	32x20 keys/ screen (1 or 2 point touch)	32 x 24 keys/ screen (1 or 2 point touch)	
Clock Accuracy	+/- 65 seconds/ month (at room temperature)		

4. External Interfaces

	GP470-EG**	GP570-TC** GP571-TC**	GP570-SC**
Serial Interface	Asynchronous Transmission Method: RS232C/RS422 (Supports various PLC protocols) Data Length: 7 or 8 bits Stop Bit: 1 or 2 bits Parity: None, Odd or Even Data Transmission Speed: 2400 to 115.2kbps		
Auxiliary Input/Output (AUX)	Touch Switch Output (for inching): DC 24V 8 points System Alarm Output: DC24V 1 point Buzzer Output: DC24V 1 point RUN Output: DC24V 1 point Remote Reset Input: DC24V 1 point		
Printer Output	Conforms to Centronix standards (HP LaserJet PCL4 compatible, NEC PR series, EPSON ESC/P24 or equivalent can be connected)		
Tool Connector I/F	RS-232C Asynchronous Transmission Method, TTL level non-procedural command interface During Program Development - Connect the data transfer cable to download screen data During GP RUN mode - Connect a Bar-code reader		

- 1) Dedicated Windows (95,98) printers cannot be used. Be sure, when selecting a printer, to confirm that the unit supports HP LaserJet PCL, NEC PR Series, or EPSON ESC/P24-84 or equivalent. Certain printers with both Windows and DOS drivers may be used.

2.3 Interface Specifications

1. Printer Interface

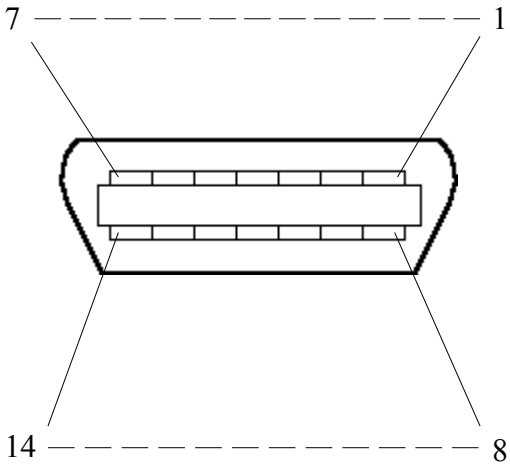
Pin Connection	Pin #	Signal Name
	1	$\overline{\text{PSTB}}$
	2	PDB0
	3	PDB1
	4	PDB2
	5	PDB3
	6	PDB4
	7	PDB5
	8	PDB6
	9	PDB7
	10 ^{*1}	$\overline{\text{INIT}}$
	11	BUSY
	12	Reserved
	13	Reserved
	14	GND

**1 When the $\overline{\text{INIT}}$ signal is not used, no.10 pin does not need to be connected.*

Recommended Connector : FCN-787P014-G/R (made by Fujitsu, Inc.)

Recommended Cover : FCN-780C014-D/E (made by Fujitsu, Inc.)



Do not connect pins 12 and 13 to anything.

Chapter 2 - Specifications

2. AUX I/F (Input/ Output)

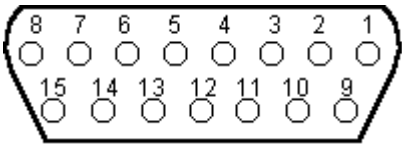
Pin Connection	Pin #	Signal Name	Contents
	1	TSW0	Touch Switch Output (8 bit)
	2	TSW1	
	3	TSW2	
	4	TSW3	
	5	TSW4	
	6	TSW5	
	7	TSW6	
	8	TSW7	
	9	RUN	Output On in the middle of operations, Off during Power interruption or in standby mode
	10	ALARM	Alarm Output: when On, enables GP unit alarm.*1
	11	BUZZ	Buzzer Output
	12	DC24V	Output--Common (DC24V)
	13	AIN - C	Input--Common (DC24V)
	14	AOUT - C	Output--Common (GND)
	15	RESET	Reset Input

***1 AUX Input/Output I/F's pin no.10 Alarm**

The AUX Alarm will occur in the following two cases:

- Hardware Alarm (SCREEN MEMORY CHECKSUM ERROR)
- Software Alarm (SYSTEM ERROR, i.e., incorrect data that makes screen operation impossible)

Dsub15 pin Plug : XM2A-1501 (made by Omron Corp.)

Dsub15 pin Cover : XM2S-1511 (made by Omron Corp.)

Screws : XM2Z-0071 (made by Omron Corp.)



Use rough metric type M2.6x0.45p threads used to hold the cable's set (fastening) screws in place.

Input Circuit

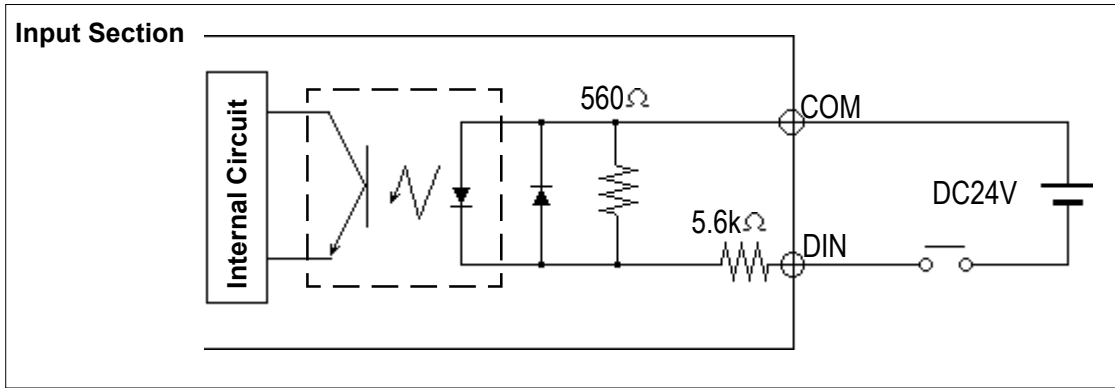

Input Voltage	DC 24V +/- 10%	Operating Voltage	ON Voltage min. DC 21.1V OFF Voltage max. DC 3V
Input Current	4mA/DC 24V (TYP)	Termination Type	Photo-Coupler Terminator
Min. Input Pulse Width	2ms		

Output Circuit

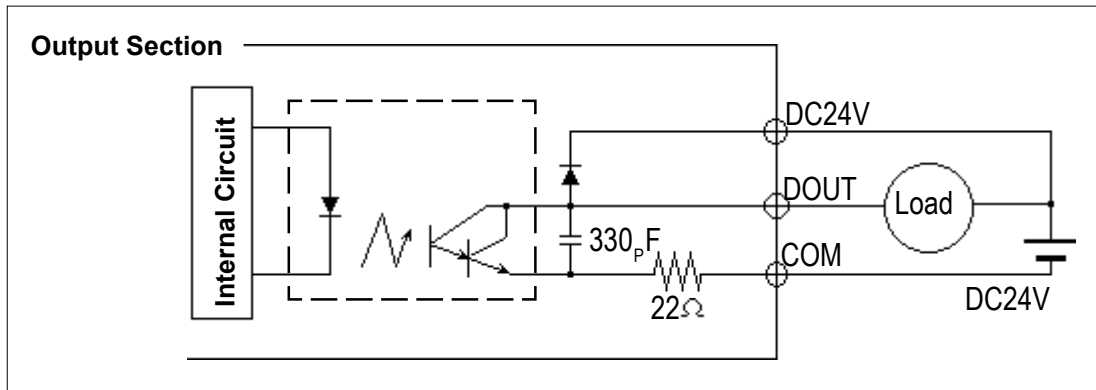

Maximum Load Current **50mA / point**
Regulated Load Voltage **DC24V (TYP)**

The relationship between the Load Voltage and the Load Current is as follows:

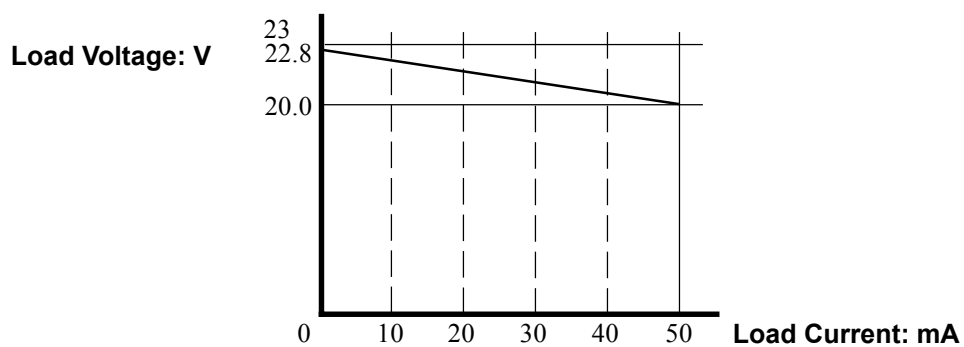

3. Serial Interface

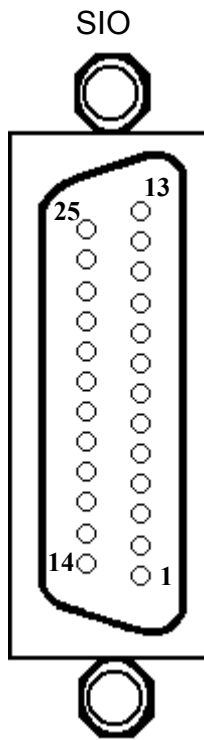

Pin #	Signal Name	Condition	Pin #	Signal Name	Condition
1	FG	Frame ground	14	VCC	5V \pm 5% output 0.25A
2	SD	Send data (RS-232C)	15	SDB	Send data B (RS-422)
3	RD	Receive data (RS-232C)	16	RDB	Receive data B (RS-422)
4	RS	Request send (RS-232C)	17	NC	No connection
5	CS	Clear send (RS-232C)	18	CSB	Clear send B (RS-422)
6	NC	No connection	19	ERB	Enable receive B (RS-422)
7	SG	Signal ground	20	ER	Enable receive (RS-232C)
8	CD	Carrier detect (RS-232C)	21	CSA	Clear send A (RS-422)
9	TRMX	Termination (RS-422)	22	ERA	Enable receive A (RS-422)
10	RDA	Receive data A (RS-422)	23	RESERVED	Reserved for future use
11	SDA	Send data A (RS-422)	24	NC	No connection
12	NC	No connection	25	RESERVED	Reserved for future use
13	NC	No connection			



Note: Recommended Connector: Dsub25pin plug XM2A-2501 <made by OMRON Corp.>
 Recommended Cover: Dsub25pin Cover XM2S-2511 <made by OMRON Corp.>
 Jack Screw XM2Z-0071 <made by OMRON Corp.>

Use rough metric type **M2.6x0.45p** threads used to secure the cable's set screws.

Recommended Cable: CO-MA-VV-SB5S x 28AWG <made by HITACHI Cable Ltd.>

To determine your PLC's connection: **Reference PLC Connection Manual**

When creating your own cable, follow the instructions listed below:

RS-422 (The following pairs of pin #'s must be connected to each other)

#18 (CSB) \longleftrightarrow #19 (ERB)

#21 (CSA) \longleftrightarrow #22 (ERA)

- When connecting the RS-422 cable and the #9 (TRMX) and #10 (RDA) points, a termination resistance of 100 Ω is added between RDA and RDB.
- When making a cable for the Memory Link format, be sure to select a 4-line System.

RS-232C

- Do not use the following pins: 9 (TRMX), 10 (RDA), 11 (SDA), 15 (SDB), 16 (RDB), 18 (CSB), 19 (ERB), 21 (CSA), 22 (ERA).



Caution

This unit's RS-485 (RS-422) Port is not isolated. Therefore, it is crucial that you connect the SG/GND (Signal Ground) terminals. Failure to do so may result in damage to the RS-485 (RS-422) circuit.

2.4

Names and Functions of GP Parts

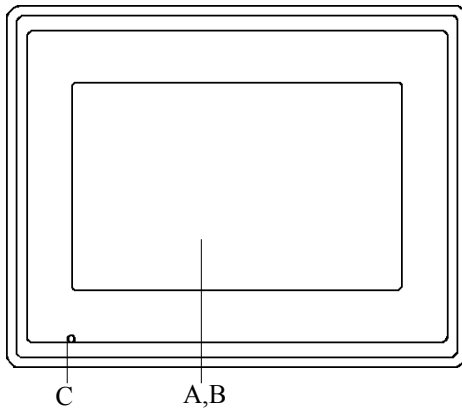

A: Display Panel

The GP monitor screen displays the screen setup and corresponding PLC host data.

GP470-EG** High Intensity EL Display

GP570-TC** TFT type Color LCD

GP571-TC** TFT type Color LCD

GP570-SC** STN type Color LCD

B: Touch Panel (overlaid on top)

Runs any screen change operations and sends data to the PLC.

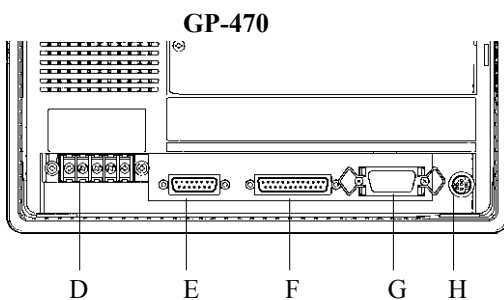

C: Power Lamp

Lights when the power cord is connected. (Green LED)

D: Power Input Terminal Block

The input and ground terminals for the AC power cable.

E: Auxiliary Input/Output (AUX)

Operates the Touch Switch, System Alarm, Buzzer, and RUN output signals, and Remote Reset input signals.

F: Serial Interface

Used for the RS-232C and RS-422 (Serial) interfaces. Are connected to the Host (PLC).

G: Printer Interface

The Printer is connected here.

H: Tool Connector

The Data Transfer cable, Bar Code Reader or Memory Loader can be connected here.

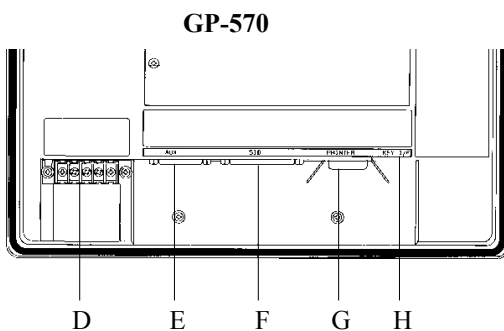

2.5 Graphic Panel Dimensions

1. GP-470 Series - External Dimensions

Unit: mm

Top View

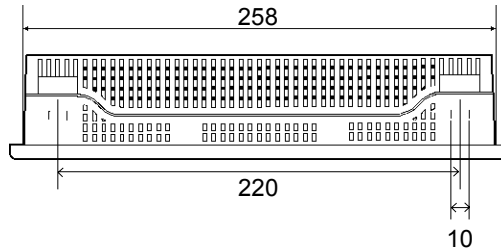

Front View

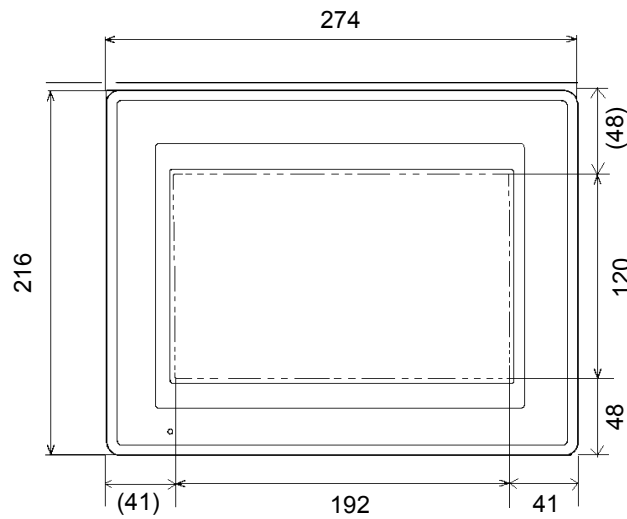

Side View

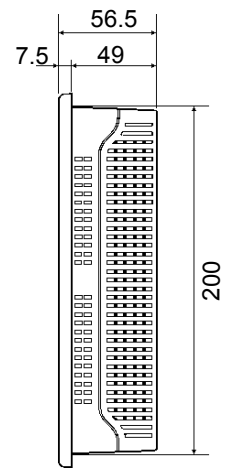

Rear View

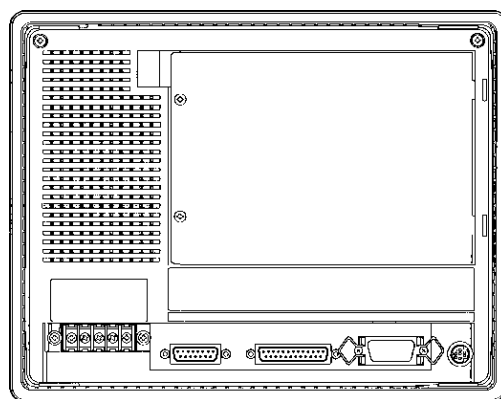

2. GP-570 Series - External Dimensions

Unit: mm

Top View

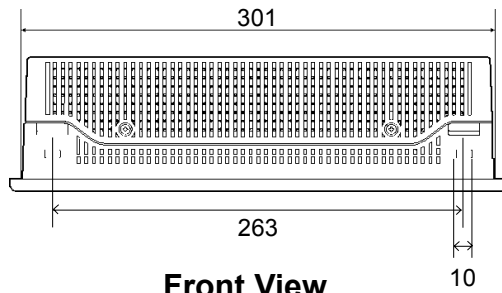

Front View

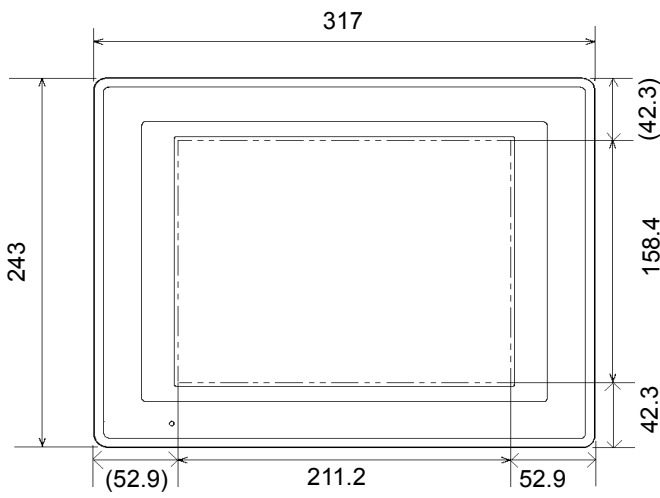

Side View

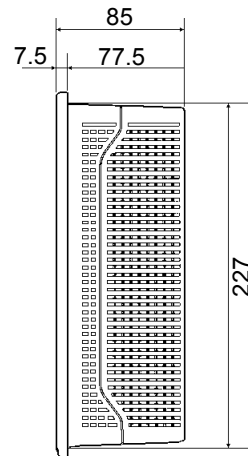

Rear View

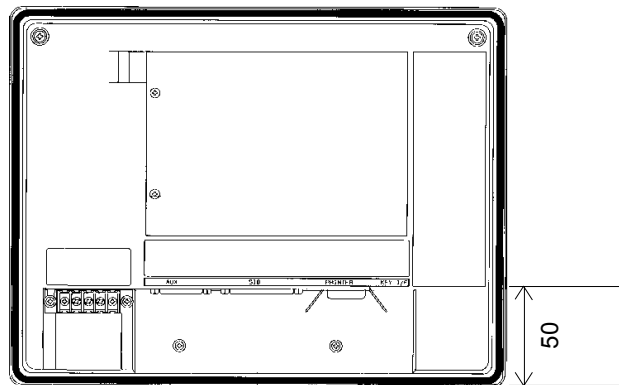

Chapter 2 - Specifications

3. Installation Fasteners

Unit: mm (in.)

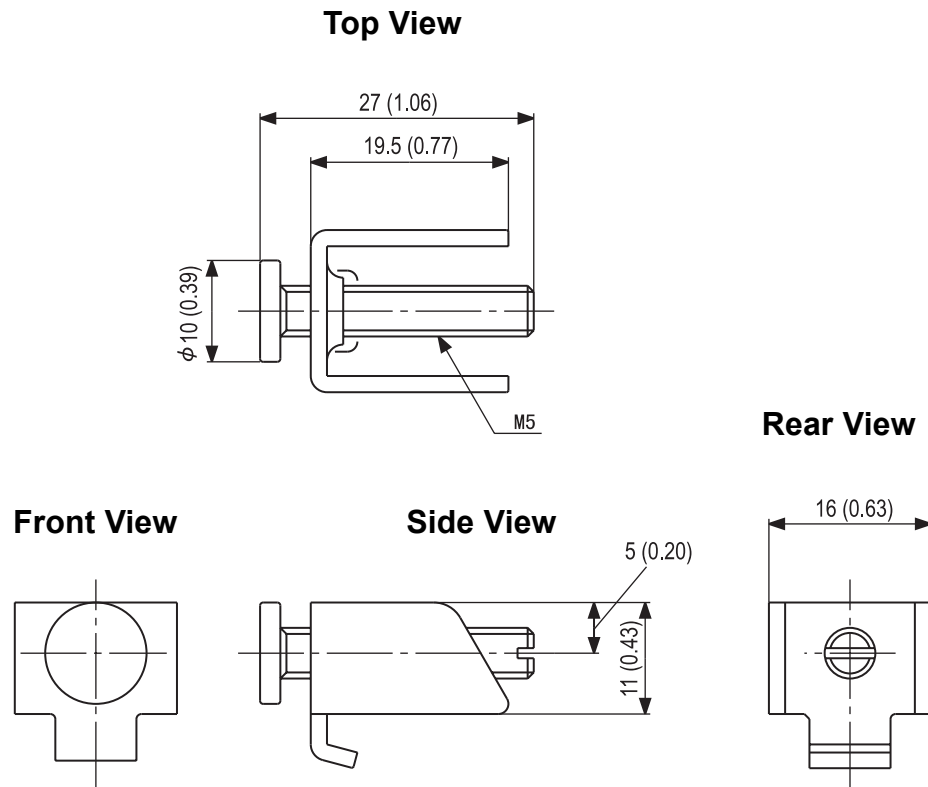

4. GP Installation Mounting Hole Dimensions

Unit: mm

Installation Mounting Hole

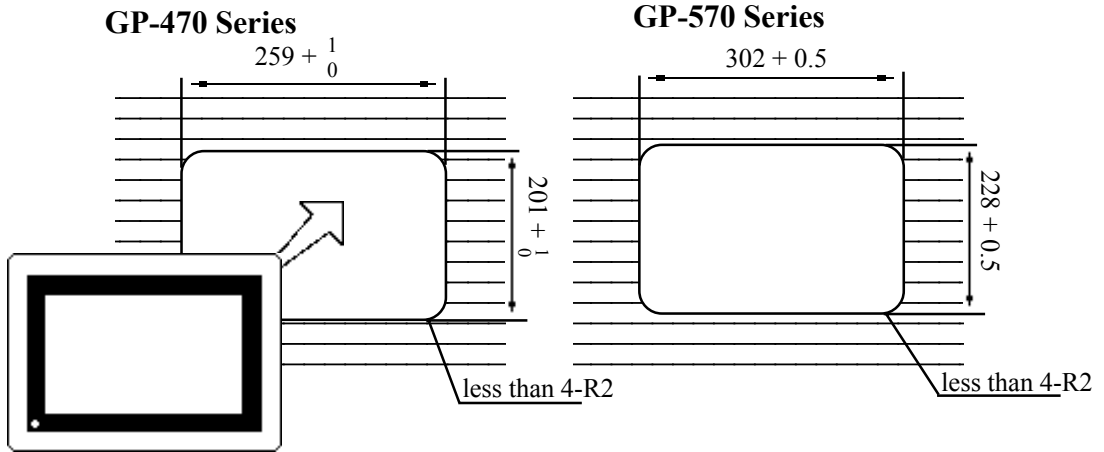

Chapter 3

Installation and Wiring

1. Installation
2. Wiring Cautions
3. Connecting the Printer Cable
4. GP Tool Connector

3.1 Installation



Before installing the GP into a cabinet or panel, check that the installation gasket is securely attached to the unit.

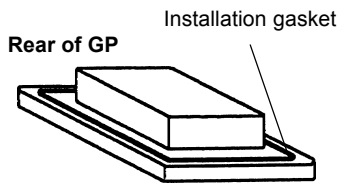

It is strongly recommended that you use the gasket since it absorbs vibration in addition to repelling water.

Place the GP on a level surface with the display panel facing downward. Check that the GP's installation gasket is seated securely into the gasket's groove, which runs around the perimeter of the panel's frame. For details about installing the gasket, refer to

Reference 7.1.2 *Installation Gasket Check/Replacement*

■ Creating a Panel Cut Out

Create the correct sized opening required to install the GP, using the installation dimensions given.

Reference 2.5.3 *“GP Panel Cut Out Dimensions”*

The installation gasket, installation brackets and attachment screws are all required when installing the GP.

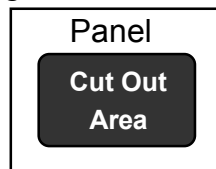

- Check that the installation panel or cabinet's surface is flat, in good condition and has no jagged edges.
- Panel thickness should be from 1.6mm (0.06in.) to 5.0mm (0.2in.).

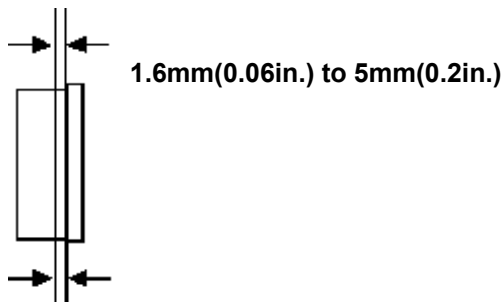

Decide the panel's thickness based on the level of panel strength required.



- For easier maintenance and operation, plus better ventilation, ensure the GP unit is mounted at least 100 mm away from adjacent structures and other parts.

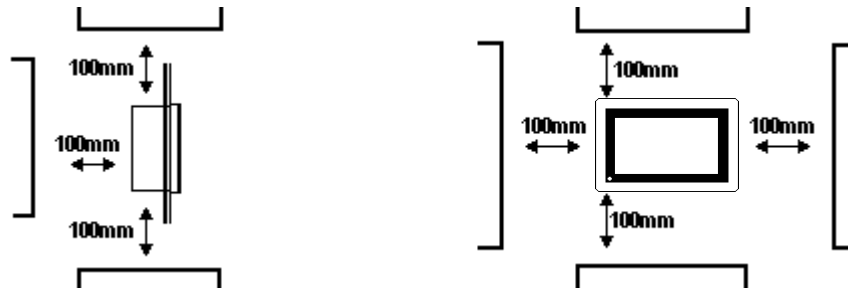

- The GP uses ventilation in its outer shell to naturally cool itself. When installing the unit horizontally or sideways, use a forced air cooling system (i.e. a fan) or lower the surrounding temperature to avoid overheating.

Horizontal Installation

(Landscape style)

Side View

Front View

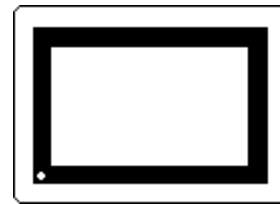

(Looking down at)

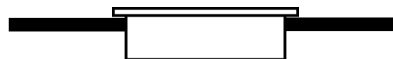

Vertical Installation

(Portrait Style)

Side View

Front View

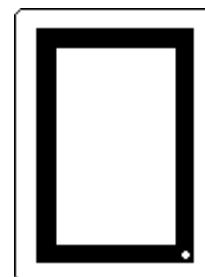
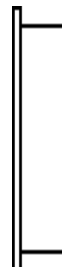

Chapter 3 - Installation and Wiring



- When installing the GP vertically, orient the unit so that the Power Terminal Block points upwards.
- Be sure that heat from surrounding equipment does not cause the GP to exceed its standard operating temperature.
- Do not use GP-470 Series units in an environment that exceeds 50° C; do not use GP-570 Series in an environment that exceeds 40° C.
- Ensure this unit is located as far away as possible from electromagnetic circuits, non-fuse type breakers, and other equipment that can cause arcing.
- When installing the GP unit, with natural air circulation cooling system, onto a slanted panel, the panel slope should not incline more than 30°.

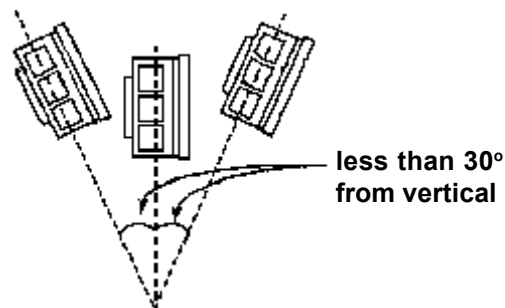

2. Installation Direction

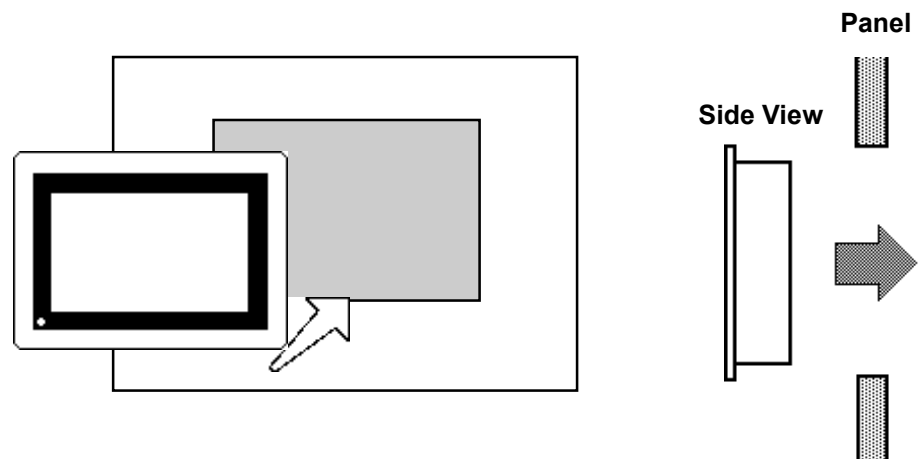

3. Securing the Installation Fasteners

There are 4 insertion slots on the top and bottom of the GP, where the metal installation fasteners hook on.

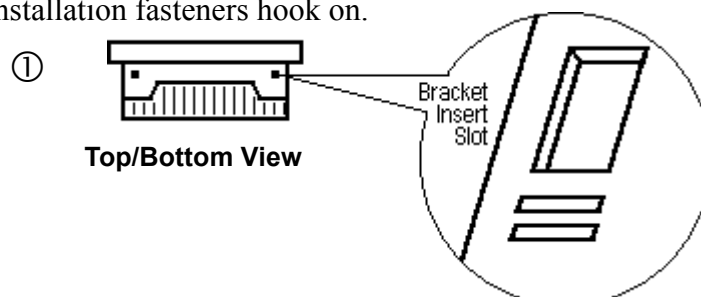

4. Inserting and Tightening the Fasteners

Insert each of the fasteners into its slot as shown below. Be sure to pull the fastener back until it is flush with the rear of the attachment hole.

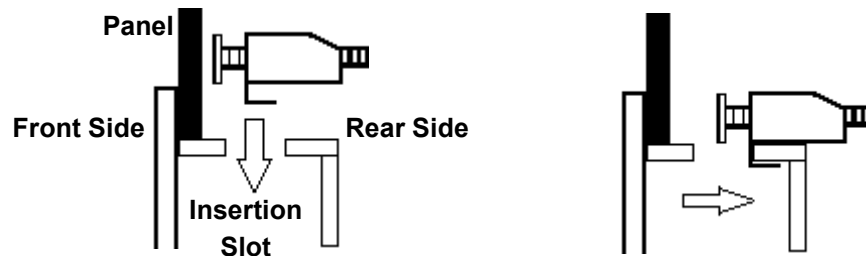

Use a screw driver to tighten the attachment screws and secure the GP unit in place.

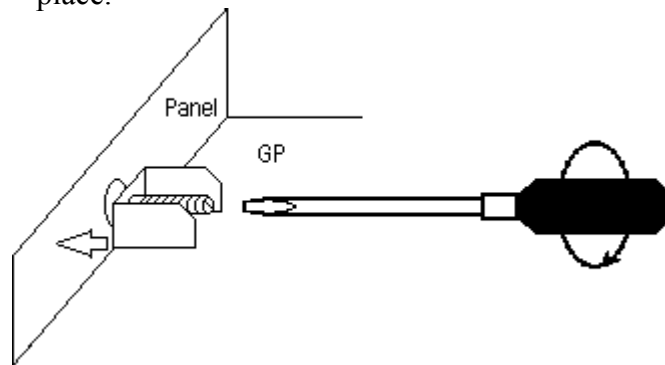

A torque of only 0.5~0.6 N·m is required to tighten an attachment screw. Be careful not to use too much force, since it may damage the GP unit.

3.2 Wiring Cautions

1. Connecting the GP's Power Cable



- To avoid electric shocks, be sure the Power Cable is unplugged from the power outlet when connecting the cable to the GP unit.
- The following units use an input voltage of AC100V:
GP470-EG11, GP570-TC11, GP570-SC11,
GP571-TC11
and the following units use an input voltage of DC24V:
GP470-EG21-**, GP470-EG31-**, GP570-TC21-**,
GP570-TC31-**, GP570-SC21-**, GP570-SC31-**
Be sure to use the correct power supply for your GP unit, since using an incorrect power supply may damage both the power source and the GP.
- Please connect a breaker unit as a power switch for your GP.
- When connecting the GP power cord's power terminals, be sure to ground the  terminal, since there is possibility of an electric shock if the GP malfunctions.



When the FG terminal is connected, be sure the wire is grounded. Not grounding the GP unit will result in excess noise.



- Wherever possible, use thick wires (max 2mm²) for power terminals, and twist the exposed wire ends when connecting the Ring Terminals.
- Please use Ring Terminals with the size described below.

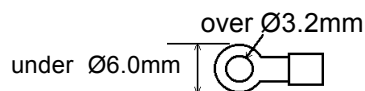

- To prevent the Ring Terminals from causing a short when the terminal block attachment screws are loosened, be sure to use sleeve-type Ring Terminals.
- Do not wire the cable either near or parallel to high voltage or high current power lines.
- Be sure that any DC24V power line used provides sufficient power for the GP and that the voltage does not fluctuate.

For GP470-EG11, GP570-TC11, GP570-SC11, GP571-TC11 models

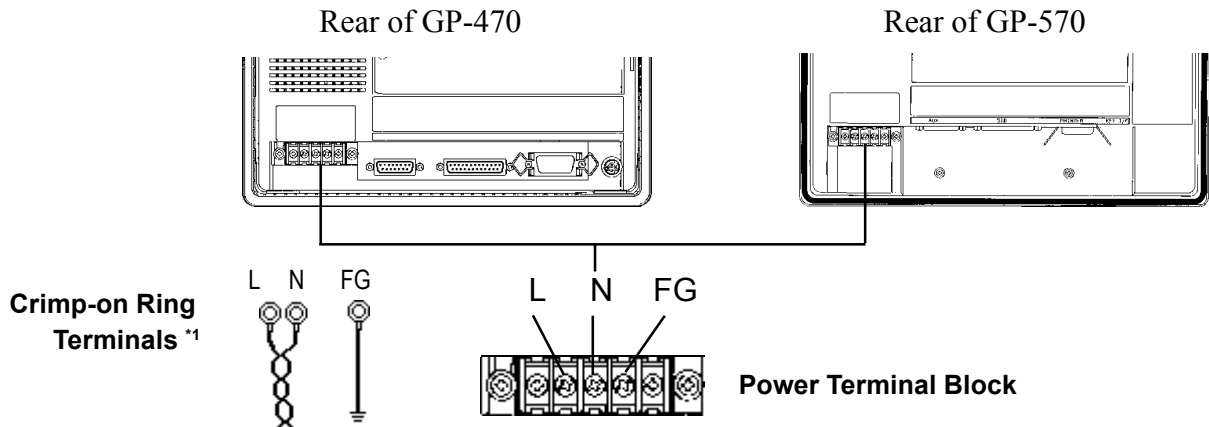

For GP470-EG21-24VP, GP470-EG31-24V, GP570-TC21-24VP, GP570-TC31-24V, GP570-SC21-24VP, GP570-SC31-24V models.

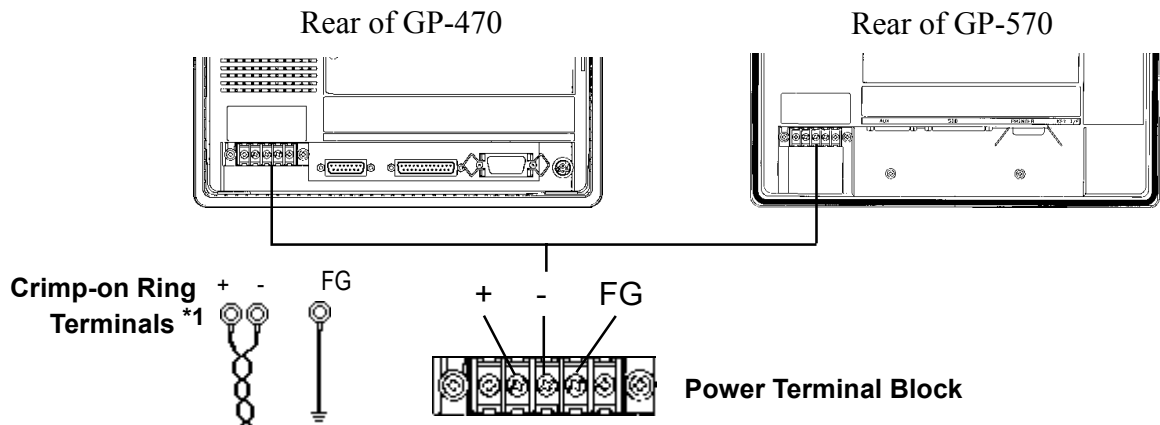

2. Connecting the GP Power Supply Terminals

- 1) Be sure that the GP's Power Cord is not plugged in to the power supply.
- 2) Remove the GP Terminal Strip's clear plastic cover.
- 3) Remove the screws from the 3 middle terminals, position the Ring Terminals as shown above and re-attach the screws. (Check each wire to make sure the connections are correct)



A torque of only 0.5~0.6 N·m is required to tighten an attachment screw. Be careful not to use too much force, since it may damage the GP unit.

*1 The three ring terminals are:

AC100V L	= AC Input Terminal - live line
AC100V N	= AC Input Terminal - neutral line
FG	= Ground terminal - connected to the GP chassis

Recommended ring terminal: V2-MS3 or equivalent
(Made by JST Corporation)

3. Connecting the GP's Power Supply

When using the 470-EG11, 570-TC11, 570-SC11 and 571-TC11 models, please pay special attention to the following items.

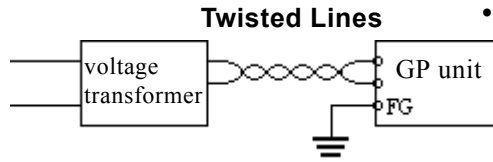

- If the supplied voltage exceeds the GP unit's range, connect a voltage transformer.

Reference Chapter 2, "Specifications", for the allowable voltage range.

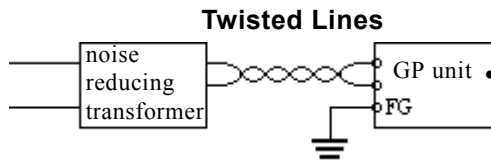

- For between the line and ground, select a power supply that is low in noise. If there is an excess amount of noise, connect a noise reducing transformer.

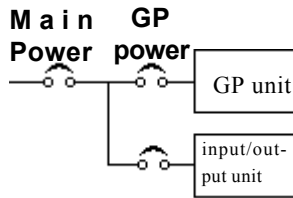

Note:

Use Voltage and Noise Reducing transformers with capacities exceeding 100VA.

- When supplying power to the GP unit, please separate the input/output and operation unit lines as shown in the figure.

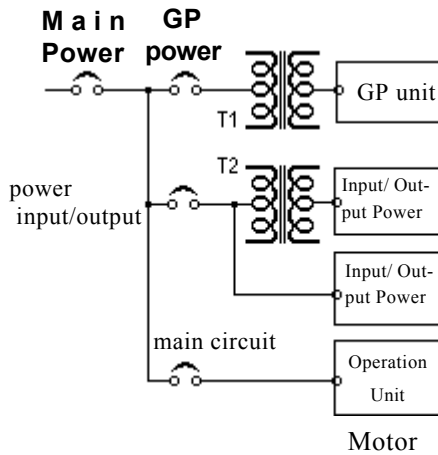

- To increase the noise resistance quality of the power cable, simply twist each power wire before attaching the Ring Terminal.
- The power supply cable must not be bundled or positioned close to main circuit lines (high voltage, high current), or input/output signal lines.

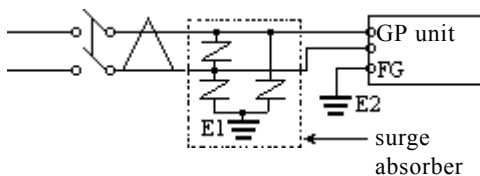

Note:

Make sure the surge absorber (E1) is grounded separately from the GP unit (E2).

- Select a lightning surge absorber that has a maximum circuit voltage greater than that of the expected power supply surges.

4. Grounding the GP

(a) Exclusive grounding (BEST)

GP unit other equipment

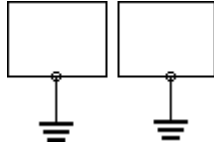

- Connect the FG terminal found at the back of the unit to an exclusive ground. [diagram (a). Grounding resistance of under 100Ω.]

- If exclusive grounding is not possible, use a common connection point. [diagram (b)]

(b) Common grounding (OK)

GP unit other equipment

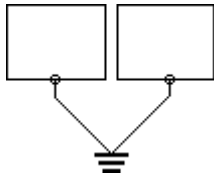

- The grounding wire should have a cross sectional area greater than 2mm². Set the connection point as close to the GP unit, and make the wire as short, as possible. When using a long grounding wire, replace the thin wire with a thicker wire placed in a duct.

(c) Common grounding (Not OK)

GP unit other equipment

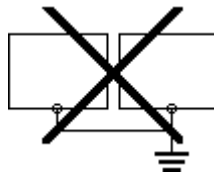

- If this equipment does not function properly when grounded, disconnect the ground wire from the FG terminal.

5. Placement of I/O Signal Lines

- Input and output signal lines must be separated from the power control cables for operating circuits.
- If this is not possible, use a shielded cable and connect the shield to the GP's frame.

3.3 Connecting the Printer Cable

The steps to connect a printer to the GP are outlined below.

(A special 14 pin Centronix printer cable is required)

GP-470 Series (rear face)

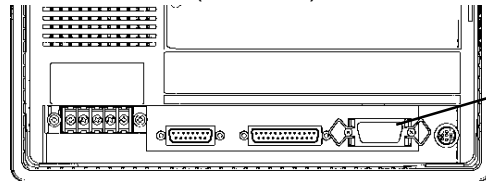

**Printer Interface
(Printer Cable Connector)**

GP-570 Series (rear face)

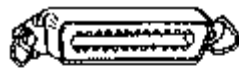
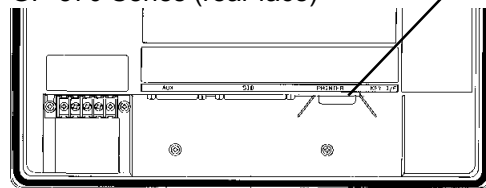

- 1) Connect the 14 pin end of the cable to the GP.

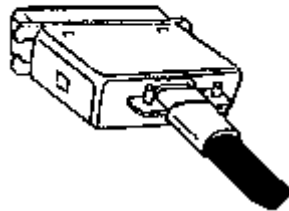

- 2) Secure the cable by squeezing the connector's 2 side pinch-clips until they lock into place.

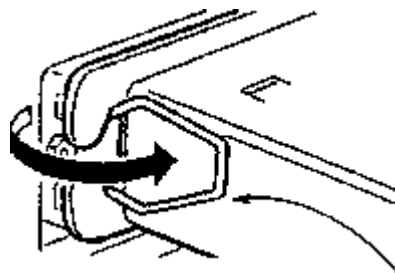

- 3) Connect the cable to your printer, using the same procedures outlined in steps 1 and 2.

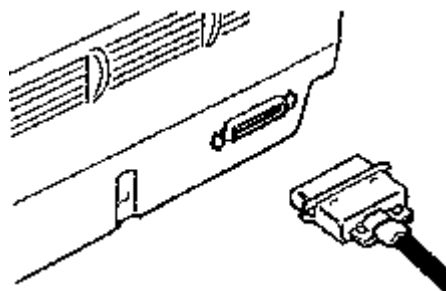

(For the correct printer cable to use with this unit, please contact your nearest Digital representative)

3.4 GP Tool Connector

The GP's Data Transfer Cable or a Bar Code Reader are attached to the GP via the Tool Connector socket.

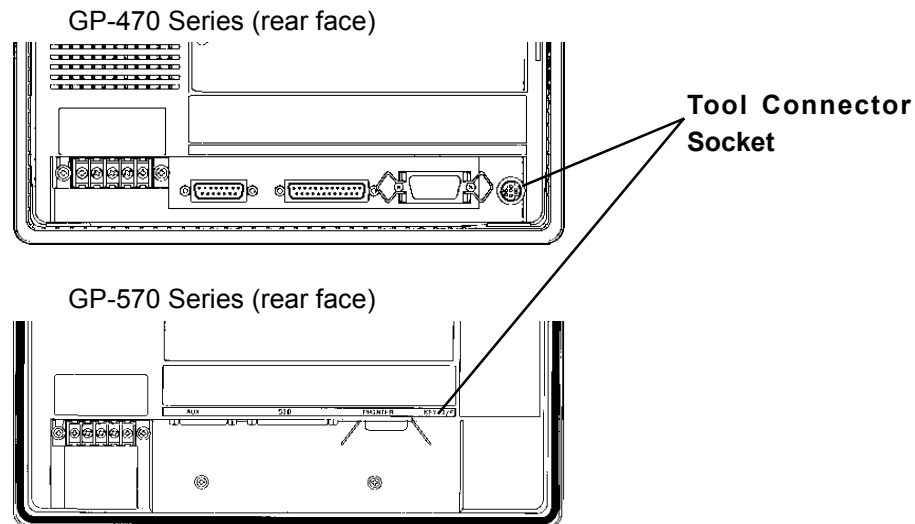

- **Before unplugging any connector(s) from the back of the GP, be sure the GP's power cable is unplugged from the main power supply.**
- **When the Bar Code Reader uses a separate power supply:**
 - Turn the Bar Code Reader ON before turning the GP ON.
 - Turn the GP OFF before turning the Bar Code Reader OFF.

Chapter 4

OFFLINE Mode

1. Entering OFFLINE Mode
2. Main Menu
3. INITIALIZE—Standard Operations
4. SELF-DIAGNOSIS—Standard Operations
5. Transfer Screen Data

4.1 Entering OFFLINE Mode

OFFLINE Mode provides access to the Initialize, Self-Diagnosis, and other features built into the GP. You will need to change the GP to OFFLINE mode before you can use any of these features.



OFFLINE mode is unavailable in a completely new GP until the necessary Screen Data has been transferred from the screen editor software.

To INITIALIZE the setup or run SELF-DIAGNOSIS in the GP unit, transferring to the OFFLINE mode becomes necessary. There are two ways to enter OFFLINE mode; first, just after plugging in the unit's power, and second, by using the Force Reset feature.

1. When Turning the GP's Power ON

Press the top left corner of the GP screen within 10 seconds of plugging in the GP's power cord.

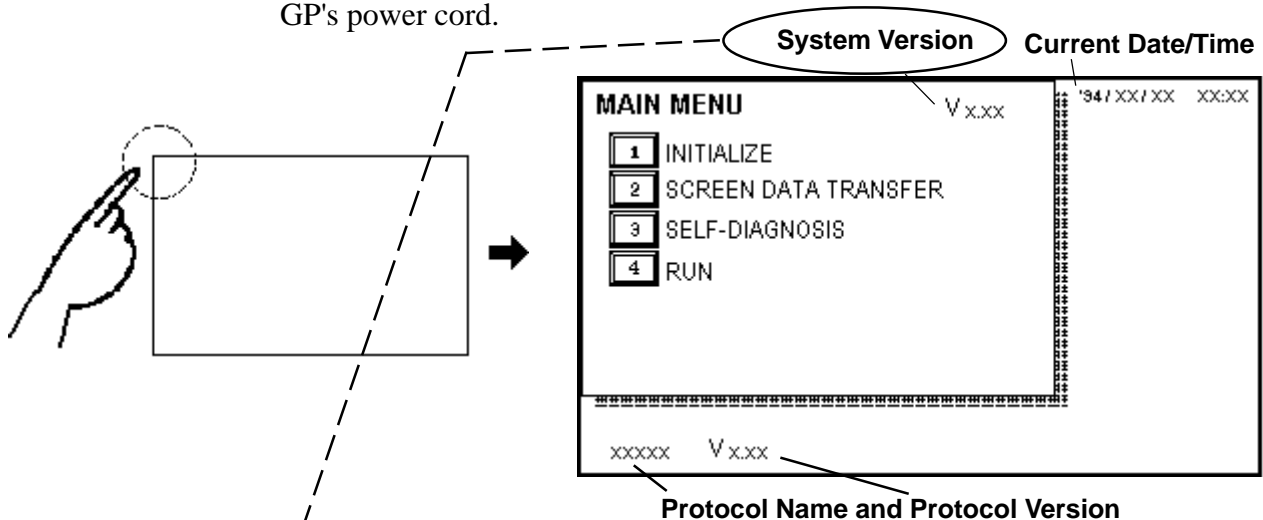

Users wishing to use the Memory Loader (GP070-MU01-O) to upload data must check that the System Version is 1.18 or lower. The Memory Loader II (GP070-LD01-O), however, does not have this limitation.

2. From Forced Reset

From the Forced Reset screen, press the OFFLINE button.

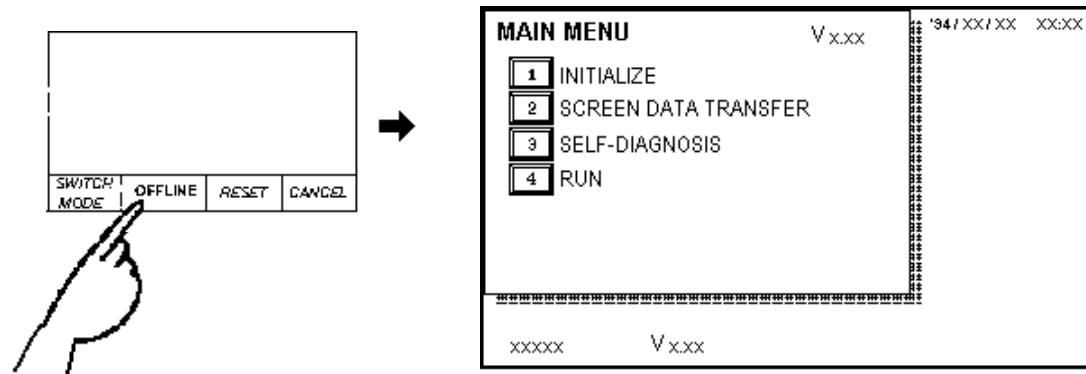

Note: When the GP unit has the Device Monitor function, the following display will appear.

Reference *GP-PRO/PBIII for Windows 95 PLC Connection Manual, Appendix 3 - Device Monitor*

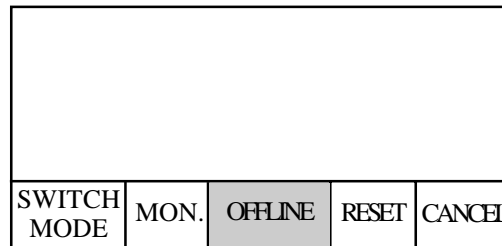

- Note:**
- Only GP-PRO/PBIII for Windows 95 can utilize the Device Monitor function.
 - If a Password has been set in INITIALIZE/ SET UP SYSTEM, before entering the OFFLINE mode, the following screen displays.

Enter the password, then press *Set* to enter OFFLINE mode.

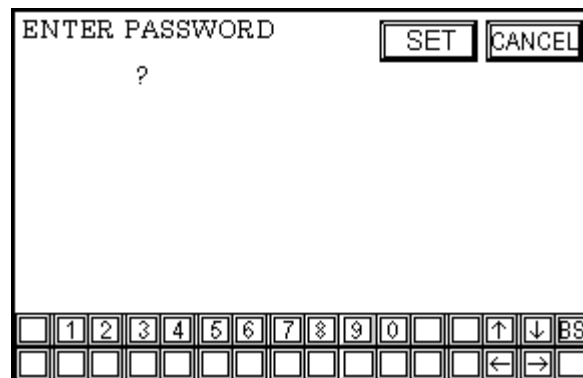

For more about the *Password*, **Reference** *Chapter 5.3, "SYSTEM ENVIRONMENT SETUP"*.

For more information on the *Password input*, **Reference** *Chapter 4.3, "Inputting Numbers"*.

The Main Menu includes the setup items listed below: INITIALIZE, SCREEN DATA TRANSFER, SELF-DIAGNOSIS, and RUN. Each menu item has different setups that must be set to match the corresponding PLC in order for the GP to communicate properly.

Entering the OFFLINE mode displays the screen illustrated below.

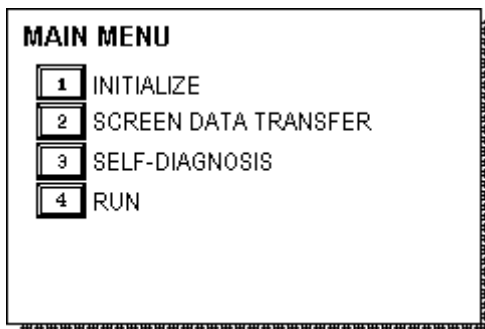

Select the menu item by pressing the corresponding number on the screen.

A short description of each Main Menu item follows.

INITIALIZE

The setup items listed in this menu are necessary to run the GP unit.

SCREEN DATA TRANSFER

Select to transfer screen data to and from the screen editing software.

SELF-DIAGNOSIS

Checks to see if there are any problems with the GP System or Interface (I/F).

RUN

Starts GP Operation.

Reference For more information about INITIALIZE, refer to Chapter 5, "Initialize"; for more information about TRANSFER SCREEN DATA, refer to your *Software Operation Manual*; for more information about SELF-DIAGNOSIS and RUN, refer to Chapter 6, "Run and Errors".

4.3 INITIALIZE—Standard Operation

Selecting A Menu

- Press the menu number to setup.

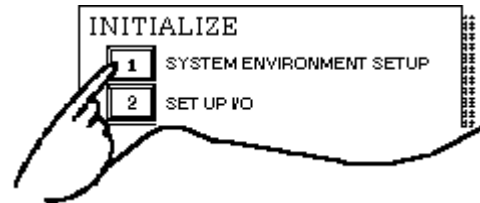

- Press the menu item you wish to setup.

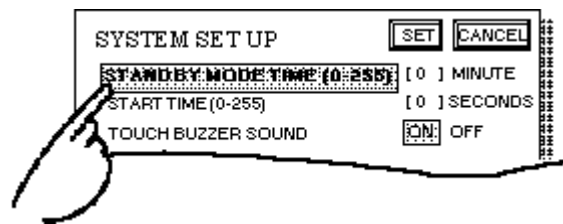

Inputting Numbers

- After selecting an input field by touching it, use the numeric touch keys lined at the bottom of the screen to enter numeric values.

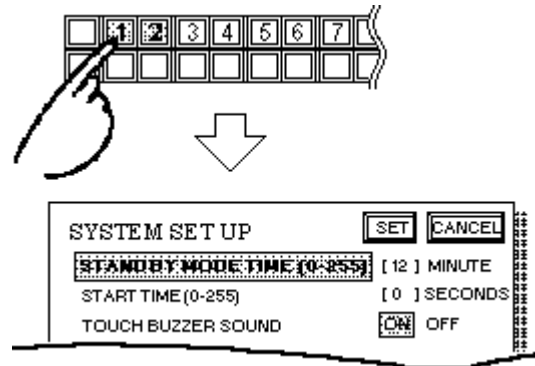

Selecting Setup Conditions

- After selecting the menu item, press the option you would like to setup. The selected item becomes highlighted. In this example, the TOUCH BUZZER SOUND has been set Off.

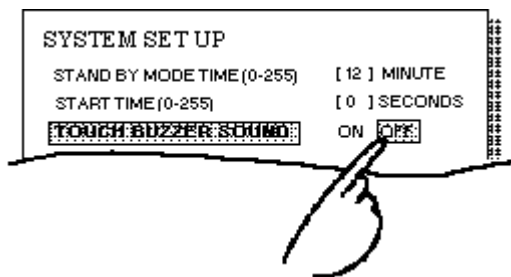

Chapter 4 - OFFLINE Mode

Ending Setup

Press the top-left button, SET.

If you wish to exit the screen without saving the changes, press the CANCEL button.

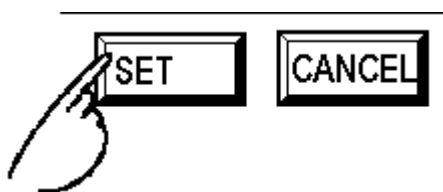

- Press the SET key to write the Setup conditions onto the Internal FEPRM, which may take some time, causing a delay in returning to the previous screen. Therefore, do not touch the screen until the previous menu display returns.
- Press the CANCEL key to *not write* the Setup conditions onto the Internal FEPRM and return to the previous menu.
- When modifying the initial setting data of a GP with backup SRAM built in, all data backed up to that point will be saved if the GP's system version is 1.30 or later. (GP-PRO/PBIII for Windows 95 version 2.0 or later) With earlier GP system versions, all the data will be lost.

Return To Previous Screen

Press the title of the screen you would like to return to.

E.g. To return to the MAIN MENU from the SET UP I/O screen, simply press the MAIN MENU title.

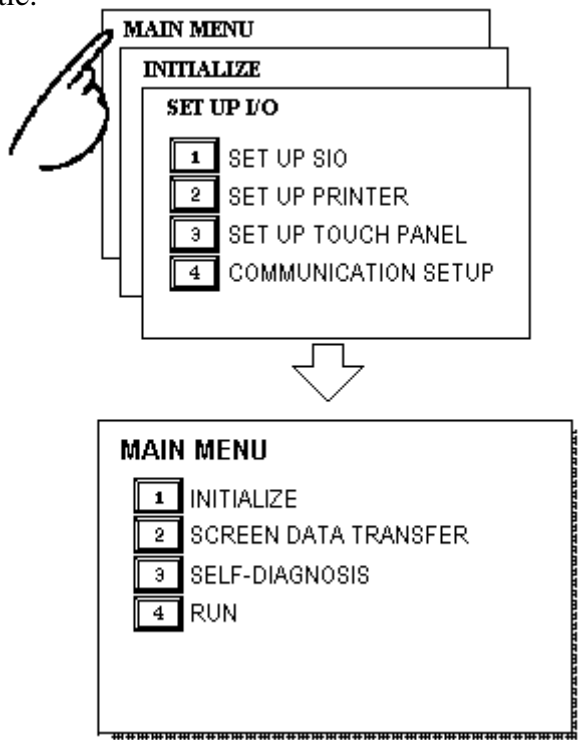

4.4

SELF-DIAGNOSIS—Standard Operation

Selecting A Menu

Press the number of the menu item to diagnose.

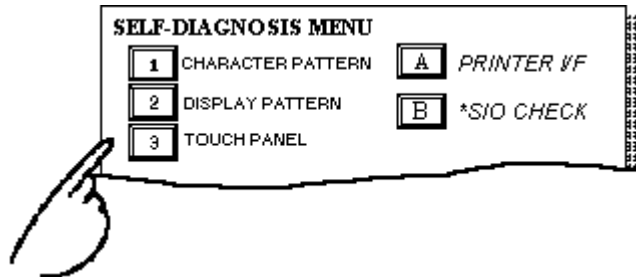

CONFIRM, START, CANCEL Keys

After selecting the Self Diagnosis item, the CONFIRM, START, and CANCEL keys appear at different times at the top of the screen.

E.g.

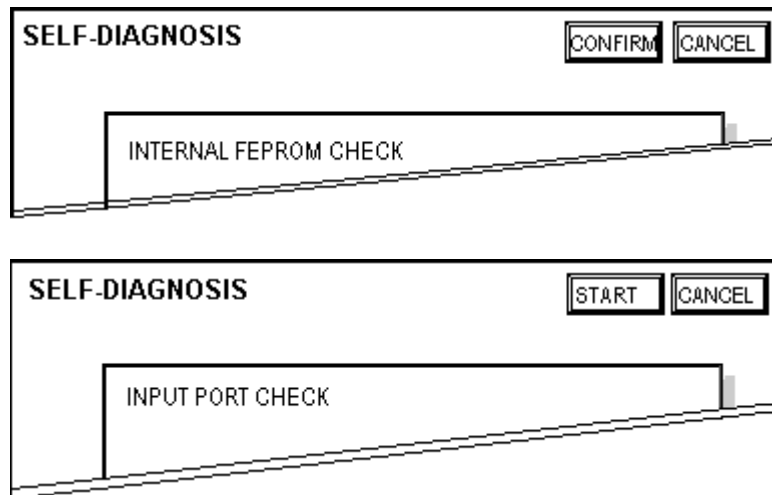

• **CONFIRM Key**

When you see this key, certain preparations—displayed in a message box in the center of the screen—must be made before the Self-Diagnosis can begin. This key ensure you have made these preparations.

Only press CONFIRM when you are sure you have accomplished the tasks set out on the screen.

• **START Key**

When this key is pressed, the Self-Diagnosis begins.

• **CANCEL Key**

When this key is pressed, the Self-Diagnosis command is cancelled, and you return to the SELF-DIAGNOSIS menu.

Chapter 4 - OFFLINE Mode

After Check—To Return To SELF-DIAGNOSIS MENU

When OK displays

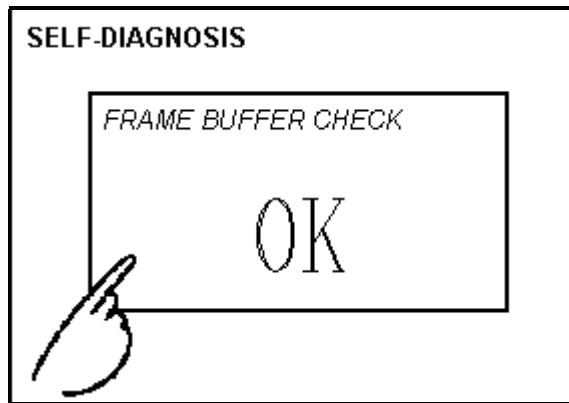

Pressing once anywhere on the display screen returns you to the SELF-DIAGNOSIS MENU.

When an Error Message displays

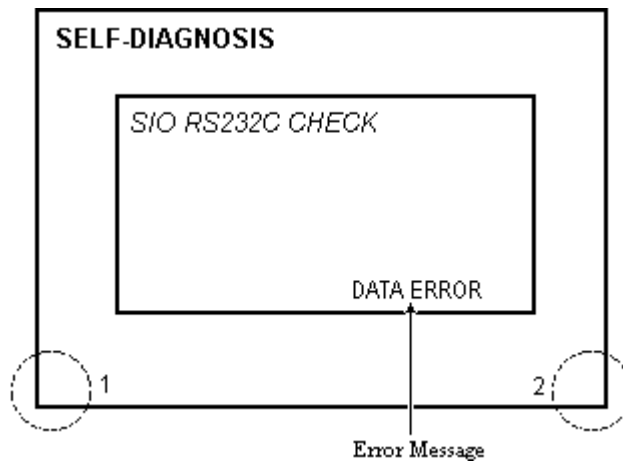

When an error message appears on the display screen, press the bottom two corners of the panel (1, 2) to return to the SELF-DIAGNOSIS MENU.

Return To Main Menu

Press the RETURN Key in the top right corner of the SELF-DIAGNOSIS menu to return to the MAIN MENU.

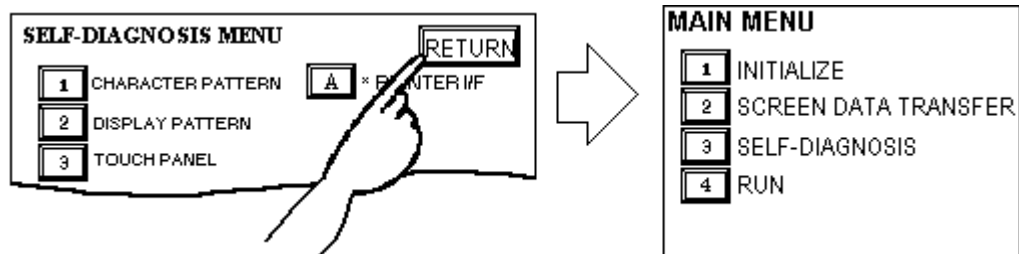

4.5 Transferring Screen Data

The process required to transfer screen data to the GP, or to receive data from the GP, is described here.

Link up the GP's tool connector, located at the back of the GP, with your PC's RS-232C connector using the Downloading cable.

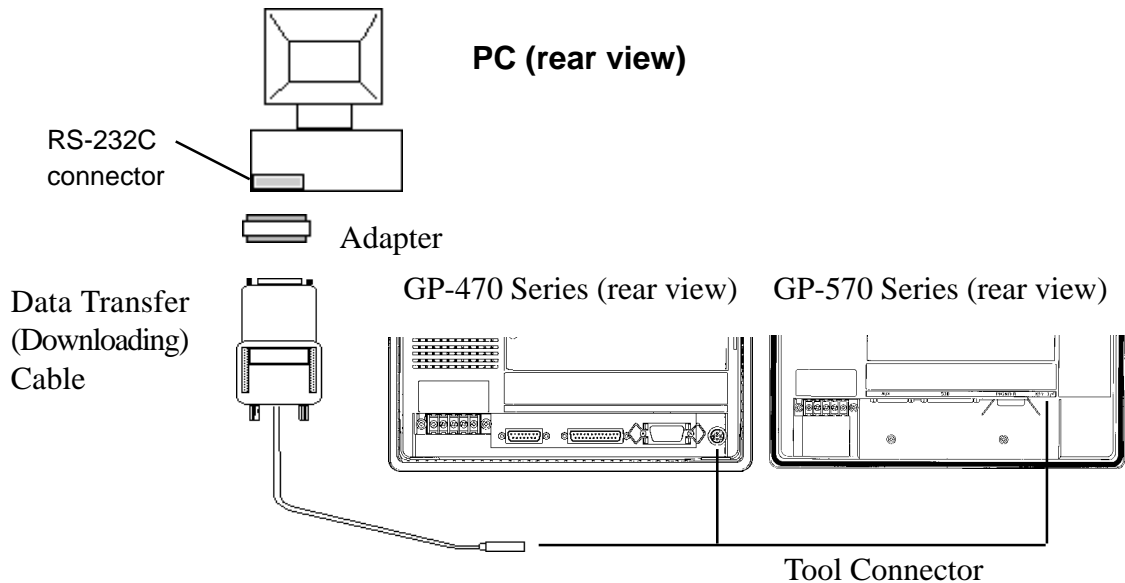

Use an adapter to match the cable with your PC's Serial Port format.



• When using a serial mouse, use a serial port other than that of the mouse.

Before transferring, set the GP to its TRANSFER SCREEN DATA mode. In your screen editing software, setup whether to send screen files to the GP, or to receive files from the GP.

Reference *Software Operation Manual*



• To send screen data to a GP that is currently in OFFLINE mode:

- 1) From the OFFLINE mode's MAIN MENU, press (2) to enter the SCREEN DATA TRANSFER mode. This will allow the GP to receive data.

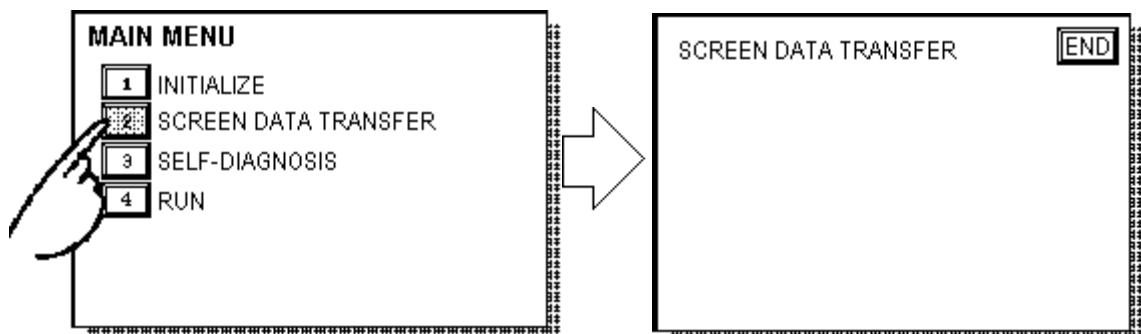

Chapter 4 - OFFLINE Mode

- 2) If desired, touch the END key to stop the transfer. If the Setup ^{*1} is performed during a transfer, the screen designated in the "INITIALIZE / INITIALIZE SCREEN" setting will display. If no setup took place, then the GP will return to the OFFLINE mode's MAIN MENU.



- ***With a GP that is equipped with backup SRAM, when you transfer the information contained in the GP-PRO/PBIII for Windows 95's GP System settings to the GP, all backed up data in the unit will be lost.***

***1** Setup means to download GP's system program and a PLC protocol driver, from a screen editor software, in order to run the GP in a desired environment.



Chapter 5

Initializing the GP

1. Initialization Screen
2. Initialization Items
3. SYSTEM ENVIRONMENT SETUP
4. SET UP I/O
5. PLC SETUP
6. INITIALIZE MEMORY
7. SET UP TIME
8. SET UP SCREEN

5.1 Initialization Screen

Before running the GP unit, various GP setups must be verified; these are listed under the INITIALIZE option in the MAIN MENU.

This chapter explains each of the OFF-line mode's INITIALIZE items. However, there are two types of INITIALIZE settings, for the **1:1** connection and for the **n:1** (multi-link) connection*¹.

The **n:1** mark appears on original menu items concerned only with the n:1 multi-link connection. If there is no mark, the menu item is common to both 1:1 and n:1 connections.

1:1 Process concerning 1 GP connected with 1 PLC.

n:1 Process concerning multiple GP's connected with 1 PLC. The GPs successively pass a *token* (exclusive PLC interaction key) among themselves to communicate with the PLC.



If you transfer your screen design software's System file*², the GP will operate using that data. If the GP System file has been correctly setup and transferred, the entering of INITIALIZE settings become unnecessary. For more information about GP System files:

Reference *Operation Manual, 1.1.2 "Screen Types"*

*1 PLC's that support the n:1 (multi-link) connection are limited.

Reference *PLC Connection Manual*

*2 While "S0" is used in the case of GP-PRO/PBIII, GP-PRO/PBIII for Windows95 uses the term "Settings".

5.2 Initialization Items

The contents of the Initialize setup items listed below are explained in this chapter. To learn about screen operations and numeric input

Reference Chapter 4, "OFFLINE Mode"

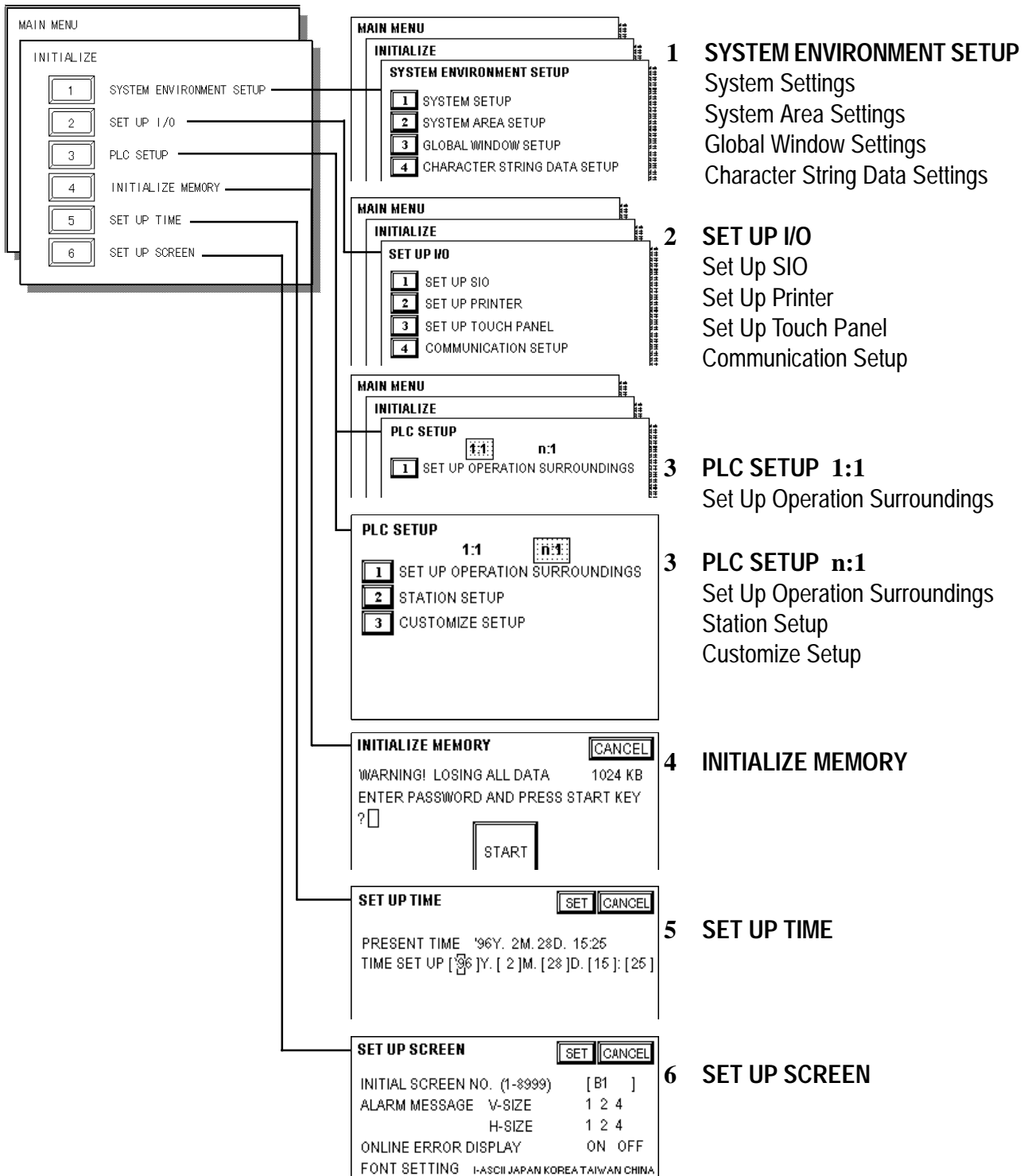

5.3

SYSTEM ENVIRONMENT SETUP

GP environment adjustments are made here. The SYSTEM ENVIRONMENT SETUP includes the SYSTEM SETUP, SYSTEM DATA AREA, GLOBAL WINDOW SETUP, and CHARACTER STRING DATA SETUP.

1. SYSTEM SETUP

SYSTEM SETUP		SET	CANCEL
STAND BY MODE TIME (0-255)	[0]	MINUTE	
START TIME (0-255)	[0]	SECOND	
TOUCH BUZZER SOUND	ON	OFF	
BUZZER TERMINAL OUTPUT	ON	OFF	
PASSWORD SET UP (0-9999)	[0]		
DATA TYPE OF SCREEN NO.	BIN	BCD	

STAND-BY MODE TIME (0-255)

To protect the GP display screen, GP has been setup with a screen saver function that automatically erases the screen when no GP operations have occurred for the time entered here. A 0 entered in this field causes a normal display.

When SYSTEM DATA AREA's (**Reference** *PLC Connection Manual*) SCREEN DISPLAY OFF*1 data is 0000h, and the following operations are *not* performed on the screen for the number of minutes setup, the GP display erases.

- Change Screen
- Touch Screen
- Alarm Display

START TIME (0-255)

This setup determines the start-up time of the GP. Use this setup to adjust the power up sequence so that the GP starts up after the PLC.

TOUCH BUZZER SOUND

Setup whether or not the GP beeps when pressed.

BUZZER TERMINAL OUTPUT

Setup whether or not the BUZZ signal is output from GP's AUX I/F. This option is for an external buzzer.

PASSWORD SETUP(0-9999)

The password setting is used when changing to the Initialize Memory or Initialize (OFF-line mode) Screens. The password (*number*) ensures protection of the GP setups as OFF-line mode will not be entered inadvertently. Enter the optional number of your choice. If you do not wish to use this setup, enter the default 0.

*1 When using the Direct Access or the Memory Link formats, the object address becomes +9 or +12, respectively.

DATA TYPE OF SCREEN NO.

This setup controls whether BIN or BCD format numbers are used when making screen changes. Screen numbers 1~8999 are available when set up in binary format; screen numbers 1~1999 are available when set up in BCD format.

2. SYSTEM AREA SETUP

SYSTEM AREA SETUP data is necessary for the PLC to control the GP, and prepare the PLC internal Data Memory (DM) and Data Register (D)*1. Use this area to prepare the desired SYSTEM DATA AREA items. When using Memory Link format, however, this setting is unnecessary.

SYSTEM AREA SETUP		CONFIRM	CANCEL
1	CURRENT SCREEN NO. (1 WORD)	8	CLOCK DATA (SET) (4 WORDS)
2	ERROR STATUS (1 WORD)	9	CONTROL (1 WORD)
3	CLOCK DATA (CURRENT) (4 WORDS)	A	RESERVED (1 WORD)
4	STATUS (1 WORD)	B	WINDOW CONTROL (1 WORD)
5	RESERVED (1 WORD)	C	WINDOW REG. NO. (1 WORD)
6	CHANGE SCREEN NO. (1 WORD)	D	WINDOW LOCATION (2 WORDS)
7	DISPLAY ON/OFF (1 WORD)	SYSTEM AREA SIZE: WORD(S)	

(Item numbers displayed in reverse mode are selected.)

Reference *PLC Connection Manual*

Press the item number—when the item is highlighted, it has been selected.

System Area Size

This field displays the total number of words of the items selected from the SYSTEM AREA SETUP (Write 1 to 5 and Read 6 to D).

When you press the Confirm key, the SYSTEM AREA CONTENTS screen appears to ratify the selected items



- The setup shown is efficient only when using the Direct Access format.
- The selected System Area items, as displayed on the screen, become the System Data Area.

When these five items, "Current Screen Number", "Error Status", "Clock Data (Current)", "Change Screen Number", and "Display ON/OFF", have been selected, word addresses are assigned to each item, in order, as shown on the next page.

*1 Data Memory (DM) refers to OMRON Co.'s PLC ; Data Register (D) refers to Mitsubishi Electric Co.'s PLC.

Chapter 5 - Initializing the GP

SYSTEM AREA CONTENTS	WORD	BYTE
	+0	+0, 1
	+1	+2, 3
	+2	+4, 5
	+3	+6, 7
	+4	+8, 9
	+5	+10, 11
	+6	+12, 13
	+7	+14, 15
	+8	+16, 17
	+9	+18, 19
	+10	+20, 21
	+11	+22, 23
	+12	+24, 25
	+13	+26, 27
	+14	+28, 29
	+15	+30, 31
	+16	+32, 33
	+17	+34, 35
	+18	+36, 37
	+19	+38, 39



Important

Addresses LS16 to LS19 are fixed since they control the Global Window. These addresses cannot be used for any other purpose.

The System DataArea selection process follows this formula [System Data Start Address + n]. For example, if the System Area Start Address was D00200, and the *Change Screen Number* option had been selected—if you refer to the System Area Contents screen displayed above—because *Change Screen Number*'s address is pegged at +6, its word address would be D00200+6=D00206. For more information on the LS Area 16~19

Reference *Software PLC Connection Manual*, 1.1.2 "LS Area Structure"

3. GLOBAL WINDOW SETUP

The GP unit can display one *Global Window* and two *Local Windows* at any one time. The Global Window is common to all the display screens. The Local Window displays exclusively on the corresponding base screen. The GLOBAL WINDOW SETUP is described here.

GLOBAL WINDOW SETUP		SET	CANCEL																										
GLOBAL WINDOW	USE	DO NOT USE																											
GLOBAL WINDOW ACCESS	DIRECT	INDIRECT																											
DATA FORMAT	BIN	BCD																											
REGISTRATION NO. (1-256)	[]	(DIRECT MODE ONLY)																											
WINDOW LOCATION	X POSITION (← →) []	(DIRECT MODE ONLY)																											
	Y POSITION (← →) []	(DIRECT MODE ONLY)																											
The items in this area are only valid when using the Global Window.																													
<table border="1" style="width: 100%; text-align: center;"> <tr> <td>1</td><td>2</td><td>3</td><td>4</td><td>5</td><td>6</td><td>7</td><td>8</td><td>9</td><td>0</td><td>↑</td><td>↓</td><td>BS</td> </tr> <tr> <td></td><td></td><td></td><td></td><td></td><td></td><td></td><td></td><td></td><td></td><td>←</td><td>→</td><td></td> </tr> </table>				1	2	3	4	5	6	7	8	9	0	↑	↓	BS											←	→	
1	2	3	4	5	6	7	8	9	0	↑	↓	BS																	
										←	→																		

GLOBAL WINDOW

There are two options here: **Use** and **Do Not Use**. If you select **Do Not Use**, ignore the items described below. Selecting **Use** makes these options available.

GLOBAL WINDOW ACCESS

Setup the Global REGISTRATION NO. and the WINDOW LOCATION as *Direct* or *Indirect* values. When set as Direct, the REGISTRATION NO. and WINDOW LOCATION selections are fixed to the values setup here. When set to Indirect, the WINDOW REG. NO. word address, as prepared in the System Area, is variable—which means it can have the REGISTRATION NO. *written* to it—and

as a result, multiple window screens can be used as Global windows. Using this same method, adjust the Global window position, by writing the X,Y coordinates to the SYSTEM AREA's WINDOW LOCATION word addresses.

DATA FORMAT

Setup whether the REGISTRATION NO. and the WINDOW LOCATION values are inputted as BIN or BCD numbers. This field affects only direct values..

REGISTRATION NO. (1-256)

Setup the Window Screen Number used by the Global Window. This field is applicable only when the GLOBAL WINDOW ACCESS is set to Indirect.

WINDOW LOCATION

Setup for the Global WINDOW LOCATION. This field is applicable only when the GLOBAL WINDOW ACCESS is set to Indirect.

4. CHARACTER STRING DATA SETUP

Character String Data ordering varies from manufacturer to manufacturer. Setup the *Character String Data* order here to match the corresponding PLC.

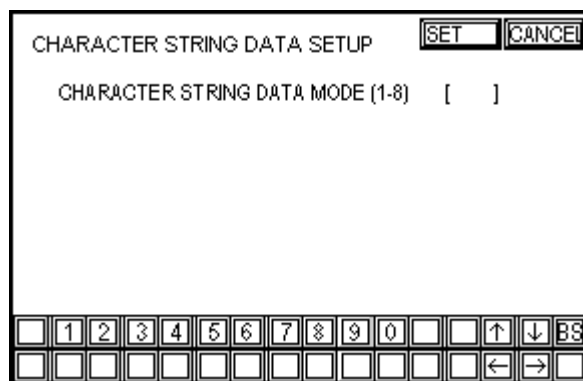

Setup the CHARACTER STRING DATA MODE to match the PLC type. Device type and Tag settings are unavailable.

Find the data storage order for your PLC in the table, next page, and setup the CHARACTER STRING DATA MODE.

- (I) Data Device Storage Order
- (II) Internal Word Byte LH/HL Storage Order
- (III) Internal Double-word Word LH/HL Storage Order

Chapter 5 - Initializing the GP

CHARACTER STRING DATA MODE List

I) Data Device Storage Order	II) Internal Word, Byte LH/HL Storage Order	III) Double-word Internal Word LH/HL Storage Order	Character String Data Mode
Storage from Start data	LH order	LH order	4
		HL order	2
	HL order	LH order	5
		HL order	1
Storage from End Data	LH order	LH order	6
		HL order	7
	HL order	LH order	8
		HL order	3

I) Data Device Storage Order

E.g. Characters A B C D E F G H
 ① ② ③ ④

• Storage from Start Data

①	D100
②	D101
③	D102
④	D103

• Storage from End Data

④	D100
③	D101
②	D102
①	D103

II) Word Byte LH/HL Order

E.g. Characters A B C D
 ① ② ③ ④

• 16 bit Device LH Order

②	①	D100
④	③	D101

• 16 bit Device HL Order

①	②	D100
③	④	D101

• 32 bit Device LH Order

②	①	④	③	D100
---	---	---	---	------

• 32 bit Device HL Order

①	②	③	④	D100
---	---	---	---	------

III) Double-word Word LH/HL Order

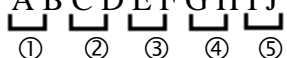
E.g. Characters "A B C D E F G H I J"

• 16 bit Device LH Order

②	D100
①	D101
④	D102
③	D103
⑤	D104

• 16 bit Device HL Order

①	D100
②	D101
③	D102
④	D103
⑤	D104

E.g. Characters "A B C D E F G H I J K L M N O P Q R S T"

• 32 bit Device LH Order

②	①	D100
④	③	D101
⑥	⑤	D102
⑧	⑦	D103
⑩	⑨	D104

• 32 bit Device HL Order

①	②	D100
③	④	D101
⑤	⑥	D102
⑦	⑧	D103
⑨	⑩	D104

Relationship between K-tag Write Character Value and PLC Device

• 16 bit Devices

GP stores the character string from the start, as groups of 2, into 1 PLC Device.

When there are nine characters, they are arranged as shown below.

1 2 3 4 5 6 7 8 9 "





Note: When the characters do not divide into 2 evenly, NULL is added at the end.

• 32 bit Devices

GP stores the character string from the start, as groups of 4, into 1 PLC Device.

When there are nine characters, they are arranged as shown below.

1 2 3 4 5 6 7 8 9 "



Note: When the characters do not divide into 4 evenly, NULL is added.

5.4 SET UP I/O

This section describes the communication setup with the host PLC and the setup for any peripheral equipment. The SET UP I/O menu includes the SET UP SIO, SET UP PRINTER, SET UP TOUCH PANEL, and COMMUNICATION SETUP menus.

1. SET UP SIO

This menu runs the setups related to PLC communication. Match the settings listed below with the SIO setup on the PLC host side.

Reference *PLC Connection Manual 2* -*- 4/5 -*- 4 (Environment Setup Data)

SET UP SIO		SET	CANCEL
COMMUNICATION RATE	2400 4800 9600 19200 38400		
DATA LENGTH	7 8		
STOP BIT	1 2		
PARITY	OFF ODD EVEN		
CONTROL	X-CNTRL ER-CNTRL		
COMMUNICATION FORMAT	RS232C 4 LINE 2 LINE		

COMMUNICATION RATE

The COMMUNICATION RATE (baud rate) is the data communication speed, measured in bits per second (bps), between the GP and PLC. Match the COMMUNICATION RATE values in both the PLC and GP.

DATA LENGTH

For data communications, the DATA LENGTH must be set up as 7-bit or 8-bit data.

STOP BIT

Set up the STOP BIT as either a 1-bit or 2-bit value.

PARITY

Set up whether no parity check, or an odd or even number parity check will take place during communication.

CONTROL

Data flow CONTROL prevents the overflow of data sent back and forth. Select either X-CNTRL or ER-CNTRL.

COMMUNICATION FORMAT

Select one of the following options for the communication format: RS-232C, RS-422 (4 line), or RS-422 (2 line).



When communicating with the Memory Link format using RS-422, select the 4-line option.

2. SET UP PRINTER

SET UP PRINTER

PRINTER TYPE

NEC PR SERIES HP LASERJET SERIES

EPSON ESC/P (HIGH SPEED)

EPSON ESC/P (HIGH QUALITY)

PRINT **GRAY SCALING** COLOR

BLACK /WHITE REVERSE **YES** NO

PRINTER TYPE

Designates the type of printer used with the GP unit.

Use the EPSON ESC/P settings for 24 dot printers, and the HP-LaserJet Series option for PCL4 compatible printers.

PRINT (GP-570 and GP-571 Series units only)

Setup whether the printer outputs in Monochrome or Color.

Each of these pairs, Blue and Green, Cyan and Red, and Purple and Yellow, appears with the same pattern when output in monochrome.



The HP-LaserJet Series does not support GP color printouts. With these printers, always use the GRAY SCALING selection.

BLACK/WHITE REVERSE (GP-570 and GP-571 Series)

This setup reverses the screen colors from white on black (Fg/Bg) to black on white for screen printouts. The screen background on the GP is black, but it is easier to see screen objects on the hardcopy when *Reverse* is ON so the screen prints white.

E.g. When the GP screen background is black and the foreground is white, the printout appears as follows.



Print w/ Reverse ON



Print w/ Reverse OFF



- The FORCE RESET mode cannot be entered while waiting for the GP to start up.
- Entering FORCE RESET is possible even when RUN operations (PLC \longleftrightarrow GP communication) do not occur.

CONTRAST ADJUSTMENT (Only for GP570-SC**)

When this option is set ON, CONTRAST ADJUSTMENTs can be made through touch input.

While pressing the upper right hand corner (1) of the screen, press the upper left corner (2) to enter CONTRAST ADJUSTMENT mode. Press the desired setting and the screen's contrast will change accordingly.

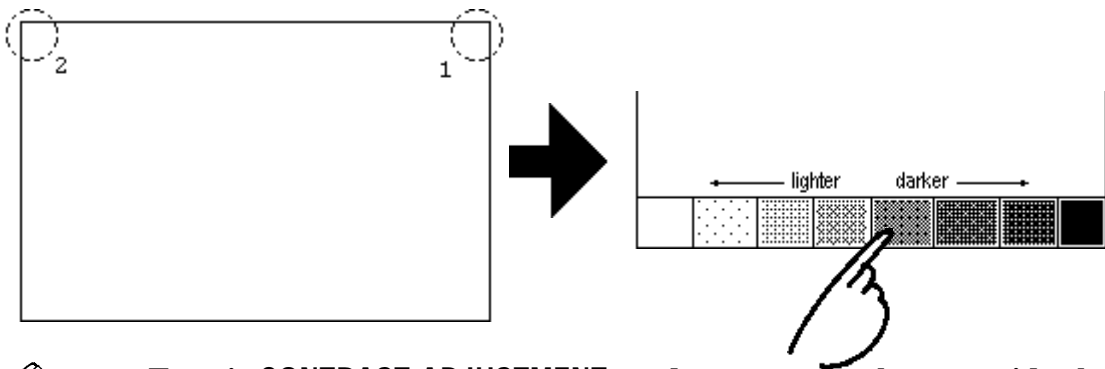

- To exit CONTRAST ADJUSTMENT mode, press anywhere outside the contrast option bar.
- CONTRAST ADJUSTMENT mode cannot be entered while waiting for GP to start up.
- CONTRAST ADJUSTMENTs can be made even in the middle of RUN mode (PLC \longleftrightarrow GP communication).

BRIGHTNESS ADJUSTMENT (Only for GP-470 Series)

When set ON, BRIGHTNESS ADJUSTMENTs can be accomplished through touch input.

Press the bottom left corner (2) of the screen while holding down the bottom right corner (1) to enter BRIGHTNESS ADJUSTMENT mode. Touch the left-side of the bar to brighten the display; touch the right-side of the bar to dim the display.

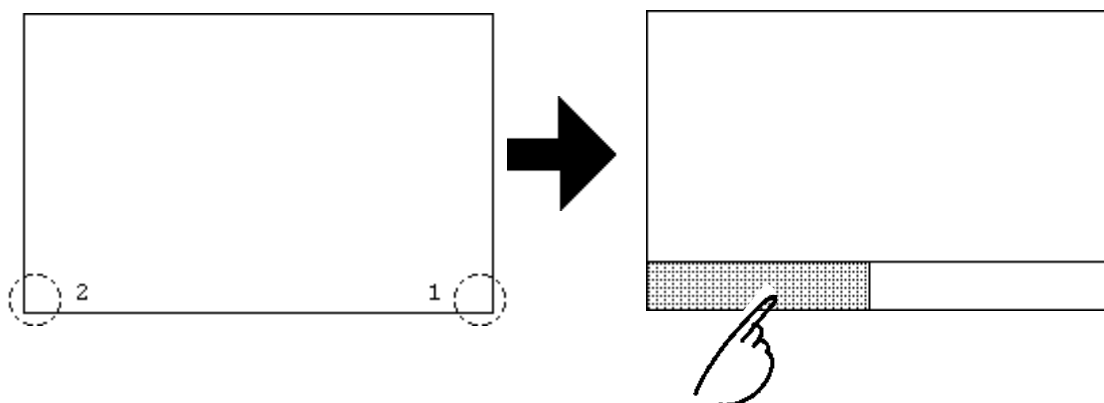

- To end BRIGHTNESS ADJUSTMENT mode, press anywhere outside the bottom of the screen.
- BRIGHTNESS ADJUSTMENT mode cannot be entered while waiting for GP to start up.
- BRIGHTNESS ADJUSTMENTS can be made even during RUN mode (PLC<—>GP communication).

4. COMMUNICATION SETUP

These fields set *when* an error message is reported after a GP<—>PLC communication error is detected. This ensures an error has actually taken place and not just slight breaks in communication or slowness in processing data on one side or the other.

COMMUNICATION SETUP		SET	CANCEL
RECEIVE TIMEOUT (1-127)	[]	SECON	
RETRY COUNT (0-255)	[]		

RECEIVE TIMEOUT

Set up how long the GP unit will wait when there is nothing being sent to it. (This is the *Timeout Time*.) However, if there is no cable connected up, then regardless of the time set up here, the Timeout value is 1 second. The default value is 10 seconds.



When a value of over 30 seconds is set here, and a screen is transferred from the PC while a PLC Communication Time error has occurred, an error may also appear on the PC side.

RETRY COUNT

Set up the number of times the GP will try to send data when a Communication error occurs. Even if the data is resent, unless the transfer is successful, an error message will be displayed on the GP. The default value is 2 times.

5.5 PLC SETUP

Setup the System Area and the Unit number in this screen. Because 1:1 and n:1 GP connections change the setup contents, check it before running any setups.



Note: With the GP-PRO/PBIII for Windows “Simulation” feature, the GP’s “Setup Operation Surroundings” area cannot be used.

1. SET UP OPERATION SURROUNDINGS (1:1)

Setup the PLC System Data Area and the Unit Number here.



Note: This setup is only necessary when using the Direct Access format.

SET UP OPERATION SURROUNDINGS		SET	CANCEL
STARTING ADDRESS OF SYSTEM DATA AREA	[0]		
UNIT NO.	[0]		
SYSTEM AREA READING AREA SIZE (0-256)	[0]		

STARTING ADDRESS OF SYSTEM DATA AREA

Setup the PLC's Data Register (D), Data Memory (DM), etc. allotted by the STARTING ADDRESS OF SYSTEM DATA AREA.

UNIT NO.

Set up the PLC UNIT number here. Make sure it matches the one set up in the PLC.

SYSTEM AREA—READING AREA SIZE (0-256)

When using a Block Display Trend Graph, setup the Reading Area Size (in word units) to match the Trend Graph's data size. Setup when you wish to allocate the Reading Area in the PLC Data Register (D), or Data Memory (DM).



Important

- **If you are not using the Reading Area, leave the 0 default values intact. High Speed Communications can be secured as a result.**
- **When using Hitachi's HIDIC-S10 a Series, an extra item titled "Extended Memory Address (HIDIC) [000000]" is added to the above screen display. Values accepted by the extended memory start address are 0 (memory not extended), and 100000~1FF000.**



Note:

- **When using Matsushita Electric's NEWNET-FP, an extra item titled "Monitor Register" is added to the screen display. If using 2 or more CCU's (communication unit) as in the following diagram, and a GP is connected to each CCU, select 1:1 connection and setup the Monitor Register as "None".**

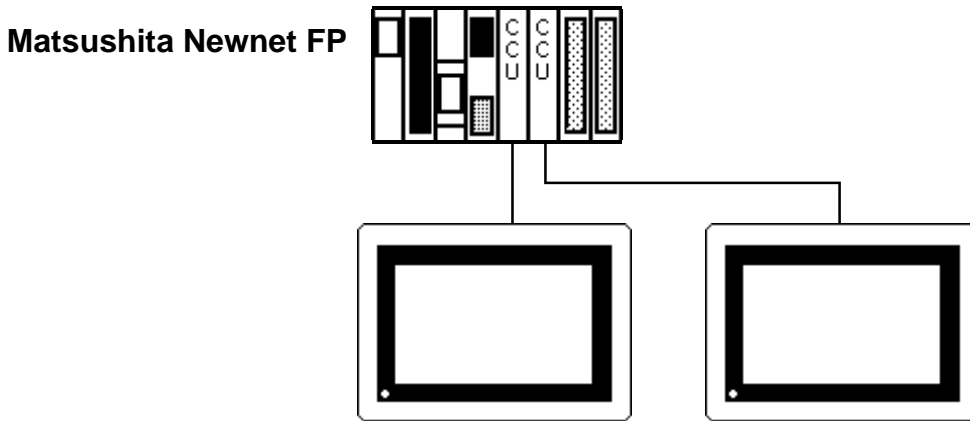

Note: • When connecting only one GP (to a PLC), be sure to see the Monitor Register to ON.

2. SET UP OPERATION SURROUNDINGS (n:1)

This is the setup for the PLC System Data Area and the Unit Number for an n:1 (multi-link) PLC connection.

For more about the SYSTEM DATA AREA with the n:1 (multi-link) connection,

Reference: *PLC Connection Manual*

Note: This setup is only necessary when using the Direct Access format.

SET UP OPERATION SURROUNDINGS		SET	CANCEL
STARTING ADDRESS OF SYSTEM DATA AREA	[0]		
UNIT NO.	[0]		
SYSTEM AREA READING AREA SIZE (0-256)	[0]		

STARTING ADDRESS OF SYSTEM DATA AREA

Setup the PLC's Data Register (D), Data Memory (DM), etc. allotted by the STARTING ADDRESS OF SYSTEM DATA AREA.

UNIT NO.

Set up the PLC UNIT number here. Make sure it matches the one set up in the PLC.

SYSTEM AREA—READING AREA SIZE (0-256)

When using a Block Display Trend Graph, setup the Reading Area Size (in word units) to match the Trend Graph's data size. Setup when you wish to allocate the Reading Area in the PLC Data Register (D), or Data Memory (DM).



• **If you are not using the Reading Area, leave the 0 default values unchanged. This will allow High Speed data transmission to be performed.**

3. STATION SETUP (n:1)

The STATION SETUP, necessary for the n:1 (multi-link) setup, checks whether correct communications run with the connected GP System configuration.

STATION SETUP		SET	CANCEL
NETWORK INFORMATION ADDRESS	[0]		
STATION NO.	[0]		

NETWORK INFORMATION ADDRESS

In the n:1 (multi-link) connection, the Network Information uses 2 words in its correspondences. These two (2) words consist of a Connection List and a Validation List (described later in this section). These areas are allocated in the PLC's Data Register (D) or Data Memory (DM).

PLC Data Register

+0	CONNECTION LIST	PLC-->GP
+1	VALIDATION LIST	GP-->PLC



Important

In the NETWORK INFORMATION ADDRESS, setup the same address to all the GP's connected to the same link unit. Also, when there are 2 ports in the connected link unit, do not make them the same address.

• Connection List

The word address for the Connection List sets up the number of GP's connected to the PLC, which must be registered beforehand on the PLC side. When these GP's are connected to the PLC, the corresponding PLC bit numbers for the particular GP Stations (see below) turn ON.



Note:

When the GP is connected to the PLC, and the option of GP only correspondence ends and Offline mode is entered, the GP Station Number turns the corresponding PLC bit OFF.

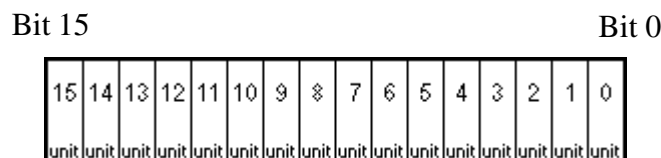

Chapter 5 - Initializing the GP

For example, when these 4 GP units—bit 0, bit 2, bit 3, bit 5—are connected, 002D (h) is written here.

Connection List

0	0	0	0	0	0	0	0	0	0	0	1	0	1	1	0	1
---	---	---	---	---	---	---	---	---	---	---	---	---	---	---	---	---

 002D (h)



- **Be certain to enter these settings before running the GP.**
- **Turn all bits not connected to the GP OFF.**

• Verification List

This area responds to the correspondence from each connected GP. In the Verification List, when the same bit numbers as the Connection List turn ON, data communication can be performed. Next, the Station Numbers of the communicating GPs turn their corresponding PLC bit numbers ON.

Bit 15	Bit 0																																														
<table border="1" style="width: 100%; border-collapse: collapse; text-align: center;"> <tr> <td>15</td><td>14</td><td>13</td><td>12</td><td>11</td><td>10</td><td>9</td><td>8</td><td>7</td><td>6</td><td>5</td><td>4</td><td>3</td><td>2</td><td>1</td><td>0</td> </tr> <tr> <td>unit</td><td>unit</td><td>unit</td><td>unit</td><td>unit</td><td>unit</td><td>unit</td><td>unit</td><td>unit</td><td>unit</td><td>unit</td><td>unit</td><td>unit</td><td>unit</td><td>unit</td><td>unit</td> </tr> </table>																15	14	13	12	11	10	9	8	7	6	5	4	3	2	1	0	unit	unit	unit	unit	unit	unit	unit	unit	unit	unit	unit	unit	unit	unit	unit	unit
15	14	13	12	11	10	9	8	7	6	5	4	3	2	1	0																																
unit	unit	unit	unit	unit	unit	unit	unit	unit	unit	unit	unit	unit	unit	unit	unit																																

If the settings used for the GP and PLC agree, the Connection List values are written to the Verification List.

For example, the value 002D (h) in the Connection List, setup here as the 0 bit, 2 bit, 3 bit, and 5 bit, will then be written to the Verification List.

Connection List

0	0	0	0	0	0	0	0	0	0	0	1	0	1	1	0	1
---	---	---	---	---	---	---	---	---	---	---	---	---	---	---	---	---

 002D (h)

Verification List

0	0	0	0	0	0	0	0	0	0	0	1	0	1	1	0	1
---	---	---	---	---	---	---	---	---	---	---	---	---	---	---	---	---

 002D (h)



- **When the Connection List and Verification List settings do not match, a COMMUNICATION ERROR will occur.**
- **When changing the connected devices, first turn all the bits OFF.**
- **Even if the GP is connected, if the Connection List data is turned OFF, data transfer cannot occur, and an error will not display.**

STATION NO.

This is the setting for the GP Station Number mentioned above. The setup range is from 0 to 15, and the only restriction is that the GP STATION NO.s used must be unique in the system. If STATION NO.'s are repeated, a COMMUNICATION ERROR occurs.



- **The STATION NO. is the unique number allocated to each GP used. This number is not related to the Link Unit Machine number.**

4. CUSTOMIZE SETUP

The Customize function adjusts the n:1 (multi-link) communication method to make it more effective. For data transfer to be performed efficiently, designate either Operation or Display priority on your GP. This setting can help to improve your GP's communication response speed.

CUSTOMIZE SETUP		SET	CANCEL
PLC PRIORITY	DISPLAY	OPE.	
GP TOUCH MONOPOLIZE	ON	OFF	
MONOPOLIZE TIME (0-2550s)	[]	*10s	

PLC PRIORITY

According to how the GP is used, select either Operation priority (OPE.) or Display priority.

- Display

Setup the GP to this option when using the GP mainly as a monitor screen. The GP will command a higher display speed as a result; however, the response time for the touch panel's operations will slow.

- Operation

Setup the GP to this option when using the GP mainly as an operation panel. As a result, the GP will command better touch panel numeric input and switch response times.

Leaving the GP in this mode does not influence the touch panel operation response time of the rest of the GP's very much; however, the screen display refresh cycle will slow down



- **The standard arrangement uses the same settings with all connected GP's.**
- **To increase the display speed, restrict the address setup to consecutive addresses wherever possible. And make bit addresses consecutive to the word unit.**

- Speed Difference between Display Priority and Operation Priority

When using the Mitsubishi Electric Corp. A3A PLC, with a scan time of 20ms and consecutive addresses (80 words not included in the System Area), the difference in reading speed is as shown in the following graphs.

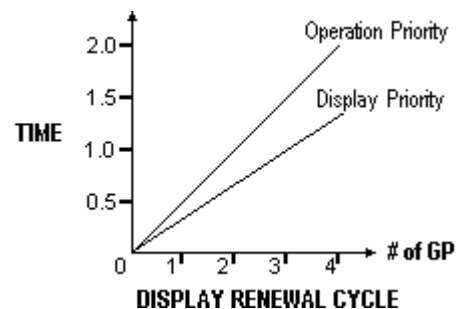
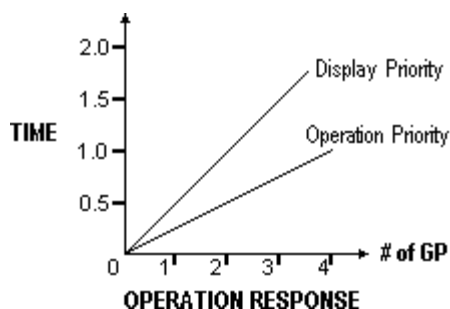

GP TOUCH MONOPOLIZE

The monopolizing of touch panel use can be set ON or OFF. When you want to use the PLC exclusively (**Reference** *PLC Connection Manual*) with a Momentary operation setup on the touch panel, turn GP TOUCH MONOPOLIZE ON.

When this setup is ON, the touch panel uses the PLC exclusively whenever the momentary operation setup on the panel is pressed. In this way, you can use the inching operation with a momentary switch. When you stop pressing the panel, exclusive use ends.

MONOPOLIZE TIME (0 to 2550s)

This field controls the length of time for the monopolize process when no other touch panel operations are performed. The Monopolize process begins when the System Data Area's 7th bit of word address LS14 turns ON, and ends either when the bit turns OFF, or when the time set here passes.



- **Pressing the touch panel in the middle of the monopolize process interrupts the MONOPOLIZE TIME function, ending exclusive use.**
- **When MONOPOLIZE TIME is set to 0, the monopolize function does not end automatically.**

For more about the contents of System Data Area LS6 (status) and LS14 (control)

Reference *PLC Connection Manual*

5.6 INITIALIZE INTERNAL MEMORY



This command erases all the GP screen data.

- **You cannot cancel the Initialization procedure after pressing the Start key.**
- **When modifying the initial setting data of a GP with backup SRAM built in, all data backed up to that point will be saved if the GP's system version is 1.30 or later. (GP-PRO/PBIII for Windows 95 version 2.0 or later) With earlier GP system versions, all data will be lost.**
- **Initialization does not erase the SYSTEM SET UP, the SIO protocol, or the internal clock settings.**

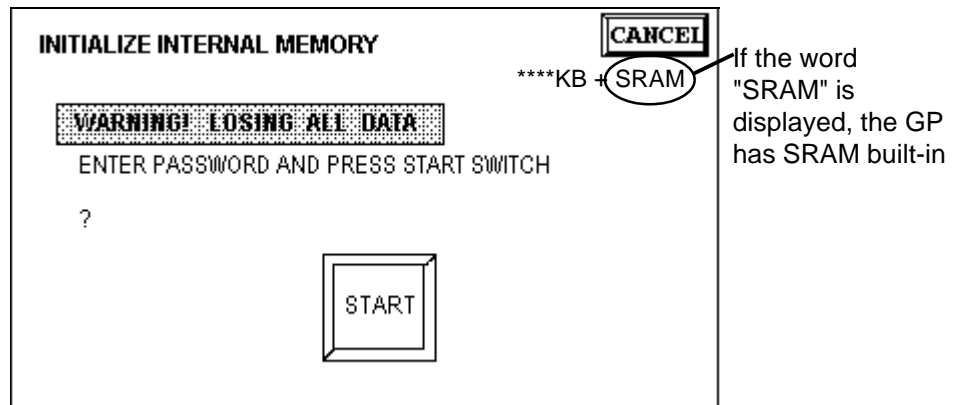

To initialize the GP internal memory, enter the common password **1101**, or the password entered in the SYSTEM SET UP screen.

Reference Chapter 4, "Input Number"



The time required for Initialization is between 10 and 20 seconds.

5.7 SET UP TIME

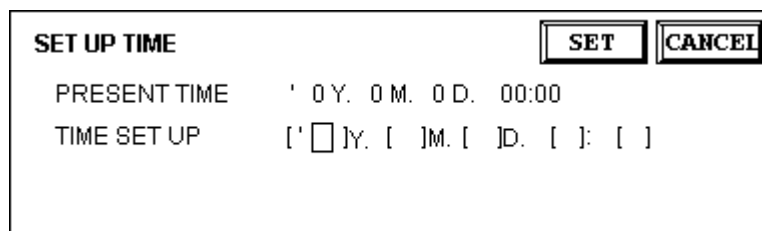

Set up the GP's internal clock.

TIME SET UP

Enter date and time corrections to the date and time displayed in the PRESENT TIME.

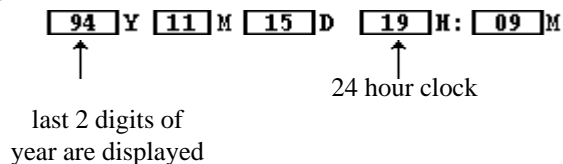



The time displayed on the screen using the Time Display function is not 100% accurate. At room temperature, the GP internal clock has an accuracy of +/- 65 seconds/month. The surrounding temperature and age of the unit can decrease its accuracy up to +90 to -380 seconds/month. However, the screen Time display is in minute intervals, so this error may not be a factor.

5.8

SET UP SCREEN

The initial screen display upon powering up, the character size when in RUN mode, and other related items are setup here.

SET UP SCREEN		SET	CANCEL
INITIAL SCREEN NO. (1-8999)	[B 1]		
ALARM MESSAGE V SIZE	1 2 4		
H SIZE	1 2 4		
ONLINE ERROR DISPLAY	ON OFF		
FONT SETTING	ASCII JAPAN KOREA TAIWAN CHINA		
KANJI FONT QUALITY	STANDARD HIGH(1) HIGH(1,2)		

INITIAL SCREEN NO.

Set up the screen file number that will display first upon powering up. If the BIN option for DATA TYPE OF SCREEN NO in SYSTEM SET UP had been selected, enter a number between 1~8999. Or, if BCD was the option set up, then input a number between 1~1999.

ALARM MESSAGE

Set up the character size of the ALARM MESSAGE when the Alarm Bulletin is activated.

1

Height=1; Width=1
16×8 pixels

2

Height=2; Width=2
32×16 pixels

4

Height=4; Width=4
64×32 pixels

ONLINE ERROR DISPLAY

Set up whether or not error messages display during RUN mode.

FONT SETTING

Select the character font that displays during RUN mode.

KANJI FONT QUALITY

◆When [FONT SETTING] is set to [JAPAN]

Full sized characters:

[STANDARD] : Full sized 16-dot characters display. When enlarged, this font will remain a 16-dot character. (Compatible with GP-*30 series units.)

[HIGH]: Any character which is Level 1 JIS Kanji Code standard larger than 2 x 2 will display as a 32-dot character. Level 2 JIS Kanji Code standard characters, no matter what the current font setting is, will always display using 16 dots.(Compatible with GP-*50 and GP-*70 series units.)

[1,2]: Level 1 or 2 JIS Kanji Code standard characters that are larger than 2 x 2, will display as 32-dot characters.

◆When [FONT SETTING] is set to any other type

A full sized character (except Alphabets) is displayed with 16-dot font, even when it is displayed with an enlarged size. Half sized characters are displayed as:

[STANDARD] : Half sized 16-dot characters display. When enlarged, this font will stay as 16-dot character. (Compatible with GP-*30 series units.)

[HIGH]: Alphabets and numerals (exceptions not included) will display as high quality font-character.

[1,2]: Alphabets and numerals (exceptions not included) will display as high quality font-character.

The [HIGH] selection is factory set.

Chapter 6

GP RUN and Errors

1. RUN Mode
2. Troubleshooting
3. SELF-DIAGNOSIS

This chapter describes the GP RUN mode and problem solving processes.

6.1 RUN Mode

There are two ways of entering RUN mode, from powering up and from OFFLINE mode.

1. After Powering Up the GP

First, connect the GP power cable. After the unit has powered up, the START TIME value—set up in INITIALIZE/ SYSTEM SET UP—determines how long the display, illustrated below, appears, until it gives way to the screen number setup in the INITIALIZE/ SET UP SCREEN menu. However, if a screen has not been designated, or if the screen set up does not exist, then the display below will remain.

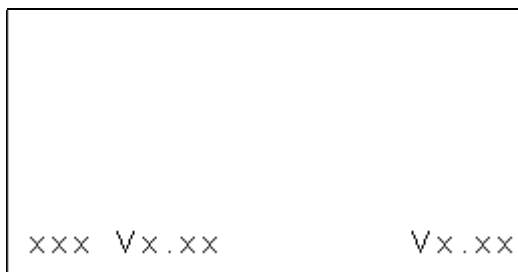

2. Via OFFLINE Mode

Press the OFFLINE mode MAIN MENU item number 4, RUN. The INITIALIZE/ SET UP SCREEN option determines the first screen that appears in RUN mode, thereby beginning communication with the PLC. However, if a screen has not been set up, or if the screen set up does not exist, then the display above remains.

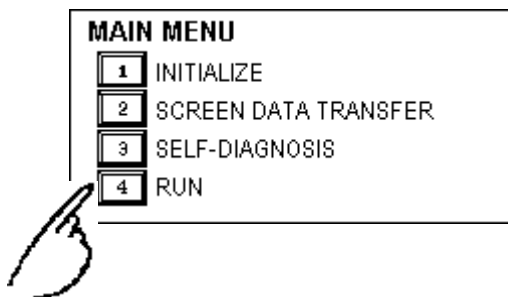



- To enter OFFLINE Mode, simply touch the top left corner of the GP's screen within 10 seconds after connecting the GP's power cord.

E.g. After powering up the GP, the initial screen that appears is equipped with a built-in (invisible) switch in the top left corner. Touch this switch to change the GP from RUN to OFFLINE mode.

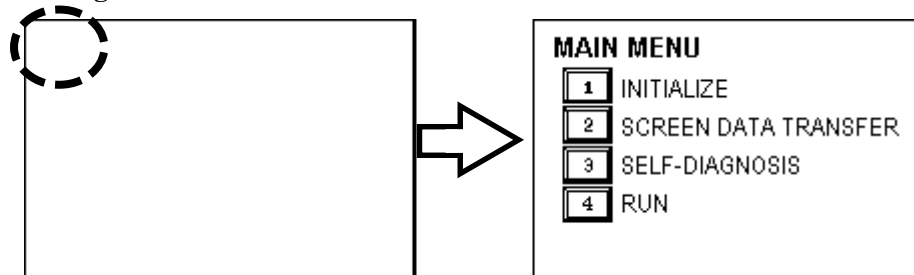

The user can, if desired, create and place a switch-like object ("Go to Main Menu", for example) in their first screen's top left corner to help them to remember this feature)

6.2 Troubleshooting

This section describes how to find and resolve problems that may occur on the GP. If there is a problem on the PLC side, refer to the corresponding PLC manual.

1. Possible Types of Trouble

Shown below are some problems that may occur while using this unit.

No Display

The screen will not display even when the unit is powered On. Also, during RUN mode, the screen disappears.

No GP/Host Communication

The GP unit cannot extract data from the host. An error message may appear on the screen as a result. For more about error messages, refer to the section in this chapter titled, "Error Messages".

Touch Panel Does Not Respond

The touch panel does not react when pressed, or the reaction time is very slow.

OFFLINE displays During RUN Mode

For the first three problems, see the flowcharts listed on the following pages. For the last problem, a SYSTEM ERROR may have developed while displaying the OFFLINE mode screen.

Reference Chapter 6-4-2 Error Message Details



GP Operation Cautions:

- To prevent an electric shock, confirm that the GP's power cord is not plugged in to the main power before attaching the cord's power terminals to the GP.
- Be sure to use gloves when changing the backlight, since there is the possibility of receiving an electric shock or being burned.



- The following section assumes that the GP is the cause of any problems, not the host. When the host (PLC) is the problem, refer to that maker's corresponding PLC manual.

2. No Display

Follow the flowchart below when the screen does not display when powering up, or the screen turns OFF by itself during RUN mode, to find an appropriate solution.

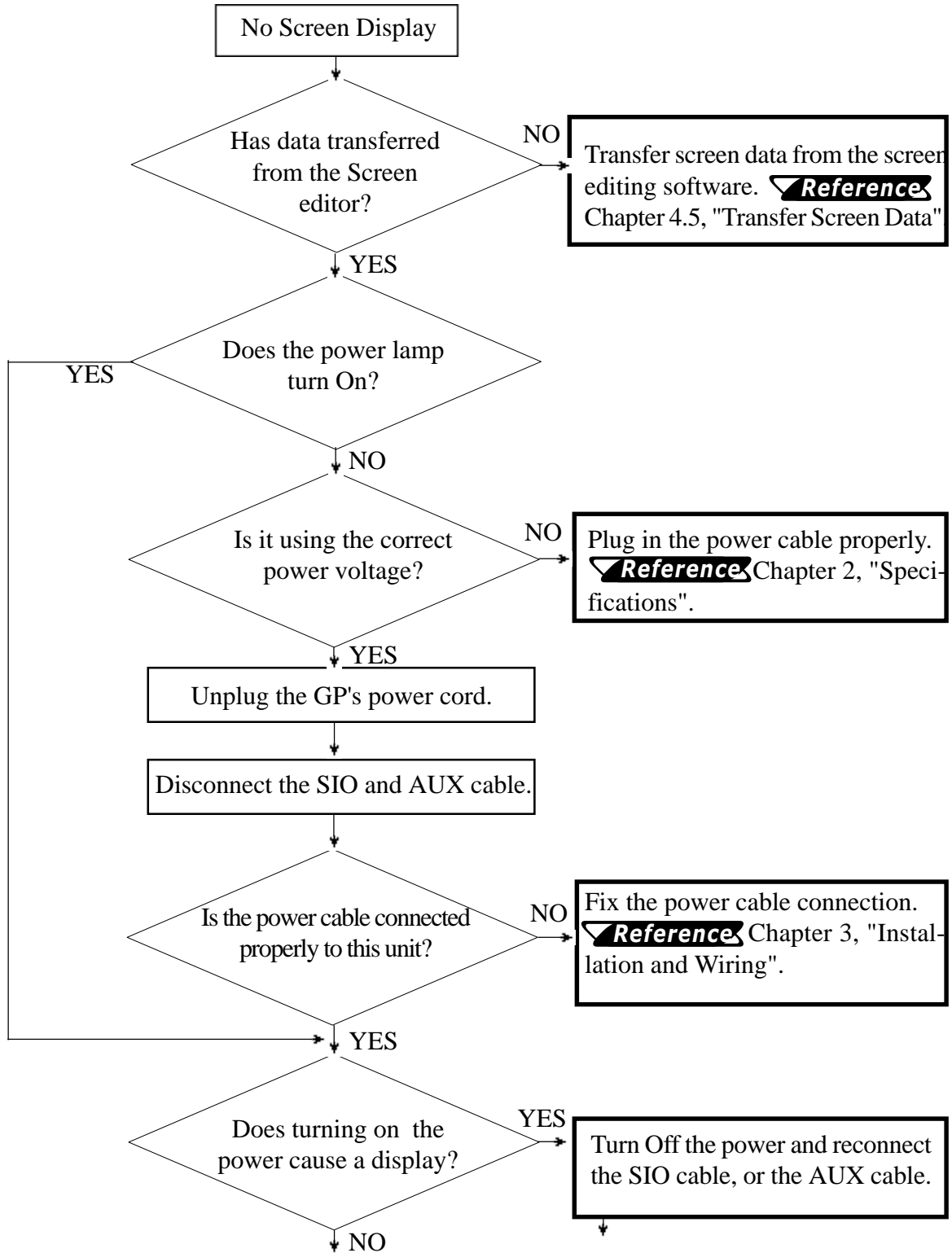

Chapter 6 - Run & Errors

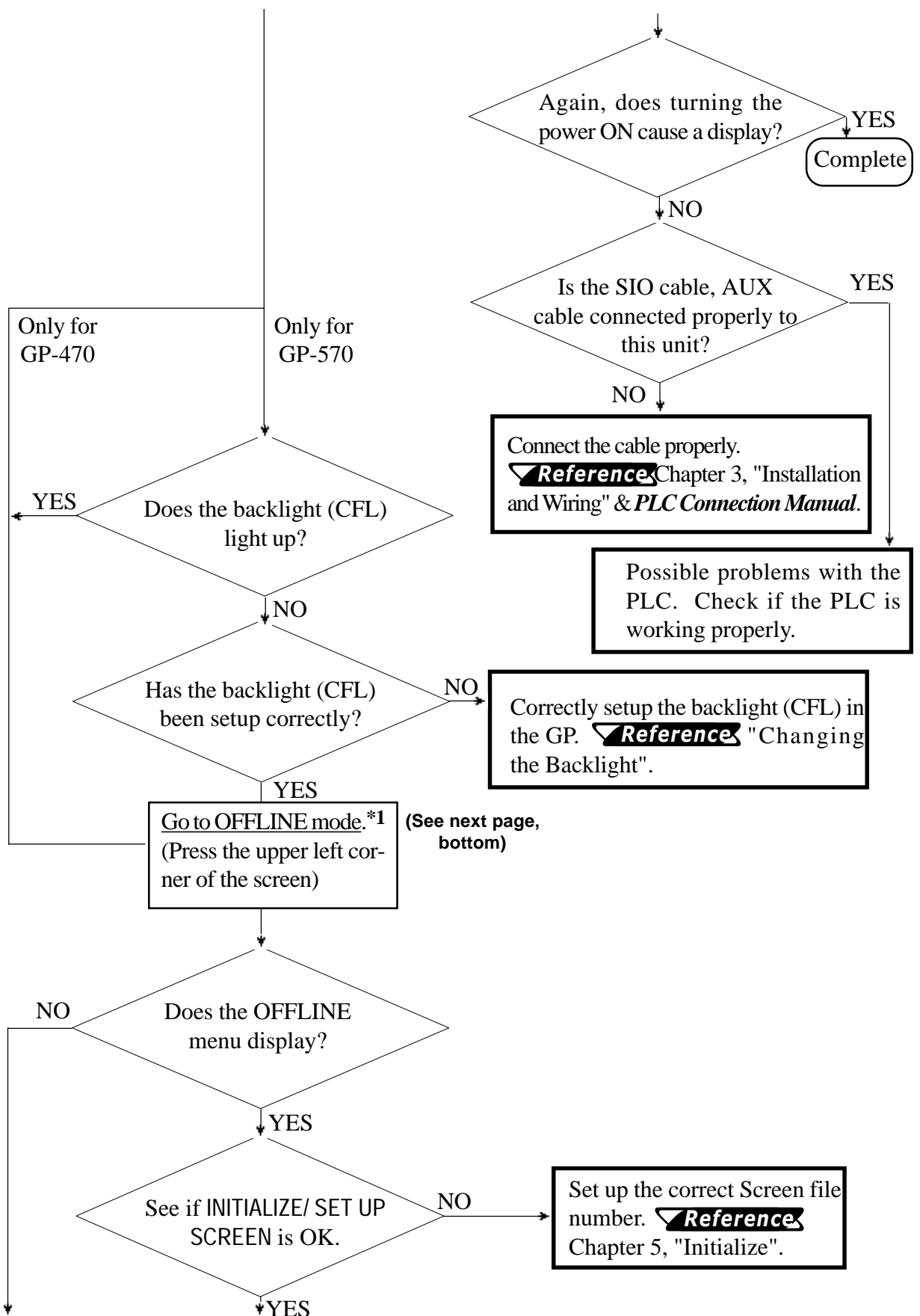

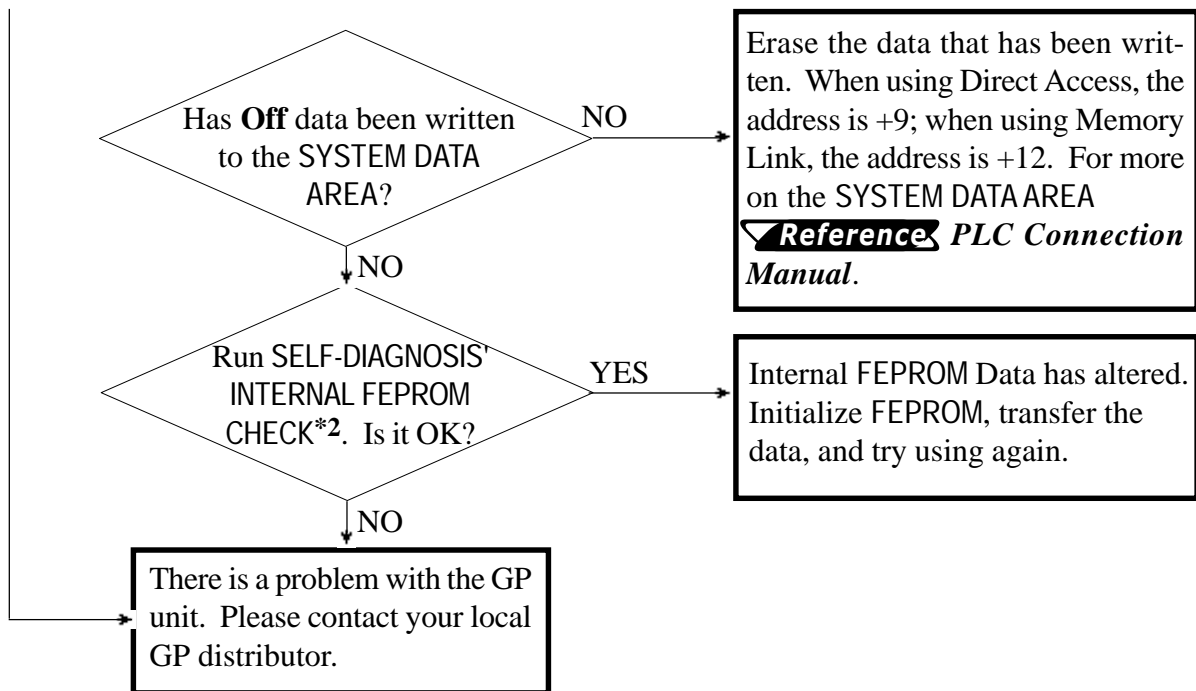

(from previous page) *1 To make the OFFLINE screen appear, turn the power Off, then back On, and press the upper left corner of the screen within 10 seconds.

*2 When you run the FEPRM CHECK in SELF-DIAGNOSIS, all the screen data gets erased. Be sure to make a backup of all the screens.

Chapter 6 - Run & Errors

3. No GP/Host Communication

When the GP will not communicate with the host PLC, follow the flowchart below to find both the cause of the problem and a suitable response.

Or, if an error message displays on the screen, check the error code (refer to the *Error Message* section in this chapter) to find the appropriate solution.

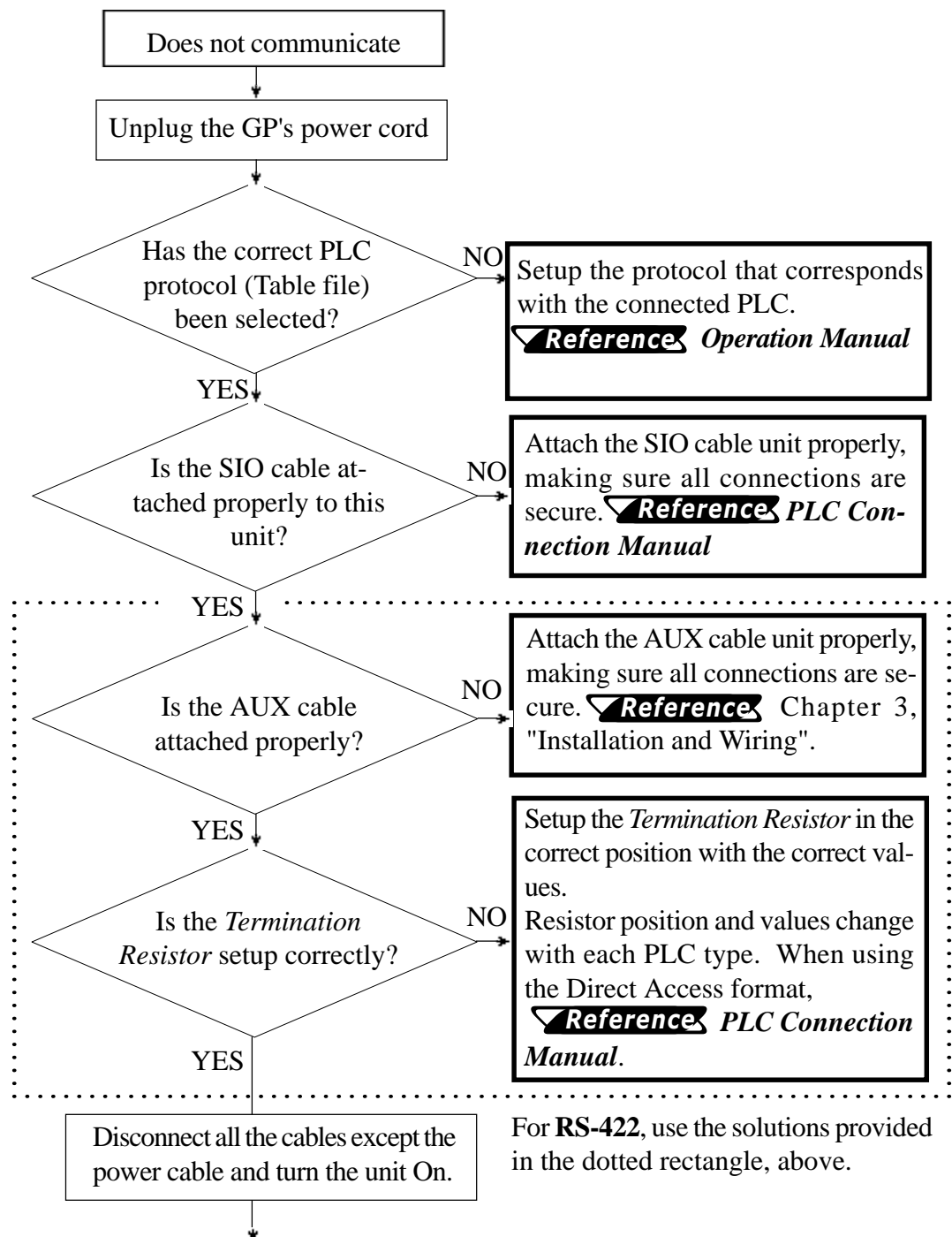

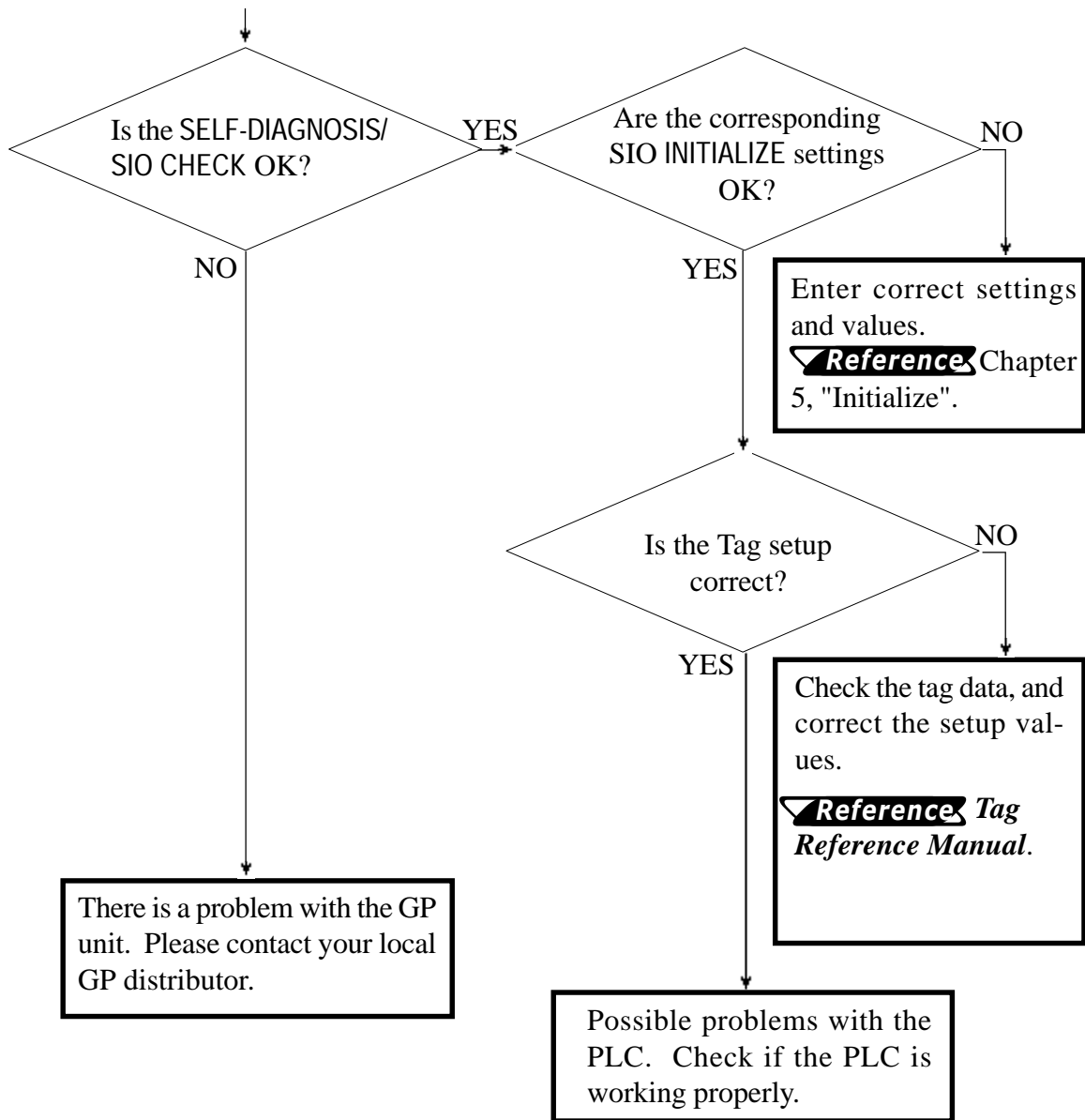

Note:

- To run SELF-DIAGNOSIS options RS-232C Check/ RS-422 Check, special tools become necessary.

Reference SELF-DIAGNOSIS section in this chapter

Chapter 6 - Run & Errors

4. Touch Panel Does Not Respond

When the touch panel does not respond, or its response time is very slow after it is pressed, please use the flowchart below to find the origin of the problem, and the appropriate solution.

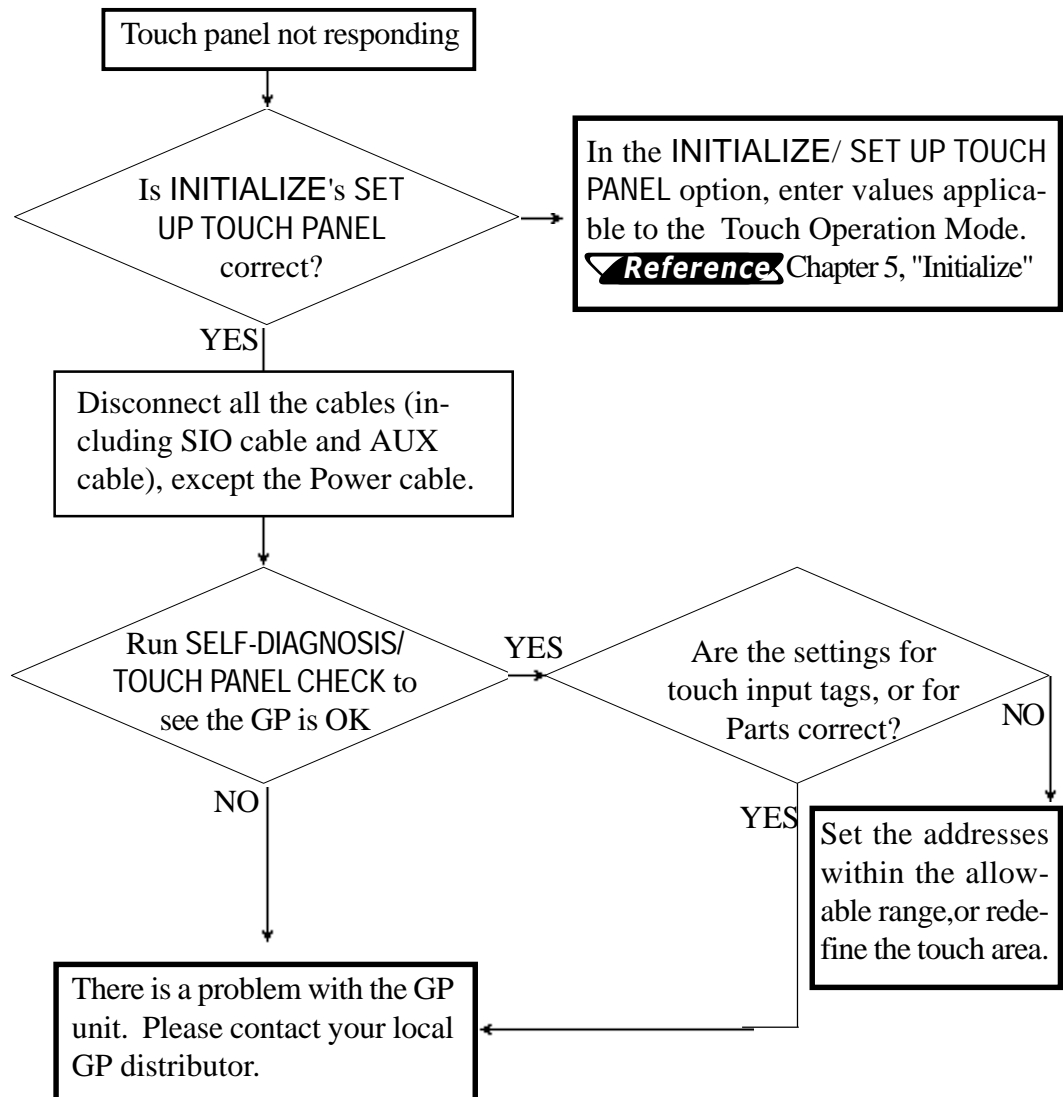

6.3 SELF-DIAGNOSIS

The GP unit is equipped to check its own System and Interface for any problems. Use it to help diagnose any problems.

1. GP SELF-DIAGNOSIS Menu

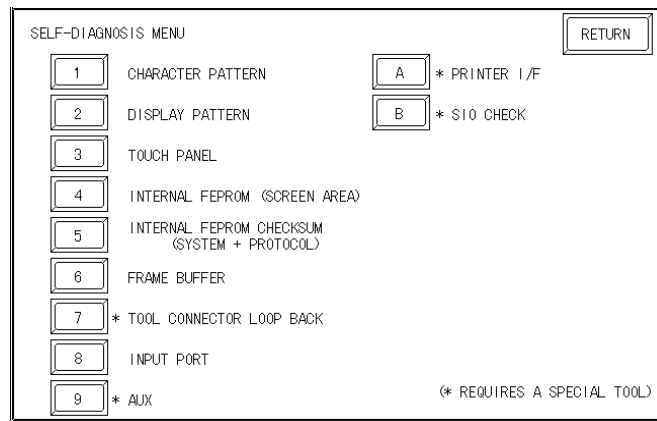

- 1 Checks the characters inside the internal Character ROM.
- 2 Checks all the figures and tiling patterns.
- 3 Checks each GP touch panel square.
- 4 Checks the internal hard disk contents (FEPRM).
- 5 Checks the System and Protocol of the GP Internal Memory (FEPRM).
- 6 Checks the internal display memory (Frame Buffer).
- 7 *Checks the Tool Connector control lines and send/receive lines.
- 8 Checks the Input Port. (for Digital's maintenance use only)
- 9 *Checks the AUX control line.
- A *Checks the printer interface.
- B *Checks the RS-232C and RS-422 send/receive lines.



The SELF-DIAGNOSIS menu items marked with an asterisk (*) require special tools. Please prepare the required tool/cable for each test.

2. SELF-DIAGNOSIS - Details

This section explains the contents of SELF-DIAGNOSIS. For information on how to operate the Screen, **Reference** Chapter 4, "OFFLINE Mode"; for information about how to set up the *Special Tools*, **Reference** Chapter 3, "Installation and Wiring".

CHARACTER PATTERN

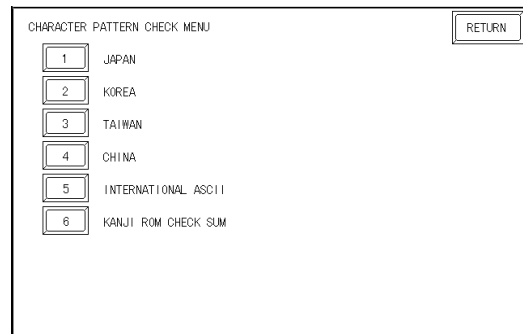

Use this check, which runs the character ROM CHECK-SUM CHECK, when characters do not display on the screen. Check each font pattern or the Kanji ROM using the sub-menu displayed above. If everything is normal, **OK** displays; if there is a problem, **NG** displays.

DISPLAY PATTERN

Checks the drawing function—when the buzzer will not sound and when the device contents will not display correctly—by running checks on the various screen pattern displays (8 screens) and on the On/Off Display. When the On/Off Display is checked, the Buzzer On/Off check is run simultaneously. If everything is normal, **OK** displays; if there is a problem, **NG** displays.

TOUCH PANEL

Touch Panel check. Checks if each touch cell highlights when pressed.

INTERNAL FEPROM (SCREEN AREA)



- **When this check is carried out, all the contents in the memory are erased. Please make sure that all data is backed up before running this check.**
- **After running the check, initialize the internal memory (FEPROM).**

This feature checks for any problems that may arise in the display. But to run the check, a password*1 is necessary.

When running the check, the screen will change as follows.

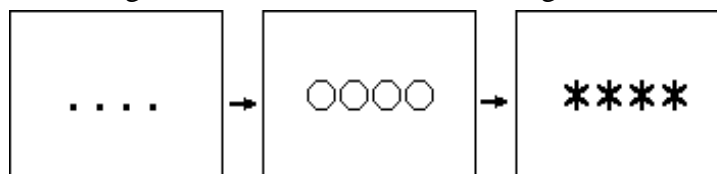

*1 Enter the password as setup in the INITIALIZE option, or the default password 1101.

When the FEPROM is normal, **OK** displays; if there is a problem, an error message appears.

INTERNAL FEPROM CHECKSUM (System & Protocol)

The Internal FEPROM System and Protocol check searches for any problems that may arise during operations. When running the check, the screen undergoes changes like those in the diagrams below.

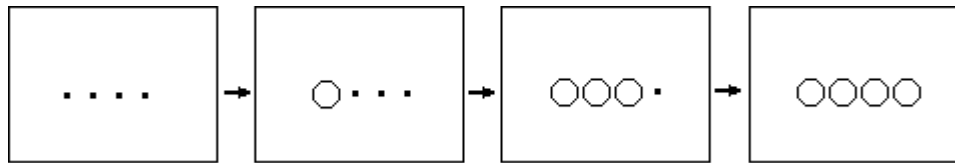

When the FEPROM is normal, **OK** displays; if there is a problem, an error message appears. This check does not erase the System or Protocol.

FRAME BUFFER

The Frame Buffer (display memory) Check looks for any display problems that may develop. When everything is normal, **OK** displays; when there is a problem, an error message displays.

TOOL CONNECTOR LOOP BACK

Use the Tool Connector Control line and Send/Receive line check when the GP cannot send and receive data from the PC. To run the check, connecting a *Tool Connector Check Loop Back Cable* (Dsub25 pin female connection) mounted to the *Downloading Cable* (provided in the software package) is necessary.

When everything is normal, **OK** displays; when there is a problem, an error message displays.

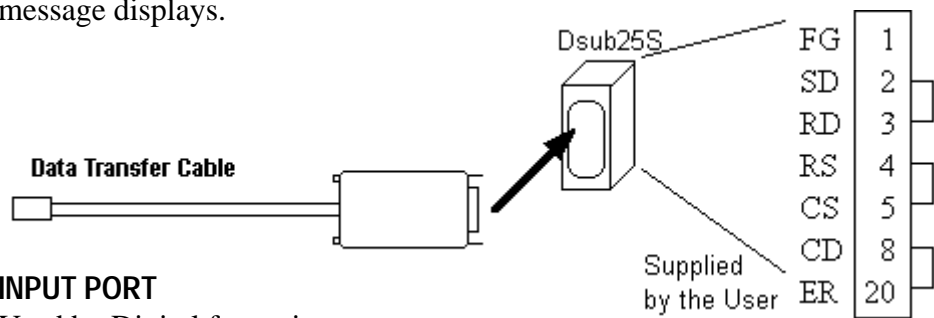

INPUT PORT

Used by Digital for maintenance purposes.

AUX

The AUX Control line check looks for problems in the Inching output and the Monitor output. To run the check, the PLC input must be connected.

Reference Chapter 2.3, "Interface Specifications"

Chapter 6 - Run & Errors

This check works by using the Input unit's LED lighting, following the steps below.

- ① Set AUX lines from TSW0 to BUZZ, ON.
- ② Once all of them turn ON, they will turn OFF in the same order.
- ③ Once all of them have turned OFF, the check is finished.

PRINTER I/F

PRINTER I/F checks to see if the printer operates normally. This check necessitates the connection of the printer.

When a Print Buffer is used, sometimes an error occurs, so **connect the printer directly to the GP.**

If normal, the printed section displays **20~7D<HEX>** and **A0~DF<HEX>** and **OK**; if there are problems, an error message appears.

SIO CHECK

Checks the RS-232C and RS-422 SIO lines for areas where correspondence problems develop. In the menu, select which check to run. To run the check, connecting the SIO cable is necessary. If all is normal, **OK** displays; if there is a problem, an error message appears.

The SIO cable wiring is as shown below. (RS-232C, RS-422 common)

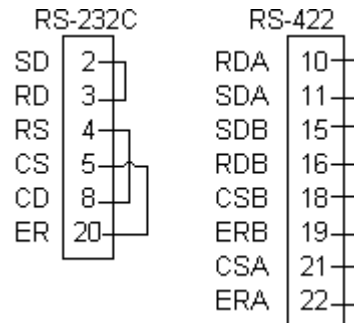

6.4	Error Messages
------------	-----------------------

This section explains the messages that appear when an error has occurred in the GP unit during RUN mode. The origin of the problem behind each error message is explained with appropriate ways of disposing of the error.

After a problem has been solved, unplug the GP's power cable and then reattach it.

1. Error Message List

The error messages listed below appear on the GP unit. Instructions on how to find and solve problems causing these error messages are explained on the following pages.

- SYSTEM ERROR
- ILLEGAL ADDRESS IN SCREEN DATA
- UNSUPPORTED TAG IN SCREEN DATA
- PLC NOT CONNECTED (02:FF) and (02:F7)
- PLC NOT RESPONDING (02:FE)
- RECEIVE DATA ERROR (02:FD)
- PLC COM. ERROR
- SCREEN MEMORY DATA IS CORRUPT
- CLOCK SETUP ERROR
- SCREEN TRANSFER ERROR
- SCREEN TAG LIMIT EXCEEDED
- OBJ. PLC HAS NOT BEEN SETUP
- GP STATION NO. DUPLICATION ERROR (02:F9)
- NETWORK ADDRESS ERROR (02:F8)



Note: If there is more than one error, the GP displays the error message for the last error detected.

2. Error Messages—Details

SYSTEM ERROR

Indicates a fault in the basic operations of the GP.

Following the error message, an error code, as shown, will appear. Report the error number, and details on how the error developed, to your local GP distributor.

- **SYSTEM ERROR (03 : x x)**

Displays when a PC transferred file cannot be rebuilt.

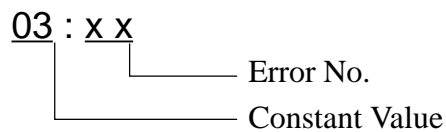

- **SYSTEM ERROR (x x x : x x x : x x x)**

Displays in RUN mode when a file cannot be rebuilt.

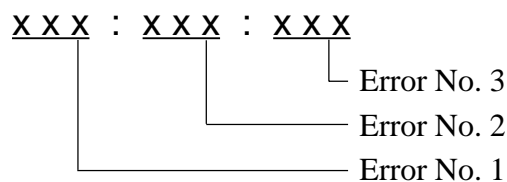

- **Offline mode displays while in RUN mode**

When the GP changes to OFFLINE mode without pressing the screen, there is a possibility that the screen data has been damaged. When the screen data is damaged, after the SYSTEM ERROR displays, the screen automatically reverts to OFFLINE mode after about 10 seconds. Run the INITIALIZE MEMORY command and transfer the GP screen data again from your PC.

ILLEGAL ADDRESS IN SCREEN DATA

Caused by an overlap of addresses.

Following the error message, error codes, as listed below, appear. If the error cannot be fixed, please report the error code and details on how the error developed to your local GP distributor.

ILLEGAL ADDRESS IN SCREEN DATA (0 0 B : x x x : x x x)

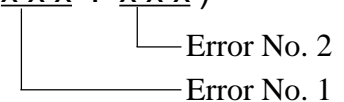

(See Table on next page)

Overlapping Addresses Table

Error 1	Error 2	Meaning
0C1	191	All or part of the T-File ^{*1} or S-tag address range overlap the addresses of System Data Area.
	192	
	193	
0C2	194	All or part of the System Data Area address, A-File, or S-tag address range overlap the addresses setup in a T-File ^{*1}
	195	
	196	
0C3	197	All or part of the T-File ^{*1} , or the S-tag or K-tag address range overlap the address range set in an A-file.
	198	
	199	
0C9	19B	All or part of the T-File ^{*1} , or the S-tag or K-tag address range overlap the address range set in an A-file.

Overlapping addresses, other than the ones mentioned above, can also cause the Illegal Address message.

E.g. When the starting address of the System Data Area is set to 100, and the tag below is setup:



Tag Name/ Part ID No.	Word Address	Tag Format
N1	99	BCD32

The N-tag is set to 32 bits, meaning it uses two word addresses. Since the first address is 99, the second address must be 100. Address 100 is ineligible for use since it has already been used for the System Data Area.

UNSUPPORTED TAG IN SCREEN DATA

A list of tag(s) in use that are unsupported by the current GP version appear with this error message. Setup the tags to correspond with the GP.

Reference Tag Reference Manual.

PLC NOT CONNECTED (02:FF) (02:F7)

Displays when communication with the PLC has stopped for over 60 seconds, when there is a transmission timeout error, or when there is excess noise. Check the correspondence cable wiring and connect correctly.

*1 For details about the T-File (trend graph) and A-File (alarm messages),

Reference Tag Reference Manual.

Chapter 6 - Run & Errors

PLC NOT RESPONDING (02:FE)

Displays when there is a Reply Timeout Error, or when there is excess noise.

The origin of the problem and the matching solutions are listed in the table below.

ORIGIN	SOLUTION
1. The power for the PLC host is not activated. 2. GP unit INITIALIZE setup (Setup I/O, PLC Setting) is incorrect. 3. The host and GP powering up process was incorrect. 4. The Communication Cable was not connected properly.	1. Turn On the host's power switch. 2. Setup the unit correctly and match up with the current host and Communication Cable. 3. Turn the host's power On first, wait 2-3 seconds, then power up the GP unit. 4. Check the Communication Cable wiring and connect it up properly.

RECEIVE DATA ERROR (02:FD)

This problem arises as a result of one of these three:

- There is a problem in trying to receive the data
- The connected PLC and the PLC setup for the data is different
- Noise

These errors, except for noise, appear when the Communication Cable is pulled out when the GP unit is On, or when normal communication operations are being run, but the GP has been powered Off, then back On. To solve the problem, simply begin running transmissions again.

When the error is a result of noise, correct any improper connections.

GP STATION NO. DUPLICATION ERROR (02:F9)

This error appears for one of two reasons:

- The GP number is same as the station number for another GP. Check all the GP station numbers.
- In the middle of correspondences, the PLC power has been turned On/Off. Reset the power on the PLC and GP.

NETWORK ADDRESS ERROR (02:F8)

The SIO address setup for the GP is different from other GP's. Check the address setup for all the GP's.

PLC COM. ERROR

Appears when the address setup for tags exceeds the address range on the host side. Check the Error Number that appears and use the following table to solve the problem.

PLC COM. ERROR (02 : x x)

└─ Error code (see the table below)
└─ Constant Value

Error #	Origin	Solution
FC	The communication settings for this unit and the host do not match.	Fix the SIO communication settings to match the host.
FB	The address set on a tag, the address used for storing data for Trend Graph, or the address set by an alarm message is out of a set range. (address range error) * Memory to Memory type. * Siemen's PLC Series	* When using GP-PRO2's Memory to Memory Type: Set the addresses within the set range of the System Data Area. (0~1023) * When using Siemen's Series PLC Type: Set up the Data Block in the PLC where the System Data area is set.
FA	Address range error	Set the addresses within the allowable range.
53	When using a Matsushita Electronics PLC, and there are too many screen tags, the PLC will not receive data.	Decrease the number of tags on the screen.
51	The tag address, Trend graph data storage address, Alarm message Registry address, and the like, do not exist in the PLC's internal memory. (In the case of Fuji Electric PLC)	Setup the addresses in a device range that exists.
Others	The Error Number for each PLC is displayed. Look up the Error Number in the indicated PLC manual. Or, report the Error Number to the PLC maker.	



- **Disregard the above table if Error Number 51 appears and you are using a PLC other than Fuji Electric. Look up the error contents in your PLC manual and follow the instructions therein.**
- **Disregard the above table if Error Number 53 appears and you are using a PLC other than Matsushita Electronics. Look up the error contents in your PLC manual and follow the instructions therein.**
- **In Hitachi's HIDIC H (HIZAC H) Series, the error code is divided into 2 bytes, whereas the GP Error Number is composed of 1 byte codes.**

E.g. Reply Return Display
 Command Code Error No.

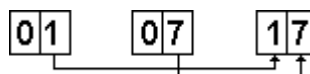



When the displayed error number is 8*, or 5*, use only the left column as the error number.

- In Toshiba's PROSEC T Series, the Error Code is 4 places long; on the GP, Error Numbers are displayed and changed into Hexadecimal.

E.g.

0	1	3	4
---	---	---	---

 →

8	6
---	---

- With the Allen-Bradley PLC-5 and SLC-500 Series, the EXT/STS error codes have been re-mapped to start at D0 HEX, so they will not conflict with other error codes. When looking up the error number in the PLC manual, subtract D0 h from the GP error code to find its error value.

E.g.

GP Error Code	→	PLC Error Code
D1	→	01
EA	→	1A

SCREEN MEMORY DATA IS CORRUPT

Displays when the *checksum* of the screen memory data does not match because of a corruption in the screen files.

Error codes, as shown below, follow the error message. By referring to the error code, check the screens that have errors. When a screen file has been corrupted, delete that file, and make a new one (or recall a backup copy if available).

SCREEN MEMORY DATA IS CORRUPT (X X X X : X X X X)

The Screen Number that has an error. The number of screens that
 (Displays only one per Screen Number.) have errors (Decimal)

CLOCK SET UP ERROR

This message displays when the backup battery for the internal clock is dead. If the battery is incorrectly replaced, the battery may explode. To avoid the danger, please do not replace the battery yourself. When the battery needs a replacement, please consult with your local GP distributor.

After changing the backup battery, set up the internal clock.

Reference Chapter 5, "Initialize".



The life span of the backup battery depends on the battery's ambient temperature and the amount of current being charged and used. The table below gives a general indication of how long the battery will last.

Battery Ambient Temperature	under 40°C	between 40 to 50°C	between 40 to 50°C
Expected Life Span	over 10 yrs.	over 4.1 yrs.	over 1.5 yrs

SCREEN TRANSFER ERROR

Displays when an error occurs in the data transmission from the screen editor to the GP panel. Try re-transmitting the screen data.

SCREEN TAG LIMIT EXCEEDED (max 256)

When tags are setup beyond the tag limit, these tags are made invalid. Tags are invalidated from the end tag, in the opposite order in which they were registered. Plus, when tags involve registered Windows and loaded screens, they are invalidated in this order: Window Registry, Load Screen. Further details for when multiple displays are set to one screen:

1. Invalidate registered windows from the end screen.
2. Invalidate loaded screens from the end screen.

Check invalidated tags and reduce the tag number.

OBJ. PLC HAS NOT BEEN SETUP (02:F9)

The host PLC setup in SOFTWARE's does not match the PLC in use. Use the Error Code that follows the error message to select the proper PLC type in the GP and correct the INITIALIZE setup.

OBJ. PLC HAS NOT BEEN SETUP (x x)

↓
The PLC number (*Hexadecimal*)
written to the System File
(*See next page's Table*)

Chapter 6 - Run & Errors

PLC #	PLC TYPE	PLC #	PLC TYPE
0	SYSMAC - C	20	SIEMENS S5 135-115
1	MELSEC - AnN (Link)	21	SIEMENS S5 3964(R) protocol
2	NEW SATELLITE JW	22	Allen Bradley PLC-5
3	FA500 (for GP-PRO/PB3: FACTORY ACE)	28	Allen Bradley SLC500
4	MICREX-F	63	FA500M 1:n SIO (for GP-PRO/PB3: FACTORY ACE 1:n)
6	TOYOPUC-PC2	66	GE FANUC 90SNP
7	MEWNET-FP	67	HIZAC EC
8	HIDIC-S10	68	IDEC 1
9	Memocon-SC	69	IDEC 2
B	MELSEC-AnA (LINK)	6A	IDEC3
D	SYSMAC-CV	6B	FANUC Power Mate
E	PROSEC EX2000	6C	MICRO3
10	HIZAC H	81	MELSEC-AnN (CPU)
11	MELSEC-FX	8B	MELSEC-AnA (CPU)
12	MELSEC-F2	0C	KOSTAC SR21/22
14	KOSTAC SG8	6D	KEYENCE
15	PROSEC T	1C	MELSEC - QnA(Link)
4D	MEMORY LINK (SIO Type)	1D	MELSEC-QnA (CPU)
18	FLEX-PC	6F	FLEX-PC(CPU)
1B	TC200	6E	SELMART
1F	SIEMENS S5 90-115		

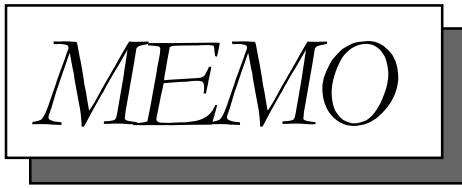

Chapter 7

Maintenance

1. Regular Cleaning
2. Periodic Checkup
3. Changing the Backlight

7.1 Regular Cleaning

7.1.1 Cleaning the Display

When the surface or the frame of the display gets dirty, soak a soft cloth in water with a neutral detergent, wring the cloth tightly, and wipe the display.



- Do not use paint thinner, organic solvents, or a strong acid compound to clean the unit.
- Do not use hard or pointed objects to operate the touch-screen panel, since it can damage the panel surface.

7.1.2 Installation Gasket Check/Replacement

The installation gasket protects the GP and improves its water resistance. For instructions on installing the GP's gasket, refer to

Reference Chapter 3 "Installation and Wiring"



A gasket which has been used for a long period of time may have scratches or dirt on it, and could have lost much of its water resistance. Be sure to change the gasket periodically (or when scratches or dirt become visible).

■ Attaching the Installation Gasket

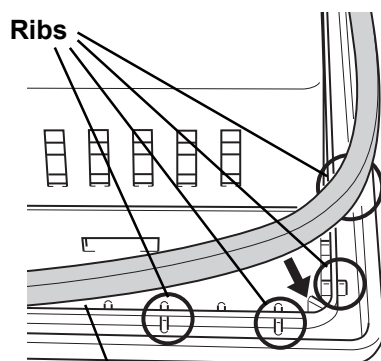

- 1) Each of the GP's corners has 4 ribs that hold the installation gasket in place. Push the gasket into the side of the GP, so that it is held by all 4 ribs.



- **The gasket is flexible, but not elastic, and may tear if stretched too far. Do not stretch the gasket around the ribs, only push.**
- **Be sure the gasket's seam is not inserted into any of the unit's corners, only in the straight sections of the groove. Inserting it into a corner may lead to its eventually tearing.**

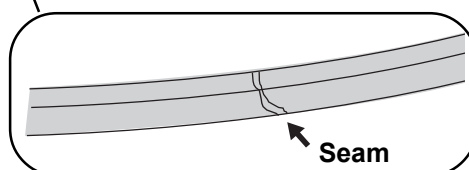

Case Cross Section

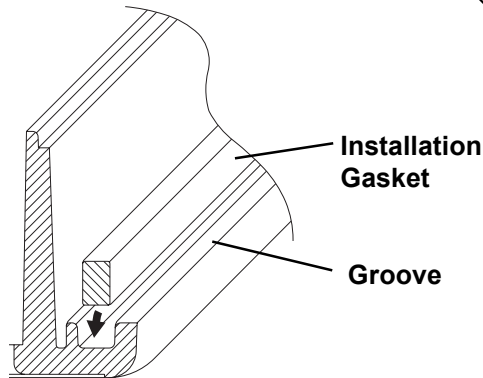

Be sure to insert the gasket into the groove so that the long side is vertical.

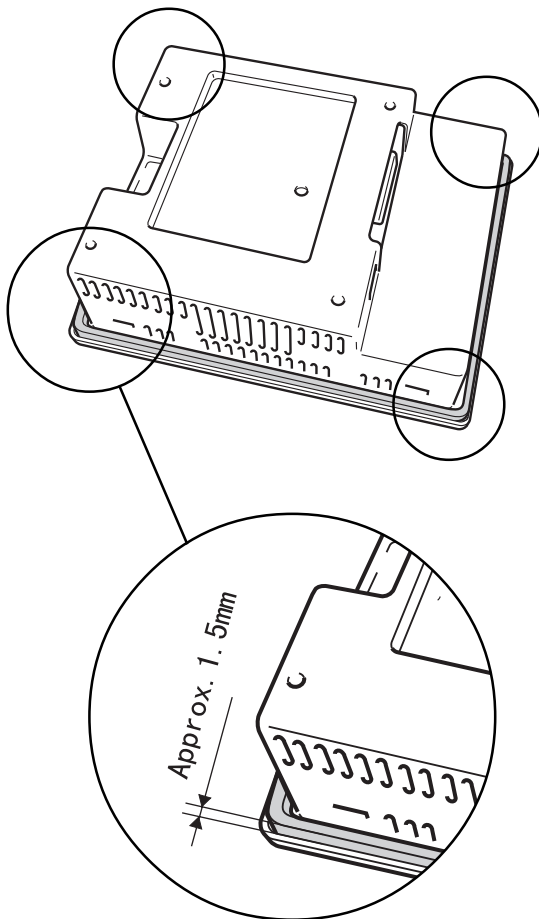

2) Insert the gasket into the GP's three remaining corners, as shown in step 1.



- **The gasket must be inserted correctly into the groove for the GP's moisture resistance to be equivalent to IP65f.**
- **The upper surface of the gasket should extend approximately 1.5mm out from the groove. Be sure to check that the gasket is correctly inserted before installing the GP into a panel.**

7.2 Periodic Check-Up

To keep your GP unit in its best condition, please inspect the following points periodically.

GP Operation Environment

- Is the temperature within the allowable range?
(0~50 degrees Celsius for GP-470; 0~40 degrees Celsius for GP-570)
- Is the humidity within the specified range?
(20~85% RH for GP-470; 30~85% RH for GP-570)
- Is the GP's operating atmosphere free of corrosive gas?

Electrical Specifications

- Is the input voltage appropriate?
Units using AC 85 to 132V:
GP470-EG11, GP570-TC11, GP571-TC11, GP570-SC11
Units using DC24V \pm 20% (DC 19.2 to 28.8):
GP470-EG21, GP470-EG31, GP570-TC21, GP570-TC31, GP570-SC21, GP570-SC31

Peripheral Items

- Are all cables connected properly? Are they loose?
- Are all mounting brackets holding the unit securely?
- Are there many scratches or traces of dirt on the moisture resistant gasket?

7.3 Changing the Backlight

Replacing the backlight is only possible with GP-570 Series units. The backlight replacement method varies, depending on if the unit is a GP570-TC21-** Rev. E, or any one of the following:

- GP570-TC21** Rev. A to D GP570-TC**
- GP571-TC** GP570-SC**



Warning

- Whenever changing the backlight, be sure the GP's power cord has been disconnected and that the unit is cooled down.
- When the GP's power cord is connected and the GP is ON, high voltage runs through the *wires in the backlight area—do not touch them!*
- When the GP's power has just been turned OFF, the backlight area is still very hot! Be sure to wear gloves to prevent being burned.

 **Important** • *Be sure the backlight model number is correct for the GP unit.*

Unit Name	Backlight Model Number
GP570-TC**	GP570-BL00-MS
GP570-SC**	
GP571-TC**	

 **Important** • *With GP570-TC21** units that are Rev. E, when changing the backlight, be sure to use backlight model GP577RT-BL00-MS.*

• *The Rev. (revision) seal can be found on the back of the unit (see below). The “*” mark indicates the unit’s revision code.*



■ **<GP570-TC21**Rev. A to D/ GP570-TC11**/GP571-TC**/GP570-SC** Units>**

Please follow the steps given below. Be sure to wear gloves when performing this work.

- 1) Turn the GP’s power OFF (i.e. disconnect the GP’s power cord).
- 2) Use a phillips screwdriver to remove the case’s two rear attachment screws.

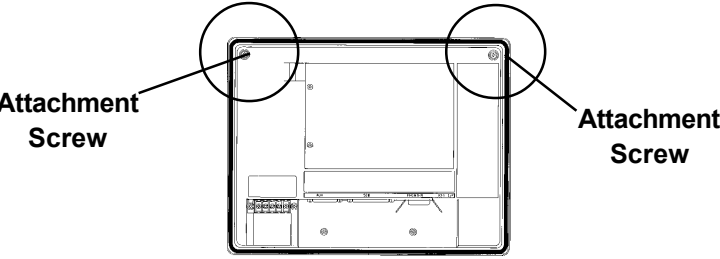

Chapter 7 - Maintenance

- 3) Open only the upper half of the GP's rear cover, and remove the connector.

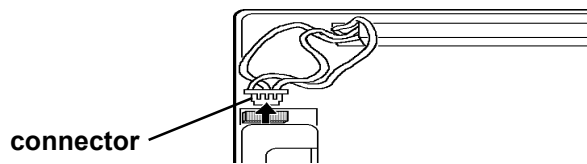

- 4) Remove the old backlight.

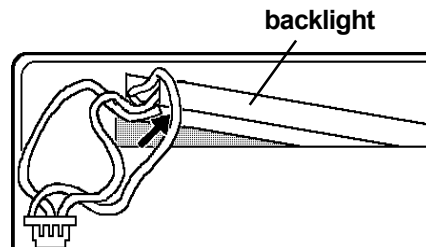

- 5) Insert a new backlight, and reattach the backlight's connector.
6) To replace the GP's rear cover, insert the cover's guide tabs into the case's tab slots, and close the cover.

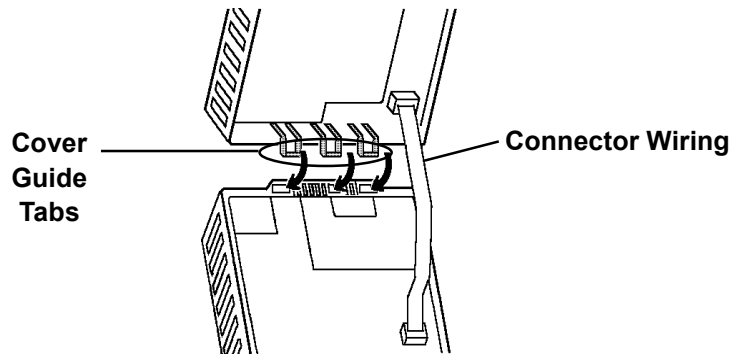

- 7) Next, reattach the cover's two attachment screws.



Be careful that the connector's wiring does not become caught or pinched between the front and the rear covers.

■ <GP570-TC21-** Rev. E Unit

Please follow the steps given below. Be sure to wear gloves when performing this work.

- 1) Turn the GP's power OFF (unplug the GP's power cord).
- 2) Use a Phillips screwdriver to remove the case's two rear attachment screws.

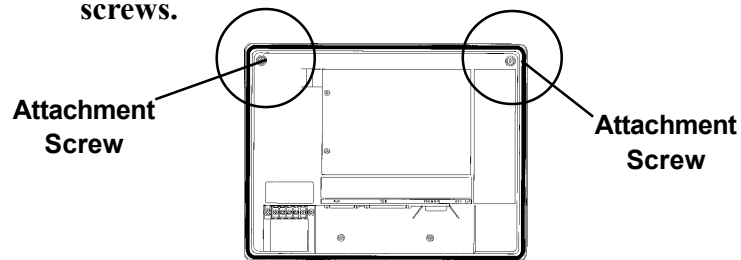

- 3) Unscrew the upper backlight holder's two attachment screws and remove the metal backlight cover.

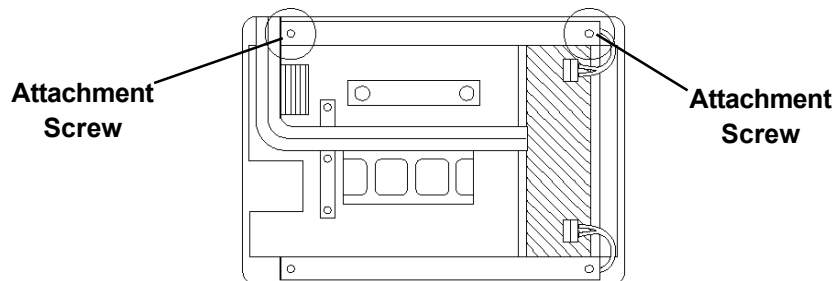

- 4) Unplug the upper lamp's power connector.

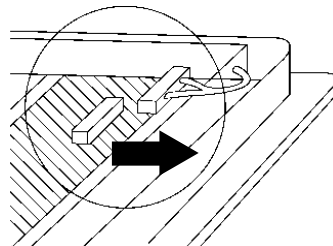

- 5) Remove the old backlight and replace it with a new one.
Be sure to reattach the upper lamp's connector and attachment screws.

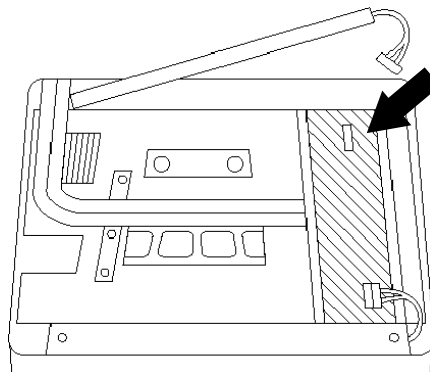

Chapter 7 - Maintenance

6) Remove the lower backlight holder's 2 attachment screws.

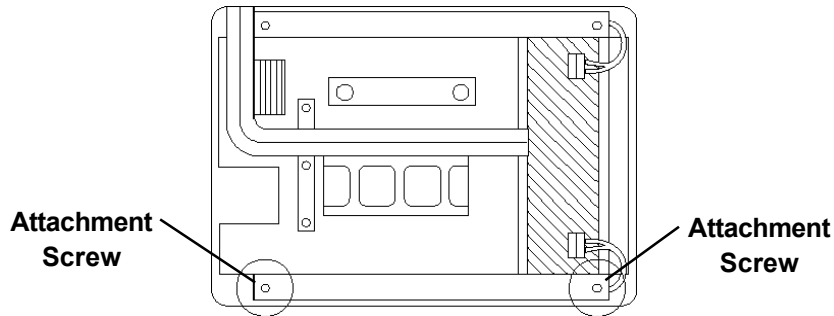

7) Remove the lower lamp's power connector.

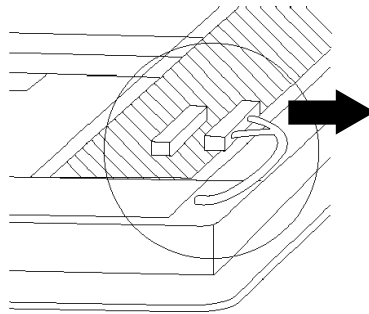

8) Insert the metal backlight cover's three positioning tabs into the backlight's three positioning slots. Next, retighten the cover's two attachment screws.

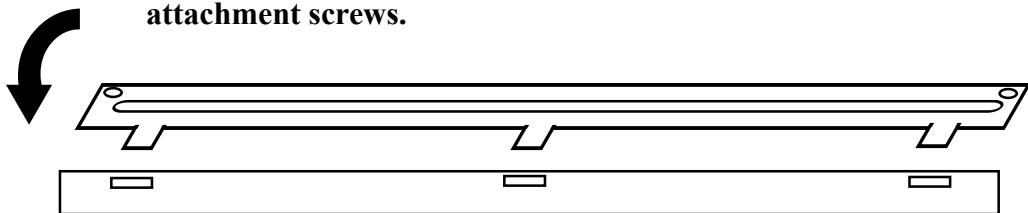

9) Remove the old backlight and replace it with a new one. Be sure to reattach the power connector and the rear cover's 2 attachment screws.

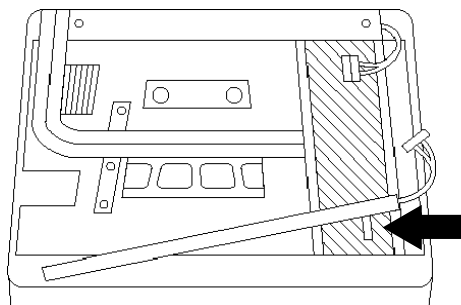

Be sure not to pinch or cut any of the GP's internal wiring when closing the case.



Index

Symbols

1:1 5-1

A

Alarm Display 5-3

AUX Interface 1-2, 2-6

B

Bar Code Reader 1-3

C

Cable

DC24V Parallel I/F 1-4

Downloading Cable 1-3

Mitsubishi PLC Procon I/F 1-3

RS-232C 1-3

RS-422 1-3

Change Screen 5-4

Circuit

Input 2-8

Output 2-8

Circuit Load 2-8

COMMUNICATION SETUP

RECEIVETIMEOUT 5-13

RETRYCOUNT 5-13

Connection Part 5-16

Cover Sheet 1-4

CUSTOMIZE SETUP

GP TOUCH MONOPOLIZE 5-19

MONOPOLIZE TIME 5-19

PLCPRIORITY 5-18

E

Error Messages

CLOCK SETUP ERROR 6-19

GP STATION NO. REPEATED 6-17

ILLEGAL ADDRESS IN SCREEN DATA 6-15

INCORRECT STORAGE INFORMATION ADDRESS
6-17

OBJ. PLC HAS NOT BEEN SETUP 6-20

PLCCOM. ERROR 6-18

PLC NOT CONNECTED 6-16

PLC NOT RESPONDING 6-17

RECEIVEDATA ERROR 6-17

SCREEN MEMORY DATA IS CORRUPT 6-19

SCREEN TRANSFER ERROR 6-20

SYSTEM ERROR 6-15

UNSUPPORTED TAG IN SCREEN DATA 6-16

F

FORCERESET 5-11-5-12

Force Reset 4-2

G

Global Window 5-5

GLOBAL WINDOW SETUP

DATA FORMAT 5-6

GLOBAL WINDOW 5-5

GLOBAL WINDOW ACCESS 5-5

REGISTRATION NO. (1-256) 5-6

WINDOW LOCATION 5-6

GP-570 Backlight Bulb 1-4

GP-70 Series Installation Brackets 1-4

Graphic Panel

Auxiliary Input/Output 2-10

Caution v

Clock 2-4

Display 2-10

Display Functions 2-3

GP-470 Series External Dimensions 2-11

GP-570 Series External Dimensions 2-12

Installation Fasteners 2-13

Installation Dimensions 2-14

Interface 2-6

Names and Functions of parts 2-10

Package Contents ix

Power Input Terminal Block 2-10

Printer Interface 2-10

Screen Memory 2-4

Serial Interface 2-10

Tool Connector 2-10

Touch Panel 2-10

Ventilation 3-2

I

INITIALIZE 4-3, 4-4-4-5, 5-1

INITIALIZE MEMORY	5-20
Installation	3-1
Installation Brackets	1-4

L

Load Current	2-8
Load Voltage	2-8
Local Window	5-5

M

Main Menu	4-3
Memory Loader	1-3
Mitsubishi PLC A-Series	
2 Port Adapter	1-3
Program Port I/F Cable	1-3
Mitsubishi PLC A-Series	
Program Port I/F Cable	1-3
Mitsubishi PLC FX-Series	
Program Port I/F Cable	1-3

N

n:1	5-1
NETWORK INFORMATION ADDRESS	5-16
Notes on UL Application	vii

O

Off-line Mode	4-1, 6-1
---------------------	----------

P

PLCPRIORITY	
Display Priority and Operation Priority Speed Diff .	
.....	5-18
PLC SETUP	5-14
CUSTOMIZE SETUP	5-18
SET UP OPERATION SURROUNDINGS (n:1)	
.....	5-15
SET UP OPERATION SURROUNDINGS (1:1)	
.....	5-14
STATION SETUP	5-16
Power Terminal Block	3-6
Power-up Sequence	5-3
Printer	1-3
Printer Connection	3-9
Printer Interface	1-2, 2-6
Program Port	1-2

R

RS-232	2-9
RS-232C Port	1-2
RS-422	2-9
RS-422 Connector Terminal Exchange Adapter	1-3
RS-422 Port	1-2
Rubber Gasket	1-4, 7-1
RUN	4-3

S

SCREEN DATA TRANSFER	4-3
Screen Saver Function	5-3
SELF-DIAGNOSIS	4-3, 4-6-4-7, 6-10
AUX	6-13
CHARACTER PATTERN	6-11
COMMUNICATION CHECK	6-13
DISPLAY PATTERN	6-11
FRAME BUFFER	6-12
INPUT PORT	6-13
INTERNAL FEPROM	6-11
INTERNAL FEPROM CHECKSUM	6-12
KEYBOARD LOOPBACK	6-12
PRINTER I/F	6-13
TOUCH PANEL	6-11
Serial Interface	1-2, 2-8
SET UP I/O	5-9
COMMUNICATION SETUP	5-13
SET UP PRINTER	5-10
SET UP SIO	5-9
SET UP TOUCH PANEL	5-11
SET UP OPERATION SURROUNDINGS	
STARTING ADDRESS OF SYSTEM DATA AREA	
.....	5-14, 5-15
SYSTEM AREA--READING AREA SIZE	
.....	5-14, 5-15
UNIT NO.	5-14, 5-15
SET UP PRINTER	
BLACK/WHITEREVERSE	5-10
PRINT	5-10
PRINTER TYPE	5-10
SET UP SCREEN	5-21
ALARM MESSAGE	5-21
FONT SETTING	5-21
INITIAL SCREEN NO.	5-21
KANJI FONT QUALITY	5-21
ON-LINE ERROR DISPLAY	5-21
SET UP SIO	5-9
COMMUNICATION FORMAT	5-10

Index

CONTROL	5-9
DATA LENGTH	5-9
PARITY	5-9
STOP BIT	5-9
SET UP TIME	5-20
SET UP TOUCH PANEL	
BRIGHTNESS ADJUSTMENT	5-12
CONTRAST ADJUSTMENT	5-12
FORCERESET	5-11
TOUCH OPERATION MODE	5-11
Specifications	
Electrical	2-1
Environmental	2-2
Interface	2-6
Structural	2-2
STATION SETUP	
NETWORK INFORMATION ADDRESS	5-16
STATION NO.	5-17
Surge Absorber	3-8
Symbols	x
SYSTEM AREA SETUP	
System Area Size	5-4
SYSTEM ENVIRONMENT SETUP	5-3
CHARACTER STRING DATA MODE	5-6
GLOBAL WINDOW SETUP	5-5
SYSTEM AREA SETUP	5-4
SYSTEM SETUP	5-3
SYSTEM SETUP	
BUZZER TERMINAL OUTPUT	5-3
DATA TYPE OF SCREEN NO.	5-4
PASSWORD (0-9999)	5-3
STAND-BY MODE TIME (0-255)	5-3
START TIME (0-255)	5-3
TOUCHBUZZER SOUND	5-3
System Structure	1-2

T

Termination Resistor	6-7
Tool Connector	1-2, 3-10
Touch Screen	5-3
Transfer Screen Data	4-8-4-9
Troubleshooting	6-2-6-3
No Display	6-4
The Touch Panel Does Not Work	6-9
Would Not Communicate	6-7

V

Verification Part	5-17
Voltage Load	2-8

Voltage Transformer	3-6
---------------------------	-----

W

Wiring	3-5
Grounding	3-8
Input/Output Signal Lines	3-9
Power Cable	3-5
Power Supply	3-7

