

**Digital**  
*Human Machine Interface* ———

**Pro-face**

# GP-2300/2301 Series User Manual

**Digital**  
Digital Electronics Corporation

# Preface

---

Thank you for purchasing the Pro-face GP-2300/2301 Series programmable operator interface (hereafter referred to as the "GP unit").

This GP unit, with its expanded functionality and improved overall performance, is an upgrade of Pro-face's previous GP series panels. GP-2300/2301 Series units allow you to use the Ethernet (GP-2300 Series only) and CF Card features without attaching separately sold expansion units.

Please read this manual carefully as it explains, step by step, how to use the GP correctly and safely.

Also, in this manual's examples, the Mitsubishi MELSEC-AnA Series PLC is referred, whenever possible, as a point-to-point connection.

<Note>

- 1) It is forbidden to copy the contents of this manual, in whole or in part, except for the user's personal use, without the express permission of Digital Electronics Corporation of Japan.
- 2) The information provided in this manual is subject to change without notice.
- 3) This manual has been written with care and attention to detail; however, should you find any errors or omissions, please contact Digital Electronics Corporation and inform them of your findings.
- 4) Please be aware that Digital Electronics Corporation shall not be held liable by the user for any damages, losses, or third party claims arising from any uses of this product.

All Company/Manufacturer names used in this manual are the registered trademarks of those companies.

© 2003 Digital Electronics Corporation

# Table of Contents

---

<b>Preface</b> .....	<b>1</b>
<b>Table of Contents</b> .....	<b>2</b>
<b>Essential Safety Precautions</b> .....	<b>6</b>
<b>General Safety Precautions</b> .....	<b>10</b>
<b>GP-2300/2301 Series Model Names</b> .....	<b>12</b>
<b>Package Contents</b> .....	<b>12</b>
<b>UL/c-UL (CSA) Application Notes</b> .....	<b>13</b>
<b>CE Marking Notes</b> .....	<b>14</b>
<b>Revision Information</b> .....	<b>14</b>
<b>Documentation Conventions</b> .....	<b>14</b>

## **CHAPTER 1 INTRODUCTION**

<b>1.1 Prior to Operating the GP</b> .....	<b>1-1</b>
<b>1.2 System Design</b> .....	<b>1-2</b>
1.2.1 GP-2300 Series System Design .....	1-2
1.2.2 GP-2301 Series System Design .....	1-4
<b>1.3 Accessories</b> .....	<b>1-8</b>

## **CHAPTER 2 SPECIFICATIONS**

<b>2.1 General Specifications</b> .....	<b>2-1</b>
2.1.1 Electrical .....	2-1
2.1.2 Environmental .....	2-2
2.1.3 Structural .....	2-2
<b>2.2 Functional Specifications</b> .....	<b>2-3</b>
2.2.1 Display .....	2-3
2.2.2 Memory .....	2-4
2.2.3 Touch Panel • Clock .....	2-4
2.2.4 Interfaces .....	2-5
<b>2.3 Interface Specifications</b> .....	<b>2-6</b>
2.3.1 Serial Interfaces .....	2-6
2.3.2 Expansion Serial Interface .....	2-7
2.3.3 Printer Interface .....	2-8
<b>2.4 Part Names and Functions</b> .....	<b>2-9</b>

<b>2.5</b>	<b>Dimensions .....</b>	<b>2-12</b>
2.5.1	GP-2300/2301 Series External Dimensions .....	2-12
2.5.2	Panel Cut Dimensions .....	2-13
2.5.3	Installation Fasteners .....	2-14

## **CHAPTER 3 INSTALLATION AND WIRING**

<b>3.1</b>	<b>Installation .....</b>	<b>3-1</b>
3.1.1	Installation Procedures .....	3-1
<b>3.2</b>	<b>Wiring Precautions .....</b>	<b>3-6</b>
3.2.1	Connecting the Power Cord .....	3-6
3.2.2	Connecting the Power Supply .....	3-8
3.2.3	Grounding .....	3-9
3.2.4	I/O Signal Line Placement .....	3-9
<b>3.3</b>	<b>Tool Connector .....</b>	<b>3-10</b>
<b>3.4</b>	<b>Ethernet Cable Connector .....</b>	<b>3-10</b>
<b>3.5</b>	<b>CF Card Insertion and Removal .....</b>	<b>3-11</b>
3.5.1	CF Card Handling .....	3-13

## **CHAPTER 4 DATA TRANSFER**

<b>4.1</b>	<b>Serial Data Transfer .....</b>	<b>4-1</b>
<b>4.2</b>	<b>Ethernet Data Transfer .....</b>	<b>4-4</b>
4.2.1	Checking the IP Address .....	4-6
<b>4.3</b>	<b>CF Memory Loader Tool .....</b>	<b>4-7</b>
4.3.1	Data Upload and Download .....	4-8

## **CHAPTER 5 OFFLINE MODE**

<b>5.1</b>	<b>Entering OFFLINE Mode .....</b>	<b>5-1</b>
5.1.1	After Plugging in the Power Cord .....	5-1
5.1.2	From the Menu Bar .....	5-2
<b>5.2</b>	<b>OFFLINE Mode Main Menu .....</b>	<b>5-3</b>
<b>5.3</b>	<b>Initialization .....</b>	<b>5-4</b>
<b>5.4</b>	<b>Self-Diagnosis .....</b>	<b>5-6</b>

**CHAPTER 6 INITIALIZING THE GP**

- 6.1 Initialization Screen ..... 6-1**
- 6.2 Initialization Items ..... 6-2**
- 6.3 System Environment Setup ..... 6-3**
  - 6.3.1 System Setup ..... 6-3
  - 6.3.2 System Area Setup ..... 6-4
  - 6.3.3 Global Window Setup ..... 6-6
  - 6.3.4 Character String Data Setup ..... 6-7
- 6.4 Set Up I/O ..... 6-10**
  - 6.4.1 Set Up SIO ..... 6-10
  - 6.4.2 Communication Setup ..... 6-12
  - 6.4.3 Set Up Touch Panel ..... 6-13
  - 6.4.4 Display Setup ..... 6-16
  - 6.4.5 Set Up Printer ..... 6-17
  - 6.4.6 Expansion Serial Setup ..... 6-19
  - 6.4.7 Expansion Serial Environment Setup ..... 6-20
  - 6.4.8 Set Up Capture Operation ..... 6-21
  - 6.4.9 FUNCTION SETUP ..... 6-22
  - 6.4.10 COMMUNICATION PORT SETUP ..... 6-22
- 6.5 PLC Setup ..... 6-23**
  - 6.5.1 Set Up Operation Surroundings (1:1/n:1) ..... 6-23
  - 6.5.2 Station Setup (n:1) ..... 6-24
  - 6.5.3 Customize Setup (n:1) ..... 6-26
  - 6.5.4 Ethernet Setup ..... 6-28
  - 6.5.5 SYSLOG Setup ..... 6-29
  - 6.5.6 Others Setup ..... 6-30
  - 6.5.7 Self-Diagnosis ..... 6-30
- 6.6 Initialize Internal Memory ..... 6-31**
  - 6.6.1 Initialize GP Memory ..... 6-31
  - 6.6.2 Initialize CF Card ..... 6-31
  - 6.6.3 CSV DATA INDEX ..... 6-32
- 6.7 Set Up Time ..... 6-33**
- 6.8 Set Up Screen ..... 6-34**
- 6.9 Font Setting ..... 6-35**

## CHAPTER 7 RUN MODE AND ERRORS

<b>7.1</b>	<b>RUN Mode</b> .....	<b>7-1</b>
7.1.1	After Connecting the Power Cord .....	7-1
7.1.2	Via OFFLINE Mode .....	7-2
<b>7.2</b>	<b>Self-Diagnosis</b> .....	<b>7-3</b>
7.2.1	Self-Diagnosis Item List .....	7-3
7.2.2	Self-Diagnosis - Details .....	7-4
<b>7.3</b>	<b>Troubleshooting</b> .....	<b>7-7</b>
7.3.1	Possible Types of Trouble .....	7-7
7.3.2	No Display .....	7-8
7.3.3	No GP/Host Communication .....	7-11
7.3.4	Touch Panel Does Not Respond .....	7-13
7.3.5	Buzzer Sounds when GP power is turned ON .....	7-14
7.3.6	Clock Settings Cannot be Entered .....	7-15
7.3.7	Error Screens .....	7-15
<b>7.4</b>	<b>Error Messages</b> .....	<b>7-16</b>
7.4.1	Error Message List .....	7-16
<b>7.5</b>	<b>Error Message Details</b> .....	<b>7-18</b>
7.5.1	System Errors .....	7-18
7.5.2	Illegal Address in Screen Data .....	7-20
7.5.3	PLC Com. Error .....	7-21
7.5.4	Clock Setup Error .....	7-22
7.5.5	Screen Tag Limit Exceeded (max. of 384).....	7-22
7.5.6	OBJ. PLC Has Not Been Setup .....	7-22
7.5.7	D-Script and Global D-Script Errors .....	7-23
7.5.8	Extended SIO Script Error .....	7-24

## CHAPTER 8 MAINTENANCE

<b>8.1</b>	<b>Regular Cleaning</b> .....	<b>8-1</b>
8.1.1	Cleaning the Display .....	8-1
8.1.2	Installation Gasket Check/Replacement .....	8-1
<b>8.2</b>	<b>Periodic Check Points</b> .....	<b>8-3</b>
<b>8.3</b>	<b>Replacing the Backlight</b> .....	<b>8-4</b>

## INDEX

# Essential Safety Precautions

This manual includes procedures that must be followed to operate the GP correctly and safely. Be sure to read this manual and any related materials thoroughly to understand the correct operation and functions of this unit.

## Safety Icons

Throughout this manual the following icons are provided next to GP operation procedures requiring special attention, and provide essential safety information. These icons indicate the following levels of danger:



Indicates situations where severe bodily injury, death or major equipment damage can occur.



Indicates situations where slight bodily injury or machine damage can occur.

## WARNINGS

### System Design

- Do not create GP touch panel switches that could possibly endanger the safety of equipment and personnel. Damage to the GP, its I/O unit(s), cable(s), and other related equipment can cause an output signal to remain continuously ON or OFF and possibly cause a major accident. Therefore, design all monitoring circuits using limit switches, etc. to detect incorrect device movement. To prevent accidents related to incorrect signal output or operation, design all switches used to control vital machine operations so they are operated via a separate control system.
- Please design your system so that equipment will not malfunction due to a communication fault between the GP and its host controller. This is to prevent any possibility of bodily injury or material damage.
- Do not use the GP unit as a warning device for critical alarms that can cause serious operator injury, machine damage or production stoppage. Critical alarm indicators and their control/activator units must be designed using stand-alone hardware and/or mechanical interlocks.
- The GP is not appropriate for use with aircraft control devices, aerospace equipment, central trunk data transmission (communication) devices, nuclear power control devices, or medical life support equipment, due to these devices' inherent requirements of extremely high levels of safety and reliability.

 **WARNINGS**

- Do not create switches used to control machine safety operations, such as an emergency stop switch, or a GP touch screen icon. Be sure to install these switches as separate hardware switches, otherwise severe bodily injury or equipment damage can occur.
- When using the GP with : transportation vehicles (trains, cars and ships), disaster and crime prevention devices, various types of safety equipment, non-life support related medical devices, etc., redundant and/or failsafe system designs should be used to ensure the proper degree of reliability and safety.

**Touch Panel**

- After the GP's backlight burns out, unlike the GP's "Standby Mode", the touch panel is still active. If the operator fails to notice that the backlight is burned out and touches the panel, a potentially dangerous machine operation error can occur.

If your GP's backlight suddenly turns OFF, use the following steps to determine if the backlight is actually burned out.

- 1) If your GP is not set to "Standby Mode" and the screen has gone blank, your backlight is burned out.
- 2) Or, if your GP is set to Standby Mode, but touching the screen does not cause the display to reappear, your backlight is burned out.

Also, use the GP's built-in "USE TOUCH PANEL AFTER BACKLIGHT BURNOUT" feature to prevent an accidental machine operation error. This feature can automatically detect a burnout and disable the touch screen.

**Wiring**

- To prevent electrical shock or equipment damage, unplug the GP unit's power cord from the power supply prior to installing or wiring the GP.
- Be sure to replace the GP's plastic terminal block cover after wiring is completed, since operating the GP without the cover may lead to an electric shock
- Do not use power beyond the GP's specified voltage range. Doing so may cause a fire or an electric shock.





## WARNINGS

### Battery Replacement

- The GP uses a lithium battery for backing up its internal clock data. If the battery is incorrectly replaced, the battery may explode. To prevent this, please do not replace the battery yourself. When the battery needs to be replaced, please contact your local GP distributor.

### Installation/Maintenance

- High voltage runs through the GP. Except for replacing the backlight, never take apart the GP, otherwise an electrical shock can occur.
- Do not modify the GP unit. Doing so may cause a fire or an electric shock.
- Do not use the GP in an environment where flammable gasses are present, since operating the GP may cause an explosion.



## CAUTIONS

### Installation/Maintenance

- Be sure to securely connect all cable connectors to the GP. A loose connection may cause incorrect input or output.



## CAUTIONS

### Wiring

- Ground the GP's FG line separately from other units' FG lines. Putting these FG lines too close may cause an electric shock or unit malfunction. Be sure to use a grounding resistance of  $100\Omega$  or less and a  $2\text{mm}^2$  or thicker wire, or your country's applicable standard.
- Be sure the GP's rated voltage is within the designated range, and that the power terminal lines are correctly attached. If the voltage supplied differs from the rated voltage, or incorrect wiring or grounding is performed, it may cause a fire or unit malfunction.
- Use only the designated torque to tighten the GP's terminal block screws. If these screws are not tightened firmly, it may cause a short-circuit, fire, or GP malfunction.
- Be careful that metal filings and wiring debris do not fall inside the GP, since they can cause a fire, GP malfunction, or incorrect unit operation.

### Display Device/CF Card

- The liquid crystal panel contains a powerful irritant and if for any reason the panel is damaged and this liquid contacts any part of your body, be sure to wash that area with running water for 15 minutes. If any of this liquid enters your eye, flush your eye for 15 minutes with running water and contact a physician.
- Prior to inserting or removing a CF Card, be sure the CF Card ACCESS lamp is not lit. If you do not, CF Card internal data may be damaged or lost.
- While a CF Card is being accessed, NEVER turn OFF or reset the GP, or insert or remove the CF Card. Prior to performing these operations, create and use a special GP application screen that will prevent access to the CF Card.

**Reference** *Refer to GP-PRO/PB III for Windows Tag Reference Manual (included in the screen editor software package)*

### Unit Disposal

- When this unit is disposed of, it should be done so according to your country's regulations for similar types of industrial waste.

# General Safety Precautions

---

## ■ About the Operation Environment

- *Do not strike the touch panel with a hard or pointed object, or press on the touch panel with too much force, since it may damage the touch panel or the display.*
- *Do not install the GP where the ambient temperature can exceed the allowed range. Doing so may cause the GP to malfunction or shorten its operation life.*
- *Do not restrict or limit the GP's naturally occurring rear-face ventilation, or store or use the GP in an environment that is too hot.*
- *Do not use this unit in areas where large, sudden temperature changes can occur. These changes can cause condensation to form inside the unit., possibly causing the unit to malfunction.*
- *Do not allow water, liquids, metal or charged particles to enter inside the GP's case, since they can cause either a GP malfunction or an electrical shock.*
- *Do not use or store the GP in direct sunlight, or in excessively dusty or dirty environments.*
- *Do not store or use the unit where strong jolting or excessive vibration can occur.*
- *Do not store or use the GP where chemicals (such as organic solvents, etc.) and acids can evaporate, or where chemicals and acids are present in the air.*

*Corrosive chemicals: Acids, alkalines, liquids containing salt*

*Flammable chemicals: Organic Solvents*

- *Do not use paint thinner or organic solvents to clean the GP, since they can cause either discoloration or a GP malfunction.*
- *Do not store or operate the LCD display in areas receiving direct sunlight, since the sun's UV rays may cause the LCD display's quality to deteriorate.*
- *Storing this unit in areas at a temperature lower than is recommended in this manual's specifications may cause the LCD display's liquid to congeal, which may damage the panel. Conversely, if the storage area's temperature becomes higher than the allowed level, the LCD's liquid will become isotropic, causing irreversible damage to the LCD. Therefore, be sure to store the panel only in areas where temperatures are within those specified in this manual.*
- *Do not connect or disconnect the communication cable between the GP and the host during power-ups.*



## ■ About the Screen Data

- *Due to the possibility of unexpected accidents, be sure to back up the GP's screen data regularly.*

## ■ About the GP's Display Panel

- *The GP's currently displayed data, its voltage<sup>\*1</sup> and brightness setting each affect the intensity of Contouring. (i.e, when some parts of the screen are brighter than others, creating a wavelike pattern)*
- *There are minute grid-points (dark and light) on the Display Panel's surface. This is part of the GP's design and not a defect.*
- *Extended shadows, or "Crosstalk" may appear on the sides of screen images. This is normal for an LCD display.*
- *Sometimes the display area may look as if the display colors have changed. This is a common attribute of LCD's and is not a defect.*
- *Displaying a single image for long periods can cause an afterimage to remain when the display is changed to another screen.*

To prevent this effect:

- *Use the GP's "Stand-by Mode", which automatically turns the screen OFF when there is no input for a specified period of time.*

### ▼Reference▲ 6.3.1 System Setup

- *Write "FFFFh" to the System Data Area's "Screen Display Off" address<sup>\*2</sup> to turn the screen display OFF when the following actions are not performed for the user's designated period of time.*
  - *Change Screen*
  - *Touch Screen*
  - *Alarm Display*
- *Do not display any single screen for a long period of time. Try to periodically change the screen display.*

---

*\*1 If the GP's voltage is at the very low end of its allowable range, it may effect the intensity of contouring.*

*\*2 The following addresses assume all System Data Area settings are entered. If they are not all entered, the correct word address may be different from those given here.*

*With the Direct Access Method — use System Data Area word address +9*

*With the Memory Link Method — use System Data Area word address +12*

▼Reference▲ *GP-PRO/PB III for Windows Device/PLC Connection Manual*

---

# GP-2300/2301 Series Model Names

The GP-2300/2301 Series refers to the following GP model numbers:

	Series	Model Name	Model Type	Comments	GP Type in Screen Creation Software
GP2000 Series	GP-2300 Series	GP-2300L	GP2300-LG41-24V	UL/c-UL (CSA) Approved, CE Marked	GP2300L
		GP-2300S	GP2300-SC41-24V		GP2300S
		GP-2300T	GP2300-TC41-24V		GP2300
	GP-2301 Series	GP-2301L	GP2301-LG41-24V		GP2301L
		GP-2301S	GP2301-SC41-24V		GP2301S
		GP-2301T	GP2301-TC41-24V		GP2301

## Package Contents

The GP's packing box contains the items listed below. Please check to confirm that all items shown below have been included.

■ **GP Unit (1)**

GP2300-LG41-24V/GP2300-SC41-24V/  
GP2300-TC41-24V/GP2301-LG41-24V/  
GP2301-SC41-24V/GP2301-TC41-24V

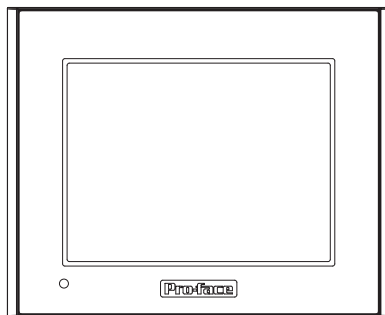

■ **Installation Gasket (1)**

<pre-installed>



■ **Installation Guide (1)**

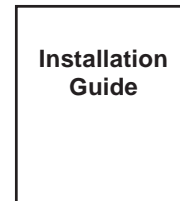

■ **Installation Fasteners (4/set)**

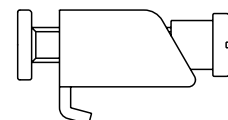

This unit has been carefully packed, with special attention to quality. However, should you find anything damaged or missing, please contact your local GP distributor immediately for prompt service.

# UL/c-UL (CSA) Application Notes

The GP2300-LG41-24V/GP2300-SC41-24V/GP2300-TC41-24V/GP2301-LG41-24V/GP2301-SC41-24V/GP2301-TC41-24V units are UL/c-UL(CSA) recognized components.

UL file no. E231702(UL60950+UL1604)

When applying for UL approval for a product that includes one of these GP units, please be sure to pay special attention to the fact that all products with built-in GP units require UL inspection of the combination of the GP and the product.

The GP components conform to the following standards:

- UL1604<sup>\*1</sup> and UL60950 Third Edition

Safety of Information Technology Equipment for use in Class I and II, Division 2, and Class III Hazardous (classified) locations.

- CAN/CSA-C22.2 No.60950-00 and No.213-M1987

Safety of Information Technology Equipment for use in Class I and II, Division 2, and Class III Hazardous (classified) locations.

GP2300-LG41-24V (UL Registration Model: 2980070-01)

GP2300-SC41-24V (UL Registration Model: 3180050-01)

GP2300-TC41-24V (UL Registration Model: 2980070-02)

GP2301-LG41-24V (UL Registration Model: 2980070-04)

GP2301-SC41-24V (UL Registration Model: 2980070-03)

GP2301-TC41-24V (UL Registration Model: 3180034-02)

## Installation Precautions

If the GP is mounted so as to cool itself naturally, please mount it on a vertical panel. Also, insure that the GP is mounted at least 100 mm away from any other adjacent structures or machine parts. If these conditions are not met, the heat generated by the GP's internal components may cause it to fail to meet UL standards.

## UL1604 - Compliance and Handling Cautions

1. Power and input/output wiring must be in accordance with Class I, Division 2 wiring methods - Article 501-4(b) of the National Electrical Code, NFPA 70 within the United States, and in accordance with Section 18-152 of the Canadian Electrical Code for units installed within Canada.
2. Suitable for use in Class I, Division 2, Groups A, B, C, and D Hazardous Locations.
3. WARNING: Explosion hazard - substitution of components may impair compliance to Class I, Division 2.
4. WARNING: Explosion hazard - when in hazardous locations, turn the power OFF before replacing or wiring modules.
5. WARNING: Explosion hazard - confirm that the power supply has been turned OFF before disconnecting equipment, or confirm that the location is not subject to the risk of explosion.

---

*\*1 GP2300-LG41-24V units with revision code "L" or later, GP2300-TC41-24V units with revision code "J" or later, GP2301-LG41-24V units with revision code "L" or later, and GP2301-SC41-24V units with revision code "K" or later are all UL1604 compliant. See "Revision Information" in page 14 for how to identify your unit's revision code.*

---

# CE Marking Notes

The GP2300-LG41-24V, GP2300-SC41-24V, GP2300-TC41-24V, GP2301-LG41-24V, GP2301-SC41-24V, and GP2301-TC41-24V are CE marked products that conform to EMC directives EN55011 Class A and EN61000-6-2.

\* For detailed CE marking information, please contact your local GP distributor.

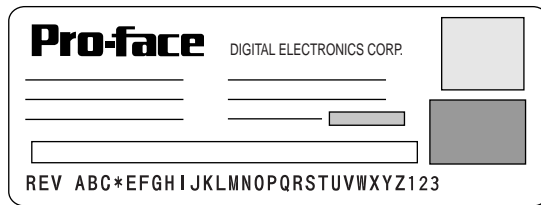

# Revision Information

Use the metallic label attached to the rear of the GP to identify your unit's revision code. This code is at the bottom of the label, to the right of "REV". In this example, the asterisk mark (\*) is in the "D" position, which means this unit's revision code is "D".



# Documentation Conventions

The list below describes the documentation conventions used in this manual.

Symbol	Meaning
	Indicates important information or procedures that must be followed for correct and risk-free software/device operation.
<b>GP Screen Editor</b>	Indicates the GP-PRO/PBIII for Windows screen editor software (version 6.10 or higher). GP-PRO/PB III for Windows Ver. 6.20 or higher is used for the GP-2301T. When using the GP-2300S, add-on software must be installed. This software can be downloaded from Pro-face's Web site. ( <a href="http://www.pro-face.com/">http://www.pro-face.com/</a> ) For information on how to confirm the version, refer to the "GP-PRO/PB for Windows Operation Manual", which is supplied with the GP screen editor software.
<b>PLC</b>	Abbreviation for Programmable Logic Controller.
<b>*1</b>	Indicates useful or important supplemental information.
<b>1) , 2)</b>	Indicates steps in a procedure. Be sure to perform these steps in the order given.
	Provides useful or important supplemental information.
	Refers to useful or important supplemental information.

# Chapter 1 Introduction

1. Prior to Operating the GP
2. System Design
3. Accessories

## 1.1 Prior to Operating the GP

---

Be sure to follow these steps when creating projects for the GP unit.

- 1 Preparation** Before using the GP, check that all required hardware is present and read all specification, wiring, and installation information.  
**Reference** *Chapter 2, "Specifications" and Chapter 3, "Installation and Wiring"*
- 2 Screen Design** Create a sample screen and design a Tag layout, with the Screen layout sheets and Tag lists provided in the Editor software.  
**Reference** *GP-PRO/PBIII for Windows Operation Manual*
- 3 Select GP and PLC types** Using the input areas provided, select the GP and the PLC types to be used.  
**Reference** *GP-PRO/PBIII for Windows Operation Manual*  
**Reference** *GP-PRO/PBIII for Windows Tag Reference Manual*
- 4 Create Screen/ Run Screen Setup** Setup the screen and tags in your screen editing software according to your Screen Design.  
**Reference** *GP-PRO/PBIII for Windows Operation Manual and Tag Reference Manual*
- 5 Transfer Screen Data** Transfer the data from the Screen editor software on your PC to the GP unit using the Data Transfer Cable.  
**Reference** *GP-PRO/PBIII for Windows Operation Manual*
- 6 GP/Host Connection** Set up the GP so that it can receive data from the Host (PLC).  
**Reference** *Chapter 6, "Initializing the GP", and GP-PRO/ PBIII for Windows Device/PLC Connection Manual*
- 7 Connect the GP** Link the GP with the host (PLC) using the appropriate connection cable (different cables may be necessary for different hosts), and then operate the unit.  
**Reference** *GP-PRO/PBIII for Windows Device/PLC Connection Manual*



## 1.2 System Design

### 1.2.1 GP-2300 Series System Design

The following diagram represents the standard items connected to the GP-2300 Series unit.

#### ■ GP RUN Mode Peripherals

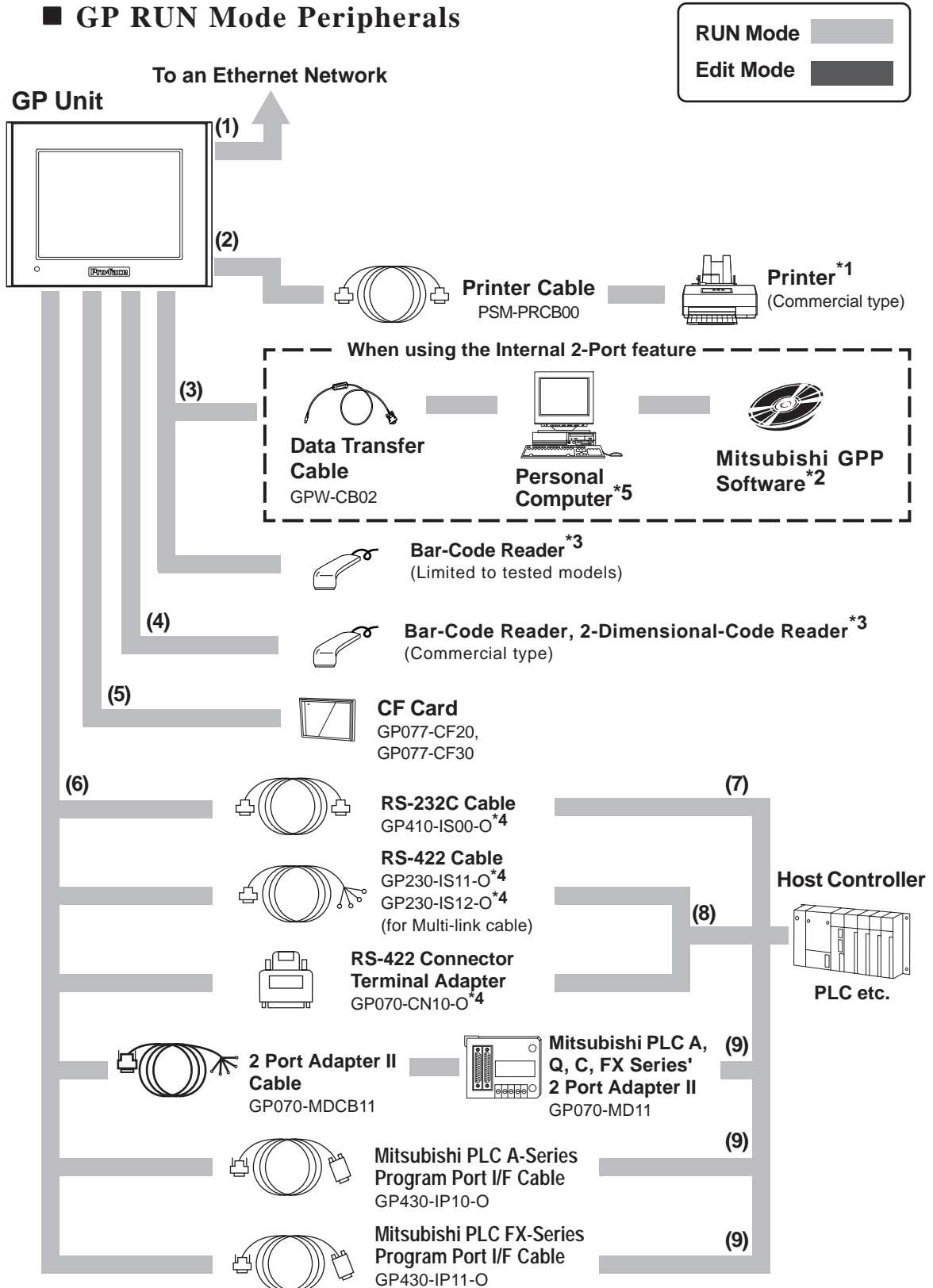

## ■ GP Edit Mode Peripherals

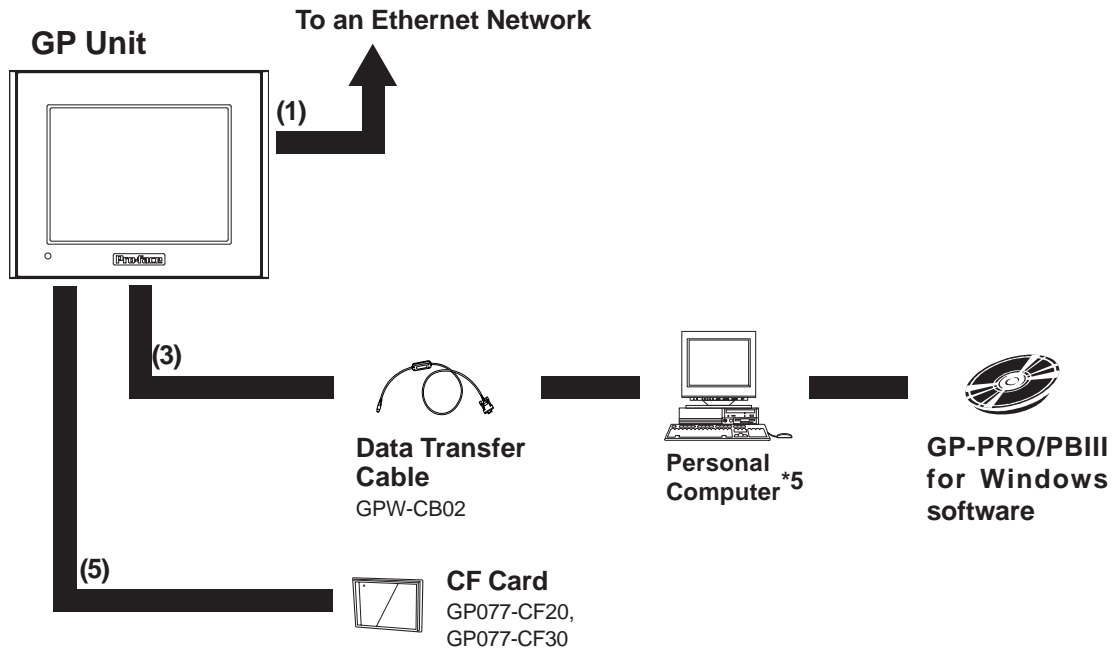

GP Interfaces	PLC Interfaces
(1) Ethernet	(7) RS-232C Port
(2) Printer	(8) RS-422 Port
(3) Tool Connector	(9) Programming Port
(4) Expansion Serial	
(5) CF Card	
(6) Serial Interface	

\*1 Compatible with NECPC-PR201/PL , EPSON ESC/P24-J84(C), HP Laser Jet PCL 4 command printers, EPSON PM/Stylus (6-color ink), EPSON Stylus (4-color ink) printers or their equivalent that are designed for MS-DOS. Printers designed solely for Windows may not be used. Certain printers containing both Windows and DOS drivers may be used. For details, please contact your printer's manufacturer or sales outlet.

\*2 About certain types and models of PLC and software, see:

**Reference** GP-PRO/PBIII for Windows Device/PLC Connection Manual (included with the screen editor software)

\*3 See Page 1-6 for recommended units.

\*4 Certain types and models of PLCs cannot be connected.

**Reference** GP-PRO/PBIII for Windows Device/PLC Connection Manual (included with the screen editor software)

\*5 Certain types and models of PCs cannot be connected.

**Reference** GP-PRO/PBIII for Windows Operation Manual (included with the screen editor software)

## 1.2.2 GP-2301 Series System Design

The following diagram represents the standard items connected to the GP-2301 Series unit.

### ■ GP RUN Mode Peripherals

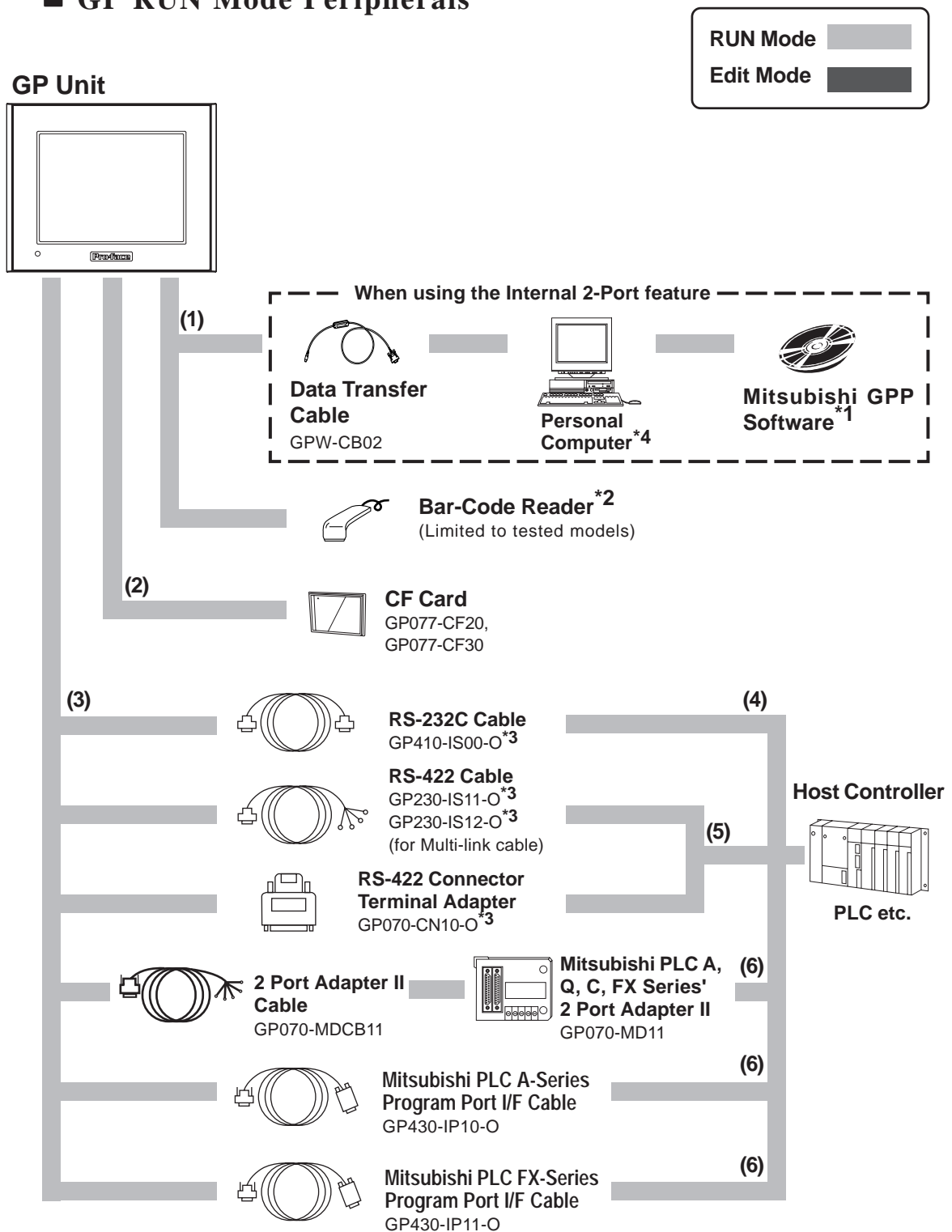

## ■ GP Edit Mode Peripherals

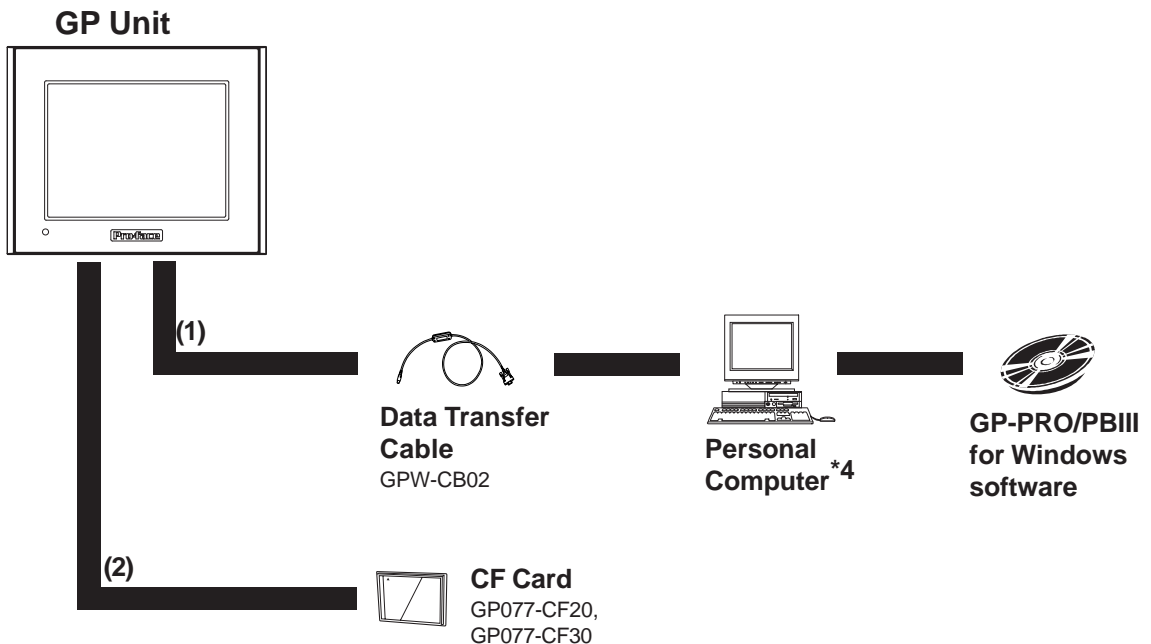

GP Interfaces	PLC Interfaces
(1) Tool Connector	(4) RS-232C Port
(2) CF Card	(5) RS-422 Port
(3) Serial Interface	(6) Programming Port

\*1 About certain types and models of PLC and software, see:

▼ **Reference** ▲ *GP-PRO/PBIII for Windows Device/PLC Connection Manual (included with the screen editor software)*

\*2 See Page 1-6 for recommended units.

\*3 Certain types and models of PLCs cannot be connected.

▼ **Reference** ▲ *GP-PRO/PBIII for Windows Device/PLC Connection Manual (included with the screen editor software)*

\*4 Certain types and models of PCs cannot be connected.

▼ **Reference** ▲ *GP-PRO/PBIII for Windows Operation Manual (included with the screen editor software)*

# Chapter 1 - Introduction

## ■ Recommended Units

The following tables list I/O devices that have been confirmed to be compatible with the GP. If you connect a device other than those listed below, be sure to confirm that the connection functions correctly using an actual unit.



**Recommended units are subject to change without notice.**

### ◆ Bar Code Readers (Connected to Tool Connector)

Manufacturer	Model	Type	Description
Aimex Corporation	BR-331 PC2	Pen	
OPT Electronics	OPT-1105-RSK 98 Set	Touch Scanner (Read Width: 60mm)	
	OPT-5105-RSK 98 Set	Touch Scanner (Read Width: 80mm)	
	OPL-6735-RSK 98 Set	Touch Scanner (Read Width: 100mm)	
Tohken	TCD-5510M	Touch Scanner (Read Width: 65mm)	
	TCD-5510L	Touch Scanner (Read Width: 82mm)	
	TCD-5510W	Touch Scanner (Read Width: 105mm)	
NEC Infrontia	BCK5435-STA	Touch Scanner (Read Width: 56mm)*1*2	Includes Y cable for connection cable
	BCK5535-STA	Touch Scanner (Read Width: 85mm)*1*2	Includes Y cable for connection cable

\*1 Be sure to use the Y cable included with the unit and connect it between GP unit and a bar code reader. Data cannot be read correctly, if a non-"Y" cable is used, or if the bar code reader is connected directly to the GP unit.

\*2 The following settings must be entered prior to using the bar code reader with a GP unit.

1) Set the CAPS.

2) Add the Carriage Return (CR) in the Postamble's settings.

For the details about these settings, please refer to the Installation Guide included with the bar cord unit.

## ◆ Bar Code Readers (Connected to Expansion Serial Interface)\*<sup>1</sup>

GP-2300 Series Only

Manufacturer	Model	Type	Remarks
Aimex Corporation	BR-730RS	Pen	Battery powered
	BR-530RS	Pen	Requires separately sold BB-60 for power.
	BW-665RS	Touch Scanner (Read Width: 65mm)	
OPT Electronics	OPT-1125-RS232C	Touch Scanner (Read Width: 60mm)	Requires separately sold DC5300T for power.
	OPT-5125-RS232C	Touch Scanner (Read Width: 80mm)	
	NFT-7175-L-RS232C	Fixed Type (Read width: 60mm)	
Olympus Symbol	LS4004	Laser Scanner	Includes power supply.
	LS4004i	Laser Scanner	
	LS6004	Laser Scanner	
	LSH3502AHV	Laser Scanner	
Keyence Co.	BL-80R	Touch Scanner (Read Width: 105mm)	
Denso Co.	HC36TR	Touch Scanner (Read Width: 61mm)	For power: separately sold P-200 unit.
	HC61TR	Touch Scanner (Read Width: 61mm)	For connector cable: separately sold KRS-423-XF1K (Sanwa Supply)

\*1 Confirm that the Expansion serial interface's settings match those of the connected device.  
See 6.4.6 Expansion Serial Setup.

## ◆ 2-Dimensional Code Reader (Connected to Expansion Serial Interface)\*<sup>1</sup>

GP-2300 Series Only

Manufacturer	Model	Power Supply
Tohken	THIR-3000	ESA-1220A (Sold separately)
	THIR-3000H	
Denso	QS20H	contains an external AC adapter
	QS20H-I	

\*1 Confirm that the Expansion serial interface's settings match those of the connected device.  
See 6.4.6 Expansion Serial Setup.

## 1.3 Accessories

All optional equipment listed here is produced by Digital Electronics Corporation.

### ■ Available Software

Product Name	Model No.	Description
GP-PROPB III C-Package02 (GP-PRO/PB III for Windows Ver. 6.10 or later *1)	GPPRO-CNT01W-P02	Software to be used to create the GP's screen data. Installed in a personal computer.

\*1 GP-PRO/PB III for Windows Ver. 6.20 or higher is used for the GP-2301T  
When using the GP-2300S, add-on software must be installed. This software can be downloaded from Pro-face's Web site. (<http://www.pro-face.com/>)

### ■ Tool Connector

Product Name	Model No.	Description
Screen Data Transfer Cable	GPW-CB02	Connects the GP to a personal computer. Transfers screen data and user program(s).

### ■ Serial Interfaces

Product Name	Model No.	Description
RS-232C cable*1	GP410-IS00-O	Interface cables between the host (PLC) and the GP.
RS-422 cables*1	GP230-IS11-O	
	GP230-IS12-O (for Multi-link)	
Extension cable*1	CA1-EXCBL/D25-01	Extends GP RS-232C/422 serial interface cables (Approx. 1 ft.)
RS-422 Connector Terminal Adapter*1	GP070-CN10-O	Conversion adapter to convert serial data to RS-422 format
2 Port Adapter II	GP070-MD11	Interface unit that allows use of both GP and Mitsubishi A, Q, C and FX series peripheral equipment.
2 Port Adapter II Cable	GP070-MDCB11	Connects the GP to 2 Port Adapter II.
Mitsubishi A Series Programming Port I/F cable	GP430-IP10-O	Connects directly to Mitsubishi's PLC Programming port. Simultaneous use of programming console, however, is not possible.
Mitsubishi FX Series Programming Port I/F cable	GP430-IP11-O	

\*1 For detailed information about the range of connectable PLC manufacturers and models,

**Reference** *GP-PRO/PBIII for Windows Device/PLC Connection Manual*

### ■ Printer Interface Cable (GP-2300 Series only)

Product Name	Model No.	Description
Printer Cable	PSM-PRCB00	Cable designed to connect the GP and a commercial type printer.

## ■ CF Card Items

Product Name	Model No.	Description
CF Card	GP077-CF20	GP Series CF Card (16MB)
	GP077-CF30	GP Series CF Card (32MB)
CF Card Adaptor	GP077-CFAD10	CF Card Adapter for the PCMCIA Slot.

## ■ Screen Protection

Product Name	Model No.	Description
Screen Protection Sheet (Hard Type)	PS300-DF00	Disposable, dirt-resistant sheet for the GP's screen. The GP's touch panel can be operated with this cover sheet attached. (5 sheets/set)

## ■ Maintenance Items

They are available separately as optional maintenance items.

Product Name	Model No.	Description
Backlight	PS300-BU00	Replacement Backlight for the GP-2300L, GP-2300S, GP-2301L and GP-2301S.
Installation Fastener	GP070-AT01	Fasteners to attach the GP to a panel. (4 fasteners/set)
Installation Gasket	PS300-WP00	Provides a moisture resistant seal when installing the GP. Same as the seal included in the GP's original equipment package.
Connector Cover	PS-BH00	Attaches to GP rear face connectors. (3/set)



# *Memo*

# Chapter

# 2 Specifications

1. General Specifications
2. Functional Specifications
3. Interface Specifications
4. Part Names and Functions
5. Dimensions

## 2.1 General Specifications

---

### 2.1.1 Electrical

---

<b>Rated Voltage</b>	DC 24V
<b>Rated Voltage Range</b>	DC19.2V to 28.8V
<b>Allowable Voltage Drop</b>	10ms or less
<b>Power Consumption</b>	22W or less
<b>In-Rush Current</b>	30A or less
<b>Voltage Endurance</b>	AC1,000V 20mA for 1 minute (between charging and FG terminals)
<b>Insulation Resistance</b>	20M $\Omega$ or higher at DC500V (between charging and FG terminals)

## Chapter 2 - Specifications

### 2.1.2 Environmental

<b>Ambient Operating Temperature (Cabinet Interior) (Panel Face)</b>	0°C to +50°C <sup>*1</sup>
<b>Storage Temperature</b>	-20°C to +60°C
<b>Operating Humidity</b>	10%RH to 90%RH (Non condensing, wet bulb temperature: 39°C or less)
<b>Storage Humidity</b>	10%RH to 90%RH (Non condensing, wet bulb temperature: 39°C or less)
<b>Atmospheric Endurance (GP Operation Altitude)</b>	800hPa to 1,114hPa (2,000 meters or lower)
<b>Air Purity (Dust)</b>	0.1mg/m <sup>3</sup> or less (non-conductive levels)
<b>Pollution Degree</b>	Pollution Degree 2
<b>Corrosive Gasses</b>	Free of corrosive gasses
<b>Vibration Resistance</b>	IEC61131-2 compliant <u>When vibration is NOT continuous</u> 10Hz to 57Hz 0.075mm, 57Hz to 150Hz 9.8m/s <sup>2</sup> <u>When vibration is continuous</u> 10Hz to 57Hz 0.035mm, 57Hz to 150Hz 4.9m/s <sup>2</sup> X, Y, Z directions for 10 times (80min.)
<b>Noise Immunity (via noise simulator)</b>	Noise Voltage: 1,000Vp-p Pulse Duration: 1µs Rise Time: 1ns
<b>Electrostatic Discharge Immunity</b>	6kV (complies with EN 61000-4-2 Level 3)

*\*1 The LCD displays of GP-2300L, GP-2300S, GP-2301L and GP-2301S may occasionally blur when they are used for hours at over 40°C ambient operating temperature. This is a temporal phenomenon. After the temperature returns to normal, the normal display will be restored. The GP's operation will not be affected even though the display is blurred.*

### 2.1.3 Structural

<b>Grounding</b>	100Ω or less, or your country's applicable standard
<b>Ratings</b> <sup>*1</sup> (For front panel of installed unit)	Equivalent to IP65f (JEM 1030), NEMA#250 Type4X/12
<b>External Dimensions</b>	W171mm [6.73in] x H138mm [5.43in] x D60mm [2.36in]
<b>Weight</b>	1.2kg (2.6lb) or less
<b>Cooling Method</b>	Natural air circulation

*\*1 The front face of the GP unit, installed in a solid panel, has been tested using conditions equivalent to the standards shown in the specification. Even though the GP unit's level of resistance is equivalent to these standards, oils that should have no effect on the GP can possibly harm the unit. This can occur in areas where either vaporized oils are present, or where low viscosity cutting oils are allowed to adhere to the unit for long periods of time. If the GP's front face protection sheet becomes peeled off, these conditions can lead to the ingress of oil into the GP and separate protection measures are suggested. Also, if non-approved oils are present, it may cause deformation or corrosion of the front panel's plastic cover. Therefore, prior to installing the GP be sure to confirm the type of conditions that will be present in the GP's operating environment. If the installation gasket is used for a long period of time, or if the unit and its gasket are removed from the panel, the original level of the protection cannot be guaranteed. To maintain the original protection level, be sure to replace the installation gasket regularly.*

## 2.2 Functional Specifications

### 2.2.1 Display

	GP2300-LG41-24V GP2301-LG41-24V	GP2300-SC41-24V GP2301-SC41-24V	GP2300-TC41-24V GP2301-TC41-24V
<b>Type</b>	Monochrome LCD	STN type color LCD	TFT type color LCD
<b>Resolution</b>	320 x 240pixels		
<b>Effective Display Area</b>	W115.2mm [4.54in.] x H86.4mm [3.40in.]		
<b>Colors</b>	Black and White, 2 levels of gray/ Black and White, 8 levels of gray <sup>*1</sup> (Color switching is done via software)	64 colors/3-speed blink	256/No blink <sup>*2</sup> , 64 colors/3-speed blink (Color switching is done via software)
<b>Backlight</b>	CCFL (Service life: 50,000 hrs. at 25°C and 24hr. operation)		
<b>Contrast Adjustment</b>	8 levels of adjustment available via touch panel.		
<b>Brightness Adjustment</b>	4 levels of adjustment available via touch panel.		
<b>Language Fonts</b>	ASCII: (Code page 850) Alphanumeric (incl. Eur. characters) Chinese: (GB2312-80 codes) simplified Chinese fonts Japanese: ANK 158, Kanji : 6,962 (JIS Standards 1 & 2) (including 607 non-kanji characters) Korean: (KSC5601 - 1992 codes) Hangul fonts Taiwanese: (Big 5 codes) traditional Chinese fonts		
<b>Character Sizes</b> <sup>*3</sup>	8X8, 8X16, 16X16 and 32X32 dot fonts		
<b>Font Sizes</b>	Width can be expanded 1 to 8 times. Height can be expanded 1/2 <sup>*4</sup> , 1 to 8 times.		
<b>Text</b>	8x8 dots	40 Char. x 30 rows	
	8x16 dots	40 Char. x 15 rows	
	16x16 dots	20 Char. x 15 rows	
	32x32 dots	10 Char. x 7 rows	

*\*1 In order to set the monochrome (eight levels of gray) mode, GP-PRO/PB III for Windows Ver. 6.2 or later is required. Depending on the color used, selecting MONOCHROME 8 HUES may cause the GP unit's screen to flicker and make it difficult to distinguish colors. Confirm that all colors display as expected prior to using this mode.*

*\*2 Changing the "Colors" setting to "256 colors" will disable the blink feature on all of your project's screens. If you wish to use the blink feature, select "64 colors".*

*\*3 The display font will differ depending on which (language) character, or which size you select. Also, if GP-PRO/PBIII Ver. 5.0 or later software is used, high quality fonts are available with 16x16 or larger characters.*

#### **Reference** 6.9 Font Setting

*\*4 Only available when using the Japanese character set.*

## Chapter 2 - Specifications

### 2.2.2 Memory

	GP-2300 Series	GP-2301 Series
<b>Application</b>	2MB FLASH EPROM	1MB FLASH EPROM
	[Approx. 640 screens at 3.2KB/screen]	[Approx. 320 screens at 3.2KB/screen]
<b>Data Backup</b>	256KB SRAM	128KB SRAM
	[uses a rechargeable lithium battery] <sup>*1</sup>	

*\*1 A Lithium battery's lifetime is:  
10 years when the battery's ambient temperature is 40 °C or less.  
4.1 years when the battery's ambient temperature is 50 °C or less.  
1.5 years when the battery's ambient temperature is 60 °C or less.  
When used for backup:(without main power)  
Approximately 60 days, with a fully charged battery  
Approximately 6 days, with a 10% charged battery*

### 2.2.3 Touch Panel • Clock

<b>Touch Panel Resolution</b>	16 x 12 keys/screen 1 or 2 point push - selectable
<b>Clock Accuracy</b>	± 65 seconds/ month (at room temperature)



**Note:** The GP's internal clock has a slight error. At normal operating temperatures and conditions, with the GP operating from its lithium battery, the degree of error is 65 seconds per month. Variations in operating conditions and battery life can cause this error to vary from -380 to +90 seconds per month. For systems where this degree of error will be a problem, the user should be sure to monitor this error and make adjustments when required.

**Reference** Chapter 6.7 Set Up Time

### 2.2.4 Interfaces

---

#### ■ GP-2300 Series

<b>Serial Interface</b>	Asynchronous Transmission : RS-232C/RS-422, Data Length: 7 or 8 bits, Stop Bit: 1 or 2 bits, Parity: None, Odd or Even, Data Transmission Speed: 2,400bps to 115,200bps
<b>Expansion Serial Interface</b>	Asynchronous Transmission : RS-232C, Data Length: 7 or 8 bits, Stop Bit: 1 or 2 bits, Parity: None, Odd or Even, Data Transmission Speed: 2,400bps to 38,400bps
<b>Ethernet Interface</b>	IEEE802.3, 10BASE-T
<b>Tool Connector</b>	Asynchronous TTL level nonprocedural command I/F <During screen file development> Used for transferring data to and from the GP application software and the GP. Used for data transfer with the 2-Port feature. <During Operation> Used for a variety of devices, including a bar-code reader.
<b>CF Card Interface</b>	1 slot
<b>Printer Interface</b>	Compatible with NEC PC-PR201/PL , EPSON ESC/P24-J84(C), HP Laser Jet PCL 4 command, EPSON PM/Stylus (6-color ink), EPSON Stylus (4-color ink) compatible printers *1

*\*1 Printers with only Windows drivers cannot be used. However, certain types of printers with both Windows and DOS drivers can be used. For details, contact your local GP distributor.*

#### ■ GP-2301 Series

<b>Serial Interface</b>	Asynchronous Transmission : RS-232C/RS-422, Data Length: 7 or 8 bits, Stop Bit: 1 or 2 bits, Parity: None, Odd or Even, Data Transmission Speed: 2,400bps to 115,200bps
<b>Tool Connector</b>	Asynchronous TTL level nonprocedural command I/F <During screen file development> Used for transferring data to and from the GP application software and the GP. Used for data transfer with the 2-Port feature. <During Operation> Used for a variety of devices, including a bar-code reader.
<b>CF Card Interface</b>	1 slot

## 2.3 Interface Specifications

### 2.3.1 Serial Interfaces

This interface can be either RS-232C or RS-422. Connects GP to Host/PLC. (Socket-Type Connector)

Pin Assignments	Pin #	Signal Name	Condition
	1	FG	Frame ground
	2	SD	Send data (RS-232C)
	3	RD	Receive data (RS-232C)
	4	RS	Request send (RS-232C)
	5	CS	Clear send (RS-232C)
	6	DR	Data Set Ready (RS-232C)
	7	SG	Signal ground
	8	CD	Carrier detect (RS-232C)
	9	TRMX	Termination (RS-422)
	10	RDA	Receive data A (RS-422)
	11	SDA	Send data A (RS-422)
	12	NC	No connection (Reserved)
	13	NC	No connection (Reserved)
	14	VCC	5V±5% output 0.25A
	15	SDB	Send data B (RS-422)
	16	RDB	Receive data B (RS-422)
	17	RI	Ring Indicate (RS-232C)
	18	CSB	Clear send B (RS-422)
	19	ERB	Enable receive B (RS-422)
	20	ER	Enable receive (RS-232C)
	21	CSA	Clear send A (RS-422)
	22	ERA	Enable receive A (RS-422)
	23	NC	No connection (Reserved)
	24	NC	No connection (Reserved)
	25	NC	No connection (Reserved)

Recommended Connector: Dsub25pin plug XM2A-2501 <made by OMRON>

Recommended Cover: Dsub25pin cover XM2S-2511 <made by OMRON>

Jack Screws: XM2Z-0071 <made by OMRON>



- Use rough metric type M2.6x0.45 p threads used to secure the cable's set screws.

**Recommended Cable:** CO-MA-VV-SB5PX 28AWG <made by HITACHI Cable Ltd.>

- To confirm your PLC's connection specifications , refer to

**Reference** *GP-PRO/PBIII for Windows Device/PLC Connection Manual* (included with the screen creation software)

When creating your own cable, follow the instructions listed below:

<With RS-422>



- The following pairs of pin #'s must be connected to each other.

#18 (CSB) <—> #19 (ERB)

#21 (CSA) <—> #22 (ERA)

- When connecting the RS-422 cable and the #9 (TRMX) and #10 (RDA) points, a termination resistance of 100Ω is added between RDA and RDB.
- When making a cable for a Memory Link system, be sure to use a 4-wire type.

<With RS-232C>

- Do not use the following pins: 9 (TRMX), 10 (RDA), 11 (SDA), 15 (SDB), 16 (RDB), 18 (CSB), 19 (ERB), 21 (CSA), 22 (ERA).
- The #1 (FG) terminal should only be connected if it is required by the device being connected to.



- This unit's serial port is not isolated, therefore, it is important that you connect the SG (Signal Ground) terminals. If this is not done, the RS422 circuit may be damaged.***
- Pin 14 (VCC) DC5V output is not protected. To prevent damage or unit malfunction, be sure to use only the designated level of current.***

### 2.3.2 Expansion Serial Interface

This interface is used for RS-232C data transfer. The GP-2301 Series unit is not equipped with this interface. (Plug-Type Connector)

Pin Assignments	Pin No.	Signal Name	Signal Direction	Condition
	1	CD	Input	Carrier detect (RS-232C)
	2	RD	Input	Receive data (RS-232C)
	3	SD	Output	Send data (RS-232C)
	4	ER	Output	Enable receive (RS-232C)
	5	SG	—	Signal Ground
	6	DR	Input	Data Set Ready (RS-232C)
	7	RS	Output	Request Send (RS-232C)
	8	CS	Input	Clear send (RS-232C)
	9	RI/VCC	Input/Output	Ring Indicate (RS-232C) +5V±5% 0.25A

Recommended Connector: Dsub9pin socket XM2D-0901<made by OMRON>

Recommended Cover: Dsub9pin cover XM2S-0913<made by OMRON>

Jack Screws: XM2Z-0073<made by OMRON>



**Note:** Use inch type screws (#4-40UNC) as set screws.



- Since Pin#9(RI/VCC) is unprotected, be sure to keep the output current within the rated range.***
- The GP-2301T does not have an expansion serial I/F.***



## Chapter 2 - Specifications

### 2.3.3 Printer Interface

When connecting a printer, use Digital's printer cable (PSM-PRCB00). The GP-2301 Series units are not equipped with this interface.

Pin Assignments	Pin #	Signal Name	Condition
	1	GND	Ground
	2	RESERVE	Reserved
	3	PDB5	Data Signal
	4	PDB4	Data Signal
	5	PDB3	Data Signal
	6	GND	Ground
	7	SLCT	Select Status (Input) <sup>*1</sup>
	8	PDB0	Data Signal
	9	PSTB	Strobe Signal (Output)
	10	BUSY	Busy Signal (Input)
	11	PDB7	Data Signal
	12	PDB6	Data Signal
	13	GND	Ground
	14	ERROR	Printer Error (Input) <sup>*1</sup>
	15	GND	Ground
	16	PDB2	Data Signal
	17	PDB1	Data Signal
	18	PE	Paper Runout <sup>*1</sup>
	19	INIT	Initialization Signal (Output)
	20	GND	Ground

*\*1 Not used in the GP's software.*

## 2.4 Part Names and Functions

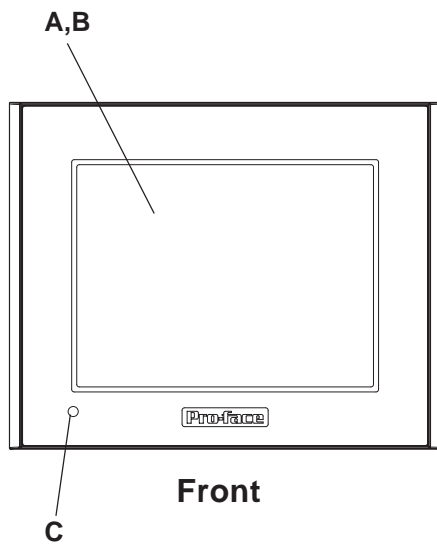

### A: Display Panel

The GP monitor screen displays the screen setup and corresponding host (PLC) data.

GP2300-LG41-24V .... Monochrome LCD

GP2300-SC41-24V .... STN Color LCD

GP2300-TC41-24V .... TFT Color LCD

GP2301-LG41-24V .... Monochrome LCD

GP2301-SC41-24V .... STN Color LCD

GP2301-TC41-24V .... TFT Color LCD

### B: Touch Panel

Performs any screen change operations and sends data to the PLC.

### C: Status LED

This LED reflects the GP's condition.

Color	Indicates
OFF	No power input
Green	Normal operation
Orange	Backlight is burned out

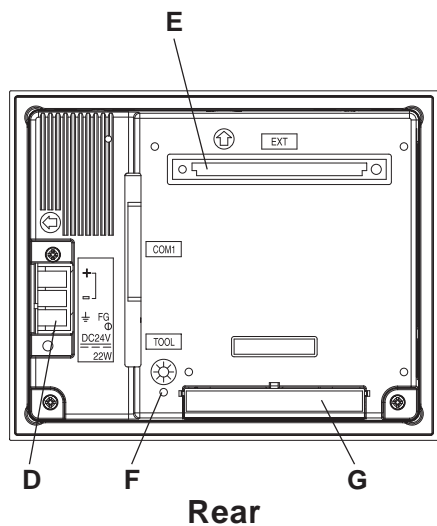

### D: Power Input Terminal Block

Connects the power cord.

### E: Expansion Unit I/F (EXT)

Connects expansion units with communication features.

### F: CF Card Access Lamp

If the CF Card Cover is closed when the CF Card is inserted, the LED lamp turns ON. The LED lamp will remain turned ON even if the CF Card Cover is opened while the GP accesses the CF Card.

### G: CF Card Cover

Open this cover to the CF Card Slot. When accessing the CF Card, this cover must be closed.



**Note:** When accessing the CF Card, this cover must be closed.

## Chapter 2 - Specifications

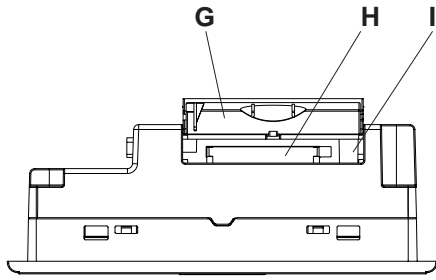

**Bottom**

### H: CF Card Slot

Insert the CF Card in this slot.

### I: DIP Switches

The following chart explains the GP2300/2301 units' DIP switch parameters.

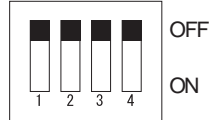

Dip Switch	Function	ON	OFF	Note
1	This Dip switch setting controls the startup from a CF Card.	Startup from CF Card is enabled.	Startup from CF Card is disabled.	CF Card with startup data required.
2	Reserved	—	—	Keep these switches OFF
3	Reserved	—	—	
4	This setting controls the forced closing of the CF Card cover.	Forced close enabled.	Forced close disabled.	Used when CF Card cover is damaged.

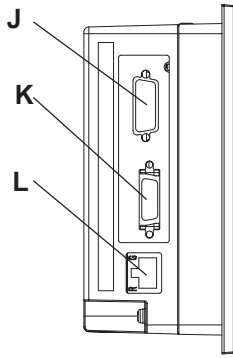

**Left**  
**(GP-2300 Series Unit)**

**J: Expansion Serial Interface (COM2)**

Uses Dsub9 pin's RS-232C cable.  
(GP-2300 Series units only.)

**K: Printer Interface (PRINT)**

Connect the printer cable here. Recommended cable: Digital Electronic Corporation PSM-PRCB00 Cable.  
(GP-2300 Series units only.)

**L: Ethernet Interface (10BASE-T)**

The LED will change (turn ON, blink) according to the communication status.  
(GP-2300 Series units only.)

Color	Indicates
Orange	Blinks during data transfer / Turns ON when power ON.
Green	Turns ON when linked.

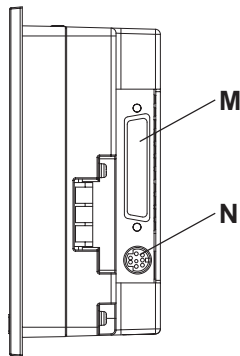

**Right**

**M: Serial Interface (COM1)**

Used for the Dsub25 pin's RS-232C and RS-422 cables. Is connected to the Host (PLC.)

**N: Tool Connector (TOOL)**

The Data Transfer cable, or Bar Code Reader can be connected here.

## 2.5 Dimensions

### 2.5.1 GP-2300/2301 Series External Dimensions

Unit: mm [in.]

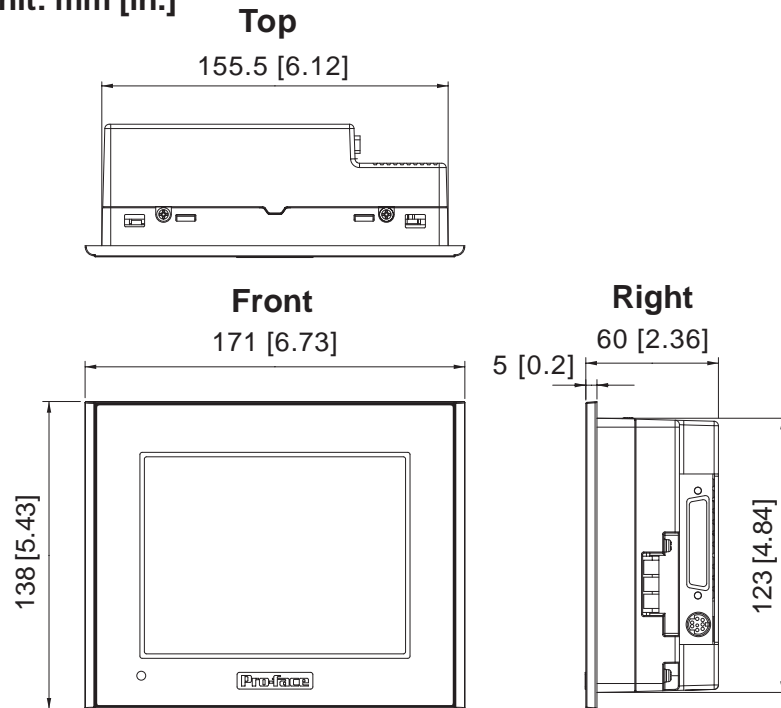

The following drawing shows the GP-2300 Series unit with installation fasteners.

Unit: mm [in.]

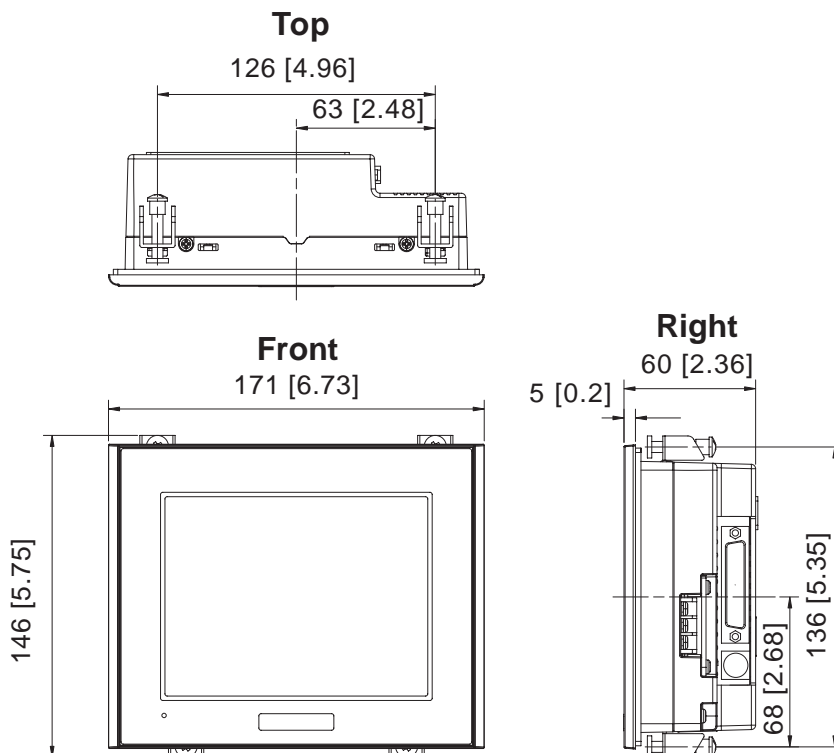

The following drawing shows the GP-2300 Series unit with cables.

Unit: mm [in.]

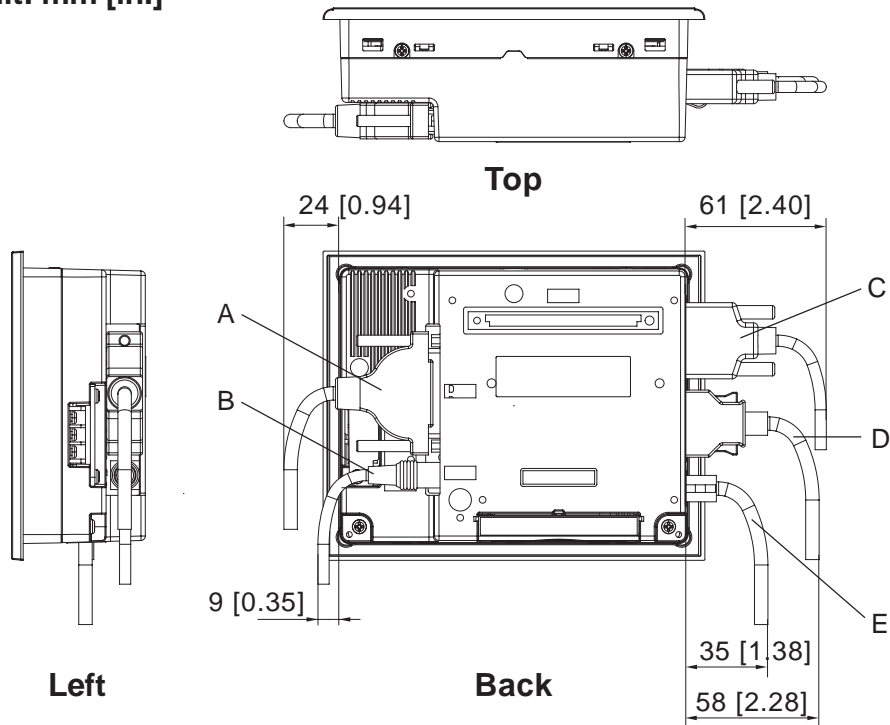

The dimensions given here are for the cables in the following chart. Use the values for reference when designing the enclosure for the GP.

	Interface	Cable	Model
A	COM1	Multi Link Cable	GP230-IS12-0
B	TOOL	Transfer Cable	GPW-CB02
C	COM2	RC-232C Cable	Commercial Type
D	PRINTER	Printer Cable	PSM-PRCB00
E	10BASE-T Ethernet	10BASE-T Ethernet Cable	Commercial Type

## 2.5.2 Panel Cut Dimensions

Unit: mm [in.]

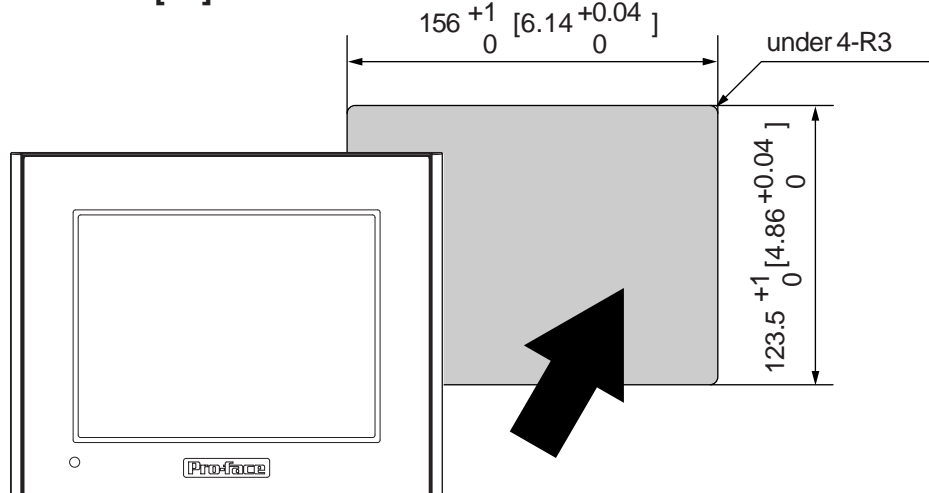

## Chapter 2 - Specifications

### 2.5.3 Installation Fasteners

---

Unit: mm [in.]

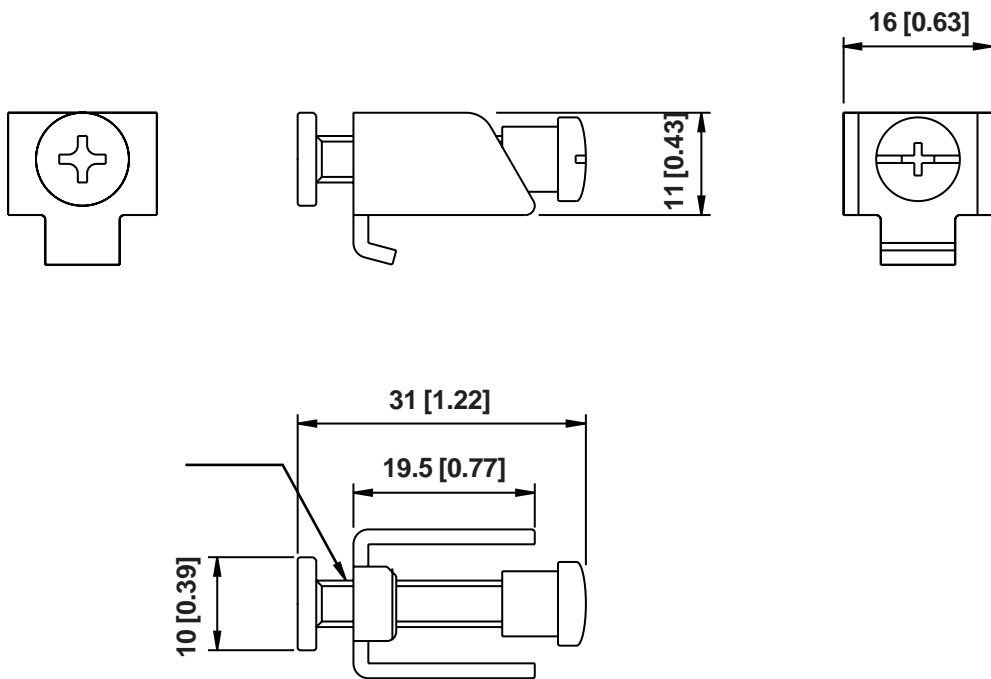

# Chapter

## 3 Installation and Wiring

1. Installation
2. Wiring Precautions
3. Tool Connector
4. Ethernet Cable Connector
5. CF Card Insertion and Removal

### 3.1 Installation

---

#### 3.1.1 Installation Procedures

---

Follow the steps given below when installing the GP.

##### ■ Check the Installation Gasket's Seating

It is strongly recommended that you use the installation gasket, since it absorbs vibration in addition to repelling water.

Place the GP on a level surface with the display panel facing downward. Check that the GP's installation gasket is seated securely into the gasket's groove, which runs around the perimeter of the panel's frame.

For details about installing the gasket, refer to

**Reference** [8.1.2 Installation Gasket Check/Replacement](#)



- **Before installing the GP into a cabinet or panel, check that the installation gasket is securely attached to the unit.**
- **A gasket which has been used for a long period of time may have scratches or dirt on it, and could have lost much of its dust and drip resistance. Be sure to change the gasket periodically (or when scratches or dirt become visible).**
- **Be sure to use gasket model PS300-WP00.**
- **Be sure the gasket's seam is not inserted into any of the unit's corners, only in the straight sections of the groove. Inserting it into a corner may lead to its eventually tearing.**

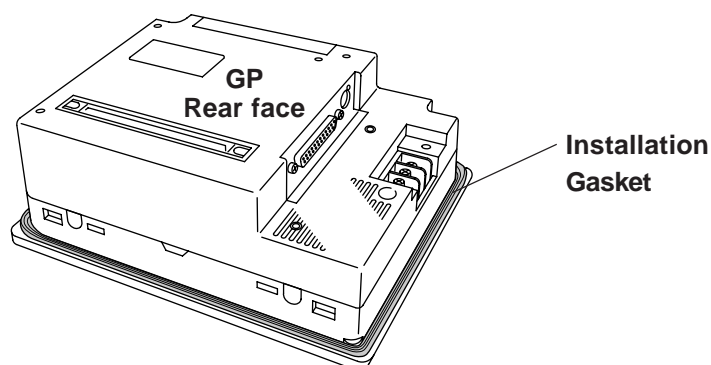



## Chapter 3 - Installation and Wiring

### ■ Creating a Panel Cut

Create the correct sized opening required to install the GP, using the installation dimensions given.

**Reference** *2.5.2 Panel Cut Dimensions*

The installation gasket, installation brackets and attachment screws are all required when installing the GP.

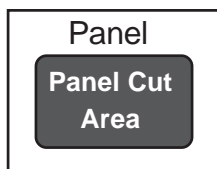

**Note:** Check that the installation panel or cabinet's surface is flat, in good condition and has no jagged edges. Also, if desired, metal reinforcing strips can be attached to the inside of the panel, near the Panel Cut, to increase the panel's strength.



**Panel thickness should be from 1.6mm [0.06in.] to 10mm [0.4in.]. Decide the panel's thickness based on the level of panel strength required.**

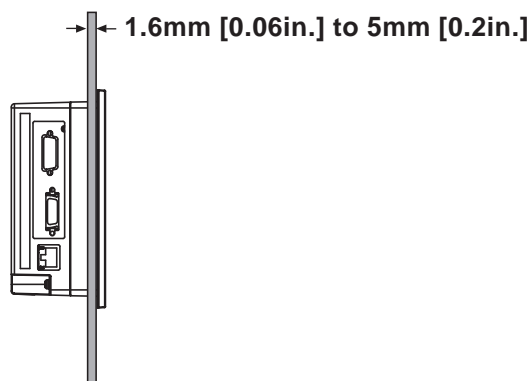

**For easier maintenance, operation, and improved ventilation, be sure to install the GP at least 100 mm [3.94 in.] away from adjacent structures and other equipment.**

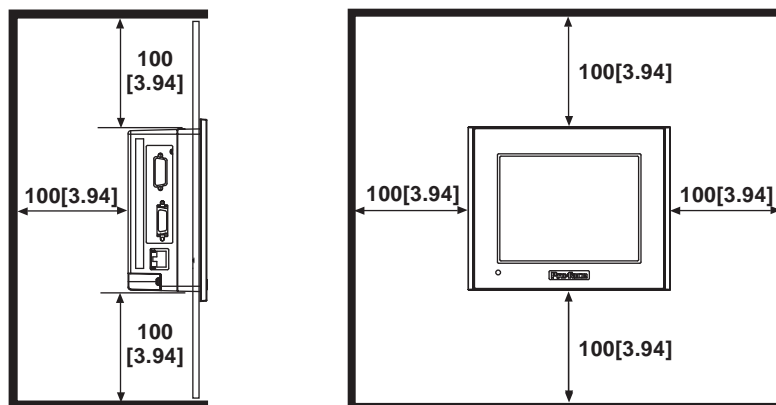

## Chapter 3 - Installation and Wiring



- ***Be sure that the ambient operation temperature and the ambient humidity are within their designated ranges. (When installing the GP in a cabinet or enclosure, the term “ambient operation temperature” indicates the cabinet or enclosure’s internal temperature.***

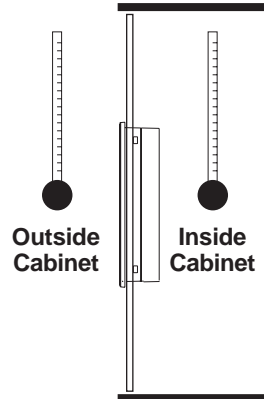

- ***Be sure that heat from surrounding equipment does not cause the GP to exceed its standard operating temperature.***
- ***When installing the GP in a slanted panel, the panel face should not incline more than 30°.***

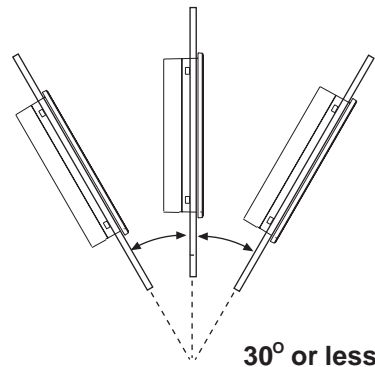

- ***When installing the GP in a slanted panel, and the panel face inclines more than 30°, the ambient temperature must not exceed 40 °C. You may need to use forced air cooling (fan, A/C) to ensure the ambient operating temperature is 40 °C or below.***
- ***When installing the GP vertically, position the unit so that the Power Input Terminal Block is also vertical.***

## Chapter 3 - Installation and Wiring

### ■ Installing the GP

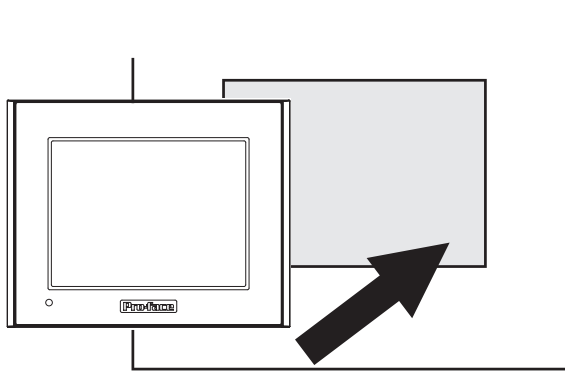

- 1) Insert the GP into the panel cut out, as shown here.

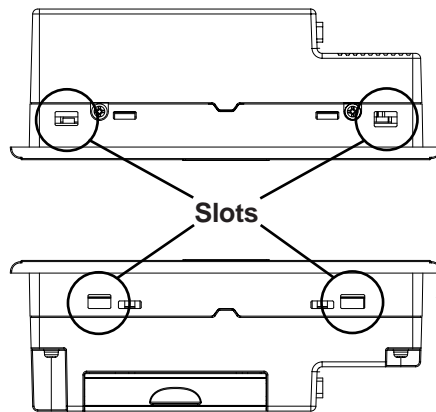

- 2) Insert the installation fasteners into the GP's insertion slots, at the top and bottom of the unit. (total: 4 slots)

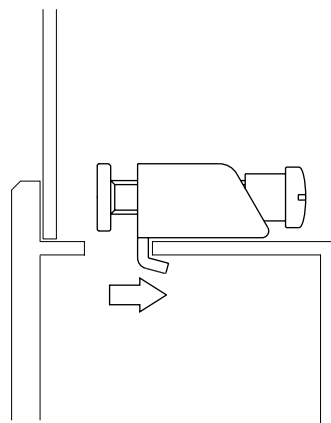
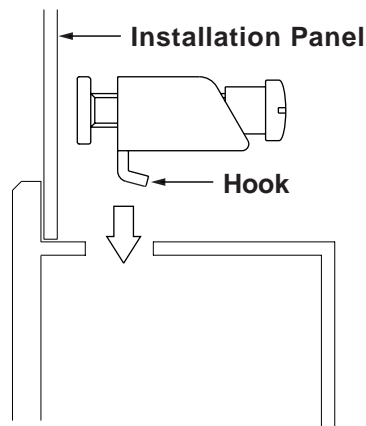

- 3) Insert each of the fasteners shown below. Be sure to pull the fastener back until it is flush with the rear of the attachment hole.

## Chapter 3 - Installation and Wiring

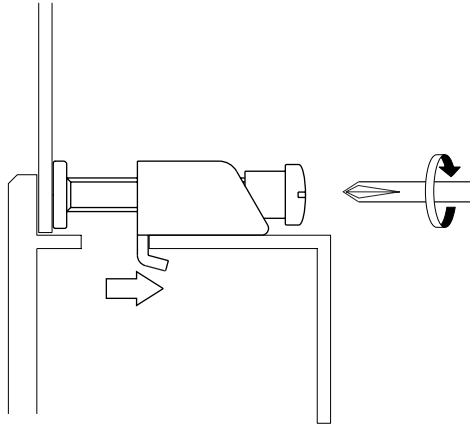

- 4) Use a Phillips screwdriver to tighten each fastener screw and secure the GP in place.



***A torque of only 0.5 N•m is sufficient to tighten these screws. Do not use too much force, since it may damage the GP unit.***

## 3.2 Wiring Precautions

### 3.2.1 Connecting the Power Cord



## WARNINGS

- To avoid an electric shock, be sure the power cord is unplugged from the power outlet when connecting the power terminals to the GP unit.
- The GP2300-LG41-24V/GP2300-SC41-24V/GP2300-TC41-24V and GP2301-LG41-24V/GP2301-SC41-24V/GP2301-TC41-24V are designed to use only DC24V power. Using any other level of power can damage both the power supply and the GP unit.
- Since the GP is not equipped with the power switch, be sure to connect a breaker type power switch to the GP's power cord.
- Be sure to ground the GP's FG terminal. Failure to do so can lead to an electrical shock or GP malfunction.



- *To prevent the Ring Terminals from causing a short when the terminal block attachment screws are loosened, be sure to use sleeve-type Ring Terminals.*
- *When the FG terminal is connected, be sure the wire is grounded. Not grounding the GP unit will result in excessive noise. Use your country's applicable standard for grounding.*

**Reference** 3.2.3 Grounding

- *The SG and FG terminals are connected internally in the GP unit.*
- *When connecting the SG line to another device, be sure that the design of the system/connection does not produce a shorting loop.*



- Wherever possible, use thick wires (max 2mm<sup>2</sup>) for power terminals, and twist the exposed wire ends when connecting the Ring Terminals.
- Please use the following size crimp-on type Ring Terminals.

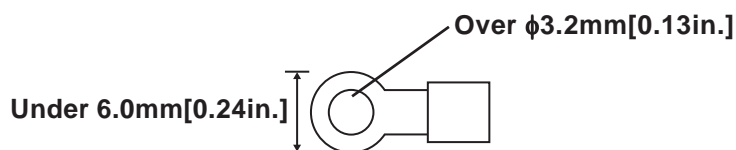

### ■ Connecting the Power Supply Terminals

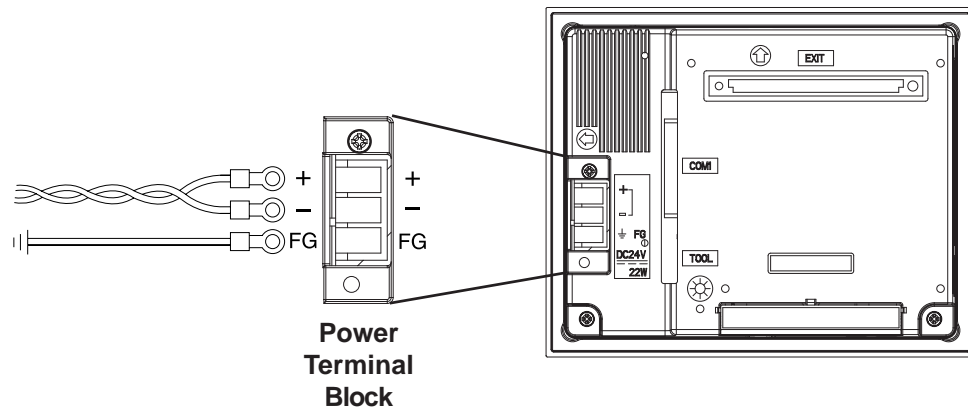

<b>+</b>	Positive Line
<b>-</b>	Negative Line
<b>FG</b>	Grounding Terminal connected to the GP chassis

- 1) Be sure that the GP's power cord is not plugged in to the power supply.
- 2) Remove the Terminal Strip's clear plastic cover.
- 3) Remove the screws from the three (3) middle terminals, position the Ring Terminals as shown above and reattach the screws.
- 4) Reattach the Terminal Strip's clear plastic cover.



- **Check each wire to make sure the connections are correct.**
- **A torque of only 0.5 to 0.6 N•m is required to tighten an attachment screw.**

## Chapter 3 - Installation and Wiring

### 3.2.2 Connecting the Power Supply

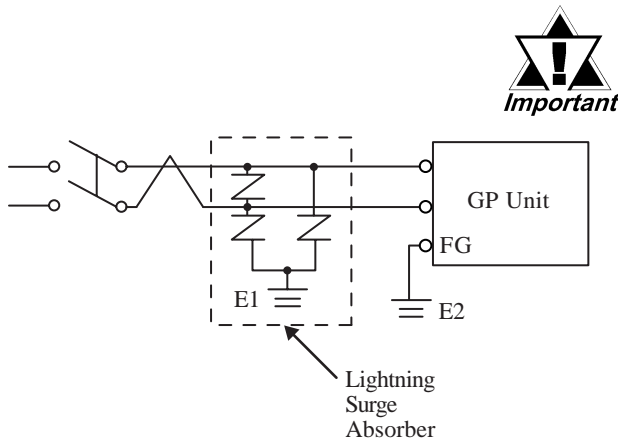
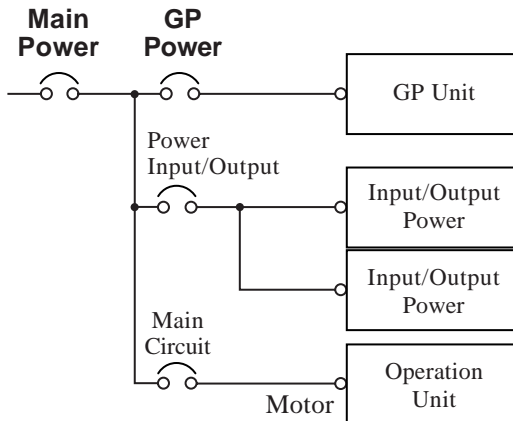
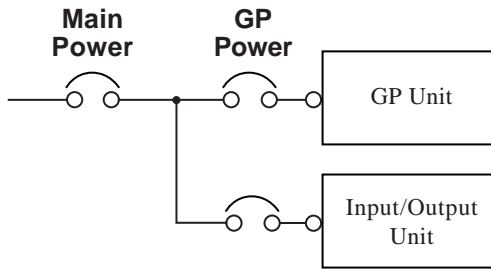

- When supplying power to the GP unit, please separate the input/output and operation unit lines, as shown.
- To increase the noise resistance quality of the power cable, simply twist each power wire before attaching the Ring Terminal.
- The power supply cable must not be bundled or positioned close to main circuit lines (high voltage, high current), or input/output signal lines.
- Connect a lightning surge absorber, as shown in the diagram, to deal with power surges.
- To avoid excess noise, make the power cable as short as possible.
- **Be sure to ground the surge absorber (E1) separately from the GP unit (E2).**
- **Select a surge absorber that has a maximum circuit voltage greater than that of the peak voltage of the power supply.**

## 3.2.3 Grounding



### CAUTION

Do not use common grounding, since it can lead to an accident or machine breakdown.

(a) Exclusive Grounding (BEST) \*1

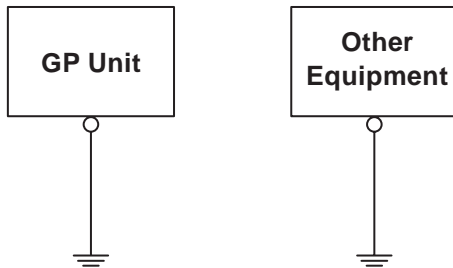

Connect the FG terminal found at the back of the GP to an exclusive ground. [diagram (a)].



- Check that the grounding resistance is less than 100Ω.
- FG and SG terminals are internally connected in the GP.
- When connecting the SG line to another device, be sure that the design of the system/connection does not produce a shorting loop.
- The grounding wire should have a cross sectional area greater than 2mm<sup>2</sup>. Create the connection point as close to the GP unit as possible, and make the wire as short, as possible. When using a long grounding wire, replace the thin wire with a thicker wire, and place it in a duct.

(b) Common Grounding (OK) \*1

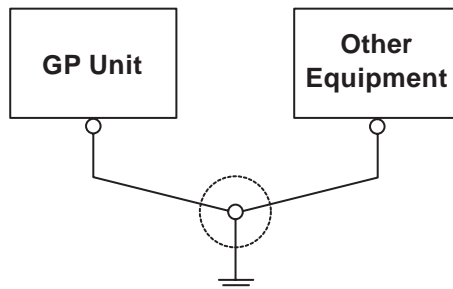

(c) Common Grounding (Not OK)

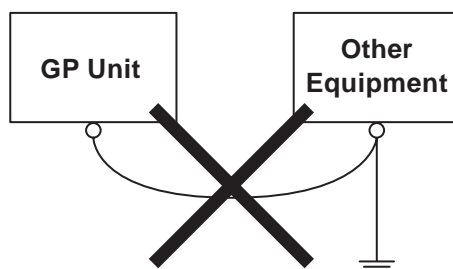

If exclusive grounding is not possible, use a common connection point. [diagram (b)]



If the equipment does not function properly when grounded, disconnect the ground wire from the FG terminal.

## 3.2.4 I/O Signal Line Placement

- Input and output signal lines must be separated from the power control cables for operating circuits.
- If this is not possible, use a shielded cable and connect the shield to the GP's frame.

\*1 Use a grounding resistance of less than 100Ω and a 2mm<sup>2</sup> or greater thickness wire, or your country's applicable standard. For details, contact your local GP distributor.



### 3.3 Tool Connector

The GP's Data Transfer Cable, Memory Loader, or the Bar Code Reader can be attached to the GP unit's Tool Connector.



## WARNING

To prevent an electric shock, unplug the GP unit's power cord from the main power supply prior to attaching or detaching any connector(s) to or from the GP.

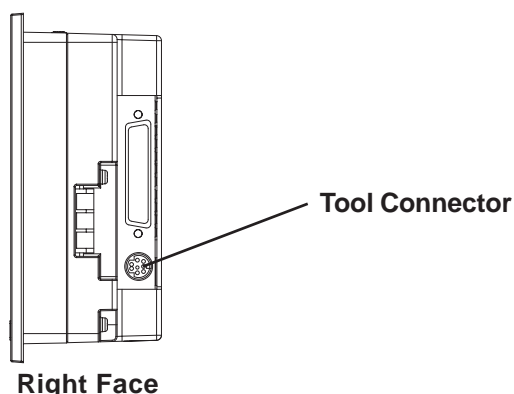

*When the Bar Code Reader uses a separate power supply:*

- Turn the Bar Code Reader ON before turning the GP ON.
- Turn the GP OFF before turning the Bar Code Reader OFF.

### 3.4 Ethernet Cable Connector

Use the following drawing to locate your GP unit's Ethernet connector. The GP Ethernet interface is IEEE802.3 compatible, and transmits data at 10Mbps. (The Ethernet I/F is not equipped on the GP2301 Series.)

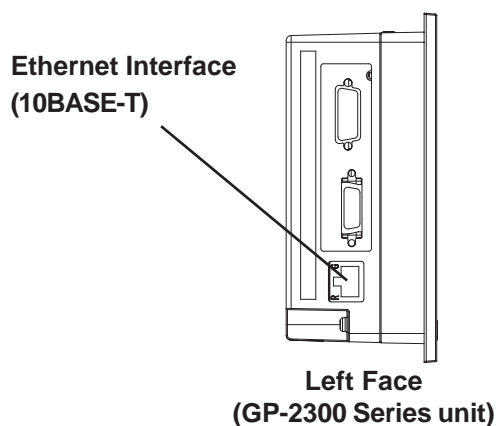

- It is strongly recommended that your Ethernet network is installed by a trained engineer.
- 1:1 connections using a cross cable may not be possible depending on the type of personal computer and network card you are using. Make sure to use a hub for connection.

## 3.5 CF Card Insertion and Removal



### CAUTIONS

When using the GP Unit and a CF Card, follow the precautions below:

- Prior to inserting or removing a CF Card, be sure to turn the GP unit's CF Card ACCESS switch OFF and to confirm that the ACCESS lamp is not lit. If you do not, CF Card internal data may be damaged or lost.
- While a CF Card is being accessed, NEVER turn OFF or reset the GP, or insert or remove the CF Card. Prior to performing these operations, create and use a special GP application screen that will prevent access to the CF Card.

**Reference** Refer to *GP-PRO/PB III for Windows Tag Reference Manual* (included in the screen editor software package)

- Prior to inserting a CF Card, familiarize yourself with the CF Card's front and rear face orientation, as well as the CF Card connector's position. If the CF Card is not correctly positioned when it is inserted into the Muilt Unit, the CF Card's internal data and the GP unit may be damaged or broken.
- Be sure to use only CF Cards manufactured by the Digital Electronics Corporation. The CF Card's internal data may be damaged when using another manufacturer's CF Card.
- Once GP data is lost, it cannot be recovered. Since accidental data loss can occur at any time, be sure to back up all GP screen and CF Card data regularly.
- Be sure to follow the instructions given below to prevent the CF Card's internal data from being destroyed or a CF Card malfunction from occurring:
  - DO NOT bend the CF Card.
  - DO NOT drop or strike the CF Card against another object.
  - Keep the CF Card dry.
  - DO NOT touch the CF Card connectors.
  - DO NOT disassemble or modify the CF Card.

## Chapter 3 - Installation and Wiring

### ■ Inserting the CF Card

Use the following steps to insert the CF Card in the GP.

- 1) Open the CF Card Cover upward.

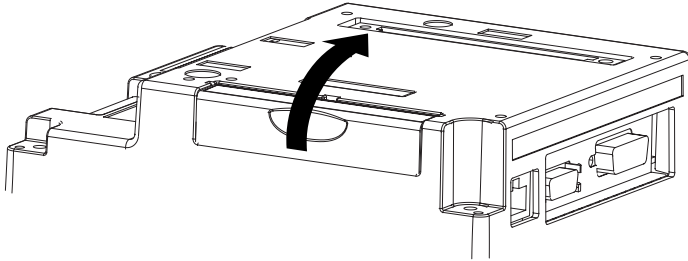

- 2) Insert the CF Card in the CF Card Slot, until the eject button is pushed forward.

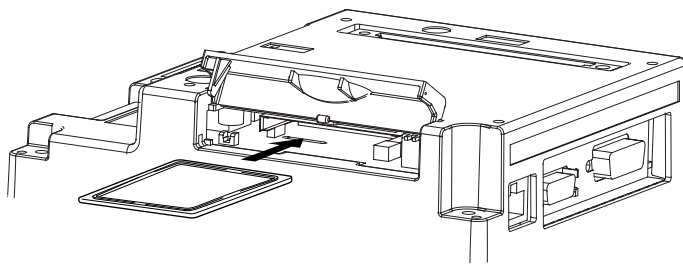

- 3) Close the cover. (As shown.)

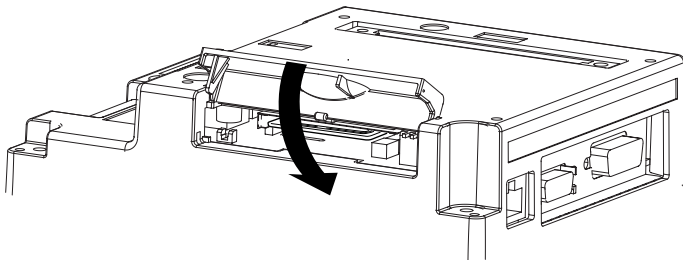

- 4) Confirm that the CF Card Access LED turns ON.



**Note:**

The GP cannot access the CF Card if the CF Card cover is already opened. If however, the CF Card Cover is opened while the GP is accessing the CF Card, access will not be interrupted.

### ■ Removing the CF Card

Simply reverse the steps shown in the previous “Inserting CF Card” explanation. Prior to depressing the eject button to remove the CF Card, confirm that the CF Card Access LED is turned OFF.

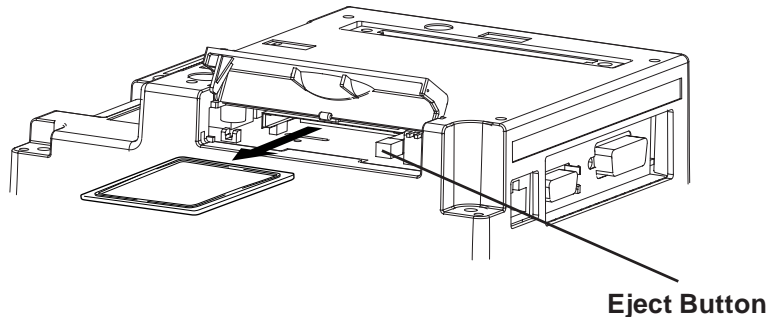

### 3.5.1 CF Card Handling

---

The CF Card has a data overwrite limit of approximately 100,000 times. Therefore, be sure to back up all CF Card data regularly to another storage media. (100,000 times assumes the overwriting of 500KB of data in DOS format)

Two methods are available for backing up data. After using either method (1) or method (2), use your PC to save your data to the CF Card.

#### (1) If your PC is equipped with a PC Card Slot

To view CF Card data on a personal computer, first, insert the CF Card into a CF Card Adapter.

#### (2) If your PC is NOT equipped with a PC Card slot

Use a commercially available PC Card Reader, or a CF Card Reader.

<Recommended CF Card Reader>

Manufacture Name	Model	Connection Type
I-O DATA DEVICE, INC.	CardDock-CF/P	Parallel port



- Depending on the setup of your PC, it is possible that the Card Reader may not operate correctly.
- All of Pro-face's CF Card operation testing has been performed using the following equipment. The connection between a personal computer and the CF Card reader has been tested using a Windows® compatible machine. This does not mean, however, that all Windows® compatible machines can be used. Please contact your PC or CF Card reader manufacturer directly for details.

# *Memo*

# Chapter 4 Data Transfer

1. Serial Data Transfer
2. Ethernet Data Transfer
3. CF Memory Loader Tool

This chapter explains following three (3) methods of transferring data created with the GP screen creation software to or from the GP.

- Transfer data via the data transfer cable to or from your GP.
- Transfer data via an Ethernet network to the GP.
- Transfer data via the CF Card to or from your GP using the CF Memory Loader Tool.

## 4.1 Serial Data Transfer

---

The following explains how to connect Pro-face's data transfer cable to your PC and to the GP.

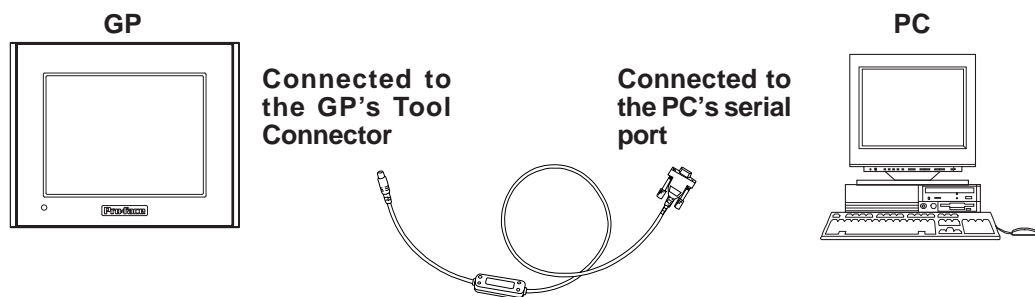

- Note:**
- Pro-face's transfer cable (GPW-CB02) is sold separately. The transfer cable package does not include the PC's interface converting adapter.
  - When using the PC with the Dsub 25pin socket side interface, a connector conversion adapter is required. Use the straight line type conversion adapter.

**Recommended units:**

Abel Co. AA833

Sanwa Supply Co. D09-9F25F

- When using a PC equipped with a half-pitch 14pin socket interface, a conversion adapter is required.

**Recommended unit:**

Arroz Co. ZR01-024

## Chapter 4 - Data Transfer

Transfer screen data from your PC, via the GP screen creation software.

**Reference** For details about the GP screen creation software, refer to **GP-PRO/PBIII for Windows Operation Manual** (included in the GP screen editor software)

### ■ To Transfer Data to a Completely New GP

Connect the GP to your PC via the data transfer cable, and then turn the GP ON. The “Initial Start Mode” screen will appear on the GP and you can transfer screen from your PC. The screen will change to the “Transfer” screen automatically.

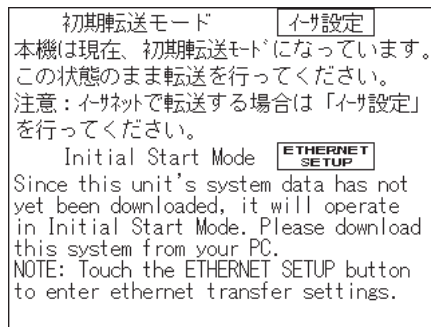

GP-2300 Series

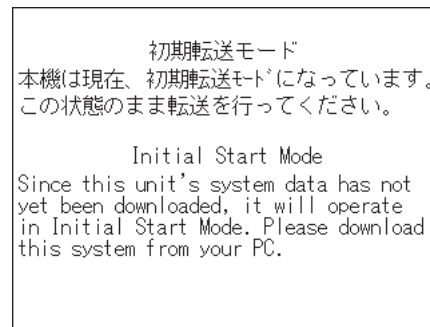

GP-2301 Series

### ■ After Completing Data Transfer using GP setup\*1

Transfer screen data from the GP screen creation software, and select the “Transfer” mode.

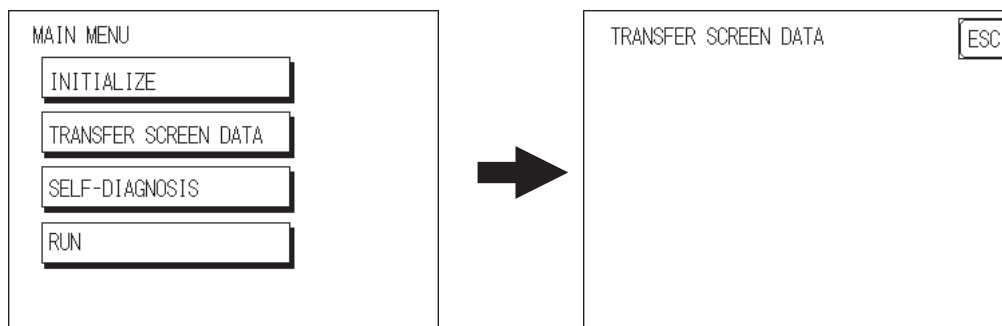

During data transfer, the “SETUP Transfer” and “Now Transferring - Please Wait” messages will appear. When these messages disappear, screen data transfer is completed.

If you wish to stop data transfer, simply cancel it from your PC’s GP screen creation software.

If you try to set up the GP after data transfer, the OFFLINE mode’s “Main Menu” will appear. If you do NOT set up the GP, the screen designated in “INITIAL SETTINGS/SCREEN SETUP/INITIAL SCREEN FILE NO.” will appear and the screen will change to operation (RUN) mode.

---

*1\* Here, the term “Set up” refers to the process of sending GP screen, system program and protocol program information to the GP via the screen creation software, so that the GP can be used as an operator interface.*

---



**Do NOT disconnect the GP's power supply, turn OFF the PC, or disconnect the GP's transfer cable during the data transfer. If you do, an error may occur when the GP is started.**



**Note:** If the GP screen creation software's "GP SYSTEM SETTINGS" data is transferred to the GP, the OFFLINE mode "INITIAL SETTINGS" data will be overwritten.



## 4.2 Ethernet Data Transfer

The GP-2300 Series units are equipped with the Ethernet I/F which allows you to set up the GP via an Ethernet network, as well as transfer GP screen data. (The GP-2301 Series units are not equipped with the Ethernet I/F.)



**When using the Ethernet communication protocol, you must specify the port number for the protocol as +10 or higher than the value specified in this section. Otherwise, the setup or screen data transfer via Ethernet is disabled.**

After you connect an Ethernet cable to the GP's Ethernet I/F, the GP will appear on the Ethernet network.

### ■ Transferring Data to a Completely New GP

#### ◆ Setting Up the IP Address Manually and sending data to a GP

Touch the “ETHERNET SETUP” button on the GP2300 Initial Start Mode screen.

▼ **Reference** ▲ 6.5.4 Ethernet Setup

Use this method if the GP has been previously set up and data transferred to it.

初期転送モード イサ設定

本機は現在、初期転送モードになっています。  
この状態のまま転送を行ってください。  
注意：イサネットで転送する場合は「イサ設定」を行ってください。

Initial Start Mode ETHERNET SETUP

Since this unit's system data has not yet been downloaded, it will operate in Initial Start Mode. Please download this system from your PC.  
NOTE: Touch the ETHERNET SETUP button to enter ethernet transfer settings.

➔

ETHERNET SETUP SET ESC

MY IP ADDR. [ 0 ] . [ 0 ] . [ 0 ] . [ 0 ]

SUBNET MASK [ 0 ] . [ 0 ] . [ 0 ] . [ 0 ]

MY PORT NO. 8000

GATEWAY [ 0 ] . [ 0 ] . [ 0 ] . [ 0 ]

#### ◆ Using a previously set up IP Address to send data <sup>\*1</sup>

When the settings in the “Ethernet Setup” screen are not specified and data is sent, the GP unit's factory-set IP Address settings are used.

If you choose to use the factory-set IP address, be sure to designate the PC's IP Address from “10.255.255.1” to “10.255.255.254” and the subnet mask as “255.0.0.0”.

Use the GP-PRO/PBIII for Windows software to transfer the data.

▼ **Reference** ▲ “GP-PRO/PBIII for Windows Operation Manual” (included in the GP screen editor software package)

---

*\*1 Be sure to use 2-Way2000 version 3.10 or higher. This version data can be seen in the bottom left-hand corner of the [Initial Start Mode] screen.*

---

### ■ When transferring data using the GP setup\*<sup>1</sup> is completed

#### ◆ How to manually set an IP address and transfer data

Set an IP address in the OFFLINE mode “INITIAL SETTING / OPERATING ENVIRONMENT SETTING / EXTENSION SETTING / ETHERNET INFORMATION SETTING”. However, in case that an IP address is preset in the PC’s screen editor software, the IP address is set in the GP. If the transferred IP address is used, setting the GP’s IP address again in the OFFLINE mode is not needed.

Set an IP address in the GP's through “INITIAL SETTING / OPERATING ENVIRONMENT SETTING / EXTENSION SETTING / ETHERNET INFORMATION SETTING” menu.

When you transfer screen data from your PC to the GP while the GP is in RUN mode, the screen will change automatically to “Ethernet Mode”. If it does not, you will need to manually change the GP screen to Ethernet Mode, via the following screen.

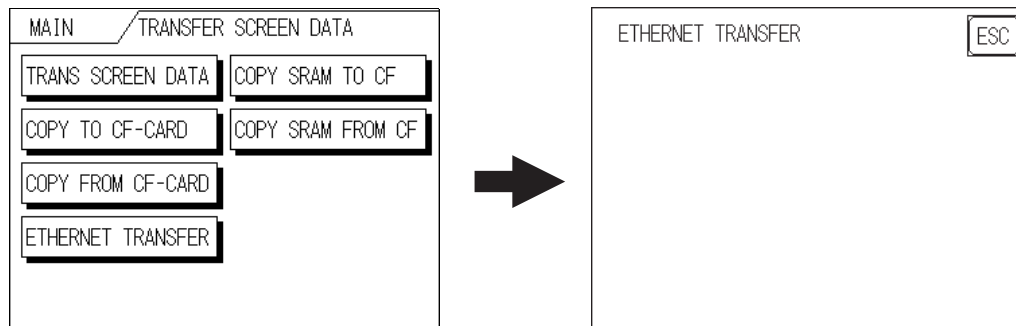

You can now transfer data from your PC’s screen editor software.

**Reference** *GP-PRO/PBIII for Windows Operation Manual*

#### ◆ How to transfer data using a previously-set IP address\*<sup>2</sup>

When transferring data without first setting up an IP address in the screen editor software, your GP unit's factory-set IP address is used.

When transferring data using your GP unit's factory-set IP address, be sure to set “10.255.255.1” to “10.255.255.254” as your PC’s IP address, and “255.0.0.0” for your PC's subnet mask.

The data transfer method is the same as when the IP address was manually set.

---

\*1 Here, the term “Set up” refers to the process of sending GP screen, system program and protocol program information to the GP via the screen editor software, so that the GP can be used as an operator interface.

\*2 Be sure to use 2-Way2000 version 3.10 or higher. This version data can be seen in the bottom left-hand corner of the [Initial Start Mode] screen.

---

# Chapter 4 - Data Transfer

## 4.2.1 Checking the IP Address

---

Use the following procedure to check the IP Address assigned to the GP and some consideration/precautions.

- 1) Display the menu bar. For instructions on how to display the menu bar, **▼Reference▲** *6.4.3 Set Up Touch Panel*
- 2) Click on the left-side 1/3 cell of the menu bar to display the next menu.

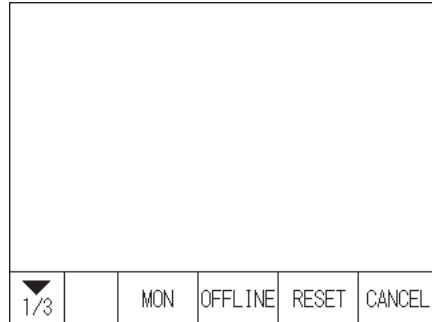

- 3) Next, click on the 2/3 cell to display the following menu.

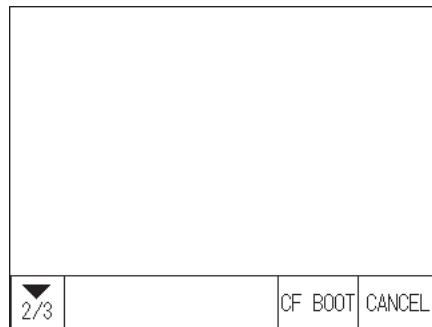

- 4) The IP Address assigned to the GP will appear in the menu bar.



**Note:** The IP Address will not be reflected unless GP was reset or power cord was re-connected. After changing “Ethernet Setup” settings, the GP must then be reset or power cord must be reconnected.

## 4.3 CF Memory Loader Tool

The GP2300/2301 allow you to use the CF Memory Loader Tool in the CF Card to set up the GP, transfer screen data, and upload GP internal data to its internal CF Card.



- Note:** • You need to transfer the CF Memory Loader Tool to the CF Card prior to using the CF Memory Loader Tool.

▼ **Reference** ▲ *GP-PRO/PBIII for Windows Operation Manual*

- When using GP-2300 Series units, the CF Memory Loader Tool and Backup Data require more than 7MB of CF Card memory, and require more than 5MB of CF Card memory when using GP-2301 Series units. When using Digital's CF Card "GP077-CF10 (8MB)", if the combination of this data and your GP's filing data and image data collectively require more than 8MB, the memory space of the CF Card will run out.

### ■ Starting the CF Memory Loader Tool

There are two methods for starting this program via the CF Card.

#### 1. Menu Bar: Using the GP's [CF BOOT] menu

Insert the CF Card with the CF Memory Loader Tool saved into the GP and touch the menu screen's [CF BOOT] selection. The GP will be reset, and after it restarts, the CF card's "CF Memory Loader Tool" will start.

▼ **Reference** ▲ *For how to display the Menu bar, refer to 6.4.3 Set Up Touch Panel*

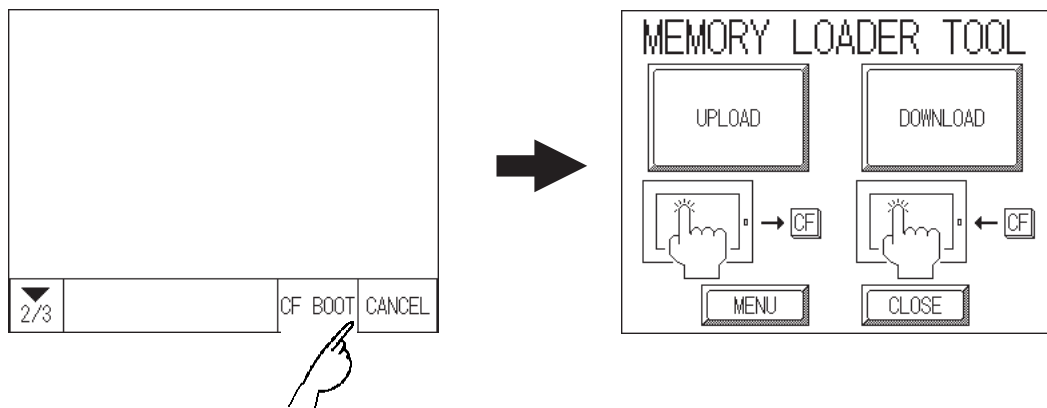

#### 2. GP Dip Switches: Forced Start via GP Dip Switches

You can also use the Dip Switches on the rear of the GP, next to the CF Card Slot. If you turn ON Dip Switch No.1 (lower it) and then connect the GP unit's power cord, the "CF Memory Loader Tool" will automatically start.

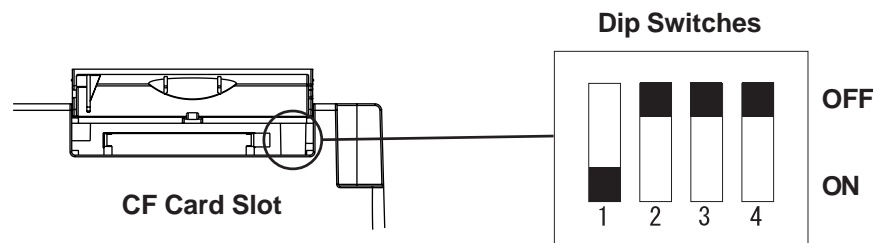

- Note:** When you finish using the CF Memory Loader Tool, be sure to turn this dip switch OFF.

## Chapter 4 - Data Transfer

### 4.3.1 Data Upload and Download

When the Memory Loader Tool program starts, the following screen will appear.

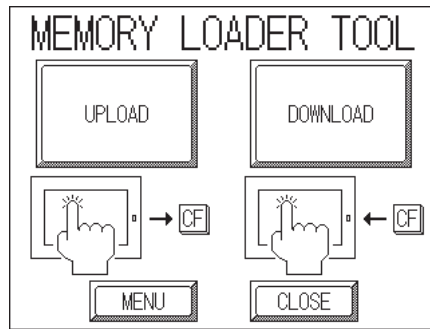

#### ■ UPLOAD (From GP to CF Card)

This feature is for saving all GP internal data (i.e. system program, communication protocol, expansion program, screen data and Backup SRAM data) in the CF Card as backup data.

To start data upload, enter the password you designated in the GP screen creation software's "Transfer" screen, and then touch the "START" key. If you have not designated a password however, simply touch the "START" key.

**Reference** For more information about Passwords, Chapter 6.3.1, "System Setup" and Chapter 5.3, "Initialization"



**When UPLOAD is performed, the CF Card's current Backup Data will be completely overwritten.**

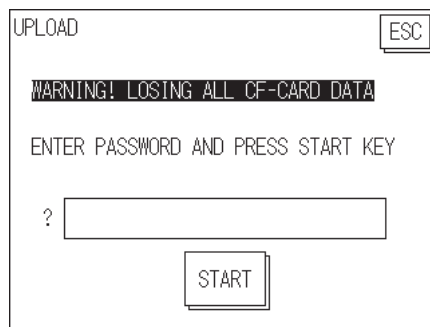

#### ■ DOWNLOAD (From CF Card to GP)

This feature is used for writing CF Card backup data to the GP's Internal SRAM Memory.

To start data download, enter the password you designated in the GP screen creation software's "Transfer" screen, and touch the "START" key. If you have not designated a password, simply touch the "START" key.



**When DOWNLOAD is performed, the GP's Internal Memory data (i.e. system program, communication protocol, expansion program, screen data and Backup SRAM data) will be completely overwritten.**



# Chapter

## 5 OFFLINE Mode

1. Entering OFFLINE Mode
2. OFFLINE Mode Main Menu
3. Initialization
4. Self-Diagnosis

OFFLINE Mode provides access to the Initialize, Self-Diagnosis, and other features built into the GP. Before you can use any of these features, however, you will need to change the GP to OFFLINE mode.



**OFFLINE mode is unavailable in a completely new GP until the necessary GP system data has been transferred from your PC's screen editor software. To do this, be sure the GP's power cord is plugged.**

**Reference** For information about transferring data to the GP, refer to **Chapter 4 "Data Transfer"**, or the **GP-PRO/PBIII for Windows Operation Manual** (included in the screen creation software)

## 5.1 Entering OFFLINE Mode

To INITIALIZE your GP or perform SELF-DIAGNOSIS, you must first switch the GP to OFFLINE mode. There are two ways to enter OFFLINE mode. First, is immediately after plugging in the GP's power cord, and second, by using the Forced Reset feature.

### 5.1.1 After Plugging in the Power Cord

Touch the upper left-hand corner of the GP screen within 10 seconds of plugging in the GP's power cord and the GP will change to OFFLINE mode.

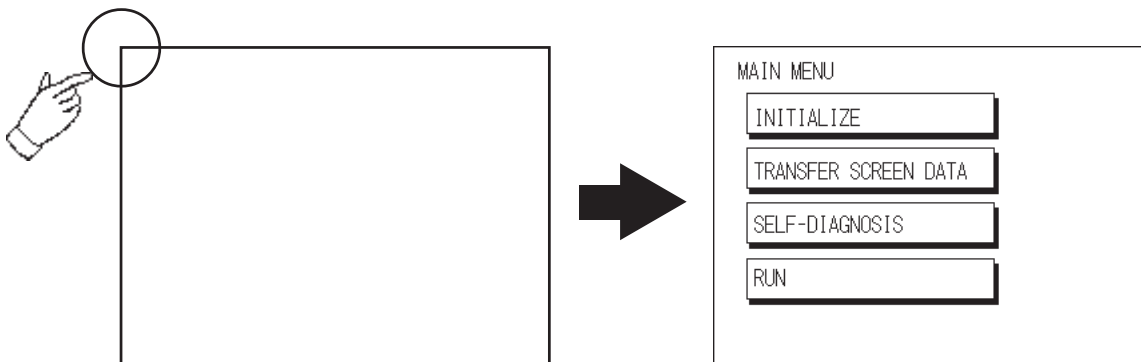

## Chapter 5 - OFFLINE Mode

### 5.1.2 From the Menu Bar

From the GP unit's Menu Bar, touch the OFFLINE square and the OFFLINE mode Main Menu will appear.

**Reference** For instructions on how to call up the Menu Bar, refer to 6.4.3 "Set Up Touch Panel"

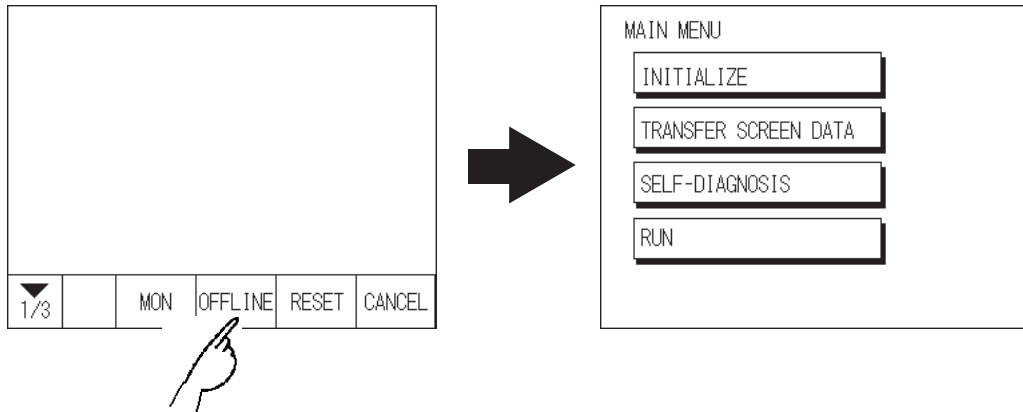

**Note:** If your GP unit has the Device Monitor feature, the "Monitor" square will also appear.

**Reference** GP-PRO/PBIII for Windows Device/PLC Connection Manual (included with the screen creation software), Appendix 3 - Device Monitor

If a Password has been entered in the INITIALIZE/ SET UP SYSTEM area, before entering the OFFLINE mode, the following screen appears.

Here, enter the password, then touch *Set* to enter OFFLINE mode.

**Reference** For more information about Passwords, refer to Chapter 6.3.1, "System Setup" and Chapter 5.3, "Initialization"

The screenshot shows a screen titled 'ENTER PASSWORD'. On the left side, there is a question mark '?' followed by a rectangular input field. In the top right corner, there are two buttons labeled 'SET' and 'ESC'.

## 5.2 OFFLINE Mode Main Menu

---

Each menu item shown below has different settings that must be set to match the corresponding PLC in order for the GP to communicate properly.

Entering OFFLINE mode calls up the following screen.

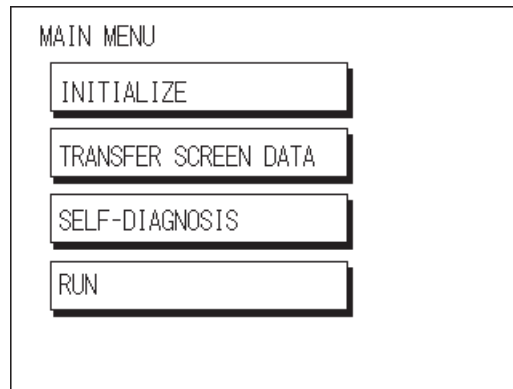

Select the desired menu item by touching the corresponding screen item bar. Each Main Menu item is used as follows.

### ■ INITIALIZE

The setup items contained in this menu are used to control the GP unit.

### ■ SCREEN DATA TRANSFER

Select to transfer screen data to and from the screen editing software.

### ■ SELF-DIAGNOSIS

Checks to see if there are any problems with the GP System or Interface (I/F).

### ■ RUN

Starts GP operation.

### ▼ Reference ▲

*For more information about INITIALIZE, refer to **Chapter 6**.*

*For more information about TRANSFER SCREEN DATA, refer to **Chapter 4** or **GP-PRO/PBIII for Windows Operation Manual** (included with the screen creation software).*

*For more information about SELF-DIAGNOSIS and RUN, refer to **Chapter 7**.*



## 5.3 Initialization

### ■ Selecting A Menu

Touch the menu item, or input field to select it.

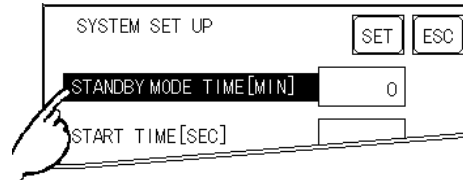
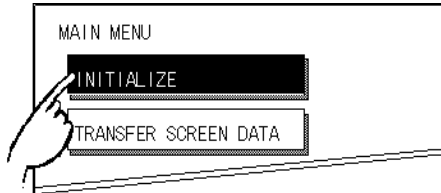

### ■ Entering Numbers

After selecting an input field by touching it, use the numeric touch keys located at the bottom of the screen to enter numeric values. After inputting each value, touch the [SET] key to define the value.

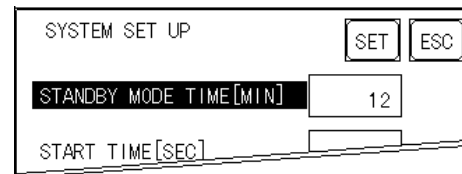
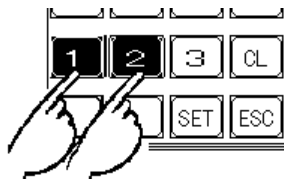

### ■ Selecting Setup Conditions

After selecting a menu item and entering that area, touch the option you would like to setup. The selected item becomes highlighted. In this example, the TOUCH BUZZER SOUND has been set Off.

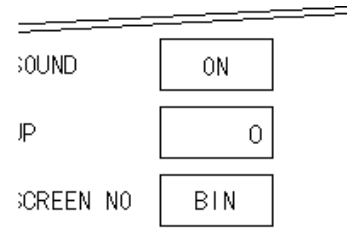
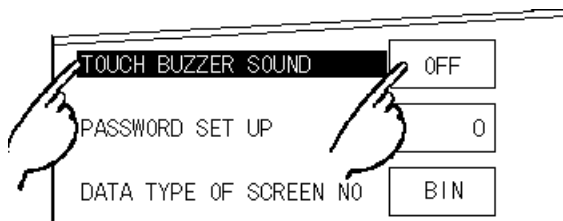

### ■ After All Setting Data is Entered

Touch the top-right [SET] button.

If you wish to exit the screen without saving the changes, touch the CANCEL button.

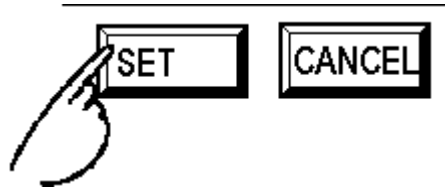

- Press the [SET] key to write the Setup conditions onto the Internal FEPRM, which may take some time, causing a delay in returning to the previous screen. Therefore, do not touch the screen until the previous menu display returns.
- Press the [SET] key to *write* the Setup conditions onto the Internal FEPRM, and Press the [CANCEL] key to *not write* the Setup conditions onto the Internal FEPRM and return to the previous menu.

### ■ Return To Previous Screen

Touch the title of the screen you would like to return to.

E.g. To return to the MAIN MENU from the SYS.ENVIRONMENT screen, simply touch the MAIN MENU title.

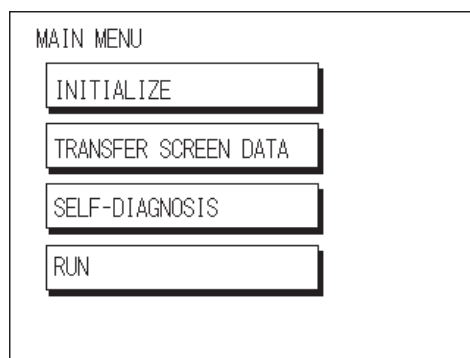
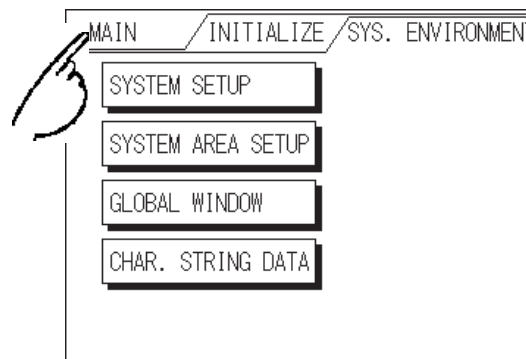

## 5.4 Self-Diagnosis

---

### ■ Selecting a Sub-Display

Touch the desired the menu item and that sub-display will appear.

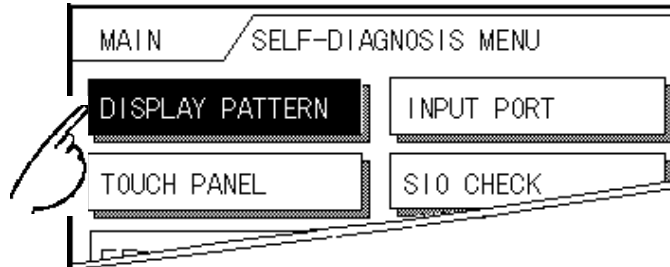

### ■ [SET], [ESC] Keys

After selecting the Self Diagnosis item, the [SET], and [ESC] keys may appear at different times at the top of the screen.

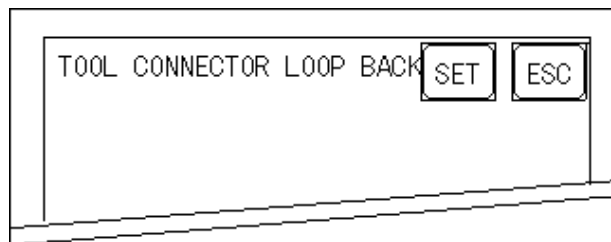

#### ◆ [SET] Key

When this key is pressed, your selected Self-Diagnosis test begins.

#### ◆ [ESC] Key

When this key is pressed, the selected Self-Diagnosis test is cancelled, and you are returned to the SELF-DIAGNOSIS menu.

■ **After Check—To Return To SELF-DIAGNOSIS MENU**

When OK displays,

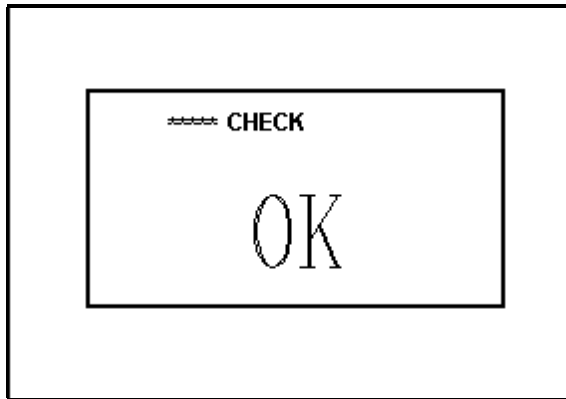

Pressing once anywhere on the display screen returns you to the SELF-DIAGNOSIS MENU.

When an Error Message displays

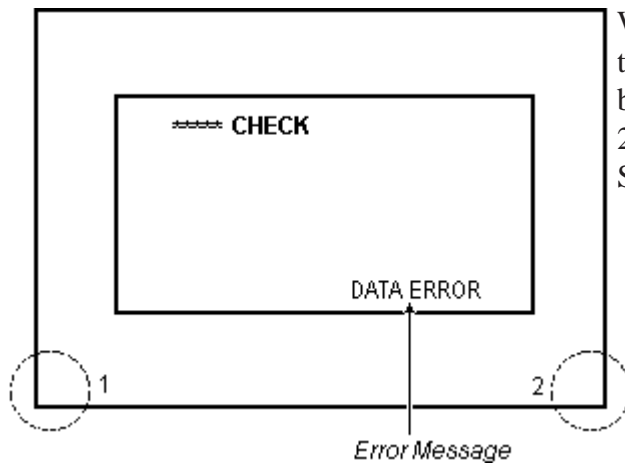

When an error message appears on the display screen, touch the bottom two corners of the panel (1, 2) to return to the SELF-DIAGNOSIS MENU.

■ **Return To Main Menu**

Touch the MAIN Key in the top right corner of the SELF-DIAGNOSIS menu to return to the MAIN MENU.

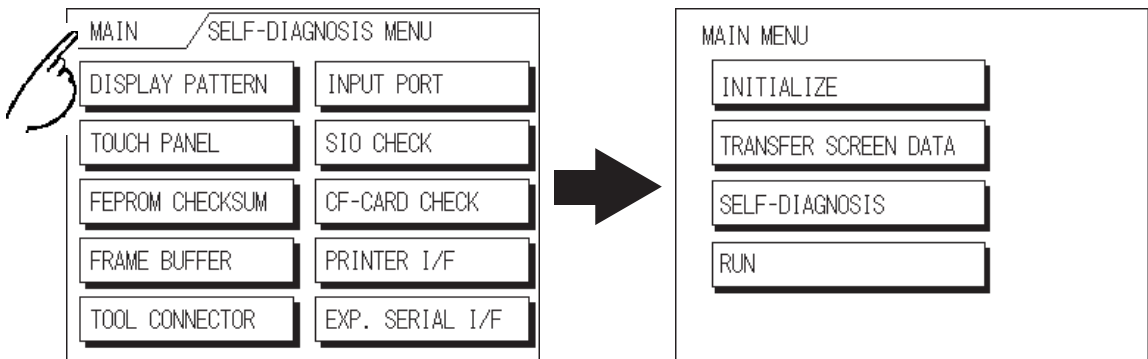

# *Memo*

# Chapter

# 6 Initializing the GP

1. Initialization Screen
2. Initialization Items
3. System Environment Setup
4. Set Up I/O
5. PLC Setup
6. Initialize Internal Memory
7. Set Up Time
8. Set Up Screen
9. Font Setting

## 6.1 Initialization Screen

---

Occasionally, you may want to change your GP's general operation settings. The settings used for this are found in the INITIALIZE option in the GP OFFLINE mode's MAIN MENU.

This chapter explains each of the OFFLINE mode's INITIALIZE items. However, there are 2 types of INITIALIZE settings, those for the **1:1** connection and those for the **n:1** (multi-link) connection\*<sup>1</sup>.

The **n:1** mark appears on original menu items related to n:1 multi-link connection items. If there is no mark, the menu item is common to both 1:1 and n:1 connections.

**1:1** A single (1) GP is connected with a single (1) PLC.

**n:1** Multiple GPs are connected with a single PLC. The GPs successively pass a *PLC Access Token* (exclusive PLC interaction key) among themselves to designate which unit can communicate with the PLC.

**If you transfer the GP's system file data to the GP via your screen design software\*<sup>2</sup>, the GP operates using that data. If the GP System file has been correctly setup and transferred, the setting of INITIALIZE items become unnecessary.**

**▼Reference▲** *For more information about GP System files, refer to "GP-PRO/PB III for Windows Operation Manual" (included with screen creation software)*

---

\*<sup>1</sup> PLC's that support the n:1 (multi-link) connection are limited.

**▼Reference▲** *"GP-PRO/PB III for Windows Device/PLC Connection Manual" (included with the screen creation software)*

\*<sup>2</sup> Refer to GP screen creation software's "SYSTEM SETTINGS" area.

---

## 6.2 Initialization Items

This chapter explains the contents of the Initialize setup items listed below. For information about screen operations and numeric input.

**Reference** Chapter 5, "OFFLINE Mode"

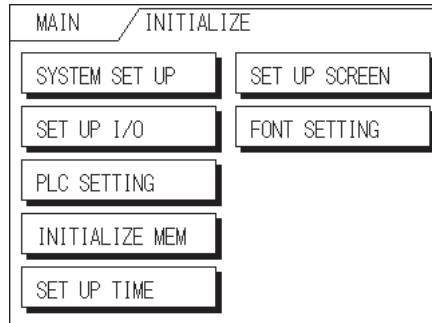

The INITIALIZE menu includes the following items.

### SYSTEM ENVIRONMENT SETUP

- SYSTEM SETUP
- SYSTEM AREA SETUP
- GLOBAL WINDOW
- CHAR. STRING DATA

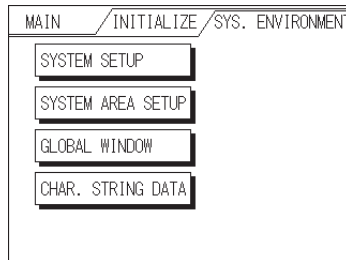

### INITIALIZE MEMORY

- INITIALIZE MEMORY
- INITIALIZE CF-CARD
- CSV DATA INDEX

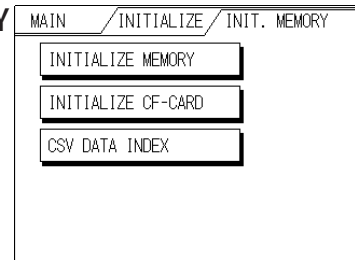

### SET UP I/O

- SET UP SIO
- COMM. SETUP
- SET UP I/O
- DISPLAY SETUP
- PRINTER SETUP (GP-2300 Series unit only)
- EXP. SERIAL SETUP
- EXP. SERIAL ENVI. (GP-2300 Series unit only)
- SET UP CAPTURE OP.
- FUNCTION SETUP
- COM. PORT SET UP

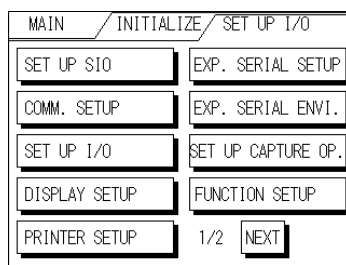

### SET UP TIME

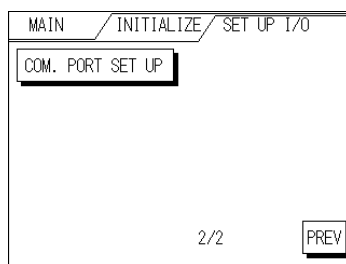
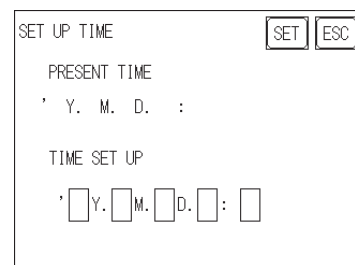

### SET UP SCREEN

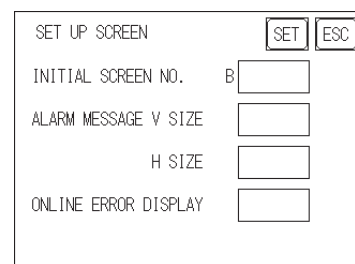

### PLC SETUP<sup>1</sup>

- PLC SETUP
- EXTENDED SETUP
- PLC SETUP

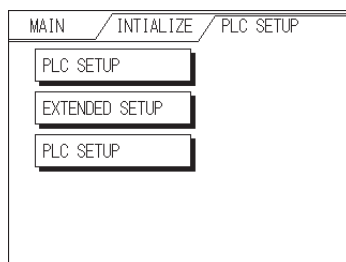

### FONT SETTING

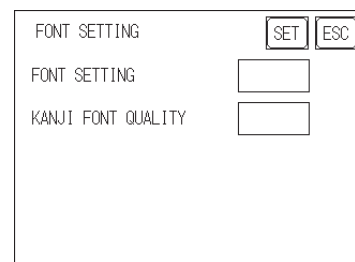

*\*1 Note that, depending on the Device/PLC type selected, the screens that appear in your GP's screen editor software will vary.*

## 6.3 System Environment Setup

These settings allow you to adjust the GP's operation environment. SYSTEM ENVIRONMENT SETUP includes the SYSTEM SETUP, SYSTEM DATA AREA, GLOBAL WINDOW SETUP, and CHARACTER STRING DATA SETUP screens.

### 6.3.1 System Setup

SYSTEM SET UP		SET	ESC
STANDBY MODE TIME[MIN]	<input type="text" value="0"/>		
START TIME[SEC]	<input type="text" value="0"/>		
TOUCH BUZZER SOUND	<input type="text" value="ON"/>		
PASSWORD SET UP	<input type="text" value="0"/>		
DATA TYPE OF SCREEN NO	<input type="text" value="B I N"/>		

#### ■ STAND-BY MODE TIME [MIN]

To extend the life of the GP's backlight, the GP is equipped with a screen saver function that automatically turns the unit's backlight(s) OFF when no operations have occurred for a designated period of time. A "0" entered in this field causes a normal display, i.e. the screen is cleared after the GP's standard default time elapses.

When SYSTEM DATA AREA's SCREEN DISPLAY OFF\*1 data is 0000h, and the following operations are *not* performed on the screen for the User's designated period of time, the GP's current display is turned OFF. ( **Reference** "GP-PRO/PBIII for Windows Device/PLC Connection Manual" - included with the screen creation software)

- Change Screen
- Alarm Messages (scrolling display)
- Error Message Display (Except for 2Way Error)
- Menu Bar (for forced reset) display
- Touch Screen
- Japanese (FEP) System window

#### ■ START TIME [SEC]

This setup determines the start-up time of the GP. Use this setup to adjust the power up sequence so that the GP starts up after the PLC.

#### ■ TOUCH BUZZER SOUND

Setup whether or not the GP beeps when pressed.

#### ■ PASSWORD SETUP

The password setting is used when changing to the Initialize Memory or Initialize (OFFLINE mode) Screens. The password (*from 0 to 9999*) ensures protection of the GP settings, since the use of OFFLINE mode is controlled. If you do not wish to use this feature, enter the default value, 0.

---

\*1 When using the Direct Access or the Memory Link formats, the object address becomes +9 or +12, respectively. (Only when all items are set within the System Data Area.) **Reference** "GP-PRO/PBIII for Windows Device/PLC Connection Manual" (included with the screen creation software)

---



## Chapter 6 - Initializing the GP

### ■ DATA TYPE OF SCREEN NO.

This setup controls whether BIN or BCD format numbers are used when making screen changes. Screen numbers 1 to 8999 are available for binary format; screen numbers 1 to 1999 are available for BCD format.

### 6.3.2 System Area Setup

SYSTEM AREA SETUP is necessary for the PLC to control its GP-related data, and prepares the PLC internal Data Memory (DM) and Data Register (D)\*<sup>1</sup>. Use this setup to prepare the desired SYSTEM DATA AREA items. SYSTEM DATA AREA is located in the LS area of the GP's internal area.

**When using the Memory Link format, this setting is unnecessary.**

**Reference** *GP-PRO/PB III for Windows Device/PLC Connection Manual* (included with the screen creation software)

Press the item, and when the item is highlighted, it has been selected.

When you press the Confirm key, the SYSTEM AREA CONTENTS screen appears to confirm the selected items.

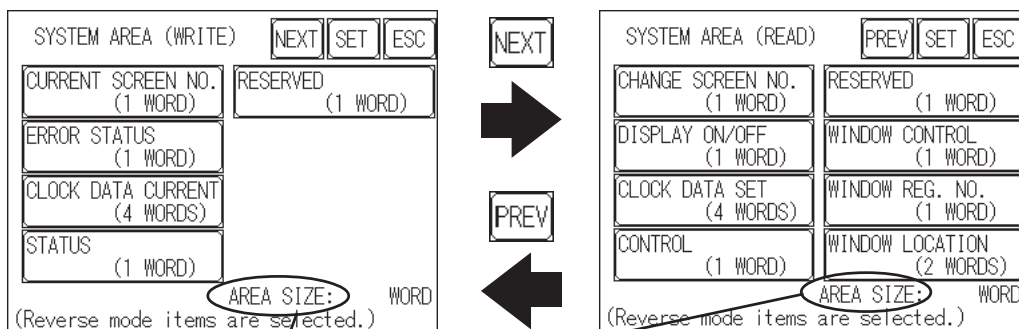

#### ◆ System Area Size

This field displays the total number of words used for the items selected from the SYSTEM AREA SETUP (**Write** and **Read**).



#### Note:

- The setup shown is enabled only when using the Direct Access format.
- The selected System Area items, as displayed on the screen, become the System Data Area.

## Chapter 6 - Initializing the GP

When these five items, "Current Screen Number", "Error Status", "Clock Data (Current)", "Change Screen Number", and "Display ON/Off", have been selected, word addresses are assigned to each item, in order, as shown here.

SYSTEM AREA CONTENTS		SET	ESC
WORD		WORD	
+0	CURRENT SCREEN NO.	+10	
+1	ERROR STATUS	+11	
+2	CLOCK DATA CURRENT	+12	
+3	CLOCK DATA CURRENT	+13	
+4	CLOCK DATA CURRENT	+14	
+5	CLOCK DATA CURRENT	+15	
+6	CHANGE SCREEN NO.	+16	
+7	DISPLAY ON/OFF	+17	
+8		+18	
+9		+19	

The System Data Area selection process follows this formula [System Data Start Address + n]. For example, if the System Area Start Address was D00200, and the *Change Screen Number* option had been selected—if you refer to the System Area Contents screen displayed above—because *Change Screen No's* address is +6, its word address would be  $D00200+6=D00206$ .

**Reference** For information about how to use the System Start Address and Start Address, **6.5.1 Set Up Operation Surroundings**

## Chapter 6 - Initializing the GP

### 6.3.3 Global Window Setup

The GP unit can display three screens at any one time, one *Global Window* and two *Local Windows*. The Global Window is common to all the display screens. The Local Window displays exclusively on the corresponding base screen. The GLOBAL WINDOW SETUP is described here.

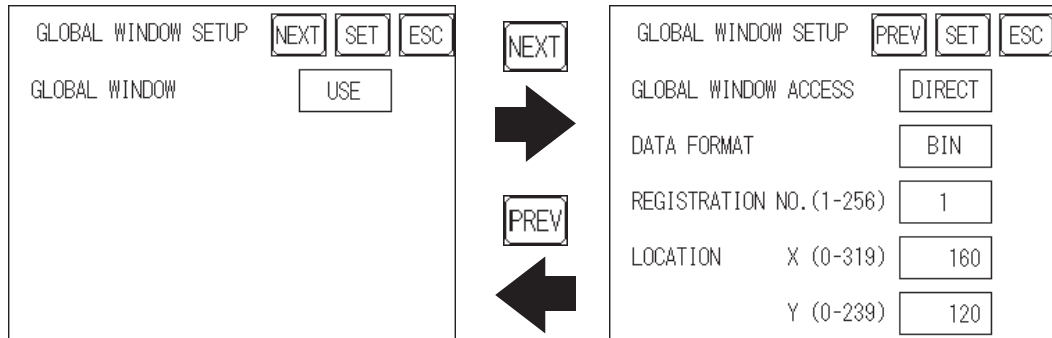

#### ■ GLOBAL WINDOW

There are two options here: **Use** and **Do Not Use**. If you select **Do Not Use**, ignore the items described below. Selecting **Use** enables these options.

#### ■ GLOBAL WINDOW ACCESS

Use this feature to designate whether a value used is **DIRECT** or **INDIRECT**, i.e. the **REGISTRATION NO.** and the **LOCATION** values.

When set as **Direct**, the **REGISTRATION NO.** and **LOCATION** selections are fixed to the values entered here.

When set to **Indirect**, the **WINDOW REG. NO.**'s word address, as prepared in the **System Area**, is a variable. This means it can have the **REGISTRATION NO.** *written* to it and, as a result, multiple window screens can be used as **Global windows**. You can use this method to adjust the **Global window** position by writing the **X,Y** coordinates to the **SYSTEM AREA**'s **LOCATION** word addresses.

#### ■ DATA FORMAT

Setup whether the **REGISTRATION NO.** and the **LOCATION** values are **BIN** or **BCD** values. This field is related only to indirect values.

#### ■ REGISTRATION NO. (1-256)

Enter the **Window Screen Number** used by the **Global Window**. This field is enabled only when **GLOBAL WINDOW ACCESS** is set to **direct**.



**The GP unit's screen editor software allows you to set a window number from 1 to 2000. If you wish to use a number that is 257 or higher, be sure to use the GP unit's screen editor software to enter this value.**

#### ■ LOCATION

Enter the value used for the (**Global WINDOW**) **LOCATION**. This field is enabled only when **GLOBAL WINDOW ACCESS** is set to **direct**.

## 6.3.4 Character String Data Setup

Character String Data ordering varies from manufacturer to manufacturer. Setup the Character String Data order here to match the corresponding PLC.

CHARACTER STRING DATA SETUP SET ESC

CHAR. STRING DATA MODE 1  
(1-8)



**Setup the CHARACTER STRING DATA MODE to match the PLC type. Device type and Tag settings are unavailable.**

### ■ CHARACTER STRING DATA MODE (1-8)

Find the data storage order for your PLC in the table, down below, and setup the CHARACTER STRING DATA MODE.

- (I) Data Device Storage Order
- (II) Internal Word Byte LH/HL Storage Order
- (III) Internal Double-word Word LH/HL Storage Order

### ◆ Character String Data Mode List

(I) Data Device Storage Order	(II) Internal Word, Byte LH/HL Storage Order	(III) Double-word Internal Word LH/HL Storage Order	Character String Data Mode
Storage from Initial data	LH order	LH order	4
		HL order	2
	HL order	LH order	5
		HL order	1
Storage from End data	LH order	LH order	6
		HL order	7
	HL order	LH order	8
		HL order	3

# Chapter 6 - Initializing the GP

## I) Data Device Storage Order

E.g. Characters "A B C D E F G H"  
                  └─┘ └─┘ └─┘ └─┘  
                  ① ② ③ ④

• Storage from Start Data

①	D100
②	D101
③	D102
④	D103

• Storage from End Data

④	D100
③	D101
②	D102
①	D103

## II) Word Byte LH/HL Order

E.g. Characters "A B C D"  
                  ①②③④

• 16 bit Device LH Order

②	①	D100
④	③	D101

• 16 bit Device HL Order

①	②	D100
③	④	D101

• 32 bit Device LH Order

②	①	④	③	D100
---	---	---	---	------

• 32 bit Device HL Order

①	②	③	④	D100
---	---	---	---	------

## III) Double-word Word LH/HL Order

E.g. Characters "A B C D E F G H I J"  
 ① ② ③ ④ ⑤

### • 16 bit Device LH Order

②	D100
①	D101
④	D102
③	D103
⑤	D104

### • 16 bit Device HL Order

①	D100
②	D101
③	D102
④	D103
⑤	D104

E.g. Characters "A B C D E F G H I J K L M N O P Q R S T"  
 ① ② ③ ④ ⑤ ⑥ ⑦ ⑧ ⑨ ⑩

### • 32 bit Device LH Order

②	①	D100
④	③	D101
⑥	⑤	D102
⑧	⑦	D103
⑩	⑨	D104

### • 32 bit Device HL Order

①	②	D100
③	④	D101
⑤	⑥	D102
⑦	⑧	D103
⑨	⑩	D104



**Note:** Relationship between K-tag Write Character Value and PLC Device

### • 16 bit Devices

GP stores the character string from the start, as groups of 2, into 1 PLC Device.

When there are nine characters, they are arranged as shown below.

1 2 3 4 5 6 7 8 9 Null  
 └─┘ └─┘ └─┘ └─┘ └─┘



**Note:** When the characters do not divide into 2 evenly, NULL is added at the end.

### • 32 bit Devices

GP stores the character string from the start, as groups of 4, into 1 PLC Device.

When there are nine characters, they are arranged as shown below.

1 2 3 4 5 6 7 8 9 Null  
 └─┘ └─┘ └─┘



**Note:** When the characters do not divide into 4 evenly, NULL is added at the end.

### 6.4 Set Up I/O

---

This section describes the communication setup with the Host (PLC) and the setup for any peripheral equipment. The SET UP I/O menu includes the SET UP SIO, COMMUNICATION SETUP, SETUP I/O, DISPLAY SETUP, PRINTER SETUP, EXPANSION SERIAL SETUP, EXPANSION SERIAL ENVIRONMENT SETUP, SET UP CAPTURE OPERATION, FUNCTION SETUP and COMMUNICATION PORT SET UP menus.

#### 6.4.1 Set Up SIO

---

This menu runs the settings related to PLC communication. Be sure to match the settings listed below with the SIO setup on the PLC host, if not, an error may occur.

**Reference** *GP-PRO/PBIII for Windows Device/PLC Connection Manual* (included with screen creation software)

SET UP SIO	SET	ESC
COMMUNICATION RATE	19200	
DATA LENGTH	7/2	
PARITY	EVEN	
CONTROL	ER-CNTRL	
COMMUNICATION INTERFACE	RS232C	



**Note:** If you have selected "YES" for the [SERIAL I/F CHANGE] on the [COMMUNICATION PORT SETUP] screen, or "Yes" for the [Serial I/F Switch] settings in the [Change Extend SIO Type] command, in the GP Screen Editor's [Project] menu, do not enter all of the settings related to device communication using the Extended SIO Script Protocol here. ([SET UP SIO] screen) These settings are required to set using the [EXPANSION SERIAL COMMUNICATION SETUP] screen.

**Reference** *6.4.6 Expansion Serial Setup*

#### ■ COMMUNICATION RATE

The COMMUNICATION RATE (baud rate) is the data communication speed, measured in bits per second (bps), between the GP and PLC. Match the COMMUNICATION RATE values in both the PLC and GP. Depending on the rate selected, certain PLCs may not be able to be used.

**Reference** *GP-PRO/PBIII for Windows Device/PLC Connection Manual* (included with screen creation software)

#### ■ DATA LENGTH

For data communications, the DATA LENGTH must be set up as 7-bit or 8-bit data, and set up also the STOP BIT as either a 1-bit or 2-bit value.

#### ■ PARITY

Set up whether no parity check, or an odd or even number parity check will take place during communication.

### ■ CONTROL

Data flow CONTROL prevents the overflow of data sent back and forth. Select either X-CNTRL or ER-CONTRL.

### ■ COMMUNICATION INTERFACE

Select one of the following options for the communication format: RS-232C, RS-422 (4 line), or RS-422 (2 line).



**Note:**

- When using an RS422 cable and the Memory Link format, be sure to select the 4-line option.

▼ **Reference** ▲ *GP-PRO/PBIII for Windows Device/PLC Connection Manual* (included with screen creation software)

- If you have selected "YES" for the [SERIAL I/F CHANGE] on the [COMMUNICATION PORT SETUP] screen, or "Yes" for the [Serial I/F Switch] settings in the [Change Extend SIO Type] command, in the GP Screen Editor's [Project] menu, be sure to select RS-232C.



### 6.4.2 Communication Setup

---

COMMUNICATION SETUP	SET	ESC
RECEIVE TIMEOUT (1-127)	10	SEC
RETRY COUNT (0-255)	2	

#### ■ RECEIVE TIMEOUT (1-127)

Sets the value used for the data reception timeout (PLC - GP).

If the cable is not connected, data communication will Timeout in one second, regardless of this setting's value. The default is "10" seconds.



**Note:** If you transfer screens when a PLC communication error has occurred and the error is not yet cleared, and the RECEIVE TIMEOUT value is set to 30 seconds or more, an error message may appear on your personal computer.

#### ■ RETRY COUNT (0-255)

Designates how many times the GP tries to send data to the PLC when a PLC communication error occurs. An Error Message will appear on the GP after the GP tries to send data to the PLC the number of times set by this option. The default is "2".

6.4.3 Set Up Touch Panel

Touch operation and Force Reset setup, and Display Device adjustments are made here. There may be differences on these settings depending of the GP type.

GP-2300L/GP-2301L Setup Screen

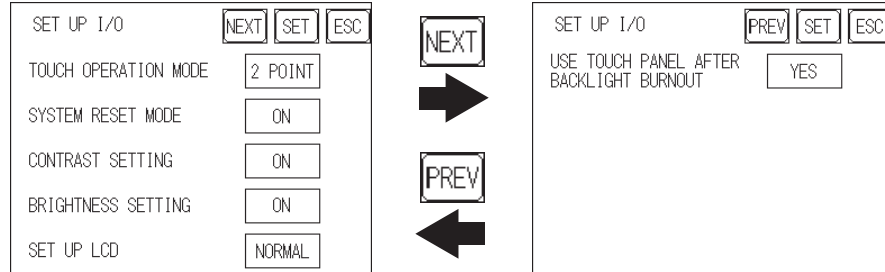

GP-2300S/GP-2300T/GP-2301S/GP-2301T Setup Screen

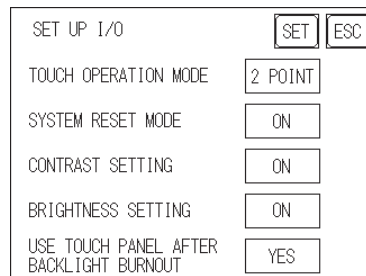

■ TOUCH OPERATION MODE

Designates either One Point, Two Point or No Slide. When No Slide is selected, dragging one's finger across the touch screen will elicit no screen response, and only individually selected points will register.

■ SYSTEM RESET MODE

Designates whether to display or hide the Menu Bar. The Menu Bar can be displayed using the following procedure when "ON" is selected.

◆ Steps to run SYSTEM RESET

While pressing down on the bottom right corner (1) of the screen, press the upper right corner (2). At the same time, press the bottom left corner (3) to enter the FORCE RESET Operation. To activate Reset, press the **RESET** button, to transfer to OFFLINE Mode, press **OFFLINE**.

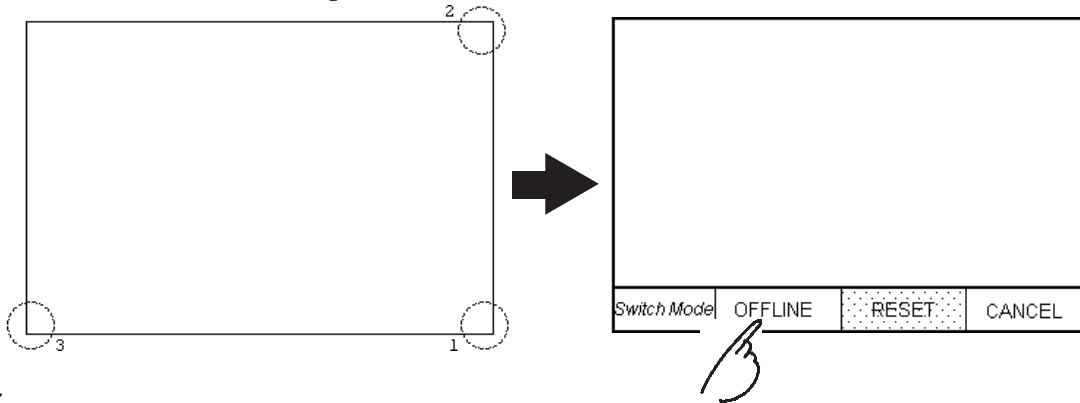

**FORCE RESET can occur during either RUN mode or OFFLINE mode.**



- The SYSTEM RESET mode cannot be entered while the GP is starting up.
- Entering SYSTEM RESET is possible even when RUN operations (PLC ↔ GP communication) are not being performed.

## Chapter 6 - Initializing the GP

### ■ CONTRAST ADJUSTMENT

When this option is set ON, CONTRAST ADJUSTMENTS can be made through touch input. (The GP-2300T/GP-2301T unit is not equipped with CONTRAST ADJUSTMENT feature.)



**Be sure to press the GP corners in the order shown. If only corner (2) is pressed OFFLINE mode will start.**

While pressing the upper right hand corner (1) of the screen, press the upper left corner (2) to enter CONTRAST ADJUSTMENT mode. Press the desired setting and the screen's contrast will change accordingly.

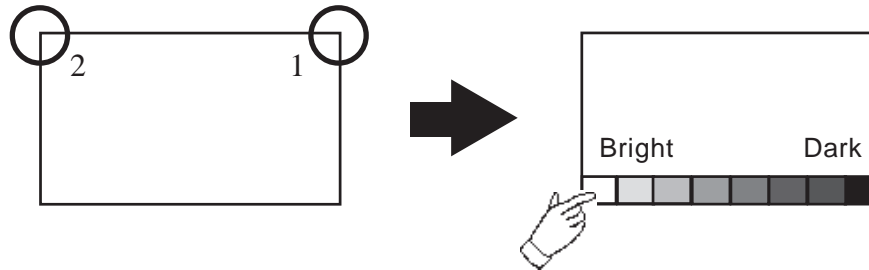

- To end CONTRAST ADJUSTMENT mode, touch anywhere on the screen, except the bottom section.
- CONTRAST ADJUSTMENT mode cannot be entered while waiting for GP to start up.
- CONTRAST ADJUSTMENTS can be made even in the middle of RUN mode (PLC<-->GP communication).
- Regardless of a normal and reversed display, the left side of the contrast adjustment bar, displayed at the bottom area of the screen, is always "Bright".

### ■ BRIGHTNESS ADJUSTMENT

When set to ON, BRIGHTNESS ADJUSTMENT can be performed via touch input. Press the bottom left corner (2) of the screen while holding down the bottom right corner (1) to enter BRIGHTNESS ADJUSTMENT mode. Touch the left-side of the bar to brighten the display; touch the right-side of the bar to dim the display. This unit has four levels of adjustment.

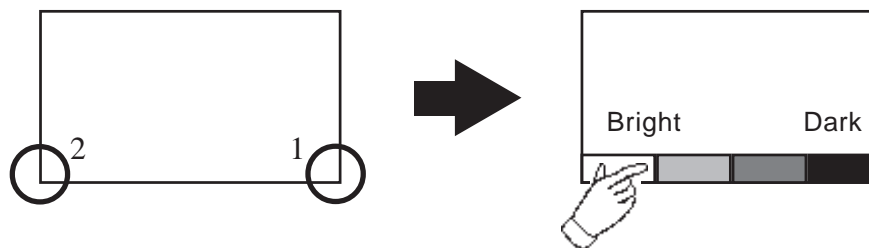

- With the GP units, reducing the display brightness may cause flicker. Adjust it by changing the display device settings.

#### ▼ Reference ▲ 6.4.4 DISPLAY DEVICE SETTINGS

- To end BRIGHTNESS ADJUSTMENT mode, touch anywhere on the screen, except the bottom section.
- BRIGHTNESS ADJUSTMENT mode cannot be entered while the GP is starting up.
- BRIGHTNESS ADJUSTMENT can be used even during RUN mode (PLC<-->GP communication).
- Regardless of a normal and reversed display, the left side of the contrast adjustment bar, displayed at the bottom area of the screen, is always "Bright".

### ■ SET UP LCD (GP-2300L/GP-2301L only)

To reverse the screen display colors, touch SET UP LCD on the SET UP I/O screen to change the setting from "NORMAL" to "REVERSE", and then touch the "SET" key.

The display color will be reversed and the previous screen will reappear.

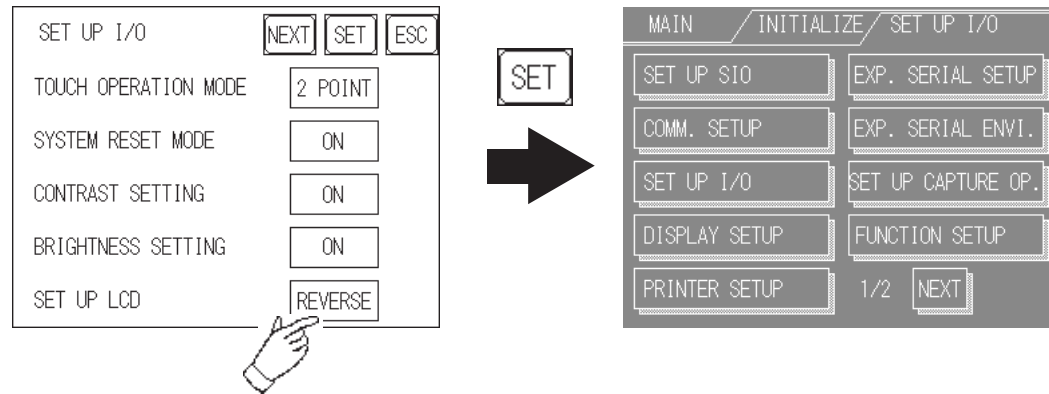

### ■ USE TOUCH PANEL AFTER BACKLIGHT BURNOUT

This option designates whether touch-operation is disabled or not when the backlight burns out.

If this selection is set to [OFF], touch-operation will be disabled when the backlight burns out, which prevents the GP from sending input signals to the PLC.



**Note:**

- When the backlight burns out, the Status LED's orange light turns ON, and the System Data Area's "Status" bit 10\*1 will turn ON.
- If the [SYSTEM RESET] option is set to [ON], only "System Reset" can still be performed by touch-operation in case of backlight burnout.
- If the backlight burns out when the GP is OFFLINE, touch-panel operation is enabled, regardless of these settings.



**Normally, the GP unit detects a backlight burnout by monitoring the backlight's current flow, however, the GP may fail to detect this condition, depending on the type of backlight problem, and also the GP may detect the condition before the backlight burns out.**

---

\*1 Bit +6 (when using the Direct Access method), and bit +11 (when using the Memory Link method), will turn ON.

▼ **Reference** ▼ *GP-PRO/PBIII for Windows Device/PLC Connection Manual* (included with screen creation software)

---

## Chapter 6 - Initializing the GP

### 6.4.4 Display Setup

---

The GPs screen may flicker, or there may be shadows appearing on extended display lines on the LCD surface. In the case where the GPs ambient temperature becomes high, and its current brightness level is set to low, this effect may be more pronounced. This phenomenon is however, a common attribute of LCDs and is not a defect. To solve this, use this setting for adjusting the GPs brightness. (The GP-2300T/GP-2301T unit is not equipped with DISPLAY SETUP feature.)

- STN color LCD (GP-2300S/GP-2301S)

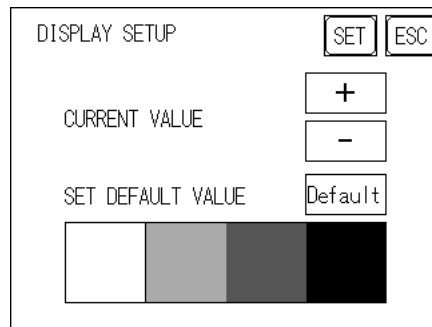

- Monochrome LCD (GP-2300L/GP-2301L)

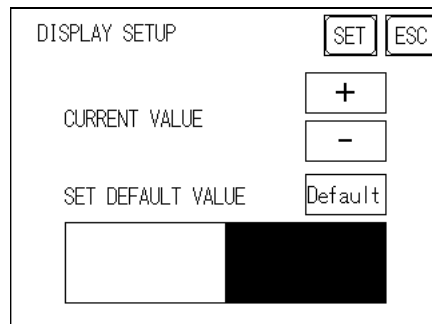

<When using 8 levels of gray>

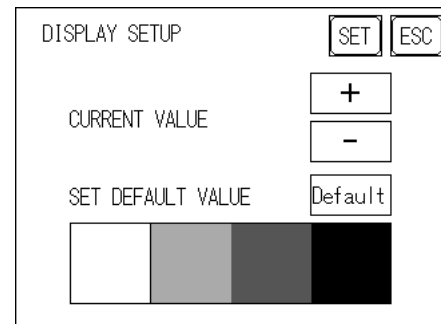

<When using Black and White>

#### ■ CURRENT VALUE

To solve the above problem, touch "+" or "-" to adjust the brightness. You can check the actual brightness in the preview field at the bottom of the screen. From the default value of "0" there are 18 "+" levels and 2 "-" levels available.

#### ■ SET DEFAULT VALUE

If you touch "Default", the setting returns to "0".

## 6.4.5 Set Up Printer

This setting is used to designate the type of printer that will be connected to the GP.  
(Only GP-2300 Series units.)



GP-2300L Setup Screen

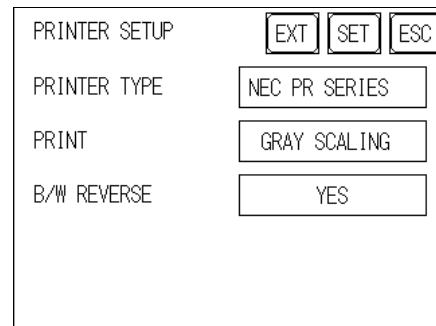

GP-2300S/2300T Setup Screen

### ■ PRINTER TYPE

Printers that are compatible with NECPC-PR201/PL, EPSON ESC/P24-J84(C), HP Laser Jet PCL 4 commands, EPSON PM/Stylus (6-color ink) and EPSON Stylus (4-color ink) printers can be used.



**Note:**

- There is no difference in the quality and printing speed between EPSON ESC/P (High Speed) and EPSON ESC/P (High Quality) when printing out hard copy of screen images from GP-2300S and GP-2300T.

- Using EPSON PM/Stylus (6-color ink), EPSON Stylus (4-color ink) printers, GPPRO/PBIII for Windows Ver.6.2 or later is required. For details,

▶ **Reference** ■ EPSON PM Series / EPSON Stylus Series

### ■ PRINT

Two selections [GREY SCALING] and [COLOR] are available. If you select [GREY SCALING], the same pattern will be applied to:

• Blue and Green • Light blue and Red • Purple and Yellow

GP-2300S and GP-2300T Only.



**Note:**

- Since HP LaserJet Series printers do not support color printing, be sure to designate [GREY SCALING].

- With the [GREY SCALING] feature, printing patterns are reduced to 5 levels of gray from 256 or 64 colors.

Colors that do not appear in the printout are ones that have been converted to white.

### ■ B/W REVERSE

This setting is used for reversing the background and display color black/white color attributes. When the color is reversed, the background color is printed as black and the character color is printed as white. GP-2300S and GP-2300T Only.

<e.g.> When the background color is black and the display color is white.

When “BLACK/WHITE REVERSE” is selected.



When “BLACK/WHITE REVERSE” is **not** selected.



**Note:**

This setting is enabled only when a screen display is printed. Alarm or Recovery data output is printed always as black, regardless of the setting selected.

## Chapter 6 - Initializing the GP

### ■ EPSON PM Series / EPSON Stylus Series

#### ◆ Restrictions for using EPSON PM / EPSON Stylus Series printers

- When printing using an EPSON PM/Stylus (6-color) or an EPSON Stylus (4-color) printer, GP screen updating (tag processing, etc.) will be slower.
- Since OFFLINE Self-diagnosis (Printer I/F Check) is used only for ASCII code output, it will not produce a correct printout.
- When screen data printout uses levels of shading, printout from these printers will differ from a different type printer (PR201, etc.). This is because colors are recognized based on shading level patterns and not on the density of shading.

#### ◆ Extension Settings

When specifying EPSON PM/Stylus (6-color) or EPSON Stylus (4-color) as "PRINTER TYPE", "PRINT MAGNIFY" feature for screen data printout can be specified in the [SET UP PRINTER (EXT-SET)] screen.

Specify either EPSON PM/Stylus (6-color) or EPSON Stylus (4-color) as "PRINTER TYPE", and touch the **[EXT]** key.

[SET UP PRINTER (EXT-SET)] screen will appear. Touch the desired magnification.

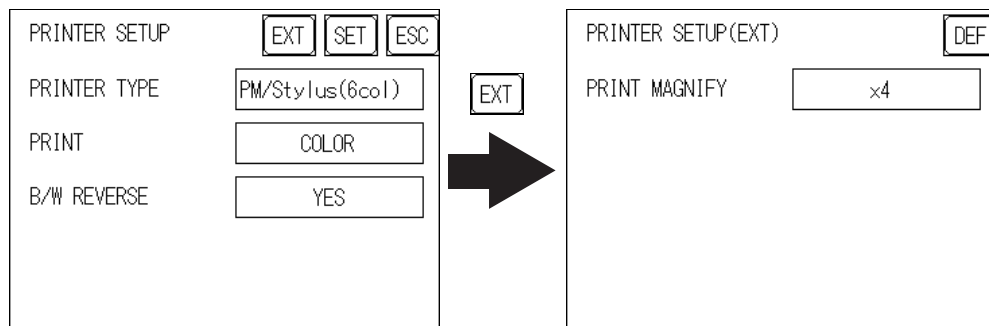

When specifying "PRINTER TYPE", except for EPSON PM/Stylus (6-color), EPSON Stylus (4-color) printers, touching the **[EXT]** key causes the following screen to appear.

Touch the **[ESC]** key, and the [SET UP PRINTER] screen will reappear.

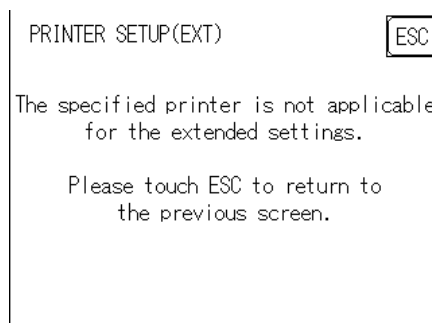

### 6.4.6 Expansion Serial Setup

The following explains the setup for communicating with a device connected to the Expansion Serial Interface. This setup screen will not display unless the communication protocol for the Expansion Serial Interface (specified with "SET UP EXPANSION SIO" of the GP screen creation software package) is transferred to the GP.



**If you have selected "YES" for the [SERIAL I/F CHANGE] on the [COMMUNICATION PORT SETUP] screen, or "Yes" for the [Serial I/F Switch] settings [Change Extend SIO Type] command, in the GP Screen Editor' [Project] menu, enter all of the settings related to device communication using the Extended SIO Script Protocol here, [EXPANSION SERIAL COMMUNICATION SETUP] screen.**

EXP.SERIAL SETUP	SET	ESC
COMMUNICATION RATE	9600	
DATA LENGTH	8/1	
PARITY	OFF	
RI/VCC (COM2)	RI	
COMMUNICATION FORMAT	RS232C	

#### ■ COMMUNICATION RATE

The COMMUNICATION RATE refers to the data communication speed, measured in bits per second (bps), between the GP and the device connected to the Expansion Serial Interface.

The supported communication rates vary depending on the connected device. Refer to the instruction manual of the connected device for more information. The initial setting varies depending on the communication protocol for the Expansion Serial Interface being transferred.

#### ■ DATA LENGTH

Set the DATA LENGTH to 7-bit or 8-bit data, and set up also the STOP BIT as either a 1-bit or 2-bit value.

#### ■ PARITY

Set the parity to no parity (OFF), or an ODD or EVEN parity check.

#### ■ RI/VCC

This setting designates if the Serial Interface's #9 pin is used for RI (Input) or for VCC (Output).

VCC is only enabled in RUN mode, and if the mode is changed from RUN to OFFLINE, this will change to RI. When an Expansion Serial protocol is not used, this setting is fixed at RI.



**There is a danger that the SIO circuit can be damaged if the VCC setting is used and the Expansion Serial Interface's check tool is connected.**

**Reference** 7.2.2 Self-Diagnosis - Details

#### ■ COMMUNICATION FORMAT

Select one of the following options for the communication format: RS-232C, RS-422 (4 line), or RS-422 (2 line).



## Chapter 6 - Initializing the GP

### 6.4.7 Expansion Serial Environment Setup

---

The following setting varies depending on the communication protocol for the Expansion Serial Interface being transferred.

This section explains the case where “SERIAL CODE READER(LS)” is transferred.

Use this setting when a serial code reader is connected to the Expansion Serial Interface to read serial code data. (Only GP-2300 Series units.)

EXP.SERIAL ENV SETUP	SET	ESC
SCANNING MODE	DEFAULT	

#### ■ SCANNING MODE

Select the SCANNING MODE according to the scanner settings.

The communication format for each mode is shown below:

- Standard

Code data	Terminator (CR)
-----------	-----------------

- QR code scanner manufactured by Denso

Header (STX)	Code mark (7 bytes)	No. of digits (4 bytes)	Code data	Terminator (CR)	BCC (7 bytes)
--------------	------------------------	----------------------------	-----------	--------------------	------------------

- Code scanner manufactured by Tohken

Header (STX)	Code data	Terminator (CR + LF)
--------------	-----------	----------------------

### 6.4.8 Set Up Capture Operation

---

Save the captured image of the GP's screen as a JPEG file in the CF Card.

SET UP CAPTURE OPERATION	<input type="button" value="SET"/>	<input type="button" value="ESC"/>
QUALITY(1-100)	<input type="text" value="80"/>	
B/W REVERSE	<input type="text" value="YES"/>	

#### ■ QUALITY (1-100)

Sets the captured JPEG image quality. When the small value is set, the image file size becomes small, but the image quality becomes worse.

#### ■ B/W REVERSE

The white part in the image that is created in the screen creation program is reversed to black, and the black part is reversed to white. The reversed screen is captured and saved.



**Note:** Only black and white are reversed. All other colors remain unchanged.

#### ◆ GP-2300L/GP-2301L (Monochrome LCD)

- When "B/W REVERSE" is "YES"

The displayed part (image data) is saved as black, and the non-displayed part is saved in white.

- When "B/W REVERSE" is "NO"

The displayed part (image data) is saved as white, and the non-displayed part is saved in black.



**Note:** The monochrome LCD's GP saves image data as black in the CF Card, regardless of the GP's reverse display setting.

#### ◆ GP-2300S/GP-2301S/GP-2300T/GP-2301T (STN/TFT Color LCD)

The Color LCD GP captures a B/W reverse image and saves it to the CF Card.

The white part of the image is converted to black, and the black part of the image is converted to white. Only black and white colors are converted.

## Chapter 6 - Initializing the GP

### 6.4.9 FUNCTION SETUP

---

Since the GP-2300/2301 Series units are not equipped with a function key, function setup is not required.

### 6.4.10 COMMUNICATION PORT SETUP

---

This screen allows you to set up the connection environment of the GP's communication port.

COMMUNICATION PORT SET UP	SET	ESC
SERIAL I/F CHANGE	NO	
RI/VCC (COM2)	RI	

#### ■ SERIAL I/F CHANGE

Selecting "YES" designates that the communication used for the Extended SIO Script Protocol starts at the Serial I/F (COM1). Also, the communication used for the device/PLC starts at the Expansion Serial I/F (COM2).

In OFFLINE mode, the SERIAL I/F CHANGE setting is set to "NO".



- After selecting "YES", enter all of the settings related to device communication using the Extended SIO Script Protocol, [EXPANSION SERIAL COMMUNICATION SETUP] screen. Enter all of the settings related to Device/PLC communication, [SETUP SIO] screen.
- To use the "SERIAL I/F CHANGE" feature, the system of GP-PRO/PB III for Windows Ver.6.2 or later is required to be transferred to the GP.

#### ■ RI/VCC (COM2)

This setting designates if the Serial Interface's #9 pin is used for RI or for VCC.

## 6.5 PLC Setup

Set up the GP System Area and the Unit number in this screen. Because 1:1 and n:1 GP connections utilize different settings, confirm your connection's needs before using any settings.



**Note:** • The screens that appear will depend on the PLC type you selected in the screen creation software.

▼ **Reference** ▲ *GP-PRO/PBIII for Windows Device/PLC Connection Manual (included with screen creation software)*

• When the GP-PRO/PBIII for Windows Ver 3.0 "Simulation" feature is used, the OPERATION SURROUNDINGS menu cannot be used.

### 6.5.1 Set Up Operation Surroundings (1:1/n:1)

Enter the PLC System Data Area and the Unit Number settings here. The same options are available for both 1:1 and n:1 (Multi-link) connections.

For an n:1 (Multi-link) Connection, System Data Area settings must be setup for each GP connected to the PLC.

▼ **Reference** ▲ *GP-PRO/PBIII for Windows PLC Connection Manual (included with screen creation software)*

MAIN / INITIALIZE / PLC SETUP MENU	
1:1	n:1
PLC SETUP	
STATION SETUP	
CUSTOMIZE SETUP	

➔

SET UP OPERATION SURROUNDINGS		SET	ESC
SYSTEM AREA START DEV	<input type="text"/>		
START ADR	<input type="text"/>		
UNIT No.	<input type="text" value="0"/>		
SYSTEM AREA READ SIZE	<input type="text" value="0"/>		
RESET GP ON WRITE DATA	<input type="text" value="OFF"/>		

#### ■ STARTING ADDRESS OF SYSTEM DATA AREA

Setup the System Data Area's Start Address. Device addresses that can be allocated will differ depending on the type of PLC used.

▼ **Reference** ▲ *GP-PRO/PBIII for Windows Device/PLC Connection Manual (included with screen creation software)*

#### ■ UNIT NO.

Enter the PLC UNIT number here. Check that it matches the one set up in the PLC.

#### ■ SYSTEM AREA READING AREA SIZE (0-256)

When using a Block Display Trend Graph, setup the Reading Area Size (in word units) to match the Trend Graph's data size. Use this feature when you wish to allocate the Reading Area in the PLC Data Register (D), or Data Memory (DM).



**Note:** If you are not using the Reading Area, leave the 0 default values intact. This will allow you to perform high speed data communication.

#### ■ RESET GP ON DATA WRITE ERROR

Designates the mode which enables you to cancel the error from the error display when the Write error occurs.



## Chapter 6 - Initializing the GP

For example, when these 4 GP units—bit 0, bit 2, bit 3, bit 5—are connected, 002D (h) is written here.

Connection List 

0	0	0	0	0	0	0	0	0	0	0	1	0	1	1	0	1
---	---	---	---	---	---	---	---	---	---	---	---	---	---	---	---	---

 002D (h)



- **Be certain to setup this data before running.**
- **Turn all bits not related to the GP OFF.**

### ◆ Validation List

This area responds to the correspondence from each connected GP. In the Validation List, when the same bit numbers as the Connection List turn ON, the correspondence is accepted. The Station Numbers of the communicating GPs turn their corresponding PLC bit number ON.

Bit 15								Bit 0							
15	14	13	12	11	10	9	8	7	6	5	4	3	2	1	0
unit	unit	unit	unit	unit	unit	unit	unit	unit	unit	unit	unit	unit	unit	unit	unit

If the correspondence between the GP and PLC is correct, the same value as in the Connection List is written to the Validation List.

For example, the value 002D (h) in the Connection List, setup as the 0 bit, 2 bit, 3 bit, and 5 bit, writes to the Validation List.

Connection List 

0	0	0	0	0	0	0	0	0	0	0	1	0	1	1	0	1
---	---	---	---	---	---	---	---	---	---	---	---	---	---	---	---	---

 002D (h)

Validation List 

0	0	0	0	0	0	0	0	0	0	0	1	0	1	1	0	1
---	---	---	---	---	---	---	---	---	---	---	---	---	---	---	---	---

 002D (h)



- **When the Connection List and Validation List do not match, a COMMUNICATION ERROR occurs. Check the setup again.**
- **When changing the connection, first turn all the bits OFF.**

### ■ STATION NO. (0-15)

This is the setup for the GP Station Number mentioned above. The setup range is from 0 to 15, and the only other restriction is the GP STATION NO. must be unique in the system. If STATION NO.'s are repeated, a COMMUNICATION ERROR occurs.



**Note:** The STATION NO. is the number allocated to the particular GP unit. This number is not related to the Link Unit Machine number.

### 6.5.3 Customize Setup (n:1)

The Customize function modifies the n:1 (multi-link) connection's communication method to make it more effective. To run communication efficiently, the user should first determine whether they wish to have Operation or Display priority set for the GP. Based on this, the communication response speed can be upgraded. (However, this also depends on the screen information displayed.)

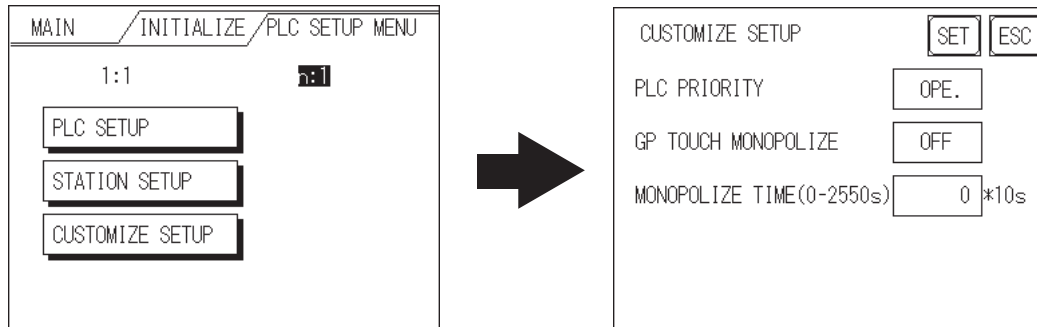

#### ■ PLC PRIORITY

According to how the GP is used, select either Operation priority (OPE.) or Display priority.

- Operation

Setup the GP to this option when using the GP mainly as an operation panel. As a result, the GP will command better touch panel numeric input and switch response times.

Leaving the GP in this mode does not drastically influence the touch panel operation response time of other GPs. The screen display renewal cycle, however, will slow.

- Display

Setup the GP to this option when using the GP mainly as a monitor screen. The GP will command a higher display speed as a result; however, the response time for the touch panel's operations will slow.



- ***In a standard network setup, use the same setup for all connected GP's.***
- ***To increase the display speed, be sure the addresses used are consecutive addresses. When bit addresses are used, use consecutive to the word units.***

- Speed Difference between Display Priority and Operation Priority

When using the Mitsubishi Electric Corp. A3A PLC, with a scan time of 20ms with consecutive addresses (80 words not included in the System Area), the difference in reading speed is as shown in the following graphs.

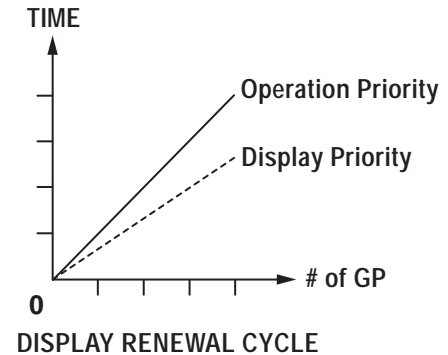
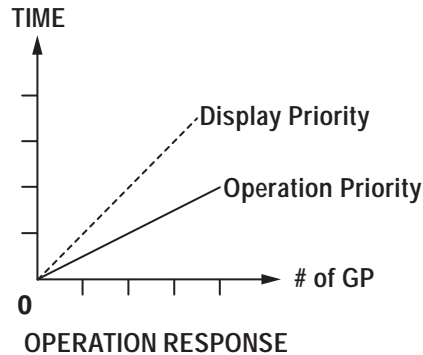

### ■ GP TOUCH MONOPOLIZE

The monopolizing of touch panel use can be set ON or OFF. When you want to use the PLC exclusively with a Momentary operation setup on the touch panel, turn GP TOUCH MONOPOLIZE ON.

When this setup is ON, the touch panel uses the PLC exclusively whenever the momentary operation setup on the panel is pressed. In this way, you can use the inching operation with a momentary switch. When you stop pressing the panel, exclusive use ends.

**Reference** *GP-PRO/PBIII for Windows Device/PLC Connection Manual (included with screen creation software)*

### ■ MONOPOLIZE TIME (0 to 2550s)

This field controls the length of time for the monopolize process when no other touch panel operations are performed. The Monopolize process begins when the System Data Area's 7th bit of word address LS14 turns ON, and ends either when the bit turns OFF, or when the time set here elapses.



- Pressing the touch panel in the middle of the monopolize process interrupts the MONOPOLIZE TIME function, and ends exclusive use.
- When MONOPOLIZE TIME is set to 0, the monopolize function does not end automatically.

**Reference** For further information about the contents of System Data Area LS6 (status) and LS14 (control), refer to *GP-PRO/PBIII for Windows Device/PLC Connection Manual (included with screen creation software)*



### 6.5.4 Ethernet Setup

This menu is for Ethernet settings. This information is used as setting data during GP setup or screen transfer, or, if the Pro-Server software is used, for the 2-Way Driver. (Only GP-2300 Series units.)

The diagram illustrates the transition from the 'EXTENDED SETUP' menu to the 'ETHERNET SETUP' menu. In the 'EXTENDED SETUP' menu, the 'ETHERNET SETUP' option is highlighted. An arrow points to the 'ETHERNET SETUP' menu, which contains the following fields: 'MY IP ADDR.' with four input boxes for octets, 'SUBNET MASK' with four input boxes, 'MY PORT NO.' with a single input box containing '8000', and 'GATEWAY' with four input boxes. 'SET' and 'ESC' buttons are located in the top right corner of the 'ETHERNET SETUP' menu.



- **Enter the “ETHERNET SETUP” settings after receiving information from your network’s system administrator.**
- **Be sure to enter a unique IP address, not one used for other GPs or by the host.**

#### ■ MY IP ADDRESS

Sets up the GP’s IP address. The IP address is 32 bits and designated in four 8-bit units, entered in decimal.



**Note:** To use Ethernet networking, click on [Initial Settings], [PLC Setup], [PLC Setup] and [Ethernet Setup].

#### ■ SUBNET MASK

Sets the subnet mask. If you are not using a subnet mask, designate “0”.



**Note:** To use Ethernet networking, click on [Initial Settings], [PLC Setup], [PLC Setup] and [Ethernet Setup].

#### ■ MY PORT NO.

Sets the 2-Way Driver Port No. using a value from 1025 to 65526. Starting from the value entered here, a total of 10 consecutive ports can be used. The default setting is [8000].



**Note:** To use Ethernet networking, click on [Initial Settings], [PLC Setup], [PLC Setup] and [Ethernet Setup] and select the corresponding Ethernet protocol Port No.

#### ■ GATEWAY

Sets up the gateway’s IP address. Only a single gateway can be set up. If you are not using a gateway, enter “0”.

### 6.5.5 SYSLOG Setup

---

These settings are used for outputting 2-Way driver's operation logs. Therefore, if you are not using the Pro-Server software, these settings are not necessary. (Only GP-2300 Series units.)

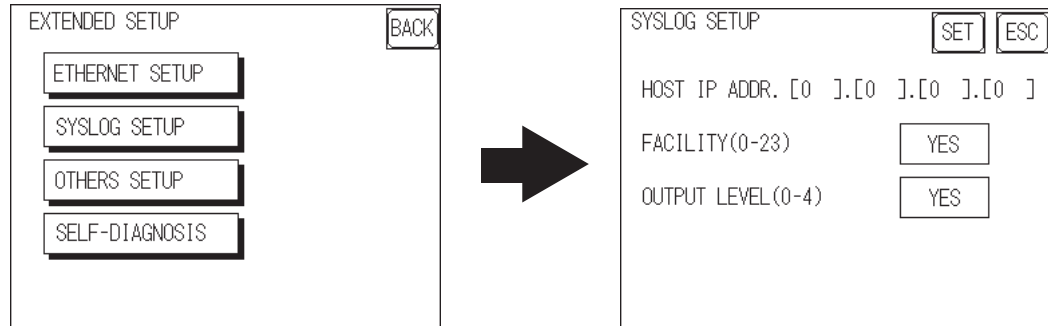

#### ■ HOST IP ADDRESS

Sets up the IP address of the host computer, where the 2-Way driver's operation logs will be output.

#### ■ FACILITY (0-23)

Sets up the facility.

#### ■ OUTPUT LEVEL (0-4)

Sets up the output level.

**▼Reference▲** For details about Pro-Server and SYSLOG, refer to **Pro-Server with Pro-Studio for Windows Operation Manual** (included in the Pro-Server with Pro-Studio for Windows software package)

### 6.5.6 Others Setup

---

Designates the GP operation performed when a 2-Way driver error occurs.

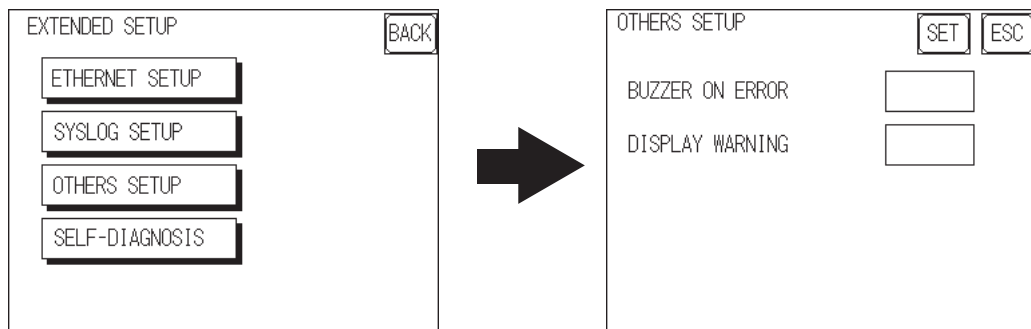

#### ■ BUZZER ON ERROR

Enables/disables the buzzer sound output produced when an error related to the 2-Way driver operation occurs.

#### ■ DISPLAY WARNING

Enables/disables the warning message display used when an error related to the 2-Way driver operation occurs.

### 6.5.7 Self-Diagnosis

---

Runs the Self Diagnosis program for the Ethernet operation. The GP must be connected to the Ethernet network prior to running this program. (Only GP-2300 Series units.)

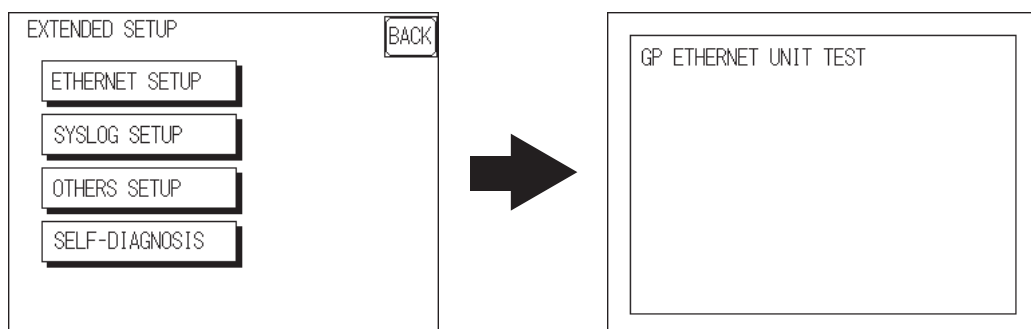

When there is no error detected, the message “OK” will appear. If an error is detected, the message “NG” will appear.

Be sure that this Self Diagnosis program is used only for the Ethernet operation. If you wish to run the general Self Diagnosis program, use [Main Menu]’s [Self Diagnosis] feature.

▼ **Reference** ▲ 7.2 Self Diagnosis

## 6.6 Initialize Internal Memory

This section explains how to initialize the GP's internal data or a CF card inserted in the GP. Select one of the menu items, [INITIALIZE MEMORY], [INITIALIZE CF CARD] and [CSV DATA INDEX] selections in the [INITIALIZE MEMORY] menu.

### 6.6.1 Initialize GP Memory



This command erases all the GP screen data and initializes the GP's SRAM.

- **You cannot cancel the Initialization procedure after pressing the Start key.**
- **All backed up data in SRAM is lost.**
- **Initialization does not erase the SYSTEM SET UP, the SIO protocol, or the internal clock settings.**

To initialize the GP internal memory, enter the common password **1101**, or the password entered in the SYSTEM SET UP screen.

**Reference** For details about entering the password's numeric values, refer to **5.3 Initialization**



**Note:** The time required for Initialization is between 10 and 20 seconds.

### 6.6.2 Initialize CF Card



Deletes all data in the CF Card installed in the GP.

**Initialization cannot be canceled once the START switch is touched.**

Initializes the CF Card. Enter the common password “**1101**” or the password you designated in the “SYSTEM SET UP” menu.

**Reference** For details about entering the password's numeric values, refer to **5.3 Initialization**

## Chapter 6 - Initializing the GP

### 6.6.3 CSV Data Index

Specific data-transfer CSV files (ZR\*\*\*\*\*.CSV) on the CF Card can be transferred from the CF Card directly to the PLC (filing) or from the PLC directly to the CF Card (logging). For the details about the CSV Data Transfer Function,

▼ **Reference** ▲ *GP-PRO/PB III for Windows Tag Reference Manual.*

Here creates the index file of the CSV files that are saved into the CF card with the CSV data transfer function.

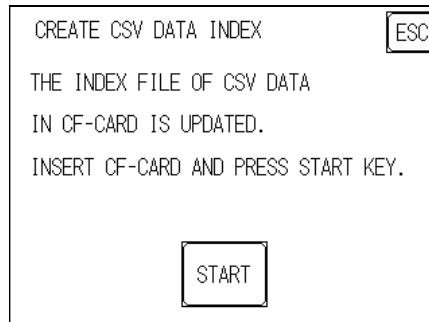

Touch the [START] key, then the operation to create the index file will start.



**Do not open the CF card cover during the operation to create the index file. The data may be damaged.**



**Too many number of CSV files may cause a time loss for creating the index file. It will take about 10 minutes for creating an index file of the 4,000 CSV files.**

If you touch the [ESC] key during the operation to create the index file, the operation will stop, then the following screen will appear.

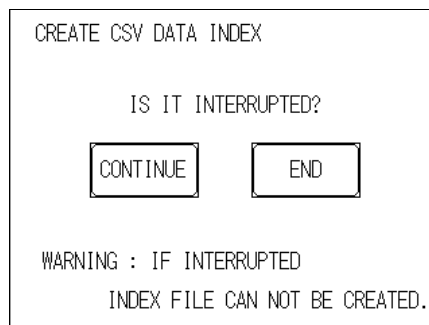

#### ◆ CONTINUE

The operation restarts. When the message "CREATED INDEX FILE. PLEASE PRESS END KEY" appears, finish the program.

#### ◆ END

Deletes the creating index file, then the [INITIALIZE MEMORY] screen will reappear.

## 6.7 Set Up Time

---

SET UP TIME	SET	ESC
PRESENT TIME		
'	Y.	M. D. :
TIME SET UP		
'	<input type="text"/> Y.	<input type="text"/> M. <input type="text"/> D. <input type="text"/> : <input type="text"/>

Sets the GP's internal clock.

### ■ SET UP TIME

Enter date and time corrections to the date and time displayed in the PRESENT TIME.



**Note:** The GP's internal clock has a slight error. At normal operating temperatures and conditions, with the GP operating from its lithium battery, the degree of error is 65 seconds per month. Variations in operating conditions and battery life can cause this error to vary from +65 to -350 seconds per month. For systems where this degree of error will be a problem, the user should be sure to monitor this error and make adjustments when required.

## 6.8 Set Up Screen

The initial screen display upon powering up, the character size when in RUN mode, and other general screen items are setup here.

SET UP SCREEN		SET	ESC
INITIAL SCREEN NO.	B	1	
ALARM MESSAGE V SIZE		1	
H SIZE		1	
ONLINE ERROR DISPLAY		ON	

### ■ INITIAL SCREEN NO.

Set up the screen file number that will display first upon powering up. If the BIN option for DATA TYPE OF SCREEN NO in SYSTEM SET UP had been selected, enter a number from 1 to 8999. Or, if BCD was the option set up, then input a number from 1 to 1999.

### ■ ALARM MESSAGE

Set up the character size of the ALARM MESSAGE when the Alarm Bulletin is activated.

<When using syngle-byte characters>

1	2	4
V size=1; H size=1 16×8 pixels	V size=2; H size=2 32×16 pixels	V size=4; H size=4 64×32 pixels

<When using double-byte characters>

V size=1; H size=1 16×16 pixels	V size=2; H size=2 32×32 pixels	V size=4; H size=4 64×64 pixels
------------------------------------	------------------------------------	------------------------------------

### ■ ONLINE ERROR DISPLAY

Set up whether or not error messages display during RUN mode.

## 6.9 Font Setting

---

FONT SETTING	SET	ESC
FONT SETTING	JAPAN	
KANJI FONT QUALITY	HIGH	

### ■ FONT SETTING

Selects the font type displayed on the GP screen during operation.

### ■ KANJI FONT QUALITY

Designates the font display quality for enlarged characters.

#### ◆ When [FONT SETTING] is set to [JAPAN]

Single-byte characters will remain 8x16-dot characters when they are enlarged.  
Double-byte characters are displayed as:

- [Standard] ..... Here, characters are displayed using 16x16-dot "blocks".  
When enlarged, this font will remain a 16x16-dot character.  
(Compatible with GP-\*30 series units.)
- [HIGH(1)] ..... When enlarged to double size, Level 1 JIS Kanji Code characters are displayed as 32x32-dot characters. Level 2 JIS Kanji Code characters remain 16x16-dot characters.  
(Compatible with GP-\*50 series and GP-70 series units.)
- [HIGH(1,2)] ..... When enlarged to double size, both Level 1 and Level 2 JIS Kanji Code characters are displayed as 32x32-dot characters.

#### ◆ When [FONT SETTING] is set to any other type (i.e. CHINESE, I-ASCII, KOREA or TAIWAN)

- [Standard] ..... Half-size (single-byte) characters are displayed as 16x8-dot characters.  
Full-size characters, regardless of the display size used, will always be displayed as 16x16-dot characters. When enlarged, this font will stay as 16x16-dot character. (Compatible with GP-\*30Series units)



## Chapter 6 - Initializing the GP

- [HIGH(1)] ..... All half-size (single-byte) characters (ASCII code: 21h to 7Dh, i.e. alphanumeric characters) except " ^ " and " ' " will display as high quality characters.
- 16x16-dot or larger characters will display as high quality 16x16 fonts.
  - 32x32 or larger characters will display as high quality 32x32 fonts.
- Full-sized (double-byte) characters will display as 16x16-dot characters and remain 16x16-dot characters when enlarged.
- [HIGH(1,2)] ..... All single-byte characters (ASCII code: 21h to 7Dh, i.e. alphanumeric characters) except " ^ " and " ' " will display as high quality characters.
- When 16x16 dots are used for a character, it will display as a high quality 16x16 character.
  - When 32x32 or larger dots are used for a character, the character will display as a high quality 32x32-character.
- Full-sized (double-byte) characters (i.e. [KOREA], [TAIWANESE] and [CHINESE]) will display as 32x32-dot characters when enlarged to 32x32-dot or larger characters.

# Chapter

# 7 RUN Mode and Errors

1. RUN Mode
2. Self-Diagnosis
3. Troubleshooting
4. Error Messages
5. Error Message Details

## 7.1 RUN Mode

There are two ways of entering the GP's RUN mode; immediately after plugging in the unit's power cord, or from the GP's OFFLINE mode.

### 7.1.1 After Connecting the Power Cord

The method of GP startup will vary, depending on the "START TIME" setting in the "Initialization Settings" / "System Setup" area.

#### ■ When START TIME is set to "0"

When the GP's power cord is connected, the version information screen shown below will appear. Next, the screen designated by the initialization screen file number ("Initialization Settings" / "System Setup" area) will appear, and the GP will start to communicate with the PLC.

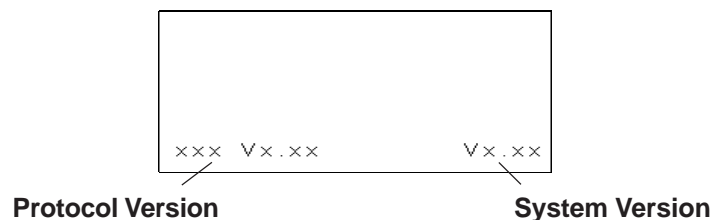

#### ■ When START TIME is set to any value other than "0"

In this case, when the GP's power cord is connected, the following version information screen will appear. In the top right corner of the screen, a value will appear and count down the number of seconds designated by the "START TIME" setting. Next, the screen designated by the initialization screen file number ("Initialization Settings" / "System Setup" area) will appear, and the GP will start to communicate with the PLC.

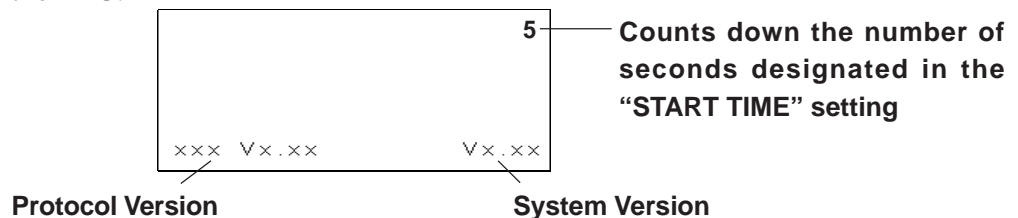

If the initialization screen's file number is not designated, or a number is designated that does not exist, the version information screen will remain.



**Note:** There is a possibility that the screens shown above may not display in the beginning depending on the display device's start-up time.

## Chapter 7 - RUN Mode and Errors

### 7.1.2 Via OFFLINE Mode

Touch the MAIN MENU's RUN selection to start your downloaded "project". The INITIALIZE area's SET UP SCREEN feature designates the first screen that appears in RUN mode, and, after this screen appears, communication with the PLC begins. If, however, the designated initial screen has not been created, or does not exist, the above display will remain.

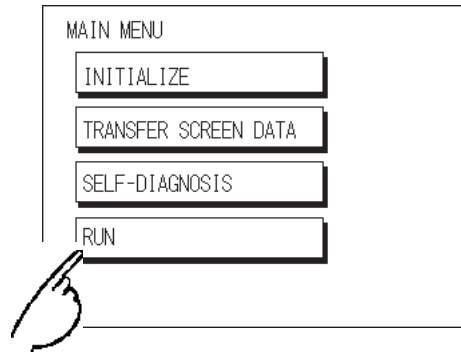

**Note:** To enter OFFLINE Mode, simply touch the top left corner of the GP's screen within 10 seconds after connecting the GP's power cord.



**After powering up the GP, the initial screen that appears is equipped with a built-in (invisible) switch in the top left corner. Touch this switch within 10 seconds to change the GP from RUN to OFFLINE mode.**

E.g.

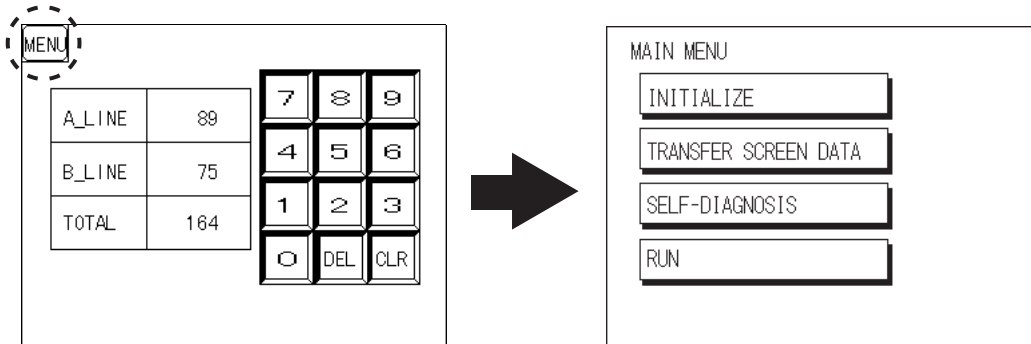

## 7.2 Self-Diagnosis

The GP unit is equipped with a number of self-diagnosis features used to check its System and Interfaces for any problems.

### 7.2.1 Self-Diagnosis Item List

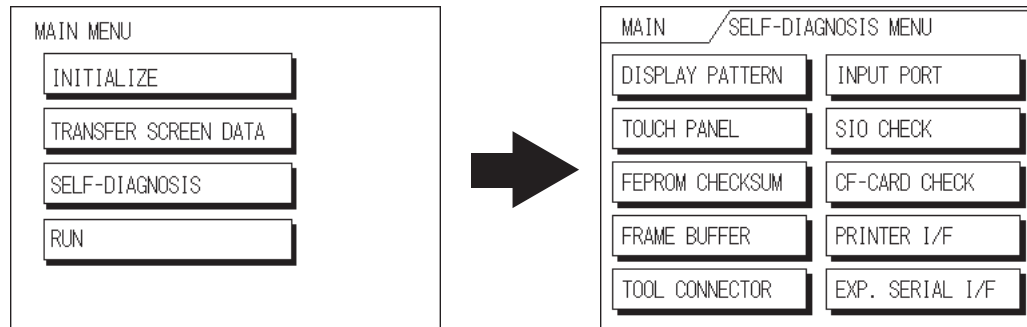

- Checks all the figures and tiling patterns.
- Checks each GP touch panel square.
- Checks the System and Protocol of the GP Internal Memory (FEPROM).
- Checks the internal display memory (Frame Buffer).
- Checks the Tool Connector control lines and send/receive lines.\*<sup>1</sup>
- Checks the Input Port (for Digital's maintenance use only).
- Checks the RS-232C and RS-422 send/receive lines.\*<sup>1</sup>
- Checks the status of the CF Card.\*<sup>1</sup>
- Checks the printer interface.\*<sup>1</sup> (Only the GP-2300 Series can perform this self-diagnosis.)
- Checks the status of the Expansion Serial I/F.\*<sup>1</sup> (Only the GP-2300 Series can perform this self-diagnosis.)

The following pages explain each item's details.



**Note:** The menu screen is the common for both GP-2300 Series and GP-2301 Series.

\*<sup>1</sup> This item requires the use of special equipment (cable, connector, etc.).

## Chapter 7 - RUN Mode and Errors

### 7.2.2 Self-Diagnosis - Details

---

This section explains the contents of SELF-DIAGNOSIS. For information on how to operate the Screen, **Reference** Chapter 5, "OFFLINE Mode"; for information about how to set up the Special Tools, **Reference** Chapter 3, "Installation and Wiring".

#### ■ DISPLAY PATTERN

Used when the buzzer will not sound and when the device contents will not display correctly to check the drawing function. It does this by running checks on the various screen pattern displays (8 screens), the ON/OFF Display, and KANJIROM CHECKSUM. When the ON/OFF Display is checked, the Buzzer ON/OFF check is run simultaneously. If KANJIROM CHECKSUM is normal, **OK** displays; if there is a problem, **NG** displays.

#### ■ TOUCH PANEL

Touch Panel check. Checks if each touch cell highlights when pressed.

#### ■ INTERNAL FEPRM CHECKSUM (System + Protocol)

The Internal FEPRM System and Protocol check searches for any problems that may arise during operations. When running the check, the screen will change as follows.

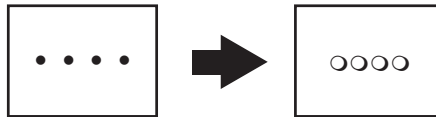

When the FEPRM is normal, **OK** displays; if there is a problem, the screen stops in the middle of operation. This check does not erase the System or Protocol.

#### ■ FRAME BUFFER

The Frame Buffer (display memory) Check looks for any display problems that may develop. When everything is normal, **OK** displays; when there is a problem, an error message displays.

## Chapter 7 - RUN Mode and Errors

### ■ TOOL CONNECTOR LOOP BACK

Use the Tool Connector Control line and Send/Receive line check when the GP cannot send and receive data from the PC. To run the check, connecting a *Tool Connector Check Loop Back Cable* (Dsub9 pin, pin-side) mounted to the *Downloading Cable* (provided in the software package) is necessary.

When everything is normal, **OK** displays; when there is a problem, an error message displays.

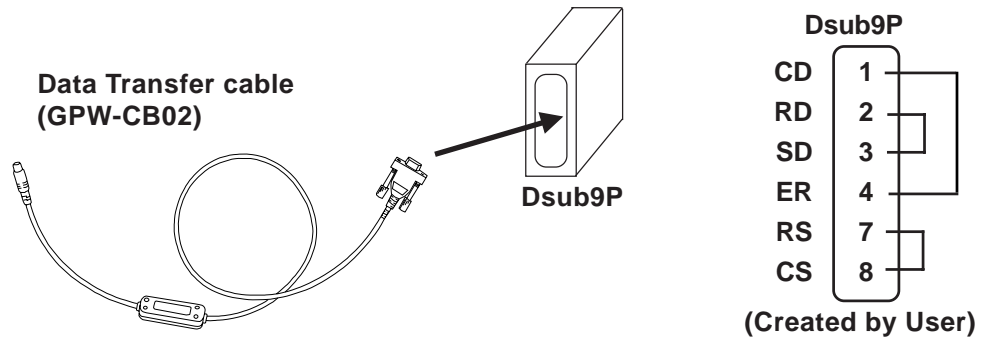

### ■ INPUT PORT

Used for Digital's maintenance.

### ■ SIO CHECK

Checks the RS-232C and RS-422 SIO lines for areas where communication problems develop. In the menu, select which check to run. To run the check, connecting the SIO cable is necessary. If all is normal, **OK** displays; if there is a problem, an error message appears.

The SIO cable wiring is as shown below. (RS-232C, RS-422 common)

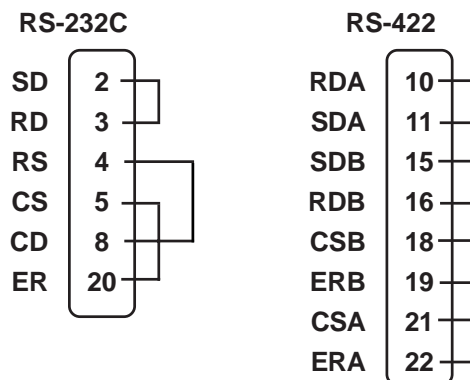

### ■ CF CARD

Checks the CF Card's Read/Write. Prior to using this check menu, you need to insert the CF Card in the GP. The CF Card needs to have more than 1K bytes usable space. If there is no error, the message [OK] will appear. If there is an error, an error message will appear.

## Chapter 7 - RUN Mode and Errors

### ■ CF CARD CHECKSUM

Takes the Checksum of the CF Card's files and operates the check. Prior to using this check menu, you need to insert the CF Card in the GP. This check menu can check the following files.

- Filing Data
- CF Card's Image Data
- CF Card's Sound Data

When the check is finished, the following items will appear on the screen.

- The number of checked files
- The number of files that have an error
- The file name where the most recent error occurred

### ■ CF CARD MEMORY LOADER FILE CHECK

Checks the CF Card's Memory Loader Tool when it does not start. If there is no error, the message [OK] will appear. If there is an error, the message [NG] will appear.

### ■ PRINTER I/F

Checks the printer I/F. Used when the printer does not function properly. You need to connect the printer prior to using this checking menu.

Connecting the printer buffer may cause an error, therefore, connect the GP and the printer directly.

If there is no error, (ASCII Code: 20 to 7D<HEX> and A0 to DF<HEX>) will be output (printed) and the message [OK] will appear on the screen. If there is an error, an error message will appear.

(Only GP-2300 Series units have this feature.)

### ■ EXPANSION SERIAL I/F

Checks the Send/Receive line of the Expansion Serial Interface when an abnormality occurs. To run the check, you must connect the SIO cable. If all is normal, the message [OK] appears. If there is a problem, an error message appears.

(Only GP-2300 Series units have this feature.)

The SIO cable wiring is as shown below.

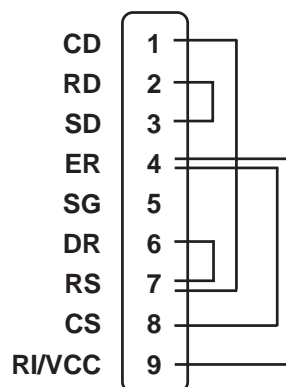

### 7.3 Troubleshooting

---

This section describes how to find and resolve problems that may occur on the GP. If there is a problem with the PLC, please refer to the corresponding PLC manual.

#### 7.3.1 Possible Types of Trouble

---

The following items are problems that may occur while using this unit.

**(A) No Display**

The screen will not display even when the unit is powered On. Also, during RUN mode, the screen disappears.

**(B) No GP/HOST Communication**

The GP unit cannot extract data from the host. An error message may appear on the screen as a result.

**▼Reference▲** *This chapter's "7.4 Error Messages"*

**(C) Touch Panel Does Not Respond**

The touch panel does not react when pressed, or the reaction time is very slow.

**(D) Buzzer Sounds when GP power is turned ON**

The GP goes to the OFFLINE mode unexpectedly while operating, or the GP automatically goes to the OFFLINE mode when the power is turned ON.

**(E) Clock Settings Cannot be Entered**

Even after clock settings are entered, the GP unit's clock settings remain eg.00/01/01.

**(F) OFFLINE displays During RUN Mode**

The GP's buzzer will sound intermittently after power is first turned ON.

For these first five problems, see the troubleshooting tables on the following pages.

For the last problem (F), a SYSTEM ERROR may have developed while displaying the OFFLINE mode screen.

**▼Reference▲** *This chapter's "7.5 Error Message Details"*

Be sure that no object has touched the screen accidentally if the GP goes to the OFFLINE mode without displaying an error message when the power turned ON. If any object may have possibly touched the top left corner of the screen within 10 seconds after the power turned ON, that may cause the GP to go OFFLINE.



# Chapter 7 - RUN Mode and Errors

## 7.3.2 No Display

Follow the flowchart below when the screen does not display when powering up, or the screen turns OFF by itself during RUN mode, to find an appropriate solution.

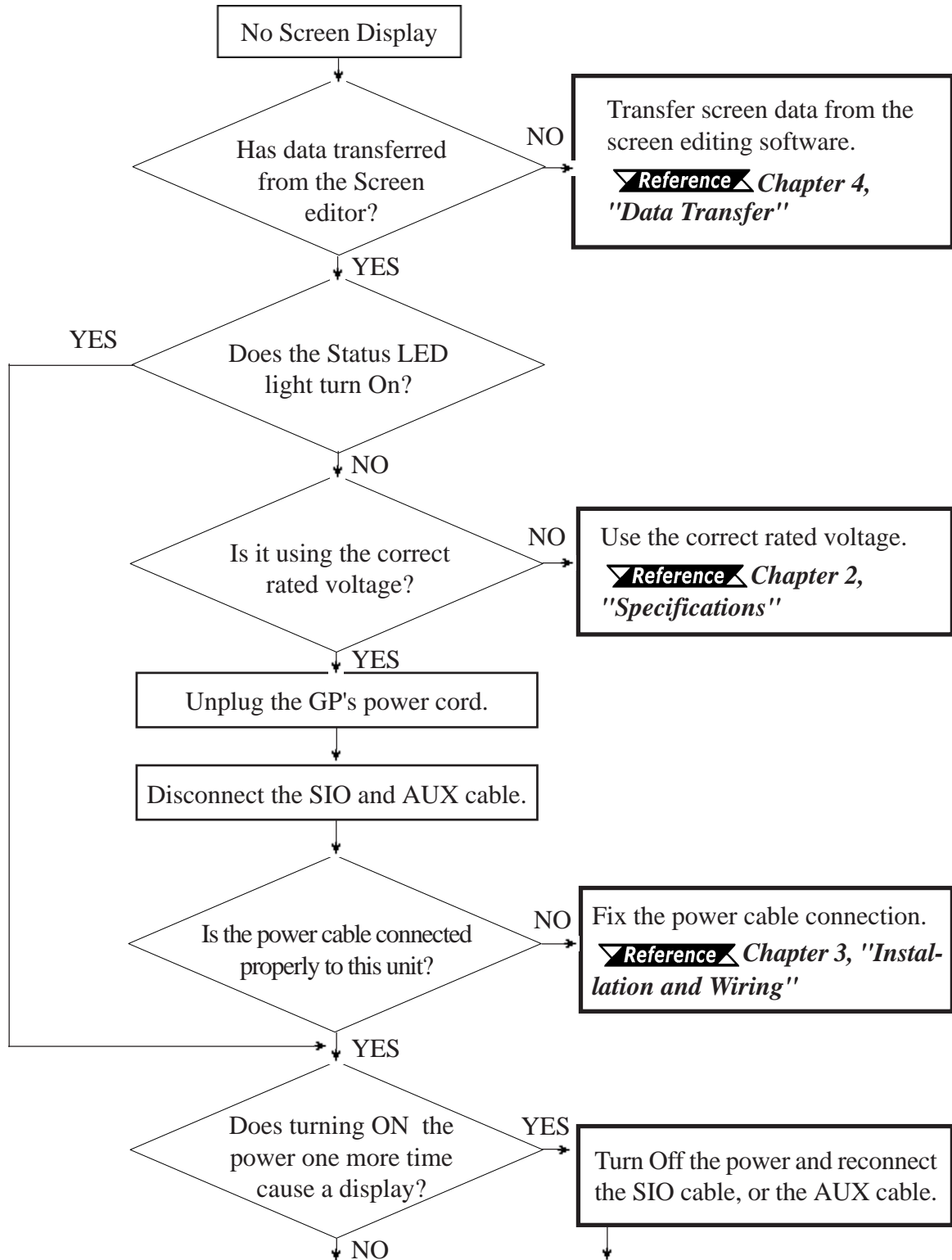

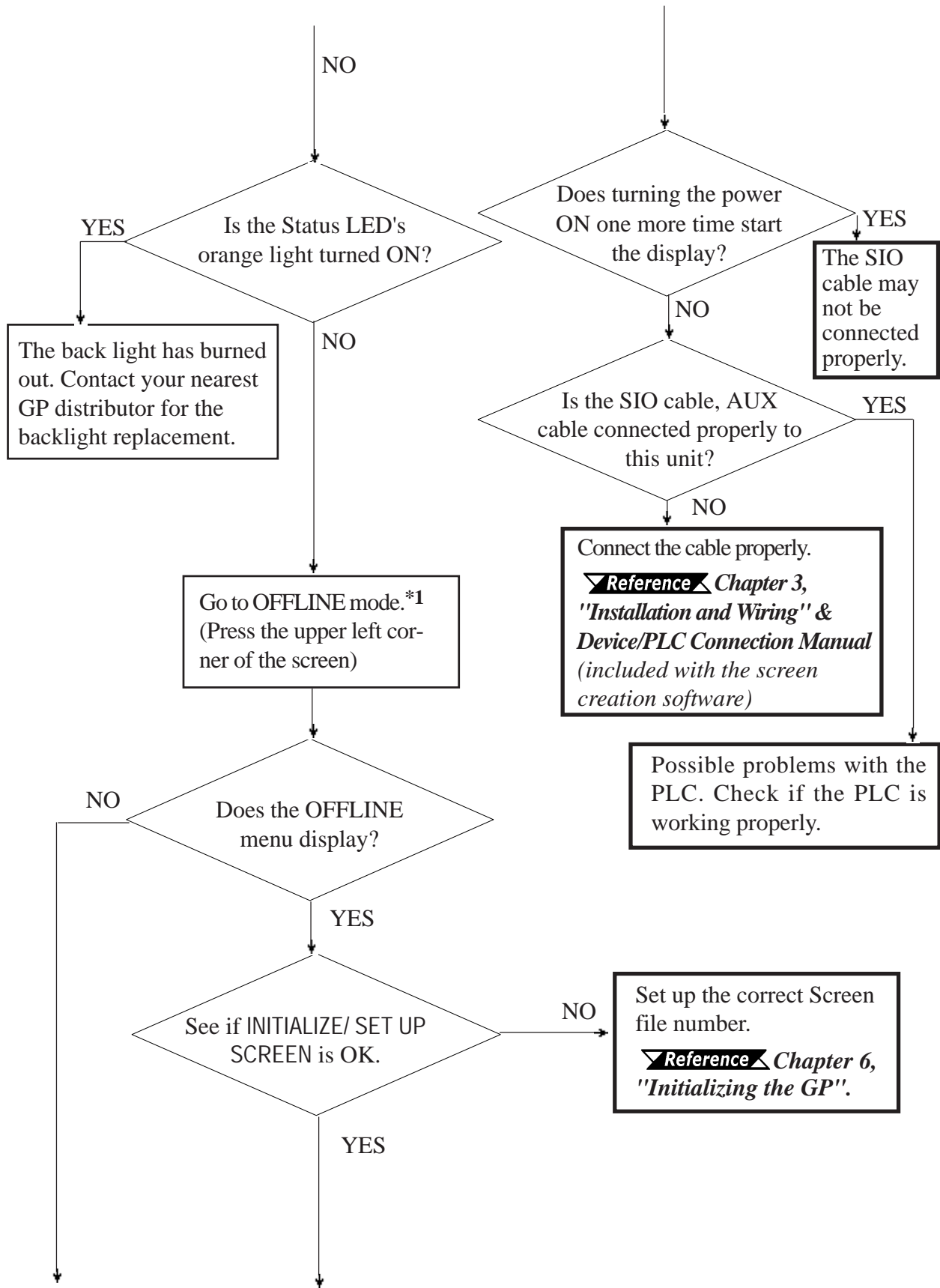

*\*1 To make the OFFLINE screen appear, turn the power OFF, then ON, and press the upper left corner of the screen within 10 seconds.*

## Chapter 7 - RUN Mode and Errors

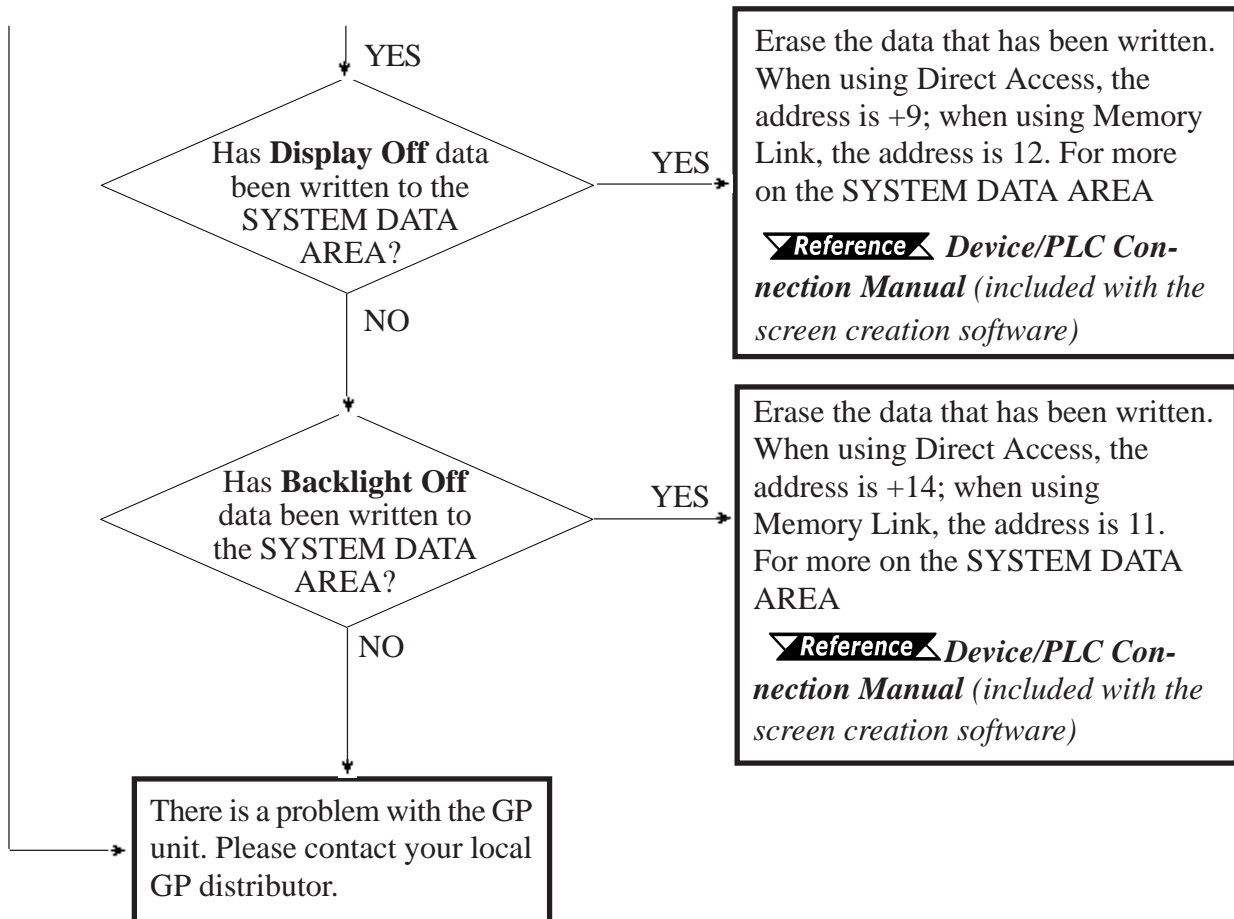

## 7.3.3 No GP/Host Communication

When the GP will not communicate with the host PLC, follow the flowchart below to find both the cause of the problem and a suitable response.

Or, if an error message displays on the screen, check the error code (refer to the *Error Messages* section in this chapter) to find the appropriate solution.

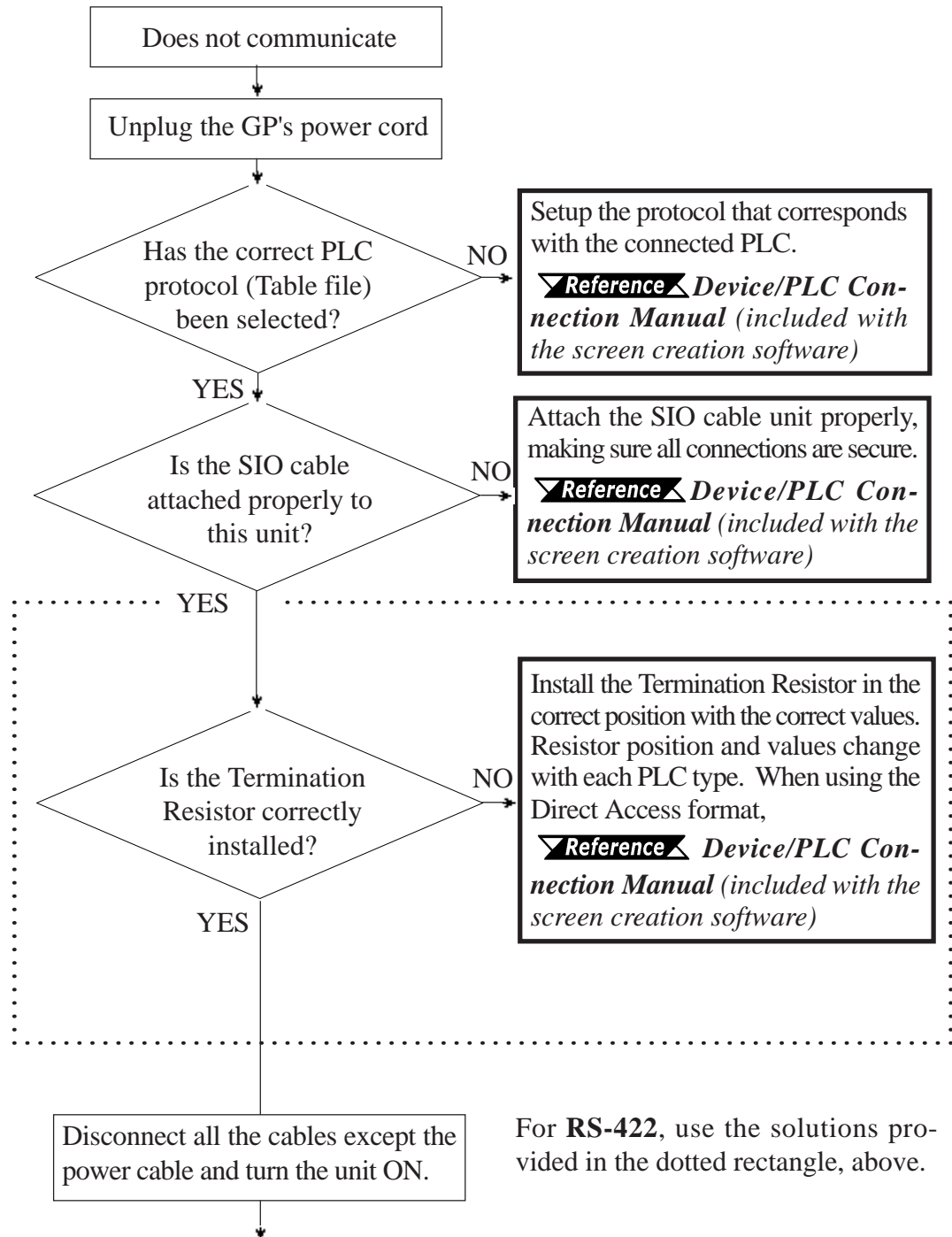

## Chapter 7 - RUN Mode and Errors

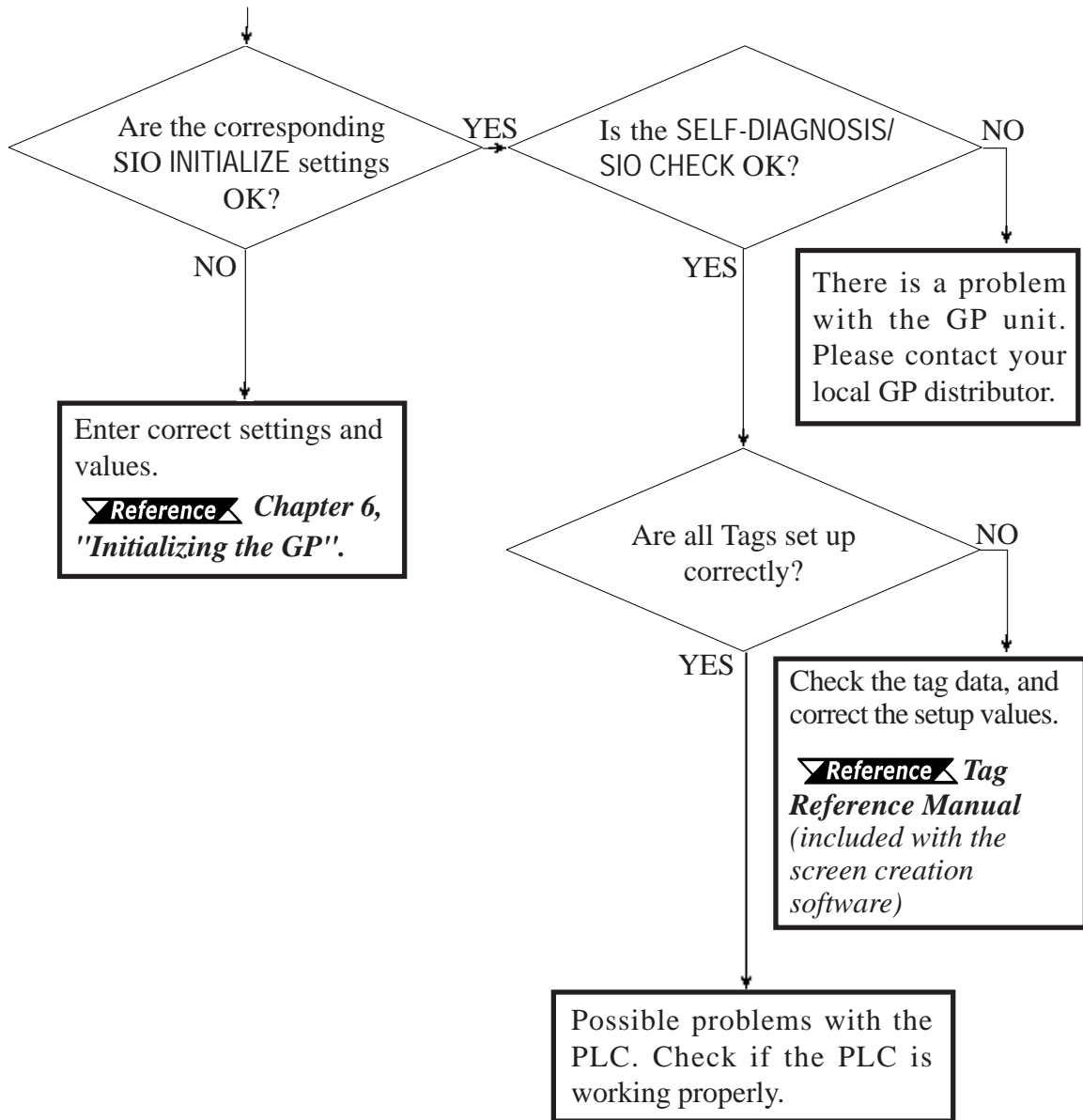

## 7.3.4 Touch Panel Does Not Respond

When the touch panel does not respond, or its response time is very slow after it is pressed, please use the flowchart below to find the origin of the problem, and the appropriate solution.

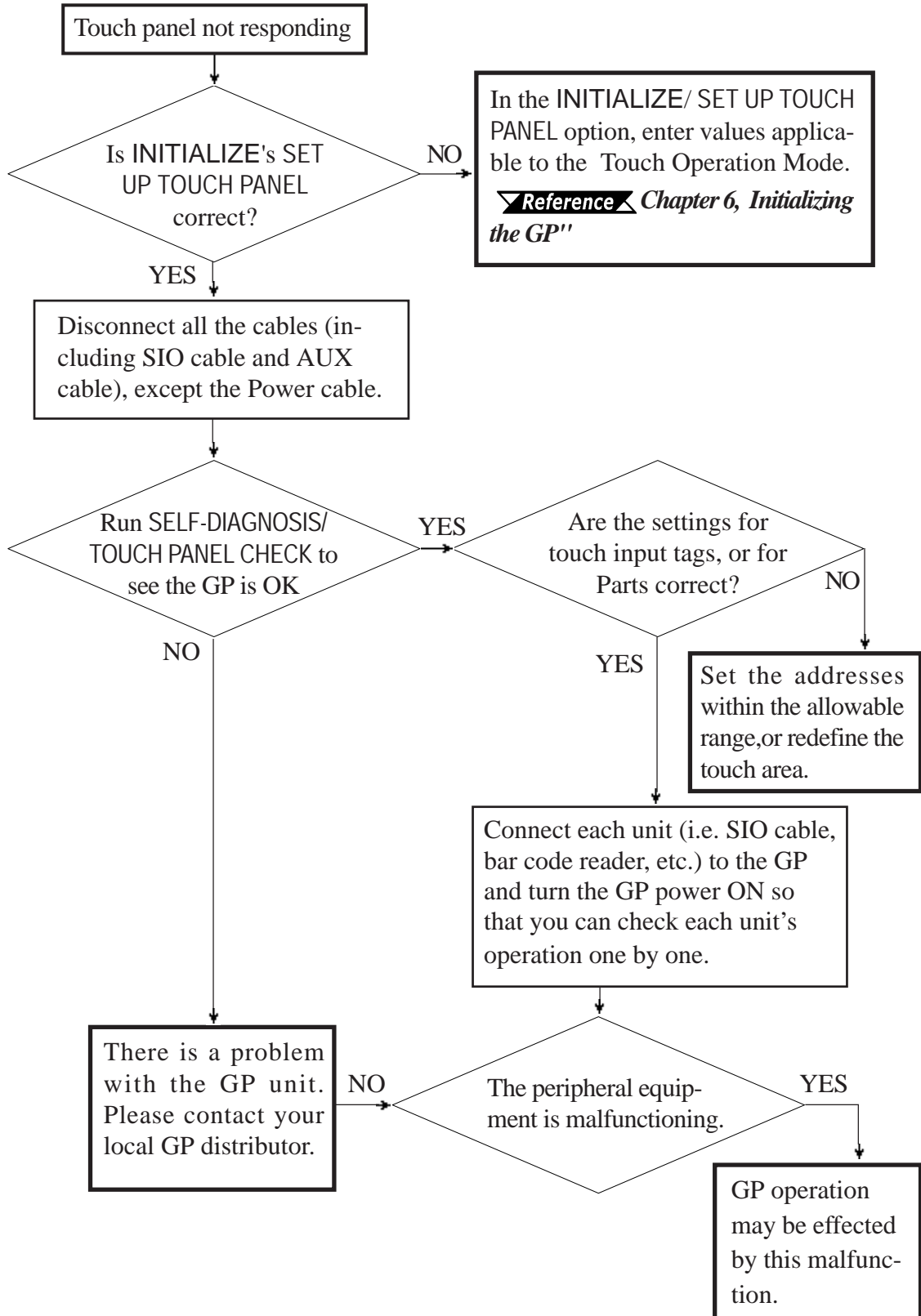

## Chapter 7 - RUN Mode and Errors

### 7.3.5 Buzzer Sounds when GP power is turned ON

If you start the GP unit and the internal buzzer sounds, use the following chart to find the reason and the appropriate solution.

Buzzer Sound	Timing	Reason	Solution
Continuous beep (approx. 1 sec. intervals)	When power to the GP is turned ON	The GP's system program is destroyed.	Send the correct GP system program from the screen creation software to the GP, via the Transfer screen's "Forced Setup" feature.
			Turn on the GP's dip switch #1 (next to CF Card slot) and use the CF Memory Loader Tool to set up the GP.
Two beeps - Repeating (approx. 1 sec. intervals)	When power to the GP is turned ON	A different GP unit's system program has been accidentally installed in this GP.	Send the correct GP system program from the screen creation software to the GP, via the Transfer screen's "Forced Setup" feature.
			At this time an error will appear on the Screen Creation Software's screen, however, simply turn the GP's power supply OFF and then ON, and data transfer will automatically start.
Three beeps - Repeating (approx. 1 sec. intervals)	When the GP's dip switch #1 is turned on (next to CF Card slot) and power to the GP is turned ON.	The CF Card's Memory Loader Tool (MLD****.SYS) file is missing, or destroyed.	Reformat the CF Card and replace the CF Card's Memory Loader Tool file.
	When the GP is started via the Menu Bar's "CF BOOT" key.	The CF Card's Memory Loader Tool (MLD****.SYS) file is missing.	
Four beeps - Repeating (approx. 1 sec. intervals)	When the GP is started via the Menu Bar's "CF BOOT" key.	The CF Card's internal boot program (IPL.SYS) is destroyed.	Reformat the CF Card and replace the CF Card's Memory Loader Tool file.

If the CF Card's boot-up program (IPL.SYS) or the Memory Loader Tool (MLD\*\*\*\*.SYS) programs appear to be damaged or destroyed, use the GP's internal diagnostic program "CF Card Memory Loader File Check" utility to confirm the condition of these files.

**Reference** 7.2 *Self-Diagnosis*

### 7.3.6 Clock Settings Cannot be Entered

---

This problem occurs when the lithium backup battery's voltage, used for the internal clock, runs out. To enter the clock settings, please read the CLOCK SET UP ERROR directions.

▼**Reference**▲ *7.5.4 Clock Setup Error*

### 7.3.7 Error Screens

---

If the following error screen appears when you start the GP, it indicates an error has occurred and the GP is not set up correctly. Be sure to perform screen transfer (Force System Setup) again.

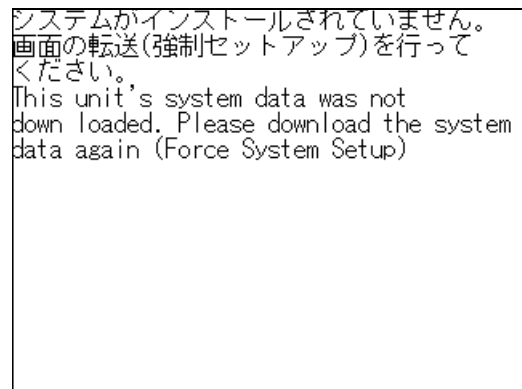

システムがインストールされていません。  
画面の転送(強制セットアップ)を行って  
ください。  
This unit's system data was not  
down loaded. Please download the system  
data again (Force System Setup)





### 7.4 Error Messages

This section explains the messages that appear when an error has occurred in the GP unit during RUN mode. The problem causing the error message and its related countermeasure are explained in the table below.

After a problem has been solved, unplug the GP's power cord and then reattach it.  
*(Only the latest error message will appear on the GP screen)*

#### 7.4.1 Error Message List

Error Message	Problem	Countermeasure
<b>SYSTEM ERROR</b> (03 : **)	During screen data transfer, an unrecoverable error occurred.	 <b>Reference</b> <i>7.5 Error Message Details</i>
<b>SYSTEM ERROR</b> (*** : *** : ***)	During screen data transfer, an unrecoverable error occurred.	 <b>Reference</b> <i>7.5 Error Message Details</i>
<b>ILLEGAL ADDRESS IN SCREEN DATA</b>	Settings are used that overlap addresses.	Set the addresses correctly after checking the screen data.
<b>UNSUPPORTED TAG IN SCREEN DATA</b>	The GP currently in use does not support the desired Tag.	Set the Tag correctly after checking the screen data.
<b>PLC NOT CONNECTED</b> (02 : FF) and (02 : F7)	The communication cable is not connected correctly.	Re-connect the communication cable correctly.
<b>PLC NOT RESPONDING</b> (02 : FE)	PLC's power is not turned ON.	Turn ON the PLC's power.
	GP unit INITIALIZE settings (Setup I/O, PLC Setting) are incorrect.	Check the INITIALIZE settings and make any necessary corrections.
	The GP unit is turned ON before the PLC's power is ON.	Turn ON the PLC's power and wait for 2-3 seconds, then turn ON the GP's power.
	The communication cable is not connected properly.	Check the communication cable and connect it correctly.
<b>RECEIVE DATA ERROR</b> (02 : FD)	The communication cable was disconnected while the GP was ON.	Turn the GP OFF and then ON again.
	The GP is powered OFF, then ON during communication with PLC.	Turn the GP OFF and then ON again.
	Noise occurred in the communication cable.	Check the communication cable and connect it correctly.
<b>GP STATION NO. DUPLICATION ERROR</b> (02 : F9)	This GP's station number is same as another GP.	Check all GP station numbers, and set them so they are all unique.
	PLC is powered OFF, then ON during communication with GP.	Turn the GP OFF and then ON again.

## Chapter 7 - RUN Mode and Errors

Error Message	Problem	Counter Measure
<b>NETWORK ADDRESS ERROR (02 : F8)</b>	The SIO address used for this GP is different from other GP's. (Only for the Multi-Link connection)	Check all GP's SIO address settings, and correct any that are incorrect.
<b>PLC COM. ERROR (02 : **)</b>	Specific PLC related error, or an error has occurred with the PLC.	▼ <b>Reference</b> ▲ <i>7.5 Error Message Details</i>
<b>SCREEN MEMORY DATA IS CORRUPT (nnnn:mmmm)</b>	ScreenData is corrupted: *nnnn indicates the Screen Number that has an error. *mmmm indicates the number of screens that have errors.(Decimal)	Check the screens that have errors, correct all errors, and then transfer the screen data again.
<b>CLOCK SETUP ERROR</b>	The backup battery for the internal clock is running low.	▼ <b>Reference</b> ▲ <i>7.5 Error Message Details</i>
<b>SCREEN TRANSFER ERROR</b>	An error occurred in the data transmission from the screen editor to the GPpanel.	Re-transfer the screen data.
<b>SCREEN TAG LIMIT EXCEEDED</b>	Tags are setup beyond the tag limit (max. of 385.)	▼ <b>Reference</b> ▲ <i>7.5 Error Message Details</i>
<b>OBJ. PLC HAS NOT BEEN SETUP (**)</b>	The host PLC set up in the Editor program does not match the PLC in use.	▼ <b>Reference</b> ▲ <i>7.5 Error Message Details</i>
<b>CF CARD RECOGNITION ERROR</b>	The CF Card is not a GP compatible type.	Use Pro-face's optional CF Card.
	The timing of the CF Card's insertion was incorrect, and the GP unit cannot recognize it.	Reinsert the CF Card, or turn the GP ON/OFF with the CF Card inserted.
<b>D-SCRIPT ERROR (***)</b>	D-Script settings (data) are incorrect.	▼ <b>Reference</b> ▲ <i>7.5 Error Message Details</i>
<b>GLOBAL D-SCRIPT ERROR (***)</b>	Global D-Script settings (data) are incorrect.	▼ <b>Reference</b> ▲ <i>7.5 Error Message Details</i>
<b>EXTENDED SIO SCRIPT ERROR (***)</b>	Extended SIO script settings (data) are incorrect.	▼ <b>Reference</b> ▲ <i>7.5 Error Message Details</i>

# 7.5 Error Message Details

---

### 7.5.1 System Errors

---

Indicates a fault in the basic operations of the GP.

Following the error message, an error code, as shown below, will appear. Report the error number and details on how the error developed to your local GP distributor.

◆ **SYSTEM ERROR ( 03 : x x )**

An unrecoverable error occurred during screen data transfer.

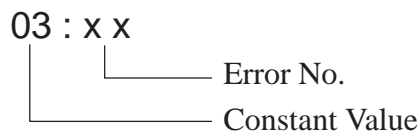

◆ **SYSTEM ERROR ( x x x : x x x : x x x )**

An unrecoverable error occurred during screen data transfer.

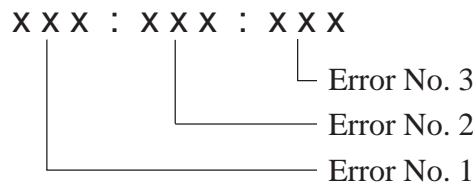

#### Possible Solutions

- Check if the GP's Power Cord and the Input signal line have been wired separately from each other.
- Check that the FG line has been grounded correctly, according to your country's standards.
- Re-send the screen data from the PC to the GP.
- If other types of communication errors, such as [RECIEVE DATA ERROR], [PLC COM. ERROR], have also occurred, try to correct those problems also.

▼ **Reference** ▲ *7.4.1 Error Message List*

If the above mentioned methods do not solve the problem, please contact your local GP distributor.

## Chapter 7 - RUN Mode and Errors

### ◆ When the GP changes to OFFLINE mode during RUN mode

When the GP changes to OFFLINE mode without the user first pressing the screen, there is a possibility that the screen data has been damaged. In this case, after the SYSTEM ERROR displays, the screen automatically reverts to OFFLINE mode after about 10 seconds. Run the INITIALIZE MEMORY command and transfer the GP screen data again from your PC.

In most cases, system errors are related to the problems mentioned below.

#### • Environment Related Problems

If an error occurs which has no apparent connection to the GP's current operation, the error may be due to the condition of GP's operating environment. This can include noise or electrostatic interference in the power code or the communication line. In this case you need to check if the power code and the communication line wiring and FG grounding are correct.

#### • Screen Data or Project Data Related Problems

If an error seems to be caused by a particular GP operation, the error may be related to the screen or project data transferred to the GP. In this case, try sending screen data via the FORCE SYSTEM SETUP feature, which will transfer both the screen data and the project data to the GP.

**Reference** *For details about the FORCE SYSTEM SETUP feature, refer to GP-PRO/PBIII for Windows Operation Manual, Transfer Settings section.*

#### • GP Unit Related Problems

If disconnecting and then reconnecting the power code corrects an error, the problem may not be related to the GP unit itself. However, to identify if the GP unit has any problems, run the OFFLINE mode's SELF-DIAGNOSIS program.

#### • Peripheral Equipment Related Problems

##### (When the GP is equipped with a printer I/F)

If an error occurs only during printout, there may be a problem with the printer. Check the printer cable wiring and the FG line as well as the printer itself.

#### • When a communication error occurs continuously

##### (When using the Direct Access method)

If a communication error occurs continuously, the GP may define the error as a system error. In this case you need to solve the problem causing the original communication error.

## Chapter 7 - RUN Mode and Errors

### 7.5.2 Illegal Address in Screen Data

Caused by an overlap of addresses.

After the error message, error codes, as listed below, will appear. If the error cannot be fixed, please report the error code and details on how the error developed to your local GP distributor.

ILLEGAL ADDRESS IN SCREEN AREA (00B:XXX:XXX)

#### ◆ Overlapping Addresses

Error 1	Error 2	Meaning
0C1	191	All or part of the T-tag <sup>*1</sup> or S-tag address range overlap the addresses of System Data Area.
	192	
	193	
0C2	194	All or part of the System Data Area address, A-tag, or S-tag address range overlap the addresses setup in a T-tag. <sup>*1</sup>
	195	
	196	
0C3	197	All or part of a T-tag <sup>*1</sup> , S-tag or K-tag address range overlap the address range set in an A-tag (Alarm Message.)
	198	
	199	
0C9	19B	All or part of a T-tag <sup>*1</sup> , S-tag or K-tag address range overlap the address range set in an A-tag (Log alarm.)



**Note:** Overlapping addresses, other than the ones mentioned above, can also cause the Illegal Address message.

E.g. When the starting address of the System Data Area is set to 100, and the tag below is setup:

Tag Name/ Part ID No.	Word Address	Tag Format
N1	99	BCD32

Starting from addresses 99, two(2) words are used, which causes it to overlap address 100.

<sup>\*1</sup> For details about the T-tag (trend graph) and A-tag (alarm messages),

**Reference** *GP-PRO/PBIII for Windows Tag Reference Manual (included with the screen creation software)*

## Chapter 7 - RUN Mode and Errors

### 7.5.3 PLC Com. Error

Appears when the address setup for tags exceeds the address range used in the host (PLC.) Check the Error Number that appears and use the following table to solve the problem.

#### PLC COM. ERROR ( 02 : x x )

— Error code (see the table below)

— Constant Value

Error #	Problem	Countermeasure
FC	The communication settings for this unit and the host do not match.	* For Memory Link type, check the data or settings the host sends. For the PLC communication, check the communication speed.
FB	The address set on a tag, the address used for storing data for Trend graph, or the address set by an alarm message is out of a set range. * Memory to Memory Link type. * Siemen's PLC Series.	* When using Memory Link type: Set the addresses within the set range of the System Data Area (0 to 2047), and re-send correct data. * When using a Toyoda Machine Works PLC: Set the addresses within the set range of the devices. * When using a Yaskawa PLC: Set the addresses within the set range of the devices.
FA	Address range error	Set the addresses within the allowable range.
53	When using a Matsushita Electronics PLC, and there are too many screen tags, the PLC will not receive data.	Decrease the number of tags on the screen.
51	The tag addresses, Trend graph data storage address, Alarm message Registry address, do not exist in the PLC's internal memory.	* When using a Fuji Electric PLC: Setup the addresses in a device range that exists.
Others	The Error code for each PLC can be found in the table on the last page of this chapter. Then, look up the Error Number in the indicated PLC manual. Or, report the Error Number to the PLC manufacturer.	



**Note:** In Hitachi's HIDIC H (HIZAC H) Series, the error code is divided into 2 bytes, whereas the GP Error Number is composed of 1 byte codes.

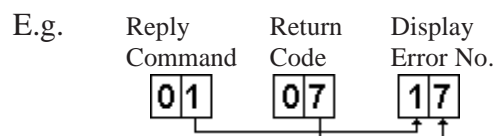

When the Display Error Number is 8\*, or 5\*, use only the left column as the error number.

## Chapter 7 - RUN Mode and Errors



- Note:**
- In Toshiba's PROSEC T Series, the Error Code is 4 characters long; on the GP, Error Numbers are changed to and displayed in Hexadecimal.
  - With the Allen-Bradley PLC-5 and SLC-500 Series, the EXT/STS error codes have been re-mapped to start at D0 HEX, so they will not conflict with other error codes. When looking up the error number in the PLC manual, subtract D0 h from the GP error code to find its error value.

E.g.	GP Error Code		PLC Error Code
	D1	—>	01
	EA	—>	1A

### 7.5.4 Clock Setup Error

This message displays when the lithium backup battery's voltage for the internal clock runs out. To reset the error, you need to turn the GP's power OFF and then ON again. Leave the GP ON continuously and the battery's charge will become sufficient for backup after 24 hours, and will be fully charged in approximately 96 hours. If the battery is incorrectly replaced, the battery may explode. To avoid the danger, please do not replace the battery yourself. When the battery needs a replacement, please consult with your local GP distributor.

After changing the backup battery, set up the internal clock.

**Reference** Chapter 6 - Initializing the GP

The lifetime of the backup battery depends on the ambient temperature and the amount of current being charged and used. The table below gives a general indication of how long the battery will last.

<b>Battery Temperature</b>	40°C or lower	50°C or lower	60°C or lower
<b>Expected Lifetime</b>	10 years or longer	4.1 years or longer	1.5 years or longer

### 7.5.5 Screen Tag Limit Exceeded (max. of 384)

When tags are setup beyond the tag limit, all tags in excess of number 384 will be disabled. Plus, when tags involve registered Windows and loaded screens, they are disabled in this order: Window Registry, Load Screen.

1. Disabled registered windows start from the last screen used.
2. Disabled loaded screens start from the last screen used.

To correct this problem, reduce the number of tags to within the allowed limit.

### 7.5.6 OBJ. PLC Has Not Been Setup

The host PLC setup in the Editor program (i.e. the .prw file) does not match the PLC in use. Use the Error Code that follows the error message to select the proper PLC type and correct the GP's INITIALIZE setup data so that it matches this.

OBJ. PLC HAS NOT BEEN SETUP ( X X )

|  
 The PLC number (*Hexadecimal*)  
 written to the GP's System File

### 7.5.7 D-Script and Global D-Script Errors

---

The following error messages are displayed when D-Scripts and Global D-Scripts are not configured properly. The GP-2300/2301 Series unit displays the error message on the bottom at the GP screen.

	Error Message
D-Script	D-Script Error (***)
Global D-Script	Global D-Script Error (***)

The following table lists the numbers assigned to (\*\*\*) in the above error messages. Error Nos. "001" and "002" are displayed at power-on, and Error Nos. "003" and "004" are displayed when an error occurs during the function processing.

No.	Description	Applicable Script
001	The total number of Global D-Scripts exceeds the limit. The maximum number of Global D-Scripts is 32. Note that functions are included in the counts.	Global D-Script
002	The total of all devices in the Global D-Script exceeds the limit of 255 devices.	Global D-Script
003	Either the function being called does not exist, or that function has caused an error.	D-Script Global D-Script
004	Function cannot be nested more than 10 levels.	D-Script Global D-Script



## Chapter 7 - RUN Mode and Errors

### 7.5.8 Extended SIO Script Error

---

The following error message is displayed when an Extended SIO Script is not configured properly. The GP-2300/2301 Series unit displays the error message on the bottom at the GP screen.

	Error Message
Extended SIO Script	Extended SIO Script Error (***)

The following table lists the numbers assigned to (\*\*\*) in the above error message. Error No. 001 is displayed at power-on, and Error Nos. 003 and 004 are displayed when an error occurs during the function processing.

No.	Description
001	The total number of the Functions of Extended SIO Scripts exceeds the limit. The maximum number of Functions of Extended SIO Scripts is 254.
002	Reserved
003	The function that is being called does not exist.
004	Functions cannot be nested more than 10 levels.
005	An old Extended SIO Script protocol is being used for the GP system. Extended SIO Script cannot be run when this error occurs. Be sure to install and run a new Extended SIO protocol (Version 1.12 or later).
006	An incompatible function was found in the screen data's Extended SIO Script. Be sure to install and run a new GP system.

# Chapter 8 Maintenance

1. Regular Cleaning
2. Periodic Check Points
3. Replacing the Backlight

## 8.1 Regular Cleaning

---

### 8.1.1 Cleaning the Display

---

When the surface or the frame of the display gets dirty, soak a soft cloth in water with a neutral detergent, wring the cloth tightly, and wipe the display.



- ***Do not use paint thinner, organic solvents, or a strong acid compound to clean the unit.***
- ***Do not use hard or pointed objects to operate the touch-screen panel, since it can damage the panel surface.***

### 8.1.2 Installation Gasket Check/Replacement

---

The installation gasket protects the GP and improves its water resistance. For instructions on installing the GP's gasket, refer to

**Reference**  *Chapter 3 "Installation and Wiring"*



***A gasket which has been used for a long period of time may have scratches or dirt on it, and could have lost much of its water resistance. Be sure to change the gasket at least once a year, or when scratches or dirt become visible.***

#### ■ Installation Gasket Replacement Procedure

1) Place the GP on a flat, level surface with the display facing downwards.

2) Remove the old gasket from the GP.

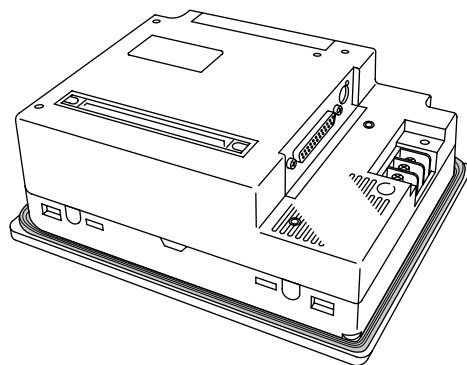

## Chapter 8 - Maintenance

- 3) Attach the new gasket to the GP.  
Be sure to insert the gasket into the GP's groove so that the gasket's groove sides are vertical.

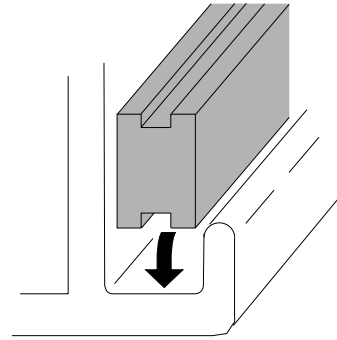

- 4) Check if the gasket is attached to the GP correctly.



- ***The gasket must be inserted correctly into the groove for the GP's moisture resistance to be equivalent to IP65f.***
- ***Be sure the gasket's seam is not inserted into any of the unit's corners, only in the straight sections of the groove. Inserting it into a corner may lead to its eventually tearing.***
- ***The upper surface of the gasket should protrude approximately 2mm out from the groove. Be sure to check that the gasket is correctly inserted before installing the GP into a panel.***

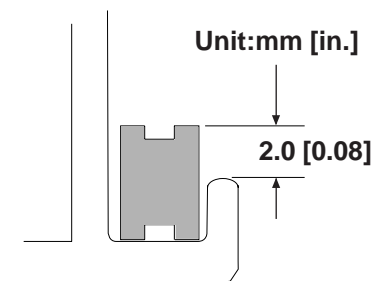
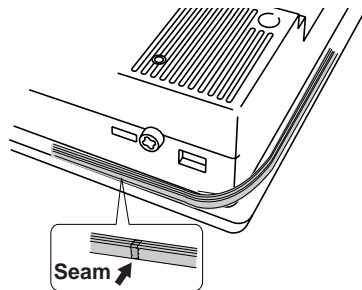

## 8.2 Periodic Check Points

---

To keep your GP unit in its best condition, please inspect the following points periodically.

### **GP Operation Environment**

- Is the operating temperature within the allowable range (0°C to 50°C )?
- Is the operating humidity within the specified range (10%RH to 90%RH, dry bulb temperature of 39°C or less)?
- Is the operating atmosphere free of corrosive gasses?

### **Electrical Specifications**

- Is the input voltage appropriate?  
DC19.2V to DC28.8V

### **Related Items**

- Are all power cords and cables connected properly? Have any become loose?
- Are all mounting brackets holding the unit securely?
- Are there many scratches or traces of dirt on the installation gasket?

## 8.3 Replacing the Backlight

When the unit's backlight burns out, the unit's status LED will turn orange. If the OFFLINE menu's "USE TOUCHPANEL AFTER BACKLIGHT BURNS OUT" feature is set to "NO", the GP's touch panel will be disabled. \*1

**Reference** 6.4.3 Set up Touch panel

The GP-2300 and GP-2301 Series units use a CCFL, long-life type backlight. The actual life of the backlight however, will vary depending on the GP's operating conditions, and replacement may be required. A GP2000 Series backlight has a life of 50,000 hours (approx. 5.7 years, at 25°C and 24 hour operation), when the backlight is lit continuously (time required for brightness to fall to half its normal level.)



### WARNINGS

- To prevent an electric shock, be sure the GP's power cord is unplugged from the power outlet prior to replacing the backlight.
- When the power has just been turned OFF, the unit and backlight are still very hot. Be sure to use gloves to prevent burns.
- The backlight is very fragile. Do not touch the glass tube directly or try to remove its power cord. If the glass tube breaks you may be injured.



**Note:** Use the following table to check that you have ordered the correct backlight.

GP Model	Backlight Model
GP2300-LG41-24V GP2300-SC41-24V GP2301-LG41-24V GP2301-SC41-24V	PS300-BU00

For backlight replacement details, refer to the replacement backlight unit's installation guide.



**The GP-2300T/GP-2301T's backlights cannot be replaced by the customer.**

**When the backlights need to be replaced, please contact your local GP distributor.**

\*1 If "NO" has been selected for the OFFLINE menu's "FORCE RESET" feature, Touch-Panel operation is disabled.

**Reference** 6.4.3 Set up Touch panel

# Index

## Symbols

2 Port Adapter II Cable .....	1-2, 1-4
2-Dimensional-Code Reader .....	1-2

## A

Accessories .....	1-8
After Connecting the Power Cord .....	7-1
Air Purity .....	2-2
Allowable Voltage Drop .....	2-2
Ambient Humidity .....	2-2
Ambient Operating Temperature .....	2-2
Application .....	2-4
Atmospheric .....	2-2
Atmospheric Endurance .....	2-2

## B

Backlight .....	2-3
Bar-Code Reader .....	1-2, 1-4
Brightness Adjustment .....	2-3
Buzzer Sounds when GP power is turned ON .	7-14

## C

CE Marking Notes .....	14
CF Card .....	1-2, 1-4, 7-5
CF Card Access Lamp .....	2-9
CF Card Checksum .....	7-6
CF Card Cover .....	2-10
CF card Handling .....	3-13
CF Card Installation and Removal .....	3-11
CF Card Memory Loader File Check .....	7-6
CF Card Slot .....	2-10
CF Memory Loader Tool .....	4-7
Character String Data Mode .....	6-7
Character String Data Setup .....	6-7
Checking the IP Address .....	4-6
Cleaning the Display .....	8-1
Clock .....	2-4
Clock Settings Cannot be Entered .....	7-7, 7-15
Clock Setup Error .....	7-22
Colors .....	2-3
COMMUNICATION PORT SETUP .....	6-22
Communication Setup .....	6-12
Connecting the Power Supply .....	3-8
Connecting the Power Cord .....	3-6

Contrast Adjustment .....	6-14, 2-3
Cooling Method .....	2-2
CSV DATA INDEX .....	6-32
Customize Setup .....	6-26

## D

D-Script Error .....	7-23
Data Transfer Cable .....	1-2, 1-4
Dimensions .....	2-12
Display .....	2-3
Display Pattern .....	7-4
Display Setup .....	6-16
Display Sizes .....	2-3
Documentation Conventions .....	14
Dust .....	2-2

## E

Effective Display Area .....	2-3
Electrical .....	2-1
Electrostatic Discharge Immunity .....	2-2
Environmental .....	2-2
EPSON PM Series / EPSON Stylus Series .....	6-18
Error Message Details .....	7-18
Error Messages .....	7-16
Error Screens .....	7-15
Essential Safety Precautions .....	6
Ethernet Cable Connector .....	3-10
Ethernet Data Transfer .....	4-4
Ethernet Interface .....	2-11
Ethernet Setup .....	6-28
Expansion Serial Environment Setup .....	6-20
Expansion Serial Interface .....	2-7, 2-11, 7-6
Expansion Serial Setup .....	6-19
Expansion Unit I/F .....	2-9
Extended SIO Script Error .....	7-24
External Dimensions .....	2-2

## F

Font Setting .....	6-2, 6-35
Font Sizes .....	2-3
Frame Buffer .....	7-4
FUNCTION SETUP .....	6-22
Functional Specifications .....	2-3

# Index

## G

General Safety Precautions .....	10
General Specifications .....	2-1
Global D-Script Error .....	7-23
Global Window Setup .....	6-6
GP .....	1
GP Edit Mode Peripherals .....	1-3, 1-5
GP Operation Altitude .....	2-2
GP RUN Mode Peripherals .....	1-2, 1-4
GP Screen Editor .....	14
GP-2300 Series System Design .....	1-2
GP-2300L .....	12
GP-2300S .....	12
GP-2300T .....	12
GP-2301 Series System Design .....	1-4
GP-2301L .....	12
GP-2301S .....	12
GP-2301T .....	12
GP2300/2301 Series Model Names .....	12
Grounding .....	2-2, 3-9
Grounding the GP .....	3-13

## I

I/O Signal Line Placement .....	3-9
Illegal Address in Screen Data .....	7-20
In-Rush Current .....	2-2
Initial Start Mode .....	4-2, 4-4
Initialization .....	5-4, 6-1
Initialization Items .....	6-2
Initialize CF Card .....	6-31
Initialize GP Memory .....	6-31
Initialize Memory .....	6-2
Input Port .....	7-5
Input Voltage .....	2-2
Installation Fasteners .....	2-14
Installation Gasket .....	3-1, 8-1
Installation Procedures .....	3-1
Installing the GP .....	3-4
Insulation Resistance .....	2-2
Interfaces .....	2-5
Internal FEPRM Checksum (System + Protocol) .....	7-4
Introduction .....	1-1

## L

Language Fonts .....	2-3
Location .....	6-6

## M

Maintenance .....	8-1
Memory .....	2-4
Menu Bar .....	6-13

## N

n:1 .....	6-1
No Display .....	7-8
No GP/Host Communication .....	7-11
Noise Immunity .....	2-2

## O

OBJ. PLC Has Not Been Setup .....	7-22
OFFLINE Mode .....	5-1
OFFLINE Mode Main Menu .....	5-3
Others Setup .....	6-30

## P

Package Contents .....	12, 14
Panel Cut .....	3-2
Panel Cut Dimensions .....	2-13
Part Names .....	2-9
Periodic Check Points .....	8-3
PLC .....	14
PLC Com. Error .....	7-21
PLC Setup .....	6-2, 6-23, 6-31
Pollution Degree .....	2-2
Possible Types of Trouble .....	7-7
Power Consumption .....	2-2
Power Input Terminal Block .....	2-9
Printer Cable .....	1-2
Printer Interface .....	2-8, 2-11, 7-6
Prior to Operating the GP .....	1-1

## R

Rated Voltage .....	2-2
Ratings .....	2-2
Replacing the Backlight .....	8-4
Resolution .....	2-3
Revision Information .....	14
RS-232C Cable .....	1-2, 1-4
RS-422 Cable .....	1-2, 1-4
RS-422 Connector Terminal Adapter .....	1-2, 1-4
RUN Mode .....	7-1

**S**

Screen Tag Limit Exceeded .....	7-22
Self-Diagnosis .....	5-6, 6-30, 7-3
Self-Diagnosis Item List .....	7-3
Serial Data Transfer .....	4-1
Serial Interfaces .....	2-6, 2-11
Set Up Capture Operation .....	6-21
Set Up I/O .....	6-2, 6-10
Set Up Operation Surroundings .....	6-23
Set Up Printer .....	6-17
Set Up Screen .....	6-2, 6-34
Set Up SIO .....	6-10
Set Up Time .....	6-2, 6-33
Set Up Touch Panel .....	6-13
SIO Check .....	7-5
Specifications .....	2-1
Stand-By Mode Time .....	6-3
Station Setup .....	6-24
Status LED .....	2-9
Stop Bit .....	6-10, 6-19
Storage Temperature .....	2-2
Structural .....	2-2
SYSLOG Setup .....	6-29
System Area Setup .....	6-4
System Design .....	1-2
System Environment Setup .....	6-2, 6-3
System Errors .....	7-18
System Setup .....	6-3

**T**

Table of Contents .....	2
Text .....	2-3
Tool Connector .....	2-11, 3-10
Tool Connector Loop Back .....	7-5
Touch Panel .....	2-9, 7-4
Touch Panel Does Not Respond .....	7-13, 7-15
Troubleshooting .....	7-7
Type .....	2-3

**U**

UL/c-UL (CSA) Application Notes .....	13
Use Touch Panel After Backlight Burnout .....	6-15

**V**

Via OFFLINE Mode .....	7-2
Vibration Resistance .....	2-2
Voltage Endurance .....	2-2

**W**

Weight .....	2-2
Wiring .....	3-1
Wiring Precautions .....	3-6



# *Memo*