

SIEMENS

SIMATIC

ET 200S distributed I/O IM151-1 FO STANDARD interface module (6ES7151-1AB05-0AB0)

Manual

Preface

Properties

1

Parameters

2

Functions

3

Error and system messages

4

Response times

5

Order numbers

A

Legal information

Warning notice system

This manual contains notices you have to observe in order to ensure your personal safety, as well as to prevent damage to property. The notices referring to your personal safety are highlighted in the manual by a safety alert symbol, notices referring only to property damage have no safety alert symbol. These notices shown below are graded according to the degree of danger.

⚠ DANGER
indicates that death or severe personal injury will result if proper precautions are not taken.
⚠ WARNING
indicates that death or severe personal injury may result if proper precautions are not taken.
⚠ CAUTION
with a safety alert symbol, indicates that minor personal injury can result if proper precautions are not taken.
CAUTION
without a safety alert symbol, indicates that property damage can result if proper precautions are not taken.
NOTICE
indicates that an unintended result or situation can occur if the corresponding information is not taken into account.

If more than one degree of danger is present, the warning notice representing the highest degree of danger will be used. A notice warning of injury to persons with a safety alert symbol may also include a warning relating to property damage.

Qualified Personnel

The product/system described in this documentation may be operated only by **personnel qualified** for the specific task in accordance with the relevant documentation for the specific task, in particular its warning notices and safety instructions. Qualified personnel are those who, based on their training and experience, are capable of identifying risks and avoiding potential hazards when working with these products/systems.

Proper use of Siemens products

Note the following:

⚠ WARNING
Siemens products may only be used for the applications described in the catalog and in the relevant technical documentation. If products and components from other manufacturers are used, these must be recommended or approved by Siemens. Proper transport, storage, installation, assembly, commissioning, operation and maintenance are required to ensure that the products operate safely and without any problems. The permissible ambient conditions must be adhered to. The information in the relevant documentation must be observed.

Trademarks

All names identified by ® are registered trademarks of the Siemens AG. The remaining trademarks in this publication may be trademarks whose use by third parties for their own purposes could violate the rights of the owner.

Disclaimer of Liability

We have reviewed the contents of this publication to ensure consistency with the hardware and software described. Since variance cannot be precluded entirely, we cannot guarantee full consistency. However, the information in this publication is reviewed regularly and any necessary corrections are included in subsequent editions.

(A)

가

Preface

Purpose of the manual

This manual supplements the *ET 200S Distributed I/O System* Operating Instructions. General functions for the ET 200S are described in the ET 200S Distributed I/O System Operating Instructions (<http://support.automation.siemens.com/WW/view/en/1144348>).

The information in this document along with the operating instructions enables you to commission the ET 200S.

Basic knowledge requirements

To understand these operating instructions you should have general knowledge of automation engineering.

Scope of the manual

This manual applies to this ET 200S module. It describes the components that are valid at the time of publication.

Recycling and disposal

Thanks to the fact that it is low in contaminants, this ET 200S module is recyclable. For environmentally compliant recycling and disposal of your electronic waste, please contact a company certified for the disposal of electronic waste.

Additional support

If you have any questions relating to the products described in this manual and do not find the answers in this document, please contact your local Siemens representative (<http://www.siemens.com/automation/partners>).

A guide to the technical documentation for the various SIMATIC products and systems is available on the Internet. (<http://www.siemens.com/simatic-docu>).

The online catalog and ordering systems are available on the Internet (<http://www.siemens.com/automation/mall>).

Training center

We offer courses to help you get started with the ET 200S and the SIMATIC S7 automation system. Please contact your regional training center or the central training center in D - 90327, Nuremberg, Germany (<http://www.siemens.com/sitrain>).

Technical Support

You can contact Technical Support for all Industry Automation products by means of the Internet Web form for the Support Request (http://www.siemens.com/automation/csi_en_WW/support_request).

Additional information about Siemens Technical Support is available on the Internet (http://www.siemens.com/automation/csi_en_WW/service).

Service & Support on the Internet

In addition to our documentation, we offer a comprehensive knowledge base on the Internet (http://www.siemens.com/automation/csi_en_WW/support).

There you will find:

- Our Newsletter, which constantly provides you with the latest information about your products.
- The right documentation for you using our Service & Support search engine.
- The bulletin board, a worldwide knowledge exchange for users and experts.
- Your local contact for Automation & Drives in our contact database.
- Information about on-site services, repairs, spare parts, and lots more.

Table of contents

	Preface	3
1	Properties	7
2	Parameters	11
2.1	Parameters for the IM151-1 FO STANDARD interface module	11
2.2	Parameter description	12
2.2.1	DP interrupt mode	12
2.2.2	Bus length	12
2.2.3	Enable startup for set <> actual configuration	12
2.2.4	Option handling in general	12
2.2.5	Option handling: Slot 2 to 63 (with RESERVE module)	13
2.2.6	Diagnostic interrupt	13
2.2.7	Process interrupt	13
2.2.8	Insert/remove-module interrupt	13
2.2.9	Analog-value format	13
2.2.10	Interference frequency suppression	13
2.2.11	Reference junction slot	14
2.2.12	Reference junction input	14
3	Functions	15
3.1	Option handling with RESERVE modules	15
3.1.1	Principle of operation of option handling with RESERVE modules	15
3.1.2	Prerequisites for option handling with RESERVE modules	16
3.1.3	Example for using RESERVE modules	17
3.1.4	Assigning parameters for option handling with RESERVE modules	18
3.1.5	Controlling and monitoring options with RESERVE modules	19
3.1.6	Troubleshooting for option handling with RESERVE modules	21
3.1.7	Address area for option handling and status byte with RESERVE modules	21
3.2	Option handling without RESERVE modules	23
3.2.1	Principle of operation of option handling without RESERVE modules	23
3.2.2	Prerequisites for option handling without RESERVE modules	24
3.2.3	Example for use without RESERVE modules	25
3.2.4	Configuring option handling without RESERVE modules	26
3.2.5	Controlling and monitoring options without RESERVE modules	27
3.3	Identification data	29

4	Error and system messages	33
4.1	LED displays on the interface module	33
4.2	Process interrupt lost	38
4.3	Diagnostic messages of the electronic modules.....	38
4.4	Diagnostics with STEP 7	39
4.4.1	Diagnostics readout	39
4.4.2	Structure of the slave diagnostics	41
4.4.3	Station statuses 1 to 3	42
4.4.4	Master PROFIBUS address.....	43
4.4.5	Identifier-related diagnostics.....	44
4.4.6	Module status.....	45
4.4.7	Channel-specific diagnostics	46
4.4.8	Interrupts.....	47
4.4.9	Incorrect module configurations of ET 200S on the PROFIBUS DP.....	55
4.4.10	DP slave failure.....	56
4.5	Evaluating the interrupts of the ET 200S.....	56
5	Response times.....	61
5.1	Overview	61
5.2	Response times for the ET 200S.....	62
5.3	Response time for digital input modules.....	63
5.4	Response time for digital output modules.....	63
5.5	Response time for analog input modules	64
5.6	Reaction times of analog output modules.....	65
5.7	Response times for a 4 IQ-SENSE electronic module	66
5.8	Response times for technology modules.....	66
A	Order numbers	67
	Index.....	69

Properties

Properties

The IM151-1 FO STANDARD interface module has the following features:

- It connects the ET 200S with PROFIBUS DP via the fiber-optic interface.
- Connectable fiber optic cables made from plastic optical fibers (POF) or plastic-coated fibers (PCF)
- On SIMATIC S7 (in DPV1 mode), the maximum parameter length is 240 bytes per slot.
- The maximum address space is 244 bytes for inputs and 244 bytes for outputs.
- Operation as a DPV0 or DPV1 slave
- A maximum of 63 modules can be operated with the IM151-1 FO STANDARD.
- The maximum bus length is 2 m.
- It supports option handling and the status byte for power modules.
- Firmware update over PROFIBUS DP with STEP 7
- Identification data (with DS248 or DS255)
- Direct data exchange (publisher)

The IM151-1 FO STANDARD interface module (6ES7151-1AB05-0AB0) replaces the predecessor interface modules 6ES7151-1AB02-0AB0.

Installation constraints

For every 2DO 24 to 230 V AC electronic module used, the number of connectable I/O modules in this station is reduced by one.

Terminal assignment

The following table shows the terminal assignment of the IM151-1 FO STANDARD interface module for the 24 VDC voltage supply and PROFIBUS DP with fiber-optic interface:

Table 1- 1 Terminal assignment of the IM151-1 FO STANDARD interface module

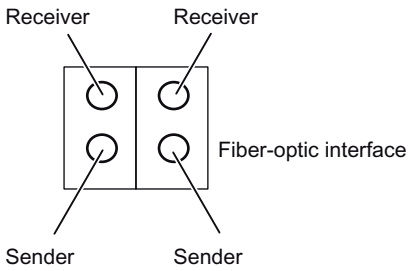
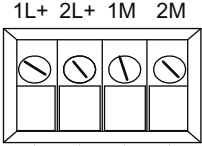
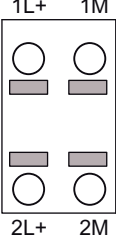
View	Signal name	Name
		
<p>to 6ES7151-1AB02-0AB0</p>  <p>as of 6ES7151-1AB05-0AB0</p> 	<p>1 L+</p> <p>2 L+</p> <p>1 M</p> <p>2 M</p>	<p>24 VDC</p> <p>(for loop through)</p> <p>Chassis ground</p> <p>(for loop through)</p>

Block diagram

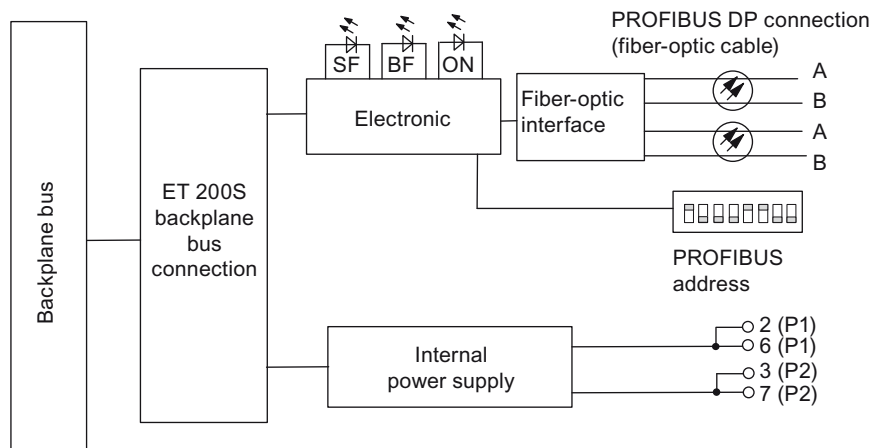

Figure 1-1 Block diagram for the IM151-1 FO STANDARD interface module

Technical data for IM151-1 FO STANDARD (6ES7151-1AB05-0AB0)

Dimensions and weight	
Dimension B (mm)	45
Weight	Approx. 150 g
Module-specific data	
Data transmission rate	9.6; 19.2; 45.45; 93.75; 187.5; 500 kBaud, 1.5; 12 Mbit/s
Bus protocol	PROFIBUS DP
Interface	Fiber-optic cable
SYNC capability	yes
FREEZE capability	yes
Manufacturer ID	806BH
Direct data exchange	yes
Cycle synchronization	No
Parameter length	27 bytes
Address space	244 bytes I/O
Option handling	
• With reserve module	Yes
• Without reserve module	yes
I&M data	yes
Firmware update	via PROFIBUS DP with STEP7
Voltages, currents, potentials	
Rated supply voltage of the electronic components (1L+)	24 VDC
• Incorrect polarity protection	yes
• Power failure bypass	Min. 20 ms
Galvanic isolation	
• Between the backplane bus and electronic components	No
• Between the supply voltage and electronic components	No
Permitted potential difference (to the rail)	75 V DC, 60 V AC
Insulation tested with	500 VDC
Current consumption from rated supply voltage (1L+)	Approx. 200 mA
Power dissipation of the module	Typically 3.3 W
Status, interrupts, diagnostics	
Interrupts	yes
Diagnostic function	yes
• Group error	Red "SF" LED
• PROFIBUS DP bus monitoring	Red "BF" LED
• Monitoring of the power supply voltage of the electronics	Green "ON" LED

Acyclic data traffic class 2 services (PG/OP)

The interface module IM 151-1 FO STANDARD supports 3 connections via class 2 services (PG/ OP).

Updating the firmware of the IM151-1 FO STANDARD

The IM151-1 FO STANDARD firmware can be updated starting with *STEP 7*V5.4 (via accessible nodes).

To update the firmware, you receive the *.UPD files containing the current firmware.

The following requirements must be satisfied:

- The IM151-1 FO STANDARD in the station whose firmware is to be updated must be accessible online.
- The files with the current firmware version must be available in the file system of your programming device or PC.

Information regarding the method of procedure can be found in the *STEP 7* online help.

Note

Make sure to use the correct firmware version for the interface module in use during the update process. An interface module with an older order number cannot be updated with the firmware version for an interface module with a more recent order number and vice versa.

Configuration with more than 244 bytes of parameter data

For configurations with *STEP 7*V5.4, it is possible to operate the IM151-1 FO STANDARD from 6ES7151-1AB05-0AB0 in DPV1 mode with more than 244 bytes of parameter data. A configuration based on the GSD file does not offer this possibility.

Note

If the parameter length is greater than 244 bytes, an increase in the station startup time is to be expected.

Parameters

2.1 Parameters for the IM151-1 FO STANDARD interface module

Parameterize register

Table 2- 1 Parameters for the IM151-1 FO STANDARD interface module

IM151-1 FO STANDARD	Value range	Default setting ⁵	Applicability
DP interrupt mode	DPV0/DPV1	DPV0	ET 200S
Bus length	≤ 1 m / > 1 m	≤ 1 m	ET 200S
Operation at set < > actual configuration ¹	disable/enable	Disable	ET 200S
Diagnostic interrupt ³	disable/enable	Disable	ET 200S
Process interrupt ³	disable/enable	Disable	ET 200S
Remove/insert module interrupt ^{2 3}	disable/enable	Disable	ET 200S
Identifier-related diagnostic data	disable/enable	Enable	ET 200S
Module status	disable/enable	Enable	ET 200S
Channel-specific diagnostics	disable/enable	Enable	ET 200S
Option handling in general	disable/enable	Disable	ET 200S
Option handling	with / without reserve module	with reserve module	ET 200S
Option handling: Slots 2 to 63	disable/enable	Disable	ET 200S
Analog value format ⁴	SIMATIC S7/ SIMATIC S5	S7	ET 200S
Interference frequency suppression	50 Hz / 60 Hz	50 Hz	ET 200S
Reference junction slot	None /2 to 63	None	ET 200S
Reference junction input	RTD on channel 0/ RTD on channel 1	0	ET 200S
¹ See also the "option handling" parameter. ² The default setting of the parameter in the GSD file is "disable". ³ Only parameterizable in DPV1 operation. ⁴ The parameter only exists when configuring via the GSD file. ⁵ The default settings apply to the default startup (if no other parameters have been assigned by the DP master).			

2.2 Parameter description

2.2.1 DP interrupt mode

This parameter can be used to enable or disable ET 200S DPV1 operation. Data records and interrupts (can be assigned parameters) are supported by class 1 and class 2 services after DPV1 mode is enabled.

Requirements:

- The DP master must also support DPV1.

2.2.2 Bus length

≤ 1 m: The default setting for the maximum bus length is 1 m.

> 1 m: The bus length of the ET 200S is > 1 m and can be up to 2 m. However, this setting will increase the response time of the ET 200S.

2.2.3 Enable startup for set <> actual configuration

When this parameter is enabled:

- Removing and inserting modules during operation will not lead to an ET 200S station failure.
- If the actual configuration differs from the expected configuration, data exchange between the ET 200S and the DP master will continue.

When this parameter is disabled:

- Removing and inserting modules during operation will lead to an ET 200S station failure.
- If the actual configuration differs from the expected configuration, data exchange between the ET 200S and the DP master will cease.
Exception: Option handling

2.2.4 Option handling in general

This parameter can be used as a general means of enabling or disabling option handling for the entire ET 200S.

2.2.5 Option handling: Slot 2 to 63 (with RESERVE module)

This parameter can be used to enable or disable checking of the configuration.

- Slots 2 to 63 are enabled: Instead of the configured electronic module you can also insert a RESERVE module into the relevant slot without generating a diagnostics message.
- Slots 2 to 63 are disabled: Only the configured module can be located on the relevant slot. RESERVE modules are treated as incorrect modules. Depending on the setting of the "Enable startup for set <> actual configuration" parameter, the ET 200S will either terminate or continue data exchange.

2.2.6 Diagnostic interrupt

This parameter can be used to enable or disable diagnostic interrupts. Diagnostic interrupts are supported

- on PROFIBUS DP, if the ET 200S is in DPV1 mode.

2.2.7 Process interrupt

This parameter can be used to enable or disable process interrupts. Process interrupts are supported.

- On PROFIBUS DP, if the ET 200S is in DPV1 mode.

2.2.8 Insert/remove-module interrupt

This parameter can be used to enable or disable remove/insert module interrupts. Remove/insert module interrupts are supported

- On PROFIBUS DP, if the ET 200S is in DPV1 mode.

2.2.9 Analog-value format

You set the number format for all analog electronic modules here.

2.2.10 Interference frequency suppression

The frequency of your AC power system can interfere with the measured value especially when measuring in low voltage ranges and using thermocouple elements. Enter the line frequency for your system here (50 Hz or 60 Hz).

The interference frequency suppression parameter applies to all analog electronic modules. This parameter is also used to specify the integration and conversion time of the various modules. See the technical data for the analog electronic modules.

2.2.11 Reference junction slot

This parameter can be used to assign a slot (none, 2 to 12/2 to 63) with a channel for measuring the reference temperature (calculation of the compensation value).

Reference

For information on connecting thermocouples, refer to the *manuals* for the *analog electronic modules*.

2.2.12 Reference junction input

This parameter can be used to set the channel (0/1) for measuring the reference temperature (calculation of the compensation value) for the assigned slot.

Reference

For information on connecting thermocouples, refer to the *manuals* for the *analog electronic modules*.

Functions

3.1 Option handling with RESERVE modules

3.1.1 Principle of operation of option handling with RESERVE modules

Principle

With option handling with RESERVE modules, the configuration of ET 200S Slots 2 to 63 is checked. If a slot is enabled for option handling, the RESERVE module (option) can occupy this slot instead of the configured electronic module without triggering a diagnostic interrupt. If the slot is disabled, only the configured electronic module can occupy this slot. Any other module will trigger a diagnosis. You can also control the configuration of Slots 2 to 63 and monitor the configuration of Slots 1 to 63 using the control and feedback interface in the process input image (PII) and process output image (PIQ).

The setting of the parameter "Operation at Preset <> Actual configuration" is not relevant for the process illustrated.

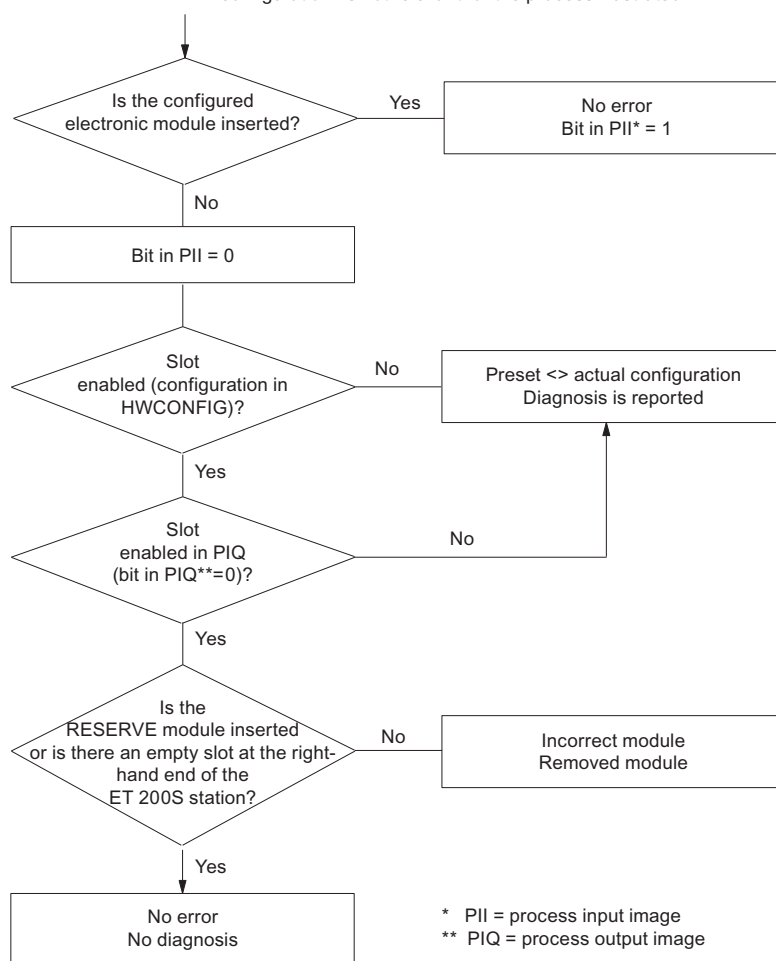

Figure 3-1 Principle of operation of option handling with RESERVE modules

3.1.2 Prerequisites for option handling with RESERVE modules

Requirements

For option handling with RESERVE modules you require:

- An interface module that supports option handling with a RESERVE module.
- A power module PM-E 24 to 48 V DC (6ES7138-4CB50-0AB0 and higher) or PM-E 24 to 48 V DC/24 to 230 V AC (6ES7138-4CB10-0AB0 and higher).

Note

One of these power modules must be included in the configuration at least once, together with one of the aforementioned interface modules.

- RESERVE modules as replacements for future electronic modules
- For configuration of the IM151-1 FO STANDARD
 - DPV0/DPV1 mode: As of 09/2009 (V1.0 or higher), GSD file SI04806B.GSx
 - DPV0 mode: GSD file SI02806B.GSx.

Note

In STEP 7, you do not require a GSD file for option handling with the:

- IM151-1 FO STANDARD as of STEP 7 V5.4.
- The current HW update for the interface and power modules. Use the menu command "Options > Install HW Updates" in HW Config to link the HW update. The HW updates can be downloaded from Customer Support on the Internet.

You can find the options handling description in the STEP 7 Online Help.

Note

If the actual configuration of an ET 200S station does not match the set configuration, a diagnostics report is generated if the check for the relevant slots is not enabled for option handling.

3.1.3 Example for using RESERVE modules

Configuration variants

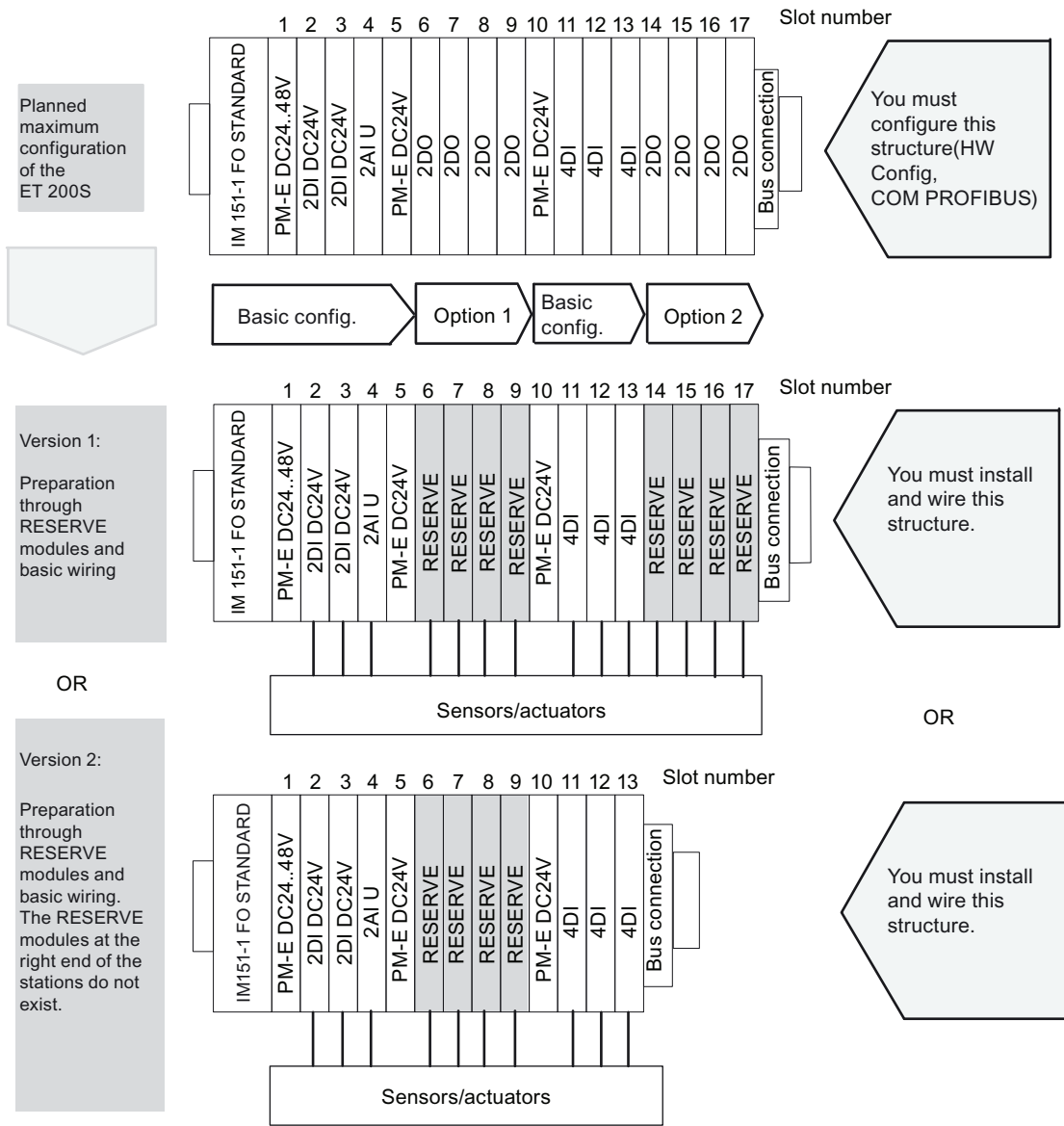

Figure 3-2 Example for using RESERVE modules

3.1.4 Assigning parameters for option handling with RESERVE modules

Introduction

In *STEP 7* or *COM PROFIBUS* you assign the parameters for the electronic modules which you want to use in future applications, e.g. 4DI H, on the RESERVE module slots (or the expansion modules on the right-hand end of the station):

- Drag the electronic module to the configuration table
- Assign the parameters

Procedure

1. Drag a PM-E 24..48 VDC or PM-E 24..48 VDC/24..230 VAC power module with one of the following entries into the configuration table:
 - ...O (option handling) or
 - ...SO (status byte + option handling)

Note

Entry of the power module with the ending ...O or ...SO can only be made **once** in the ET 200S configuration!

2. Assign parameters to the interface module as follows:

Interface module	Parameter	Setting	Description
IM151-1 STANDARD	Option handling, general	enable	Option handling is activated for the entire ET 200S.
<i>or</i> IM151-1 FO STANDARD	Option handling: Slots 2 to 63	Enable (all the slots where RESERVE modules can be located)	There are RESERVE modules or a configured electronic module on the slot. A diagnostic is not signaled.
<i>or</i> IM151-1 HIGH FEATURE	Option handling: With/without RESERVE modules	With RESERVE modules	Selects option handling with RESERVE modules

Note

If "Operation for set < > actual installation" is blocked for parameter assignment,

- the ET 200S does not start up if a module is missing or if an incorrect module is plugged in. The diagnostic "No module" or "Incorrect module" is signaled.
 - The ET 200S starts up if you enable option handling for the slot where a RESERVE module is plugged in. A diagnostic is not signaled.
-

Substitute values

If you have assigned an electronic module for the RESERVE module, the following substitute values are signaled:

- Digital input modules: 0
- Analog input modules: 7FFF_H
- Function module: 0

See also

Option handling in general (Page 12)

3.1.5 Controlling and monitoring options with RESERVE modules

Introduction

You can use the control interface (PIQ) and feedback interface (PII) to control and monitor options by means of the user program.

Recommendation: Before working with the ET 200S optional enhancements, check whether all the configured electronic modules are plugged in using the feedback interface (refer to the table below).

Note

SFCs 14/15 can be used to consistently access the control and feedback interface.

Principle

The control and feedback interface is located in the input and output process image of the PM-E DC24..48V, PM-E DC24..48V/AC24..230V and PM-E DC24V HF power modules. It can only be accessed if entries ending in ...O or ...SO for that power module were selected in the configuration software.

One bit is available for each ET 200S electronic or RESERVE module slot.

- Control interface: Slot 2 to 63
- Feedback interface: Slot 1 to 63

	7	6	5	4	3	2	1	0
EB/AB x	7	6	5	4	3	2	1	*
EB/AB x+1	15	14	13	12	11	10	9	8
EB/AB x+2	23	22	21	20	19	18	17	16
EB/AB x+3	31	30	29	28	27	26	25	24
EB/AB x+4	39	38	37	36	35	34	33	32
EB/AB x+5	47	46	45	44	43	42	41	40
EB/AB x+6	55	54	53	52	51	50	49	48
EB/AB x+7	63	62	61	60	59	58	57	56

Figure 3-3 Control (PIQ) and feedback interface (PII)

(*) irrelevant

Control interface PIQ (AB x to AB x+7):

You can use these bytes (8 bytes) to control the diagnostic behavior of the slots that you enabled for option handling in the HW Config.

Only the slot bits enabled at parameter assignment for option handling are evaluated. They are marked with "0".

Table 3- 1 Control interface

Slot	Value of the bit	Reaction
2 to 63	0	Parameter assignment for option handling applies. RESERVE modules are allowed: <ul style="list-style-type: none"> • The station is engaged in data exchange. • A diagnostic is not signaled. • The SF LED on the interface module is off.
	1	Parameter assignment for option handling is cancelled. RESERVE modules are not accepted on this slot: <ul style="list-style-type: none"> • The station is engaged in data exchange. • The diagnostic "Incorrect module" is signaled. • The SF LED on the interface module is on.

Feedback interface PII (EB x to EB x+7):

The feedback interface (8 bytes) tells you which module is actually located on which slot. All slots are reported. Even slots that were not enabled for option handling.

Table 3- 2 Feedback interface

Slot	Value of the bit	Reaction
0	0	Option handling is inactive
	1	Option handling is active
1 to 63	0	The RESERVE module, an incorrect module, or a removed module is on the slot.
	1	The configured module is on the slot.

3.1.6 Troubleshooting for option handling with RESERVE modules

Troubleshooting for option handling

Table 3- 3 Troubleshooting option handling

Event	Cause	Action
ET 200S does not start up; configuration error	There are multiple entries in the ET 200S configuration for power modules ending in ...O or ...SO.	Check and correct the configuration in HW Config.
	There are no entries of power modules ending in ...O or ...SO in the ET 200S configuration.	Use a power module entry ending in ...O or ...SO in HW Config.

3.1.7 Address area for option handling and status byte with RESERVE modules

Address area for option handling and status byte

You can control and monitor option handling and evaluate the status byte of the power module using the control (PIQ) and feedback (PII) interface.

The address range in the control (PIQ) and feedback interface (PII) depends on the configuration, i.e. the selection of the corresponding entry in the configuration software.

This table shows the PII feedback interface and the PIQ control interface for various entries.

Table 3- 4 PII feedback interface and PIQ control interface

In STEP 7/HW Config or COM PROFIBUS or other configuration software	Feedback interface PII		Control interface PIQ	
	Usual entry for the power module	---		---
Ends in ...S	lbx	Status byte	---	
Ends in ...O	lBx ... lBx+7	Option handling	OBx ... OBx+7	Option handling
Ends in ...SO	EBx ... EBx+7	Option handling	ABx ... ABx+7	Option handling
	lBx+8	Status byte	OBx+8	Not applicable

Option handling in PIO/PII

	7	6	5	4	3	2	1	0
AB/EB x	7	6	5	4	3	2	1	*
AB/EB x+1	15	14	13	12	11	10	9	8
AB/EB x+2	23	22	21	20	19	18	17	16
AB/EB x+3	31	30	29	28	27	26	25	24
AB/EB x+4	39	38	37	36	35	34	33	32
AB/EB x+5	47	46	45	44	43	42	41	40
AB/EB x+6	55	54	53	52	51	50	49	48
AB/EB x+7	63	62	61	60	59	58	57	56

(*) Not applicable

Figure 3-4 Option handling in PIQ/PII

PIO: OB x to OB x+7		
Slot 2 to 63:	0	Parameter assignment for option handling applies. RESERVE modules are allowed: <ul style="list-style-type: none"> The station is engaged in data exchange. A diagnostic is not signaled. The SF LED on the interface module is off.
	1	Parameter assignment for option handling is canceled. RESERVE modules are not accepted on this slot: <ul style="list-style-type: none"> The station is engaged in data exchange. A diagnostic is not signaled. The SF LED on the interface module is off.
PII: IB x to IB x+7		
Slot 1 to 63:	0	The RESERVE module, an incorrect module, or a removed module is on the slot.
	1	The configured module is on the slot.

3.2 Option handling without RESERVE modules

3.2.1 Principle of operation of option handling without RESERVE modules

Principle

In the case of option handling without RESERVE modules, the configuration data are insufficient to compare the preset configuration with the actual configuration. In addition, information about the existing options is still required. This information must be sent to the IM151-1 FO STANDARD via the user data. To receive the user data, the IM151-1 FO STANDARD initially goes formally into cyclic data exchange after the configuration data have been received. However, direct I/O access does not yet take place. Output data are rejected, the input data are zero. The IM151-1 FO STANDARD only responds to the output data that you have to connect to a power module (O or SO). A preset-actual test isn't possible until this option information is available. Only after this can the I/O devices be operated.

Because the option information is stored retentively in the IM151-1 FO STANDARD, this intermediate state only exists during the first commissioning or reconfiguration/retrofitting.

Please note the following:

- Data record requests to option slots that do not exist induce a fault (80B0).
- If the IM151-1 FO STANDARD is operated without configuration or without a CPU (DP master), it supplies the configuration as it exists. This is relevant for wiring test tools, since the actual slot numbers, without gaps from 1 to n, are used there for status/control.
- There are no limitations when "packing" digital modules. Theoretically, the module to which the byte address is assigned in the preset configuration can be missing in the structure.

Note

The configured slot numbers (slot numbers in data records, and for events such as diagnostics and interrupts) always apply for slot addressing.

3.2.2 Prerequisites for option handling without RESERVE modules

Prerequisites

For option handling without RESERVE modules you require:

- IM151-1 FO STANDARD interface module (as of 6ES7151-1AB05-0AB0)
- Power module PM-E DC24..48V, PM-EDC24..48V/AC24..230V or PM-E DC24V HF
One of these power modules must be included in the configuration at least once.
- For configuring the GSD file SI04806B.GSx as of 09/2009.

Note

You do not require a GSD file for option handling in *STEP 7* as from:

- STEP 7 V5.4 with HSP2057

You can find the description for option handling in the STEP 7 Online Help.

3.2.3 Example for use without RESERVE modules

Configuration variants

Below is an example of the use of option handling without RESERVE modules.

Note: A "0" in the control interface means that this slot number is deactivated in the configuration and thus does not exist.

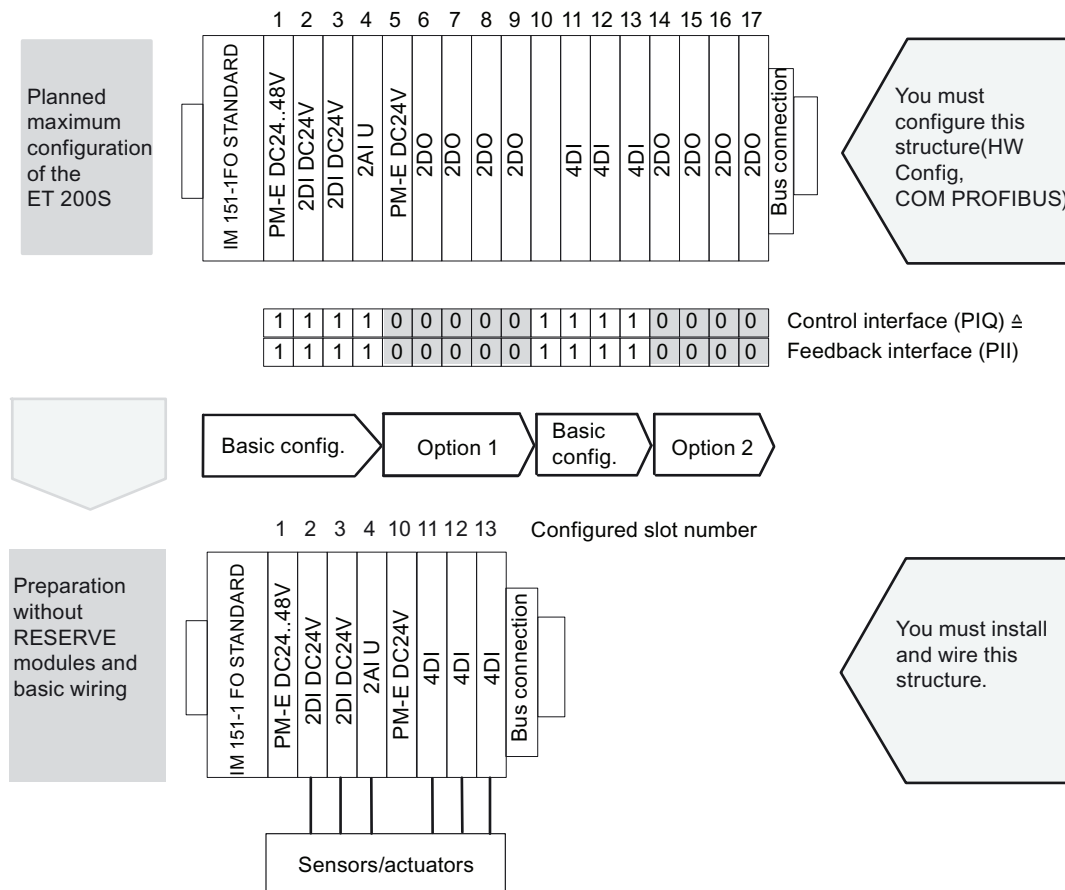

Figure 3-5 Example for use without RESERVE modules

3.2.4 Configuring option handling without RESERVE modules

Introduction

You configure option handling without RESERVE modules as described below.

Procedure

1. Drag a PM-E DC24..48V, PM-E DC24..48V/AC24..230V or PM-E DC24V HF power module with one of the following entries into the configuration table:
 - ...O (option handling) or
 - ...SO (status byte + option handling)

Note

You may only enter the power module with the ending ...O or ...SO **once** in the ET 200S configuration! We recommend configuring the power module to slot 1.

2. Assign parameters to the interface module as follows:

Interface module	Parameter	Setting	Description
IM151-1 FO STANDARD (as of 6ES7151-1AB05-0AB0)	Option handling, general	Enable	Option handling is activated for the entire ET 200S.
	Option handling: With/without RESERVE modules	Without RESERVE modules	Selects option handling without RESERVE modules

Note

If "Operation for set < > actual installation" is blocked for parameter assignment, the ET 200S does not start up if a module is missing or if an incorrect module is plugged in (see LED display of the configuration and parameter assignment errors (Page 33)). If an incorrect module is inserted, then the ET 200S will function but the I/O will not be enabled.

The diagnostic "No module" or "Incorrect module" is signaled.

If the IM151-1 FO STANDARD does not start up in this state, the SF LED lights up at the interface module and at the deactivated electronic module of the ET 200S.

Note

In the case of option handling without RESERVE modules, incorrect filling in of the control interface can result in too many plugged modules with a slot number greater than 63 are reported from the point of view of the interface module. Since there is only room for 63 modules in the diagnostics message (module status), the highest-value bit is set in the "Identifier-related diagnostics" in this case. This produces the following results:

- The SF LED on the IM lights up
 - Bit 3 in status byte 1 of the diagnostics message is set (external diagnosis exists)
 - The "Slot 64 faulty" error message is indicated in STEP7.
-

Behavior during the first start-up

In the case of option handling without RESERVE modules, the IM151-1 FO STANDARD always goes into cyclic data exchange during initial startup. However, the I/O device input/output is not activated until valid information about the options is available from the module. No fault is indicated externally in this state (BF LED does not light up). The input/output of the I/O devices is not active in this state. Evaluate the data of the feedback interface in order to assess this state.

Behavior during a warm restart

Valid information about the options is stored retentively in the IM151-1. During warm restart, the IM151-1FO STANDARD enters cyclic data exchange and the input/output of the I/O devices is activated immediately. Has the configuration changed since the last startup (e.g.: incorrect module plugged in or information about options is incorrect), the input/output of the I/O devices is deactivated (irrespective of the parameter "Mode with set <> actual setup") until the real configuration agrees again with the configured one.

3.2.5 Controlling and monitoring options without RESERVE modules

Introduction

You can use the control interface (PIQ) and feedback interface (PII) to control and monitor options by means of the user program.

Recommendation: Before working with the ET 200S optional enhancements, check whether all the required electronic modules are plugged in using the feedback interface (refer to the table below). The contents of the feedback interface have to agree with the specifications of the control interface.

Note

The use of SFCs 14/15 enables consistent access to the control and feedback interface.

Principle

The control and feedback interface is located in the input and output process image of the PM-E 24..48 VDC or PM-E 24..48 VDC/24..230 VAC power modules. It can only be accessed if entries ending in ...O or ...SO for that power module were selected in the configuration software.

One bit is available for each ET 200S electronic module slot:

- Control interface: Slots 1 to 63
- Feedback interface: Slots 1 to 63

	7	6	5	4	3	2	1	0
EB/AB x	7	6	5	4	3	2	1	0
EB/AB x+1	15	14	13	12	11	10	9	8
EB/AB x+2	-	-	-	-	-	-	17	16

Figure 3-6 Control (PIQ) and feedback interface (PII)

Control interface PIQ (AB x to AB x+7):

Use the control interface to provide information for the IM151-1 FO STANDARD which modules actually have been installed and which slots have been left empty. The IM151-1 cannot evaluate the configuration until it has received this information.

Table 3- 5 Control interface

Slot	Value of the bit	Reaction
0	0	Content of the bitspur is not relevant
	1	Bitspur is valid
1 to 63	0	Slot does not exist in the actual configuration
	1	Slot exists in the actual configuration

Feedback interface PII (EB x to EB x+7):

The feedback interface (8 bytes) tells you which module is actually located on which slot.

Table 3- 6 Feedback interface

Slot	Value of the bit	Reaction
0	0	Option handling is inactive
	1	Option handling is active
1 to 63	0	Slot belongs to an option that does not exist or the module status is not OK
	1	Slot exists and is OK

If the feedback result of the feedback interface is identical with the specification of the control interface, the configuration is correct.

Procedure

In order to start testing the options, set Bit0=1 in the first byte (AB x).

Proceed as follows in order to ensure the consistency of the 8 bytes:

- Write the first byte (AB x) last (for direct access with T PAB)

or

- First write the complete information of the control interface in the first byte (AB x) with Bit0=0 and then set Bit0=1 in this byte in the subsequent OB1 cycle.

Alternatively you can use the SFC15 in order to achieve consistent transfer.

Note

Whenever any change in the 8 bytes of the control interface takes place, this information is stored and used, even if non-relevant bits were changed (bits outside the preset configuration).

3.3 Identification data

Definition

Identification data are data that are stored in a module for assisting the user in:

- Checking the system configuration
- Locating hardware modifications in a system
- Correcting errors in a system

Identification data enable modules to be uniquely identified online.

In *STEP 7*, the identification data are displayed in the "Module Information - IM 151" and "Properties - DP Slave" tabs (see *STEP 7* online help).

Reading the identification data with DS 255

As of 6ES7151-1AB05-0AB0, the IM 151-1 FO STANDARD also supports the standardized access to the identification data via the DS 255 (index 65000 to 65003). For further information on the data structure of the DS 255, refer to the PROFIBUS Guideline - Order No. 3.502, Version 1.1.1 dated March 2005.

Reading the identification data with DS 248

Users can directly access specific identification data by selecting **Read data record**. This requires a two-stage access:

1. Data record 248 contains a folder that holds the data records associated with the various indexes (see the table below.)

Table 3- 7 DS 248 structure for the ET 200S

List of contents	Length (bytes)	Coding (hex)
Header information		
ID of content directory	2	00 01
Index of content directory	2	00 00
Length of successive blocks in bytes	2	00 08
Number of blocks	2	00 05
Block information for identification data		
SSL	2	F1 11
associated data record number	2	00 E7
Length of the data record	2	00 40
Index	2	00 01
SSL	2	F1 11
associated data record number	2	00 E8
Length of the data record	2	00 40
Index	2	00 02
SSL	2	F1 11
associated data record number	2	00 E9
Length of the data record	2	00 40
Index	2	00 03
SSL	2	F1 11
associated data record number	2	00 EA
Length of the data record	2	00 40
Index	2	00 04
8 bytes of block information for additional data record objects		
	Σ: 48	

2. The relevant index assigned to a particular section of the ID data is found in the associated data record number (see the ID data table below.)
 - All data records which contain ID data have a length of 64 bytes.
 - The data record structure is based on the principle shown in the table below.

Table 3- 8 Basic structure of data records which contain ID data.

List of contents	Length (bytes)	Coding (hex)
Header information		
SSL	2	F1 11
Index	2	00 0x
Length of identification data	2	00 38
Number of blocks which contain ID data.	2	00 01
Identification data		
Index	2	00 0x
Identification data for the respective index (see table below)	54	

The identification data are assigned to the indices corresponding to the table below.

The data structures of data records 231 to 234 are compliant with the PROFIBUS Guideline - Order No. 3.502, Version 1.1.1 dated March 2005.

Reading of identification data

Table 3- 9 Identification data

Identification data	Access	Default setting	Description
Identification data 0: Index 1 (Data record 231)			
MANUFACTURER_ID	read (2 Byte)	2A hex (= 42 dec)	The name of the manufacturer is stored here. (42 dec = SIEMENS AG)
ORDER_ID	Read (20 bytes)	Depends on the module	Order number of the module
SERIAL_NUMBER	Read (16 bytes)	Not relevant	
HARDWARE_REVISION	read (2 Byte)	Not relevant	
SOFTWARE_REVISION	Read (4 bytes)	Firmware version	This indicates the firmware version of the module.
REVISION_COUNTER	read (2 Byte)	-	Provides information on parameter modifications on the module.
PROFILE_ID	read (2 Byte)	F600 hex	Generic Device
PROFILE_SPECIFIC_TYPE	read (2 Byte)	0003 hex 0005 hex	On electronic modules on interface modules
IM_VERSION	read (2 Byte)	0101 hex	Provides information on the ID data version (0101 hex = version 1.1)
IM_SUPPORTED	read (2 Byte)	000E hex	Provides information on existing identification data (index 2 to 4)
Maintenance data 1: Index 2 (Data record 232)			
TAG_FUNCTION	Read/write (32 bytes)	-	Define a unique identifier for the module in this record.
TAG_LOCATION	Read/write (22 bytes)	-	Enter the installation location of the module here.
Maintenance data 2: Index 3 (data record 233)			
INSTALLATION_DATE	Read/write (16 bytes)	-	Enter the installation date of the module here.
RESERVED	Read/write (38 bytes)	-	Reserved
Maintenance data 3: Index 4 (data record 234)			
DESCRIPTOR	Read/write (54 bytes)	-	Enter a comment on the module here.

Error and system messages

4.1 LED displays on the interface module

LED display

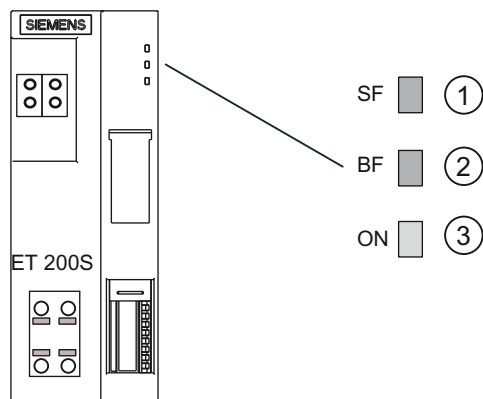

- ① Group error (red)
- ② Bus fault (red)
- ③ Supply voltage (green)

Status and error displays

Table 4- 1 Status and error messages of the IM151-1 FO STANDARD

Event (LEDs)			Cause	Remedy
SF	BF	ON		
Off	Off	Off	There is no voltage at the interface module, or the interface module has a hardware defect.	Switch on the 24 V DC supply voltage at the interface module.
*	*	On	There is voltage at the interface module.	---
*	Flashing	On	<p>The interface module is not configured or is configured incorrectly. No data exchange is taking place between the DP master and the interface module.</p> <p>Causes:</p> <ul style="list-style-type: none"> • The PROFIBUS address is incorrect. • Configuration error • Parameter assignment error 	<ul style="list-style-type: none"> • Check the interface module. • Check the configuration and parameter assignment. • Check the PROFIBUS address.

Event (LEDs)			Cause	Remedy
SF	BF	ON		
*	On	On	<p>Transmission rate detection, illegal PROFIBUS address, or bottom DIP switch (PROFIBUS address) not in the OFF position.</p> <p>Causes:</p> <ul style="list-style-type: none"> The response monitoring interval has elapsed. Bus communication to the interface module via PROFIBUS DP is interrupted. 	<p>Set a valid PROFIBUS address (1 to 125) on the interface module or check the bus configuration.</p> <ul style="list-style-type: none"> Check that the bus connector is correctly inserted. Check whether the connecting cable to the DP master has been disconnected. Switch the 24 V DC supply voltage on and off again at the interface module.
On	*	On	<p>Parameter "Operation with preset <=> actual configuration" enabled:</p> <p>The configured structure of the ET 200S does not match the actual structure of the ET 200S.</p> <p>Parameter "Operation with preset <=> actual configuration" disabled:</p> <p>See <i>LED display of the configuration and parameter assignment errors</i></p>	<p>Check the structure of the ET 200S for missing or defective modules or whether an unconfigured module is inserted.</p> <p>Check the configuration (using COM PROFIBUS or STEP 7, for example) and correct the parameter assignment error.</p>
			<p>There is an error in an I/O module, or the interface module is defective.</p>	<p>Replace the interface module, or contact your Siemens representative.</p>
Off	Off	On	<p>Data exchange is taking place between the DP master and the ET 200S.</p> <p>The set configuration and actual configuration of the ET 200S match.</p>	---
* Not relevant				

LED display of the configuration and parameter assignment errors

Properties

The configuration and parameter assignment errors of the ET 200S distributed I/O system are output at the interface module by means of the LEDs group error **SF** (red) and bus error **BF** (red).

Prerequisites

For the IM151-1 FO STANDARD, the function is available as of order number 6ES7151-1AB05-0AB0:

Operating principle

The information about the cause of the problem is determined by means of the LED fault display. After an announcement by means of a flashing signal, the respective error type and after that the error location / error code are displayed.

The LED fault display of the configuration and parameter assignment errors

- Is activated both during POWER ON and during operation.
- Takes precedence over all other states that are displayed by the SF and BF LED.
- Remains activated until the cause of the problem has been eliminated.

After a change in the ET 200S configuration, a POWER-OFF / POWER ON may be required at the interface module.

Sequence	Description
1	LEDs SF and BF flash 3x at 0.5 Hz
2	LED BF flashes at 1 Hz
3	LEDs SF and BF flash 3x at 2 Hz
4	LED SF flashes at 1 Hz
5	LED BF flashes at 1 Hz
6	Repetition of 1 - 5 until the cause of the problem has been eliminated.

Error code

Error type (BF)	Error location (SF/BF)	Cause	Remedy
1	01 to 63 (slot)	<p>Communication interruption</p> <p>Displays the first slot at which no I/O module is recognized.</p> <ul style="list-style-type: none"> • Missing I/O module during POWER ON or several I/O modules are missing during operation. • Interruptions at the rear panel bus • Short-circuit at the rear panel bus ("01" is output as the slot) • Terminating module missing <p>If the termination module is missing, the number of inserted I/O modules + 1 is output (if there is no set configuration)</p>	Check the configuration of the ET 200S.
2	01 to 63 (slot)	<p>Termination module not recognized</p> <p>This error type is output if there is a set configuration and the slot at which an I/O module is no longer recognized is equal to (number of modules of the set configuration + 1).</p>	Mount the terminating module.
3	01 to 63 (slot)	<p>I/O module</p> <p>The configured structure of the ET 200S does not match the actual structure of the ET 200S. The first slot that displays a configuration error (missing module, incorrect module module fault) is displayed.</p> <p>This error is only output if the parameter "Operation at preset <> actual configuration" is locked.</p>	Check the structure or the configuration of the ET 200S, whether a module is missing or defective, or whether an unconfigured module has been inserted.

The following errors can only occur if you have configured the ET 200S at a master from a different supplier or by using the GSD file:

Error type (BF)	Error location, error code (SF/BF)	Cause	Remedy
4	01	Configuration error at the option handling Option handling has been configured but no power module was configured for options handling.	Change the configuration.
	02 to 63 (slot)	Option handling has been configured but more than one power module was configured for options handling. The slot of the second power module that has option handling is displayed.	
5 ¹	01	General parameter assignment error The number of module parameter blocks in the parameter assignment telegram does not agree with the number of identifiers in the configuration telegram.	Correct the configuration.
	02	The maximum address area (inputs and outputs) of the interface module has been exceeded.	
	03	Incorrect structure of the parameter assignment telegram.	

¹ You prevent this error when configuration is carried out with STEP 7 and it is only possible if other configuration tools are used.

See also

Incorrect module configurations of ET 200S on the PROFIBUS DP (Page 55)
 Service & support (<http://www.siemens.com/automation/service&support>)

4.2 Process interrupt lost

"Process interrupt lost" Diagnostics

Modules with a controller use the "Process interrupt lost" diagnostics.

The "Process interrupt lost" diagnostics are not currently available for the 2DI 24 V DC High Feature and 4DI 24 V DC High Feature modules.

Note

Process interrupts should not be used for technological purposes (e.g. cyclical generation of process interrupts).

If more than approximately 90 process interrupts are generated per second, process interrupts may be lost.

4.3 Diagnostic messages of the electronic modules

Actions following a diagnostic message in DPV0 mode

The error is entered in the diagnostics frame in the channel-specific diagnostics:

- The SF LED of the interface module lights up.
- Several diagnostic messages can be output simultaneously.
- OB 82 is called. If OB82 is not available, the CPU goes into STOP.

Actions Following a Diagnostic Message in DPV1 mode

Each diagnostic message triggers the following actions:

- Diagnostics can be reported as diagnostic interrupts in DPV1 mode.
- A diagnostic message is
 - Entered in the diagnostic frame as a diagnostic interrupt block (always limited to one interrupt)
 - Written to the diagnostic buffer of the CPU
- The SF LED of the interface module lights up.
- OB 82 is called. If OB82 is not available, the CPU goes into STOP.
- Acknowledgment of the diagnostic interrupt (thereafter a new interrupt is possible).

4.4 Diagnostics with STEP 7

4.4.1 Diagnostics readout

Introduction

The slave diagnostics comply with IEC 61784-1:2002 Ed1 CP 3/1. Depending on the DP master, slave diagnostics can be read out with *STEP 7* for all DP slaves that comply with the standard.

Length of the diagnostics frame

- The maximum frame length for the ET 200S is as follows:
 - IM151-1 FO STANDARD (DPV0 mode): 62 bytes
 - IM151-1 FO STANDARD (DPV1 mode): 110 bytes
- The minimum frame length is
 - 6 bytes (identifier-related diagnostics, module status, and channel-specific diagnostics disabled via parameter assignment).

Options for reading out the diagnostics

The table below shows the options for reading out the diagnostics with *STEP 7* on PROFIBUS DP.

Table 4- 2 Reading out the diagnostics with STEP 7 on PROFIBUS DP

Automation system with DP master	Block or tab in <i>STEP 7</i>	Application	Reference
SIMATIC S7/M7	"DP Slave Diagnostics" tab	Slave diagnostics in plain text on the STEP 7 user interface	"Diagnosing hardware" in <i>STEP 7</i> Online Help
	SFC 13 "DP NRM_DG"	Reading out slave diagnostics (store in the data area of the user program)	SFC see <i>STEP 7 Online Help</i>
	SFC 59 "RD_REC"	Reading out S7 diagnostic data records (save to the data area of the user program)	See "System and Standard Functions" Reference Manual
	SFB 52 "RDREC"	Reading data records from the DP slave	SFB see <i>STEP 7 online help</i> (system functions/-function blocks)
	SFB 54 "RALRM" ¹	Receiving interrupts from interrupt OBs	SFB see <i>STEP 7 online help</i> (system functions/-function blocks)
¹ only for S7-400 from V3.0 and CPU 318 from V3.0			

Example of reading out S7 diagnostics using SFC 13 "DP NRM_DG"

Here, you will find an example of how to use SFC 13 to read out the slave diagnostics for a DP slave in the STEP 7 user program.

For the purpose of this STEP 7 user program, the following is assumed:

- The diagnostic address of the ET 200S is 1022 (3FE_H).
- The slave diagnostics are to be stored in DB 82: Starting from address 0.0, length = 64 bytes.
- The slave diagnostics consist of a maximum of 64 bytes (IM151-1 FO STANDARD in DPV0 mode).

STEP 7 user program

STL	Description
CALL SFC 13	
REQ :=TRUE	Read request
LADDR :=W#16#3FE	Diagnostic address of the ET 200S
RET_VAL :=MW0	RET_VAL of SFC 13
RECORD :=P#DB82.DBX 0.0 BYTE 64	Data record for the diagnostics in DB 82
BUSY :=M2.0	The read process runs through several OB 1 cycles

4.4.2 Structure of the slave diagnostics

Structure of the slave diagnostics

The figure below shows the structure of the slave diagnostics.

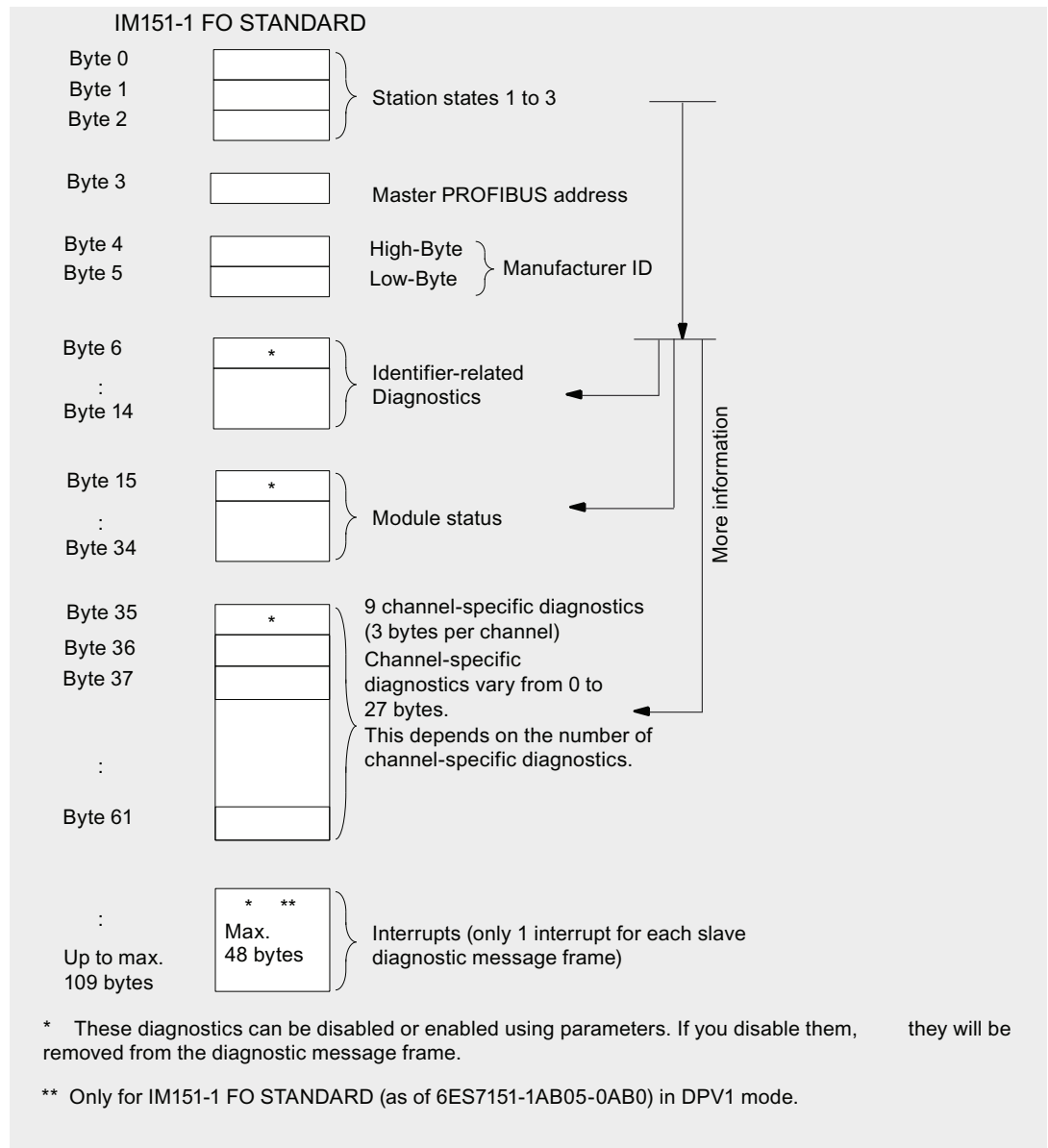

Figure 4-1 Slave diagnostics structure

Note

The length of the diagnostics frame varies depending on the parameter assignment:

- Between 6 and 62 bytes in DPV0 mode
- Between 6 and 110 bytes in DPV1 mode

You can identify the length of the last received diagnostics frame in *STEP 7* by referring to the RET_VAL parameter of the SFC 13.

4.4.3 Station statuses 1 to 3

Definition

Station statuses 1 to 3 provide an overview of the status of a DP slave.

Structure of station status 1 (byte 0)

Table 4- 3 Structure of station status 1 (byte 0)

Bit	Meaning	Cause/Remedy
0	1: The DP slave cannot be accessed by the DP master.	<ul style="list-style-type: none"> • Is the correct PROFIBUS address set on the DP slave? • Is the bus connector plugged in? • Is the DP slave connected to the voltage supply? • Is the RS-485 repeater set correctly? • Has the DP slave been reset?
1	1: The DP slave is not yet ready to exchange data.	<ul style="list-style-type: none"> • Wait, the DP slave is currently starting up.
2	1: The configuration data transferred from the DP master to the DP slave does not match the slave configuration.	<ul style="list-style-type: none"> • Has the correct station type or the correct DP slave configuration been entered in the configuration software?
3	1: External diagnostics information is pending. (Group diagnostics display)	<ul style="list-style-type: none"> • Evaluate the ID-specific diagnostics information, the module status, and/or the channel-specific diagnostics information. As soon as all errors have been eliminated, bit 3 will be reset. The bit will be set again when there is a new diagnostics message in the bytes of the aforementioned diagnostics.
4	1: The required function is not supported by the DP slave (for example, changing the PROFIBUS address by means of software).	<ul style="list-style-type: none"> • Check the configuration.
5	1: The DP master cannot interpret the response of the DP slave.	<ul style="list-style-type: none"> • Check the bus configuration.
6	1: The DP slave type does not match the software configuration.	<ul style="list-style-type: none"> • Has the correct station type been entered in the configuration software?
7	1: Parameters have been assigned to the DP slave by a different DP master (not the one that currently has access to the DP slave).	<ul style="list-style-type: none"> • The bit is always 1, for example, if you access the DP slave with the programming device or another DP master. • The PROFIBUS address of the DP master that assigned parameters to the DP slave is located in the "Master PROFIBUS address" diagnostics byte.

Structure of station status 2 (byte 1)

Table 4- 4 Structure of station status 2 (byte 1)

Bit	Meaning	
0	1:	The DP slave parameters need to be reassigned.
1	1:	A diagnostics message is pending. The DP slave will not operate until the problem is eliminated (static diagnostics message).
2	1:	The bit on the DP slave is always "1".
3	1:	The watchdog is activated for this DP slave.
4	1:	The DP slave has received the "FREEZE" control command ¹ .
5	1:	The DP slave has received the "SYNC" control command ¹ .
6	0:	Bit is always "0".
7	1:	The DP slave is disabled, that is, it has been removed from the processing in progress.

¹ The bit is updated only if another diagnostics message changes also.

Structure of station status 3 (byte 2)

Table 4- 5 Structure of station status 3 (byte 2)

Bit	Meaning	
0 to 6	0:	Bits are always set to "0".
7	1:	<ul style="list-style-type: none"> • There are more diagnostics messages pending than the DP slave is able to store. • The DP master cannot enter all the diagnostics messages sent by the DP slave in its diagnostics buffer (channel-specific diagnostics).

4.4.4 Master PROFIBUS address

Definition

The Master PROFIBUS address diagnostics byte contains the PROFIBUS address of the DP master:

- That assigned parameters to the DP slave
- That has read and write access to the DP slave

The master PROFIBUS address is located in byte 3 of the slave diagnostics.

4.4.5 Identifier-related diagnostics

Definition

The identifier-related diagnostics indicate whether or not modules of the ET 200S have errors/faults. Identifier-related diagnostics start at byte 6 and are 9 bytes long.

The identifier-related diagnostics for the ET 200S with the IM151-1 FO STANDARD are structured as follows:

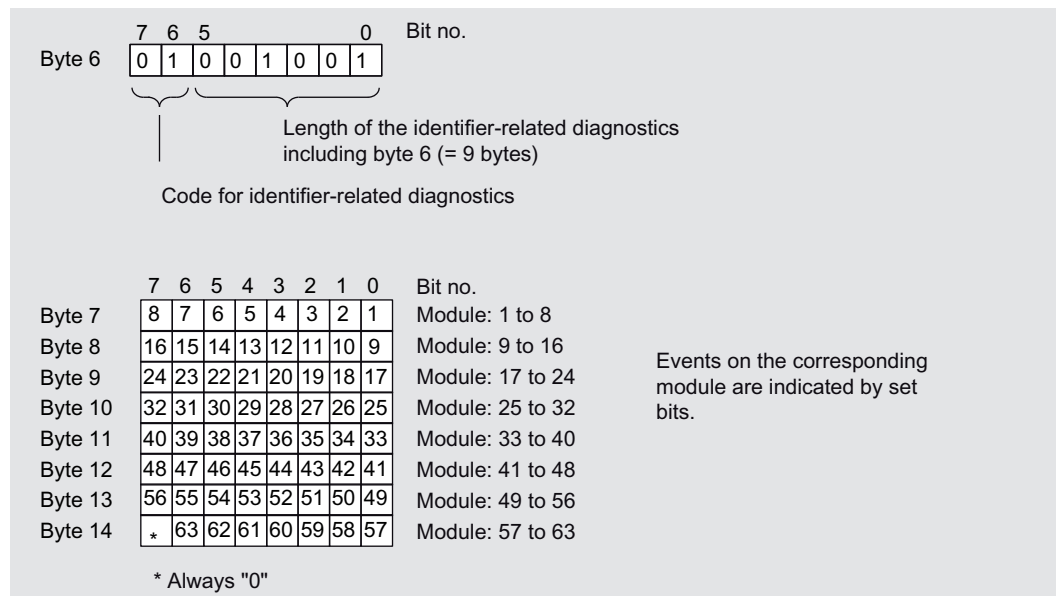

Figure 4-2 Structure of the identifier-related diagnostics for the ET 200S with the IM151-1 FO STANDARD

4.4.6 Module status

Definition

The module status indicates the status of the configured modules and provides more information on the identifier-related diagnostics with respect to the configuration. The module status starts after the identifier-related diagnostics and consists of 20 bytes.

Structure of the module status

The module status for the ET 200S with the IM151-1 FO STANDARD is structured as follows:

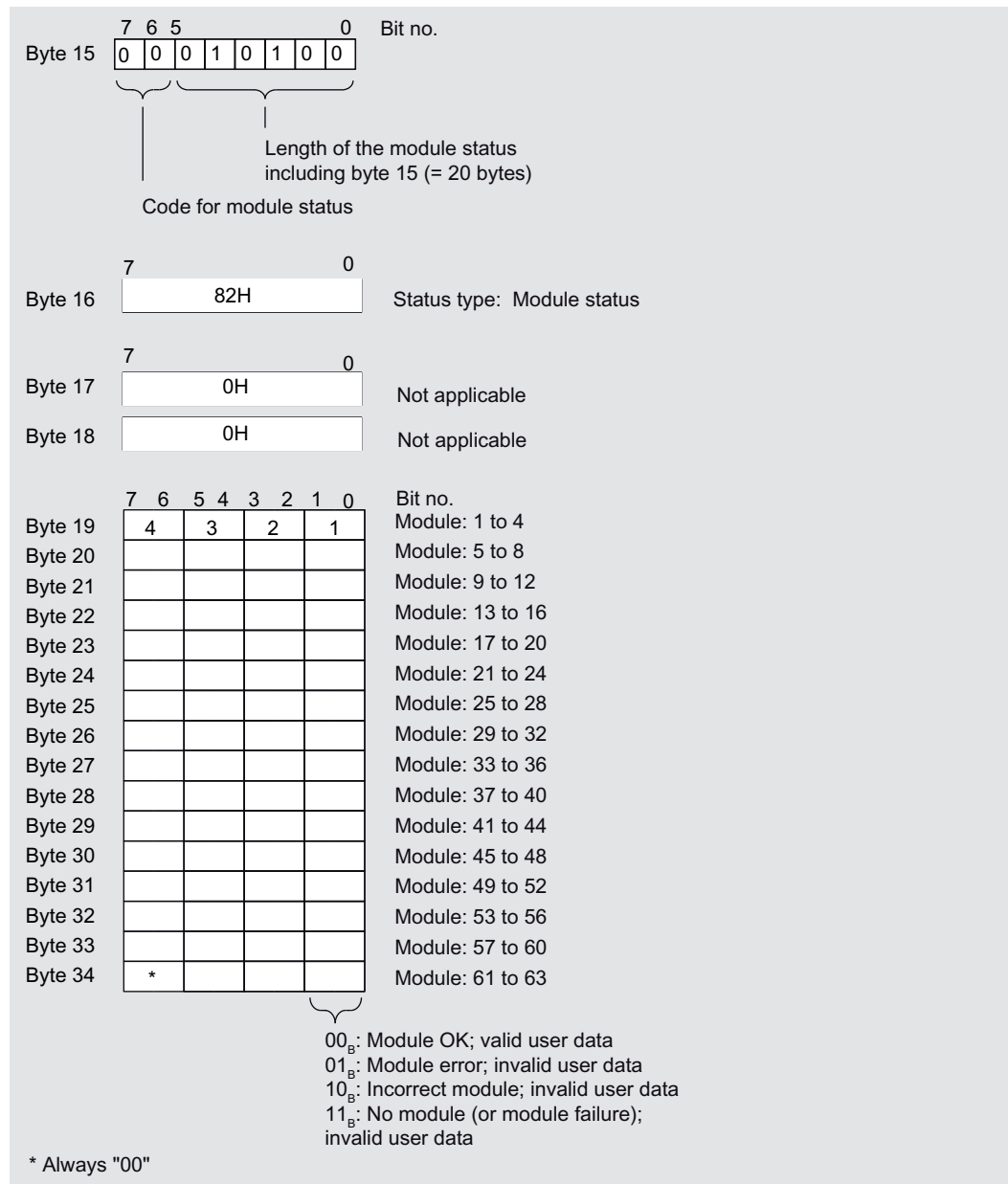

Figure 4-3 Structure of the module status for the ET 200S with the IM151-1 FO STANDARD

4.4.7 Channel-specific diagnostics

Definition

Channel-specific diagnostics provide information about channel errors in modules and details of the identifier-related diagnostics. The channel-specific diagnostics start after the module status (if parameters are preset accordingly). The maximum length is limited by the maximum total length of the slave diagnostics, i.e., 62 bytes in DPV0 mode or 110 bytes in DPV1 mode. Channel-specific diagnostics do not affect the module status.

A maximum of 9 channel-specific diagnostic messages are possible in DPV0/DPV1 mode.

Structure of channel-specific diagnostics

The channel-specific diagnostics for the ET 200S with the IM151-1 FO STANDARD are structured as follows:

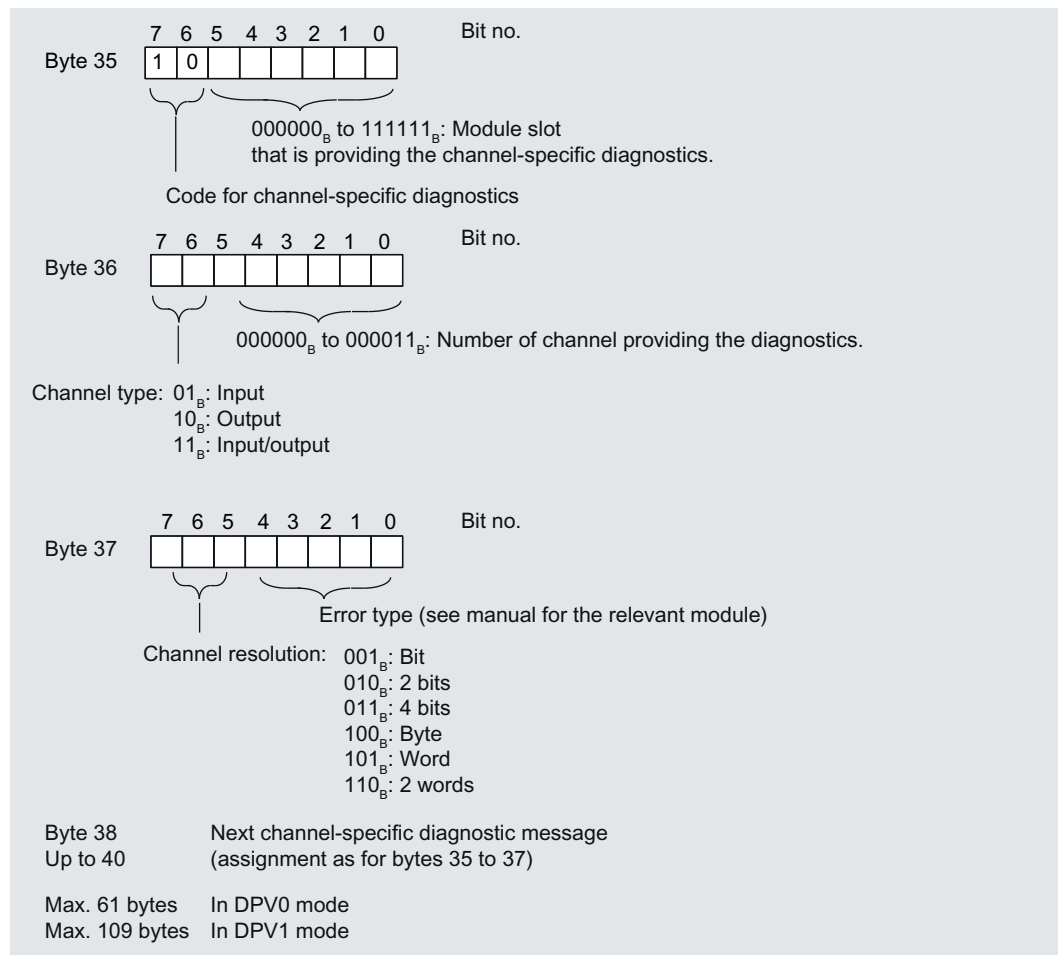

Figure 4-4 Structure of the channel-specific diagnostics for the ET 200S with the IM151-1 FO STANDARD;

Note

The module slot coding is contained in byte 35, bits 0 to 5. The following applies: Displayed number +1 \triangleq Slot of the module (0 \triangleq Slot 1; 1 \triangleq Slot 2; 3 \triangleq Slot 4, etc.)

In bits 6/7 of byte 36, 00_B is output if a power module reports channel-specific diagnostics.

4.4.8 Interrupts

Definition

The interrupt section of the slave diagnostics indicates the interrupt type and the event that led to an interrupt being triggered. The interrupt part consists of a maximum of 48 bytes.

Position in the diagnostic frame

The interrupt section comes after the channel-specific diagnostics (only in DPV1 mode).

Example: If 3 channel-specific diagnostics are pending, then the interrupt section starts at byte 44.

Data records

The diagnostic data of a module can be up to 44 bytes in length and is located in data records 0 and 1:

- Data record 0 contains 4 bytes of diagnostic data describing the current status of an automation system. DS0 is part of the header information of OB 82 (local data bytes 8 to 11).
- Data record 1 contains the 4 bytes of diagnostic data that is also contained in data record 0 and, in addition, up to 40 bytes of module-specific diagnostic data.

DS0 and DS1 can be read out with SFC 59 "RD_REC."

Contents

The contents of the interrupt information depend on the interrupt type:

- In the case of diagnostic interrupts, diagnostic data record 1 (up to 44 bytes) is sent as the interrupt status information (starting from byte x+4).
- The status information for process interrupts is 4 bytes in length.
- In the case of insert/remove module interrupts, the interrupt status information is 0 bytes long.

Structure of interrupts

Once configuration with *STEP 7* is complete, the interrupt data is evaluated and transferred to the relevant organization blocks (OBs).

The interrupt section for the ET 200S is structured as follows:

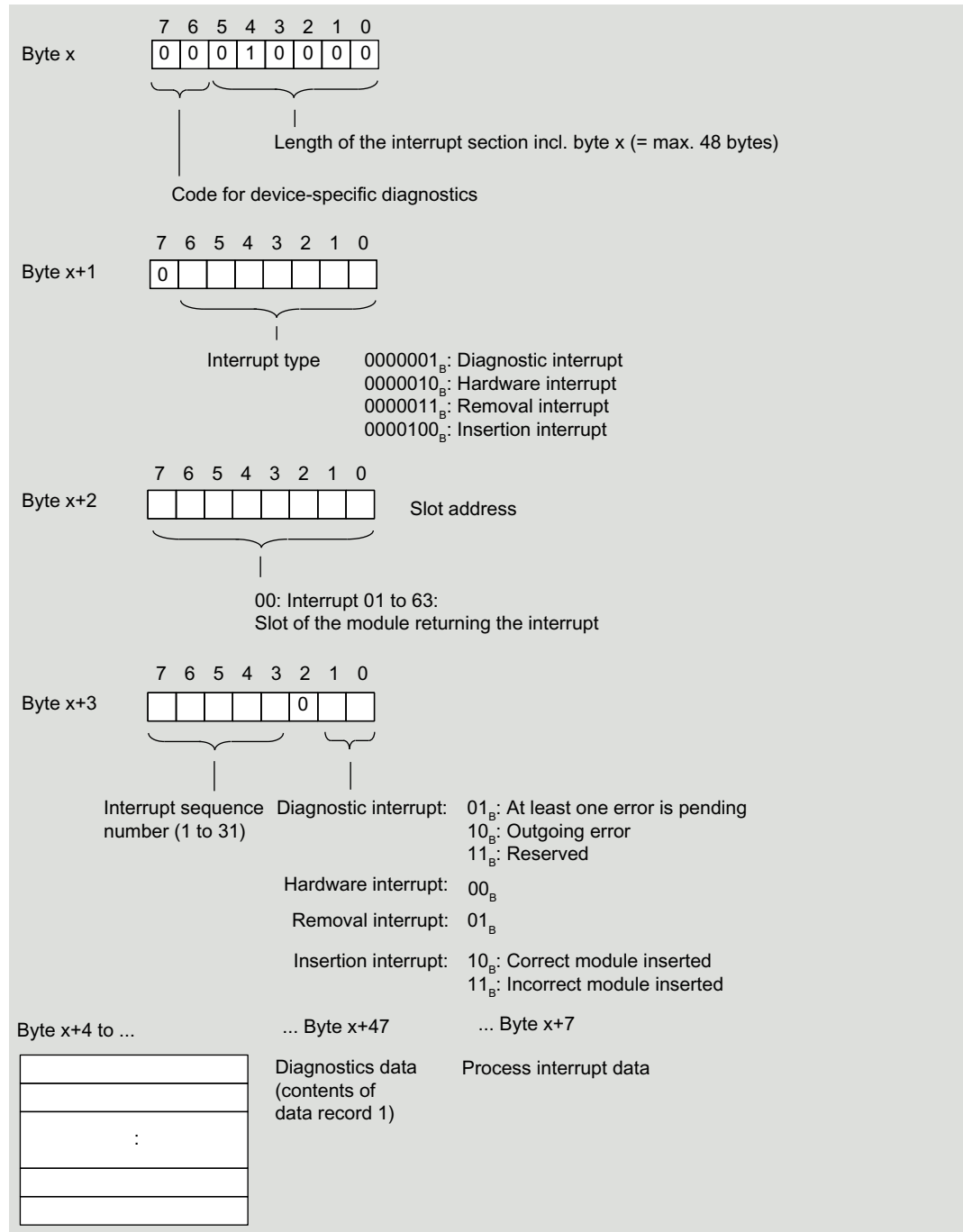

Figure 4-5 Structure of the interrupt status of the interrupt section

Diagnostic interrupt, byte x+4 to x+7

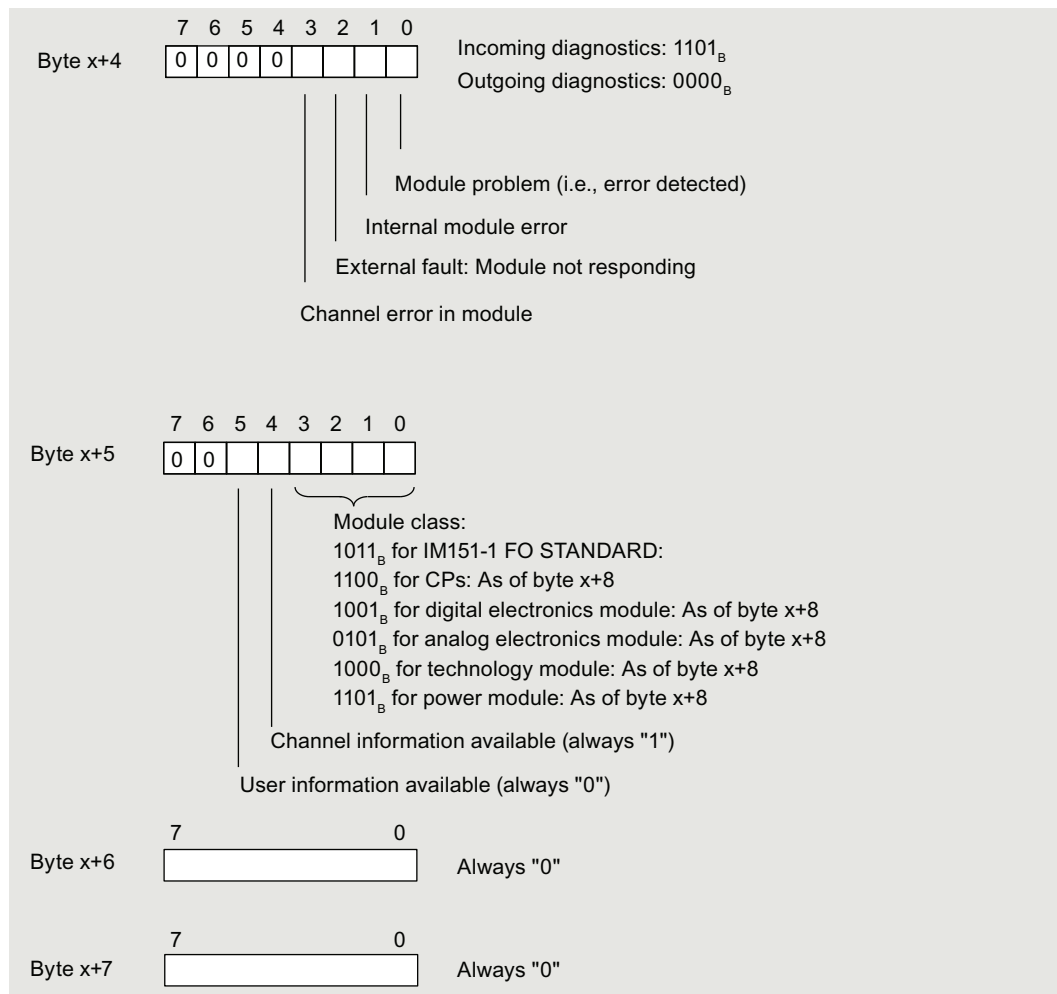

Figure 4-6 Structure of bytes x+4 to x+7 for diagnostic interrupt

Diagnostic interrupt from the modules, byte x+8 to byte x+11

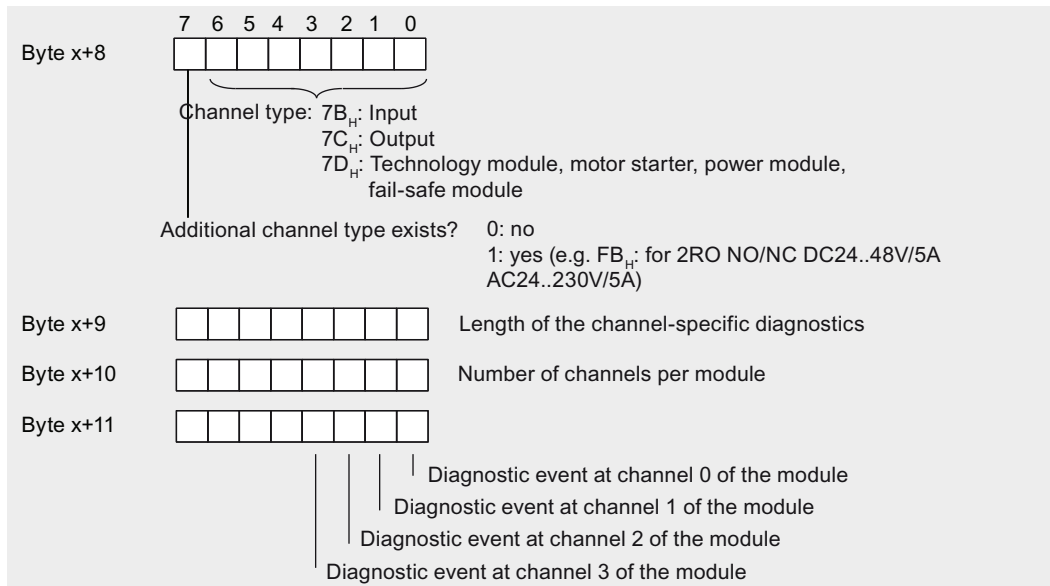

Figure 4-7 Structure of byte x+8 to byte x+11 for diagnostic frame

Diagnostic interrupt from the modules, byte x+12 to byte x+15

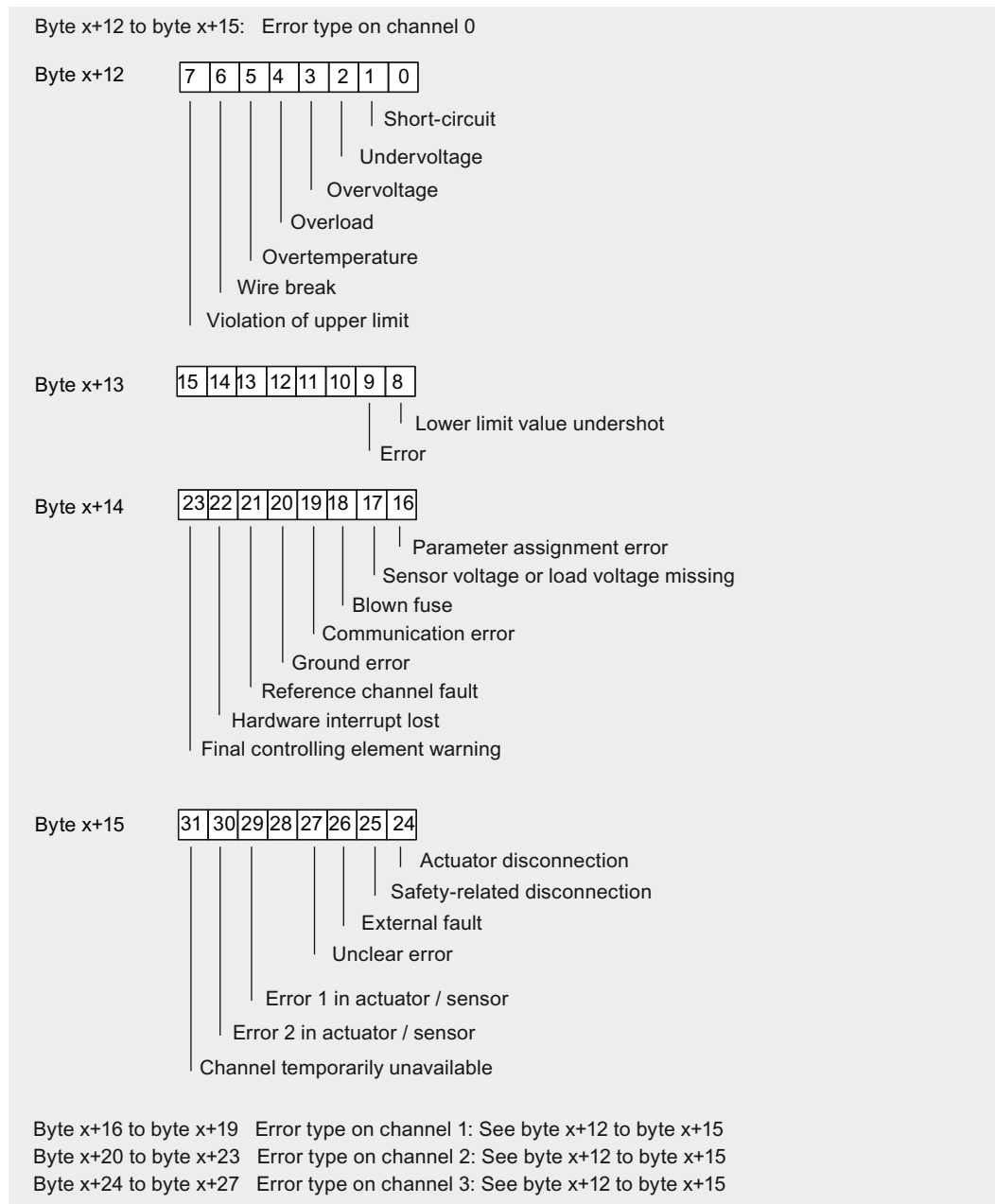

Figure 4-8 Structure of byte x+12 to byte x+15 for diagnostic frame

Example of a diagnostic interrupt

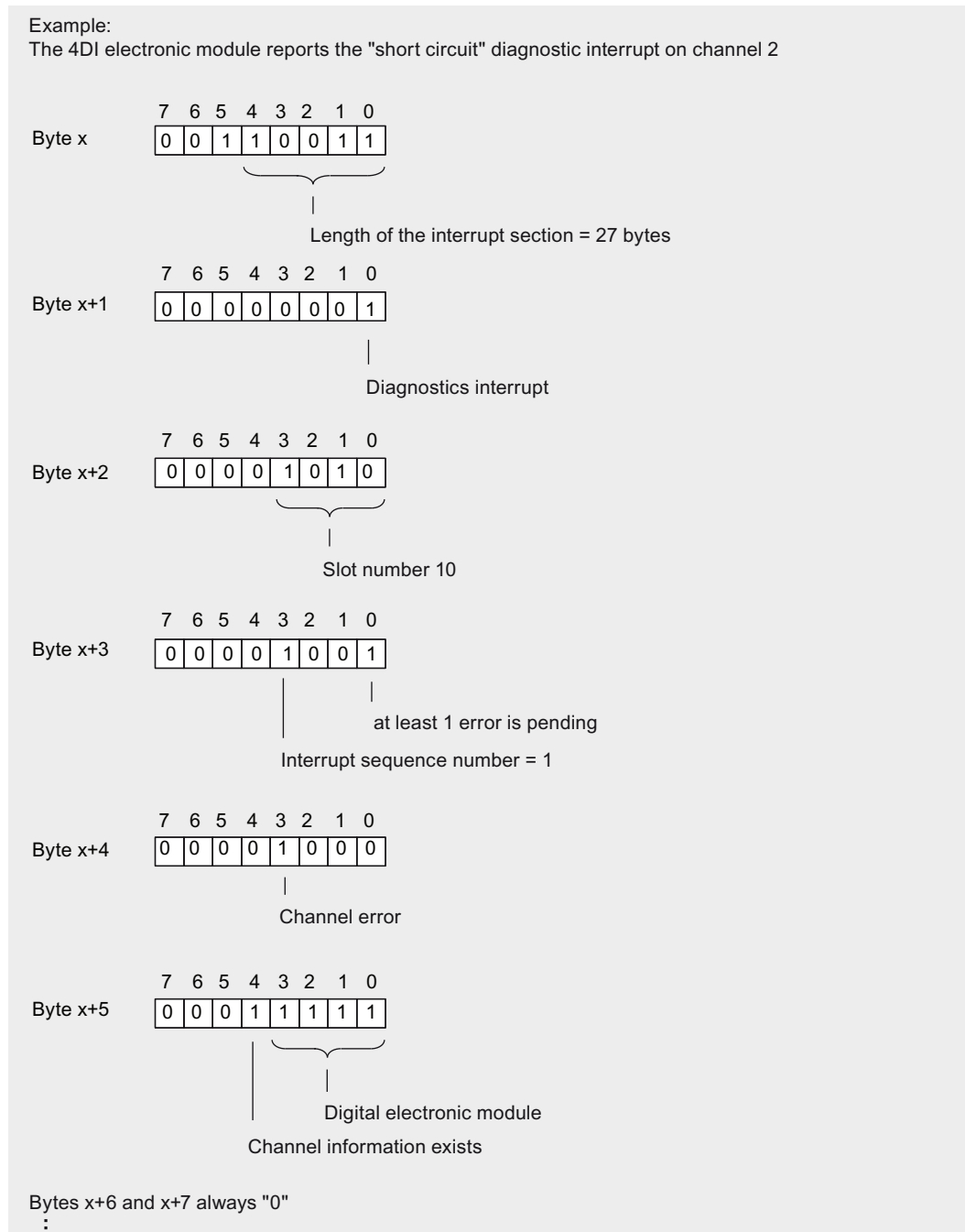

Figure 4-9 Example of a diagnostic interrupt (Part 1)

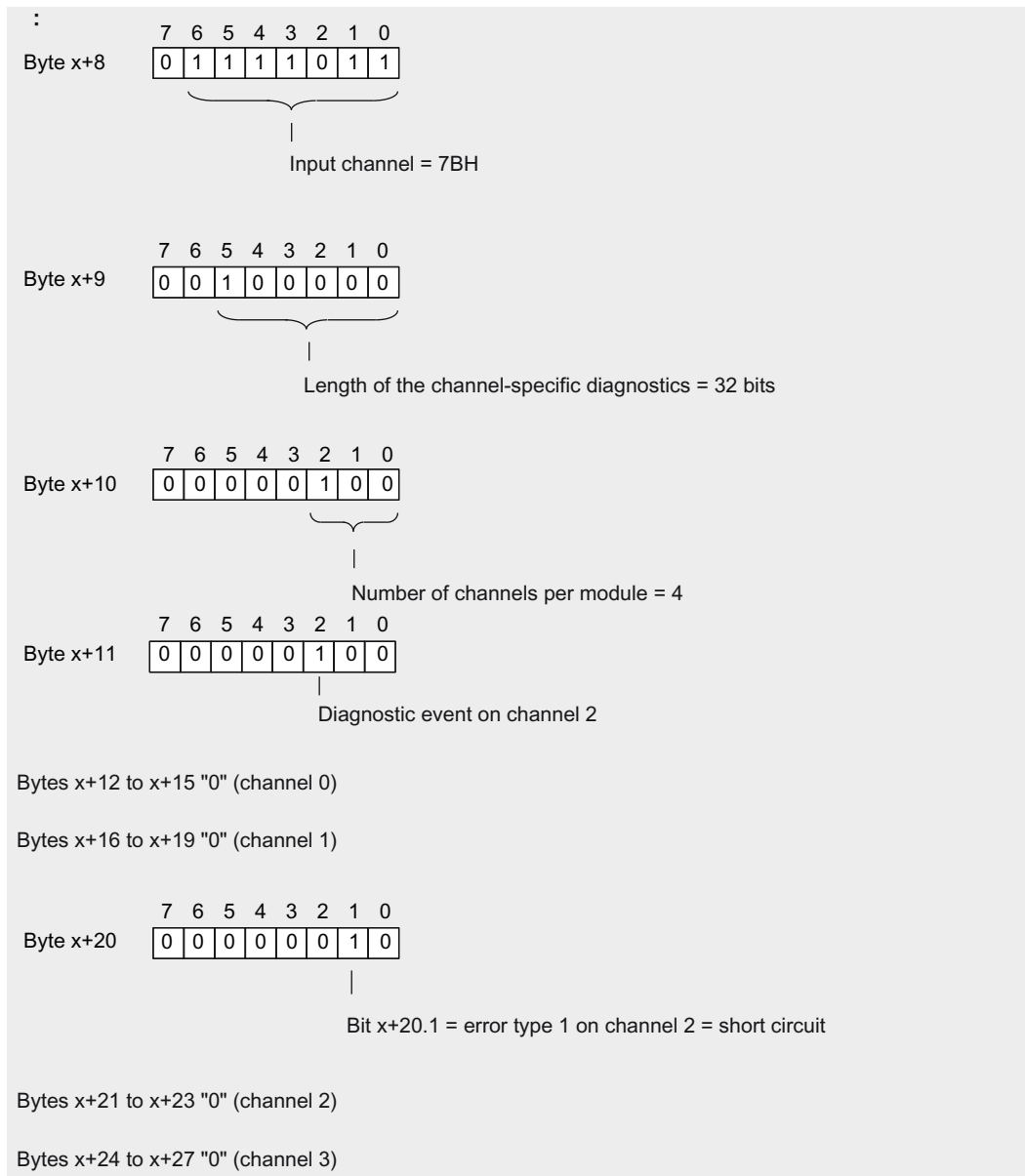

Figure 4-10 Example of a diagnostic interrupt (Part 2)

Process interrupt of digital input modules

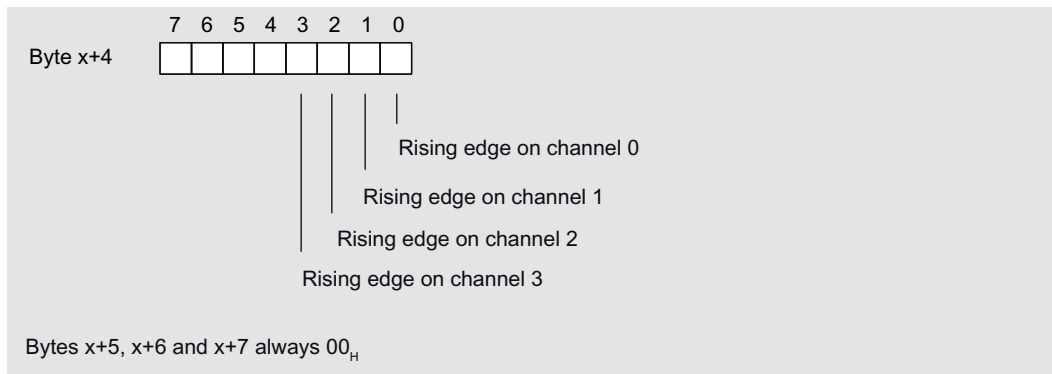

Figure 4-11 Structure as of byte x+4 for process interrupt (digital input)

Process interrupt of analog input modules

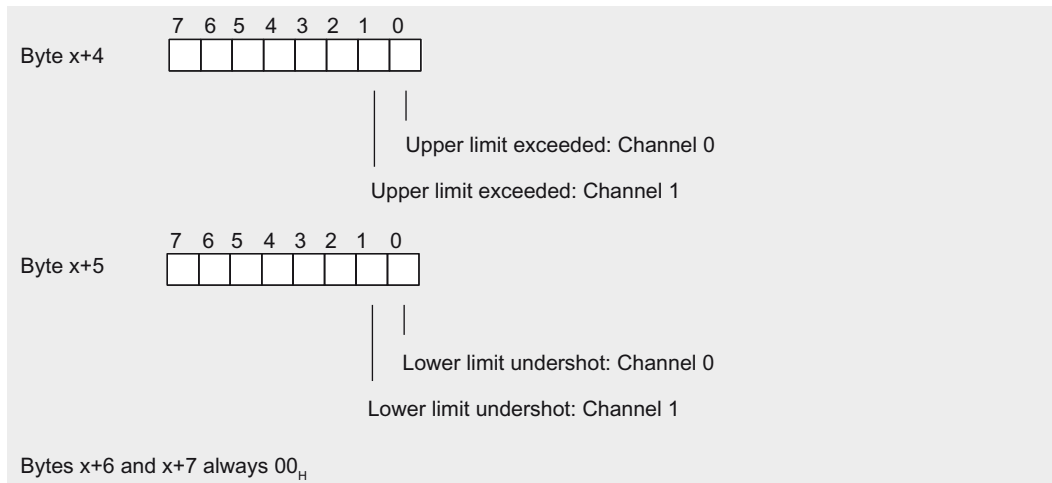

Figure 4-12 Structure as of byte x+4 and byte x+5 for process interrupt (analog input)

4.4.9 Incorrect module configurations of ET 200S on the PROFIBUS DP

Invalid module configuration states

The following invalid ET 200S module configuration states lead to an ET 200S station failure or prevent entry into data exchange. These responses occur regardless of whether the IM parameters "Operation at set <> actual configuration", "Replace modules during operation", and "Startup at set <> actual configuration" have been enabled.

- Two missing modules
- Terminating module missing
- Number of modules exceeds maximum configuration
- Backplane bus fault (for example, defective terminal module)

Note

The station will not start up if **one** module is missing (gap) and the ET 200S is switched on.

Diagnostics

You can identify any invalid module configuration states on the basis of the following diagnostics:

Identifier-related diagnostics	Module status
All 63 bits set	<ul style="list-style-type: none">• 01B: "Module error; invalid user data" for all modules (slots) until the cause of the error is found• 11B: "No module; invalid user data" once the cause of the error is found

See also

LED displays on the interface module (Page 33)

4.4.10 DP slave failure

DP slave failure

DP slave failure means data exchange will stop and user data (inputs and outputs) will no longer be exchanged between DP master and DP slave.

Events

A DP slave failure can be triggered by the following events:

- Events from the DP master: e.g. when loading a new configuration, in case of a connection interruption or if the device is switched off
- Events from the DP slave ("DP slave failure"): e.g. wrong disassemble conditions (Page 55)

The DP slave still works and communicates, which means it delivers diagnostics, reacts to events of the I/O modules and can process data records. The cause for the DP slave failure can be determined based on the diagnostics.

4.5 Evaluating the interrupts of the ET 200S

Introduction

In the case of certain process states/errors, the DP slave saves one interrupt block for each process state or error, containing the relevant information, in the diagnostic frame (DPV1 interrupt mechanism). Regardless of this, the diagnostic status of the DP slave is tracked in the identifier-related diagnostics, the module status, and the channel-specific diagnostics.

Interrupts in DPV0 mode

For DPV0 mode, no interrupts are defined in accordance with the PROFIBUS standard. This means that interface modules do not trigger an interrupt in DPV0 mode.

Interrupts in DPV1 mode

The ET 200S supports the following interrupts:

- Diagnostic interrupts
- Process interrupts
- Remove/insert module interrupts

Requirements: Interrupts are only supported when you run the ET 200S with IM151-1 FO STANDARD interface modules (6ES7151-1AB05-0AB0 or higher) in DPV1 mode.

In the event of an interrupt, interrupt OBs are automatically executed in the CPU of the DP master (see information on Program design in the System Software for S7-300/S7-400 Programming Manual (<http://support.automation.siemens.com/WW/view/en/1136533>)).

Triggering a diagnostic interrupt

When an incoming or outgoing event (e.g., a wire break) is registered, the module triggers a diagnostic interrupt if "Enable: Diagnostic interrupt" is set.

The CPU interrupts processing of the user program and processes the OB 82 diagnostic block instead. The event that triggered the interrupt is entered in the OB 82 start information.

Evaluating hardware interrupts with *STEP 7*

When a process interrupt occurs, the CPU interrupts the processing of the user program and processes the OB 40 process interrupt block.

The module channel that triggered the process interrupt is entered in the start information of OB 40, in the OB40_POINT_ADDR variable. The figures below show how the local data double word 8 is assigned to the bits.

Process interrupts in electronic modules 2DI DC24V HF and 4DI DC24V HF:

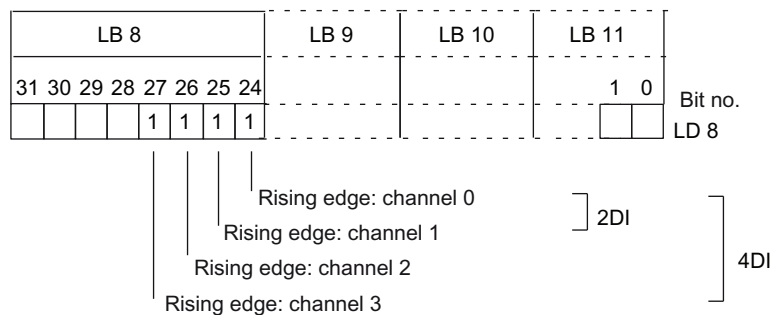

Figure 4-13 OB 40 start information: The event that triggered the process interrupt for digital input modules

Process interrupts for 2 AI U HS, 2 AI I 2WIRE HS and 2 AI I 4WIRE HS electronic modules:

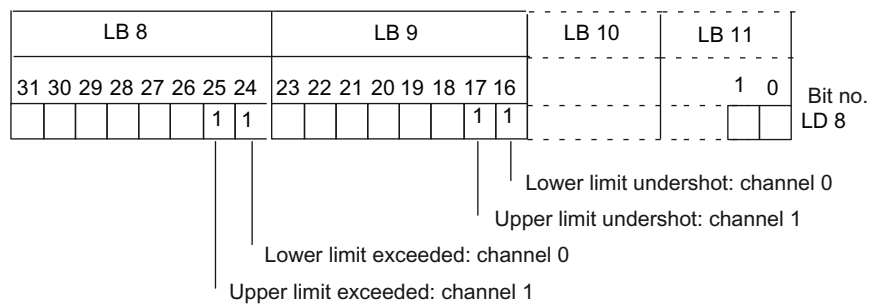

Figure 4-14 OB 40 start information: The event that triggered the process interrupt for analog input modules

You will find a description of OB 40 in the System and Standard Functions Reference Manual for S7-300 /400 (<http://support.automation.siemens.com/WWW/view/en/1214574>).

Triggering a insert/remove module interrupt

Insert/remove-module interrupts are supported in DPV1 mode. The CPU interrupts processing of the user program and processes diagnostic block OB 83 instead. The event that triggered the interrupt is entered in the OB 83 start information.

Response times

5.1 Overview

The figure below shows the various response times between DP Master and ET 200S.

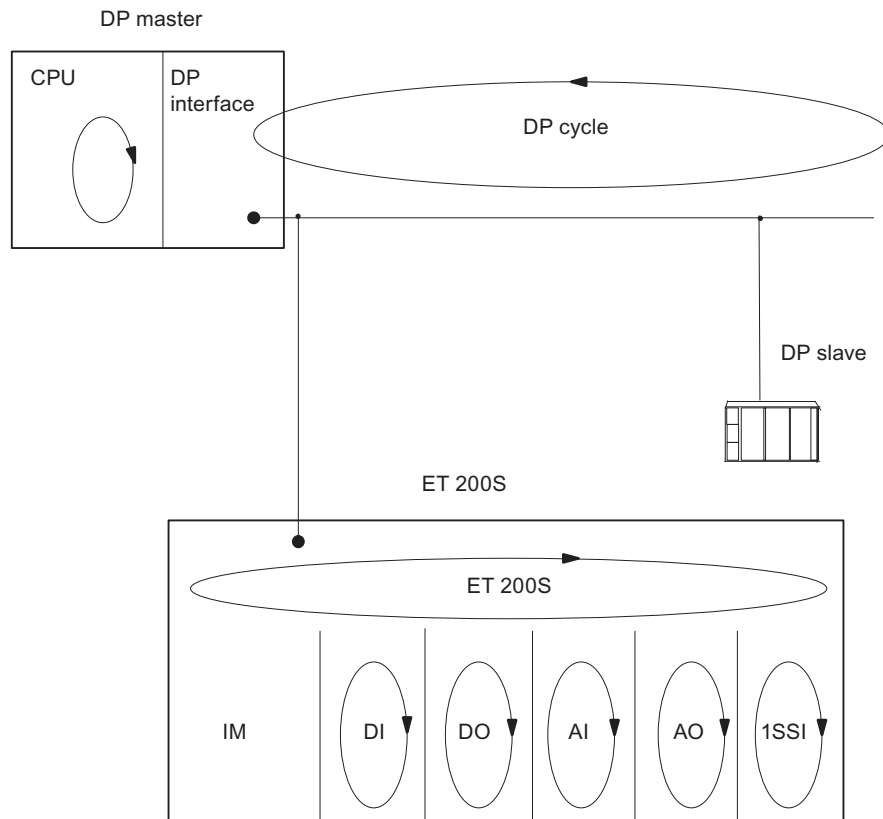

Figure 5-1 Response times between DP Master and ET 200S

5.2 Response times for the ET 200S

Calculating the response time with the IM151-1 FO STANDARD

The following equation enables you to make an approximate calculation of the ET 200S response time:

$$\text{Response time } [\mu\text{s}]^* = 28 \cdot m + 9 \cdot b + 350$$

Explanation of the parameters:

- **m**: Sum total of all configured modules
- **b**: Sum total of all input and output bytes (without bit granular modules)

Example for calculating the ET 200S response time (as of 6ES7151-1AB05-0AB0)

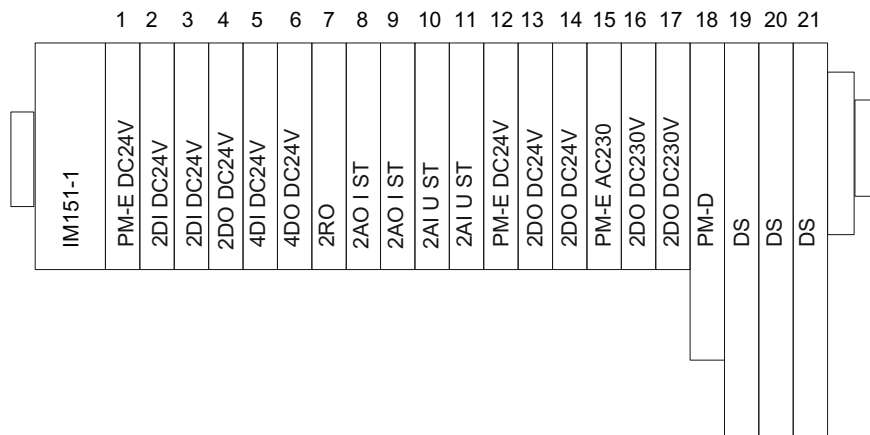

Figure 5-2 Example setup for calculating the response time with the IM151-1 FO STANDARD

Calculation method:

$$m = 21; b = 16$$

$$\text{Response time} = 28 \cdot m + 9 \cdot b + 350$$

$$\text{Response time} = 28 \cdot 21 + 9 \cdot 16 + 350$$

$$\text{Response time} = 1082 \mu\text{s}$$

5.3 Response time for digital input modules

Input delay

The reaction times of the digital input modules depend on the input delay.

Reference

Information on the input delays can be found in the technical data of the *manual* for the relevant digital electronic module.

5.4 Response time for digital output modules

Output delay

The response times correspond to the output delay.

Reference

Information on the output delays can be found in the technical data of the *manual* for the relevant digital electronic module.

5.5 Response time for analog input modules

Conversion time

The conversion time comprises the basic conversion time and the processing time for wire break check diagnostics.

In integrative conversion processes, the integration time is included directly in the conversion time.

Cycle time

The analog/digital conversion and the transfer of the digitized measured values to memory or to the backplane bus take place sequentially. In other words, the analog input channels are converted one after the other. The cycle time, that is, the time until an analog output value is converted again, is the sum of the conversion times of all the activated analog output channels of the analog input modules. You should deactivate unused analog input channels during parameter assignment in order to reduce the cycle time. The conversion and integration time for a deactivated channel is 0.

The following figure gives you an overview of what the cycle time for an n-channel analog input module comprises.

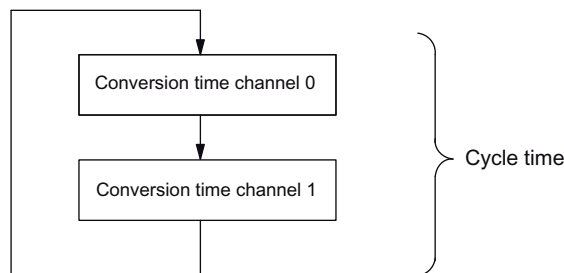

Figure 5-3 Cycle time of the analog input module

Reference

Information on the conversion times can be found in the technical data of the *manual* for the relevant analog electronic module.

5.6 Reaction times of analog output modules

Conversion time

The conversion time of the analog output channels comprises the time for the transfer of the digitized output values from internal memory and the digital/analog conversion.

Cycle time

The conversion of the analog output channels for the module takes place with a processing time and sequentially with a conversion time for channels 0 and 1.

The cycle time, i.e. the time until an analog output value is converted again, is the sum of the conversion times of all the activated analog output channels and of the processing time of the analog output module.

The following figure provides you with an overview of what makes up the cycle time for an analog output module.

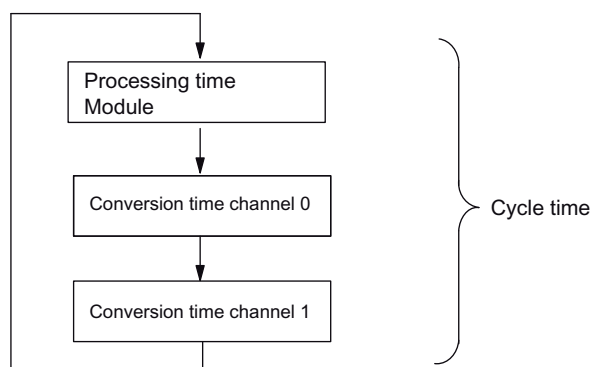

Figure 5-4 Cycle time of the analog output module

Settling time

The settling time (t_2 to t_3) i.e. the time from the application of the converted value until the specified value is obtained at the analog output - depends on the load. A distinction must be drawn between resistive, capacitive, and inductive loads.

Response time

The response time (t_1 to t_3) i.e., the time from the application of the digital output values in internal memory until the specified value is obtained at the analog output - is, in the most unfavorable case, the sum of the cycle time and the settling time. The most unfavorable case is when the analog channel is converted shortly before the transfer of a new output value and is not converted again until after the conversion of the other channels (cycle time).

This figure shows the response time of an analog output channel:

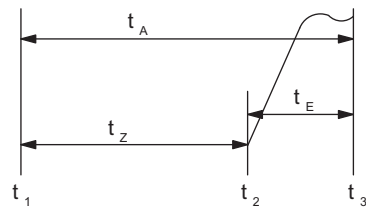

t_A	Response time
t_Z	Cycle time, corresponding to the processing time of the module and the conversion time of the channel
t_E	Settling time
t_1	new digital value applied
t_2	output value transferred and converted
t_3	specified output value obtained

Figure 5-5 Response time of an analog output channel

Reference

Information on the conversion times can be found in the technical data of the *manual* for the relevant analog electronic module.

5.7 Response times for a 4 IQ-SENSE electronic module

The response time of the 4 IQ-SENSE electronic module is specified as a cycle time in the Technical Data.

5.8 Response times for technology modules

The response times of the technology modules are specified as response time or update rate in the Technical Data. See *ET 200S Technological Functions Manual*.

Order numbers

A

Accessories

Table A- 1 Order numbers of accessories

Name	Order Number
Optical Link Module OLM / P11 V4.0 OLM / P12 V4.0	6GK1503-2CA00 6GK1503-3CA00
Optical bus terminal (OBT)	6GK1500-3AA00
Fiber-optic cable	
<ul style="list-style-type: none"> SIMATIC NET PROFIBUS plastic fiber-optic, duplex core (50 m ring) 	6XV1821-2AN50
<ul style="list-style-type: none"> SIMATIC NET PROFIBUS plastic fiber optic, standard cable <ul style="list-style-type: none"> Sold by the meter 50 m ring 100 m ring 	6XV1821-0AH10 6XV1821-0AN50 6XV1821-0AT10
<ul style="list-style-type: none"> SIMATIC NET PROFIBUS PCF Fiber Optic, assembled with 2 x 2 BFOC plugs, standard cable, various lengths from 75 m to 400 m 	6XV1821-1Bxxx
<ul style="list-style-type: none"> SIMATIC NET PROFIBUS PCF Fiber Optic, assembled with 2 x 2 Simplex plugs, standard cable, various lengths from 50 m to 300 m 	6XV1821-1Cxxx
Plugs for fiber-optic cable	
<ul style="list-style-type: none"> Package of 100 simplex connectors and 5 polishing sets 	6GK1901-0FB00-0AA0
<ul style="list-style-type: none"> Package of 50 plug adapters 	6ES7195-1BE00-0XA0
<ul style="list-style-type: none"> SIMATIC NET, Termination Kit SIMPLEX PLUG assembly case for the on-site assembly of Simplex plugs to PCF LWL wires 	6GK1900-0KL00-0AA0
<ul style="list-style-type: none"> Simplex Plug PCF for on-site assembly of PCF LWL wires; Pack with 50 Simplex plugs and cleaning tissues 	6GK1900-0KB00-0AC0
Termination module	6ES7193-4JB00-0AA0
Connection plug 24V power supply, PUSH-IN clamps	6ES7193-4JB00-0AA0
<ul style="list-style-type: none"> Pack with 10 units 	
Connecting plug 24V power supply, terminal	6ES7193-4JB50-0AA0
<ul style="list-style-type: none"> Pack with 10 units 	

Index

B

Basic knowledge requirements, 3
Block diagram, 8

C

Channel-specific diagnostics, 46
Configuration, 10
Control interface, 20, 28
Conversion time, 63
Cycle time, 62, 63

D

Definition
 Station status, 42
Disposal, 3

F

Feedback interface, 20, 28
Fiber-optic cable
 Order number, 65

I

Identification Data, 29
Identifier-related diagnostics, 44
Internet
 Service & Support, 4
Interrupts, 56
 Structure, 47

L

LED display, 33
Length of the diagnostics frame, 39

M

Master PROFIBUS address, 43
Module status, 45

O

Option handling
 Functional principle, 15
 parameter assignment, 18, 26
Prerequisites, 24

P

Parameters, 11
PII, 20, 28
PIQ, 20, 28
Plug adapters
 Order number, 65
Properties, 7

R

Reading out diagnostics, 39
Recycling, 3
Response time, 64
Response times, 59
 4 IQ-SENSE, 64
 analog input modules, 62
 analog output modules, 63
 digital input modules, 61
 digital output modules, 61
 For the ET 200S, 60
 Technological modules, 64

S

Scope
 Manual, 3
Service & Support, 4
Settling time, 63
SFC 13, 40
Simplex connectors
 Order number, 65
Slave diagnostics, 39, 41
Station status 1
 Structure, 42
Station status 2
 Structure, 43

- Station status 3
 - Structure, 43
- Station statuses 1 to 3, 42
- Status and error displays, 33
- STEP 7 user program, 40
- Structure, 47
 - Diagnostics interrupt, 49
 - Interrupts, 48
 - Process interrupt, 54

T

- Technical data, 9
- Technical Support, 4
- Terminal assignment, 8
- Training Center, 3

U

- Updating firmware, 10